

FLEXIBILITY
DELIVERED
WITH PASSION



SENAB

Färgmarkeringar och/eller symboler för hållbara alternativ i prislistan:

Mörkgrön markering eller symbol

Miljömärkt produkt – Möbler där hela den sammansatta varan har en typ 1 miljömärkning enligt ISO 14024 med Svanen, Möbelfakta, EU Ecolabel eller annan likvärdig märkning.

Ljusgrön markering eller symbol

Hållbarhetsmärkt produkt eller beståndsdel – Möbler där hela eller delar av den sammansatta varan är hållbarhetsmärkt, exempelvis med FSC, EU Ecolabel eller OEKO-TEX®. Leverantören ska kunna ge mer detaljerad information om vilka delar eller variationer som är hållbarhetsmärka vid begäran.

Orange markering eller symbol

Klimatberäknad produkt – Produkt med dokumenterad miljövarudeklaration (EPD) enligt ISO 14025.

Lila markering eller symbol

Produkt med återvunnet eller förnybart material (enligt definitionerna i ISO 14021). Leverantören ska kunna ge information om andel (%) återvunnet och/eller förnybart (biobaserat) vid begäran. Märkning av återvinningsbart material utgår.

Blå markering eller symbol

Demonterbar produkt – Produkt som är demonterbar till olika komponenter och beståndsdelar som i första hand möjliggör återbruk och i andra hand materialåtervinning när produkten nått sin fulla livslängd. Produkten ska vara designad för renovering, det vill säga att det ska vara enkelt att reparera och byta ut moduler, komponenter och beståndsdelar som slits över tid. Exempelvis ska ytskikt, som bordsskivor, textil och stoppning kunna tas isär, avlägsnas och ersättas med hjälp av vanligt förekommande manuella verktyg, ej specialverktyg. Enklare reparationer och utbytesarbeten ska kunna utföras av en lekman. Om det krävs fackmanakunskap för mer avancerade arbeten ska det framgå av anvisningarna som leverantören ska kunna ge vid begäran. Anvisningarna ska innehålla en sprängskiss, steg för steg beskrivning inklusive vilka verktyg som krävs samt hur möbelns ingående delar bör källsorteras.



Table of Content

Chairs

| | |
|--------------------------|----|
| 40/4 | 4 |
| Side chair | 4 |
| Side chair - upholstered | 5 |
| Arm chair | 6 |
| Arm chair - upholstered | 7 |
| Swivel | 8 |
| Swivel - upholstered | 9 |
| Bar and Lounge | 10 |
| Metal and Wood | 11 |
| SixE | 12 |
| 4-leg | 12 |
| 4-leg on castors | 13 |
| Sled | 14 |
| Barstool | 15 |
| Swivel | 16 |
| Learn | 17 |
| AS100 | 18 |
| The Tongue | 19 |
| Munkegaard | 20 |
| Accessories for chairs | 21 |
| Notes for chairs | 28 |
| <hr/> | |
| Upholstery collection | 30 |



Table of Content

| | |
|------------------------------|----|
| Tables | |
| Moveo | 32 |
| Training | 32 |
| Meeting | 33 |
| Conference, modular | 34 |
| Conference, stand alone | 35 |
| Modesty panel | 36 |
| Simpla | 37 |
| Tables | 37 |
| Modesty panel | 39 |
| Tempest | 40 |
| Flip top | 40 |
| Flip top café | 41 |
| Flip top bar | 42 |
| Fold | 43 |
| Fix | 44 |
| Fix bar | 45 |
| Fix café and lounge | 46 |
| Modesty panel | 47 |
| Tutor | 49 |
| Usu | 50 |
| AS table series | 51 |
| AS400 | 51 |
| AS500 | 52 |
| Other accessories for tables | 53 |
| Notes for tables | 56 |
| | |
| Finish overview | 58 |
| Sales Terms | 63 |
| Warranty | 67 |

40/4 side chair - polyamide

By David Rowland

Most people see the 40/4 as a pioneering design that has stood the test of time. We like to think of it as a legacy that continues to move you in new ways.

- 10 year warranty
- Stacks 40 chairs on a dolly
- EN 15373 / ANSI/BIFMA X5.1 – N7.1
- FSC/PEFC certified
- ISO 14025 EPD
- GreenTag^{Cert™}
- Health Product Declaration (HPD)
- **Quick ship - LINK**

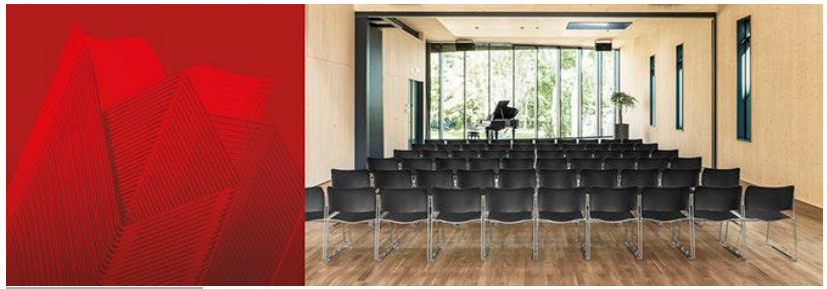

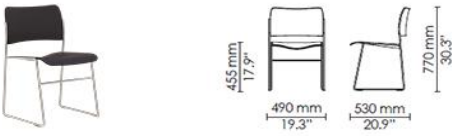
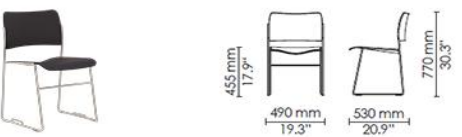
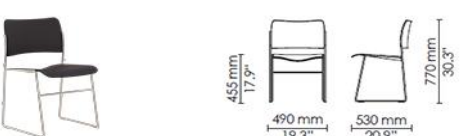
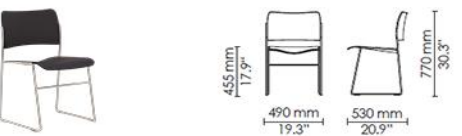
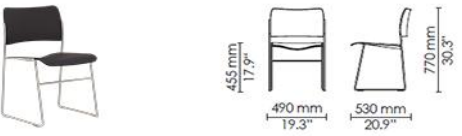
| | | POLYAMIDE (DPA) | |
|---|--------|--|------------|
| STANDARD FRAME COLOURS  B1 B6 B7 B9 B10 B30 RAL K5 colours available at customer request | | PA200 ● PA100 ● PA300 ○ PA110 ● PA250 ● PA260 ● PA320 ● PA360 ● PA380 ● PA370 ● | SEK SEK |
| Non linking (RA) | 6,5 kg |  | 2772 2984 |
| Brace linking (BA) | 6,6 kg |  | 3156 3368 |
| Eye Hook linking (EA) | 6,6kg |  | 3163 3375 |
| Dining height (DA)* | 6,5 kg |  | 3032 3244 |
| *Different seat angle compared to regular chair | | | |
| Side chair outdoor (DOARA) | 6,5 kg |  | 4152 4364 |

| | | |
|--|-------|-----|
| Felt glides | +118 | SEK |
| Fee per RAL K5 colour for frames (for one colour if below 200 pcs) | +2400 | SEK |

Price list 2023 - SEK excl. V.A.T. - Version 1.2

40/4 side chair upholstered

By David Rowland

Most people see the 40/4 as a pioneering design that has stood the test of time. We like to think of it as a legacy that continues to move you in new ways.

- 10 year warranty
- Stacks 25 chairs on a dolly
- EN 16139 / Ansi/Bifma X5.1
- FSC/PEFC certified
- ISO 14025 EPD
- GreenTag^{Cert™}
- **Quick ship - LINK**



STANDARD FRAME COLOURS



RAL K5 colours available at customer request

Non linking (RA) 6,3 kg

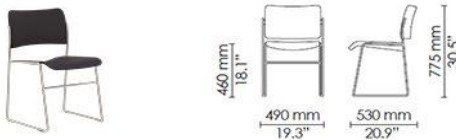

Brace linking (BA) 6,5 kg

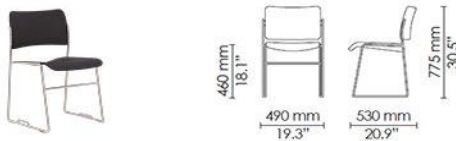

Eye Hook linking (EA) 6,5 kg

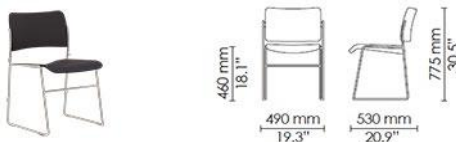

Dining height (DA)* 6,3 kg

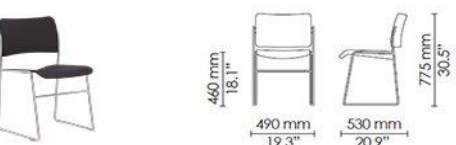

*Different seat angle compared to regular chair

| GROUP | SEAT UPHOLSTERED | | FULLY UPHOLSTERED (DUA) |
|-------------|------------------|-------|-------------------------|
| | POLYAMIDE (DSA) | | |
| | PA200 | PA100 | |
| | PA300 | PA110 | |
| | | PA250 | |
| | | PA260 | |
| | | PA320 | |
| | | PA360 | |
| | | PA380 | |
| | | PA370 | |
| | SEK | SEK | SEK |
| COM | 3553 | 3695 | 4035 |
| 1 | 3774 | 3916 | 4347 |
| 2 | 4074 | 4216 | 4777 |
| 3 | 4360 | 4502 | 5193 |
| 4 | 4789 | 4931 | 5805 |
| 5 | 4933 | 5075 | 6013 |
| COL | 4451 | 4593 | 5323 |
| LUBL | 4789 | 4931 | 5805 |
| LUCL | 5375 | 5517 | 6638 |
| LSL | 6286 | 6428 | 7939 |
| COM | 3943 | 4085 | 4425 |
| 1 | 4164 | 4306 | 4737 |
| 2 | 4464 | 4606 | 5167 |
| 3 | 4750 | 4892 | 5583 |
| 4 | 5179 | 5321 | 6195 |
| 5 | 5323 | 5465 | 6403 |
| COL | 4841 | 4983 | 5713 |
| LUBL | 5179 | 5321 | 6195 |
| LUCL | 5765 | 5907 | 7028 |
| LSL | 6676 | 6818 | 8329 |
| COM | 3943 | 4085 | 4425 |
| 1 | 4164 | 4306 | 4737 |
| 2 | 4464 | 4606 | 5167 |
| 3 | 4750 | 4892 | 5583 |
| 4 | 5179 | 5321 | 6195 |
| 5 | 5323 | 5465 | 6403 |
| COL | 4841 | 4983 | 5713 |
| LUBL | 5179 | 5321 | 6195 |
| LUCL | 5765 | 5907 | 7028 |
| LSL | 6676 | 6818 | 8329 |
| COM | 3813 | 3955 | 4295 |
| 1 | 4034 | 4176 | 4607 |
| 2 | 4334 | 4476 | 5037 |
| 3 | 4620 | 4762 | 5453 |
| 4 | 5049 | 5191 | 6065 |
| 5 | 5193 | 5335 | 6273 |
| COL | 4711 | 4853 | 5583 |
| LUBL | 5049 | 5191 | 6065 |
| LUCL | 5635 | 5777 | 6898 |
| LSL | 6546 | 6688 | 8199 |

Price list 2023 - SEK excl. V.A.T. - Version 1.2

Felt glides +118 SEK

Fee per RAL K5 colour for frames (for one colour if below 200 pcs) +2400 SEK

40/4 armchair - polyamide

By David Rowland

Most people see the 40/4 as a pioneering design that has stood the test of time. We like to think of it as a legacy that continues to move you in new ways.

- 10 year warranty
- Stacks 40 chairs on a dolly
- EN 15373 / ANSI/BIFMA X5.1 – N7.1
- FSC/PEFC certified
- ISO 14025 EPD
- GreenTag^{Cert™}
- 27% recycled plastic
- **Quick ship - LINK**

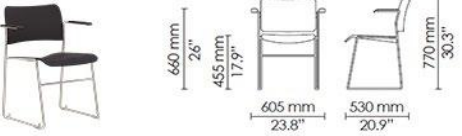
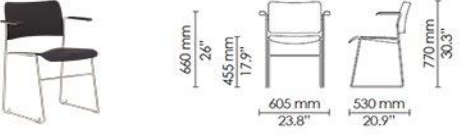
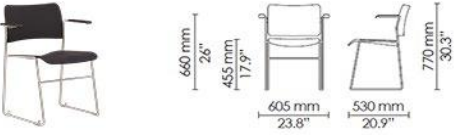
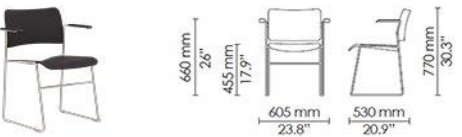

| | | POLYAMIDE (DPB) | |
|---|--|--------------------|--|
| STANDARD FRAME COLOURS  B1 B6 B7 B9 B10 B30 RAL K5 colours available at customer request | | PA200 ● PA300 ○ | PA100 ● PA110 ● PA250 ● PA260 ● PA320 ● PA360 ● PA380 ● PA370 ● |
| Non linking (RA) 7,7 kg  | | SEK | SEK |
| Dining height (DA)* 7,7 kg  | | 3839 | 4047 |
| *Different seat angle compared to regular chair Armlinking (J) 7,8 kg  | | 4100 | 4308 |
| Armchair outdoor (DOBRA) 7,7 kg  | | 4464 | 4672 |
| | | 5219 | 5431 |

Price list 2023 - SEK excl. V.A.T. - Version 1.2

| | |
|--|-----------|
| Felt glides | +118 SEK |
| Table surface protection | +120 SEK |
| Fee per RAL K5 colour for frames (for one colour if below 200 pcs) | +2400 SEK |

40/4 armchair upholstered

By David Rowland

Most people see the 40/4 as a pioneering design that has stood the test of time. We like to think of it as a legacy that continues to move you in new ways.

- 10 year warranty
- Stacks 25 chairs on a dolly
- EN 15373 / ANSI/BIFMA X5.1 – N7.1
- FSC/PEFC certified
- ISO 14025 EPD
- GreenTag^{Cert™}
- **Quick ship - LINK**



STANDARD FRAME COLOURS



B1 B6 B7 B9 B10 B30

RAL K5 colours available at customer request

Non linking (RA) 7,6 kg

Dining height (DA)* 7,6 kg

*Different seat angle compared to regular chair

Armlinking (J) 7,7 kg

| GROUP | SEAT UPHOLSTERED | | FULLY UPHOLSTERED | | |
|-------------|------------------|--|-------------------------|------------------------------|---------------|
| | POLYAMIDE (DSB) | | UPHOLSTERED (DUB) | | |
| | PA200 PA300 | PA100 PA110 PA250 PA260 PA320 PA360 PA380 PA370 | BLACK POLYAMIDE ARMREST | BLACK STAINED VENEER ARMREST | UPH. ARMRESTS |
| | SEK | SEK | SEK | SEK | SEK |
| COM | 4620 | 4763 | 5102 | 5527 | 5531 |
| 1 | 4841 | 4984 | 5414 | 5839 | 5974 |
| 2 | 5141 | 5284 | 5844 | 6269 | 6495 |
| 3 | 5427 | 5570 | 6260 | 6685 | 6989 |
| 4 | 5856 | 5999 | 6872 | 7297 | 7666 |
| 5 | 6000 | 6143 | 7080 | 7505 | 7991 |
| COL | 5518 | 5661 | 6390 | 6815 | 7054 |
| LUBL | 5856 | 5999 | 6872 | 7297 | 7666 |
| LUCL | 6442 | 6585 | 7705 | 8130 | 8850 |
| LSL | 7353 | 7496 | 9006 | 9431 | 10255 |
| COM | 4881 | 5024 | 5362 | 5787 | 5791 |
| 1 | 5102 | 5245 | 5674 | 6099 | 6234 |
| 2 | 5402 | 5545 | 6104 | 6529 | 6755 |
| 3 | 5688 | 5831 | 6520 | 6945 | 7249 |
| 4 | 6117 | 6260 | 7132 | 7557 | 7926 |
| 5 | 6261 | 6404 | 7340 | 7765 | 8251 |
| COL | 5779 | 5922 | 6650 | 7075 | 7314 |
| LUBL | 6117 | 6260 | 7132 | 7557 | 7926 |
| LUCL | 6703 | 6846 | 7965 | 8390 | 9110 |
| LSL | 7614 | 7757 | 9266 | 9691 | 10515 |
| COM | 5245 | 5388 | 5727 | 6152 | 6156 |
| 1 | 5466 | 5609 | 6039 | 6464 | 6599 |
| 2 | 5766 | 5909 | 6469 | 6894 | 7120 |
| 3 | 6052 | 6195 | 6885 | 7310 | 7614 |
| 4 | 6481 | 6624 | 7497 | 7922 | 8291 |
| 5 | 6625 | 6768 | 7705 | 8130 | 8616 |
| COL | 6143 | 6286 | 7015 | 7440 | 7679 |
| LUBL | 6481 | 6624 | 7497 | 7922 | 8291 |
| LUCL | 7067 | 7210 | 8330 | 8755 | 9475 |
| LSL | 7978 | 8121 | 9631 | 10056 | 10880 |

Price list 2023 - SEK excl. V.A.T. - Version 1.2

| | | |
|--|-------|-----|
| Felt glides | +118 | SEK |
| Table surface protection | +120 | SEK |
| Fee per RAL K5 colour for frames (for one colour if below 200 pcs) | +2400 | SEK |
| Fee per RAL K5 colour for veneer (for one colour if below 200 pcs) | +1100 | SEK |

40/4 swivel - polyamide

By David Rowland

Most people see the 40/4 as a pioneering design that has stood the test of time. We like to think of it as a legacy that continues to move you in new ways.

- 10 year warranty
- Castors or glides available
- Height adjustable
- Soft lane castor as an option
- FSC/PEFC certified
- GreenTag^{Cert™}
- 39% recycled plastic



| STANDARD FRAME COLOURS | | POLYAMIDE (DP) | |
|--|---------|--|------|
| <p>B1 B6 B7 B9 B10 B30</p> | | PA200 ● PA100 ● PA300 ○ PA110 ● PA250 ● PA260 ● PA320 ● PA360 ● PA380 ● PA370 ● | |
| RAL K5 colours available at customer request | | SEK | SEK |
| Side chair (DPESS) | 11,6 kg | | |
| | | 5180 | 5392 |
| Armchair (DPFSA) | 12,4 kg | | |
| | | 6260 | 6468 |

Price list 2023 - SEK excl. V.A.T. - Version 1.2

| | | |
|---|-------|-----|
| Soft lane castors | +118 | SEK |
| Fee per RAL K5 colour for frames (for one colour if below 200 pcs) | +2400 | SEK |

40/4 swivel upholstered

By David Rowland

Most people see the 40/4 as a pioneering design that has stood the test of time. We like to think of it as a legacy that continues to move you in new ways.

- 10 year warranty
- Castors or glides available
- Height adjustable
- Soft lane castor as an option
- FSC/PEFC certified
- ISO 14025 EPD
- GreenTag^{Cert™}

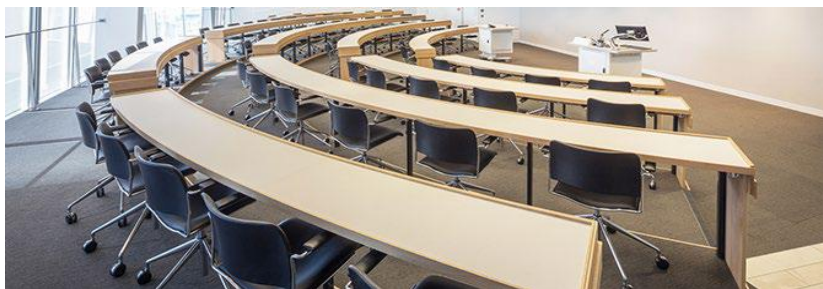

STANDARD FRAME COLOURS



RAL K5 colours available at customer request

Side chair (DUSS)

11,4 kg



Armchair (DUFSA)

12,2 kg



| GROUP | SEAT UPHOLSTERED | | FULLY UPHOLSTERED (DU) | | |
|-------------|------------------|---------|-------------------------|------------------------------|----------------|
| | POLYAMIDE (DS) | | BLACK POLYAMIDE ARMREST | BLACK STAINED VENEER ARMREST | W-W/O UPH. ARM |
| | PA200 ● | PA100 ● | | | |
| | PA300 ○ | PA110 ● | | | |
| | | PA250 ● | | | |
| | | PA260 ● | | | |
| | | PA320 ● | | | |
| | | PA360 ● | | | |
| | | PA380 ● | | | |
| | | PA370 ● | | | |
| | SEK | SEK | SEK | SEK | SEK |
| COM | 5961 | 6103 | N/A | N/A | 6442 |
| 1 | 6182 | 6324 | N/A | N/A | 6754 |
| 2 | 6482 | 6624 | N/A | N/A | 7184 |
| 3 | 6768 | 6910 | N/A | N/A | 7600 |
| 4 | 7197 | 7339 | N/A | N/A | 8212 |
| 5 | 7341 | 7483 | N/A | N/A | 8420 |
| COL | 6859 | 7001 | N/A | N/A | 7730 |
| LUBL | 7197 | 7339 | N/A | N/A | 8212 |
| LUCL | 7783 | 7925 | N/A | N/A | 9045 |
| LSL | 8694 | 8836 | N/A | N/A | 10346 |
| COM | 7028 | 7171 | 7510 | 7935 | 7939 |
| 1 | 7249 | 7392 | 7822 | 8247 | 8382 |
| 2 | 7549 | 7692 | 8252 | 8677 | 8903 |
| 3 | 7835 | 7978 | 8668 | 9093 | 9397 |
| 4 | 8264 | 8407 | 9280 | 9705 | 10074 |
| 5 | 8408 | 8551 | 9488 | 9913 | 10399 |
| COL | 7926 | 8069 | 8798 | 9223 | 9462 |
| LUBL | 8264 | 8407 | 9280 | 9705 | 10074 |
| LUCL | 8850 | 8993 | 10113 | 10538 | 11258 |
| LSL | 9761 | 9904 | 11414 | 11839 | 12663 |

Price list 2023 - SEK excl. V.A.T. - Version 1.2

| | | |
|--|-------|-----|
| Soft lane castors | +118 | SEK |
| Fee per RAL K5 colour for frames (for one colour if below 200 pcs) | +2400 | SEK |
| Fee per RAL K5 colour for veneer (for one colour if below 200 pcs) | +1100 | SEK |

40/4 barstool and lounge chair

By David Rowland

Most people see the 40/4 as a pioneering design that has stood the test of time. We like to think of it as a legacy that continues to move you in new ways.

- 10 year warranty
- Stacks 10 barstools
- Stacks 20 lounge chairs
- EN 15373 / ANSI/BIFMA X5.1
- FSC/PEFC certified
- ISO 14025 EPD
- GreenTag^{Cert™}



| STANDARD FRAME COLOURS | POLYAMIDE | | FULLY UPHOLSTERED | |
|--|----------------|--|-------------------|-------|
| | PA200 PA300 | PA100 PA110 PA250 PA260 PA320 PA360 PA380 PA370 | GROUP | PRICE |
| <p>B1 B6 B7 B9 B10 B30</p> <p>RAL K5 colours available at customer request</p> | SEK | SEK | | |
| Lounge chair (DVdra) 6 kg | | | | |
| | N/A | N/A | | |
| Barstool (DPCAA) 10,4 kg | | | | |
| | 5115 | 5327 | | |
| Barstool counter height (DPCCA) 9,2 kg | | | | |
| | 5115 | 5327 | | |
| Barstool outdoor (DOCCA) 10,4 kg | | | | |
| | 6494 | 6706 | | |

| GROUP | PRICE |
|-------|-------|
| COM | 5596 |
| 1 | 5908 |
| 2 | 6338 |
| 3 | 6754 |
| 4 | 7366 |
| 5 | 7574 |
| COL | 6884 |
| LUBL | 7366 |
| LUCL | 8199 |
| LSL | 9500 |
| COM | 6377 |
| 1 | 6689 |
| 2 | 7119 |
| 3 | 7535 |
| 4 | 8147 |
| 5 | 8355 |
| COL | 7665 |
| LUBL | 8147 |
| LUCL | 8980 |
| LSL | 10281 |
| COM | 6377 |
| 1 | 6689 |
| 2 | 7119 |
| 3 | 7535 |
| 4 | 8147 |
| 5 | 8355 |
| COL | 7665 |
| LUBL | 8147 |
| LUCL | 8980 |
| LSL | 10281 |

Price list 2023 - SEK excl. V.A.T. - Version 1.2

| | | |
|---|-------|-----|
| Felt glides | +118 | SEK |
| Fee per RAL K5 colour for frames (for one colour if below 200 pcs) | +2400 | SEK |
| Fee per RAL K5 colour for veneer (for one colour if below 200 pcs) | +1100 | SEK |



40/4 metal

By David Rowland

Most people see the 40/4 as a pioneering design that has stood the test of time. The 40/4 wood frame is an alternative to the original chair with its iconic steel rod sled frame

- 10 year warranty
- Stacks 25 chairs with wood frame
- Stacks 40 chairs in metal
- Wood frame also with seat upholstered
- EN 16139 (wood frame)
- FSC/PEFC certified
- GreenTag^{Cert™}

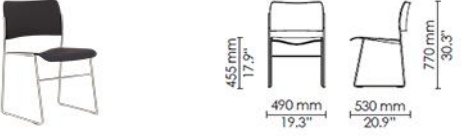
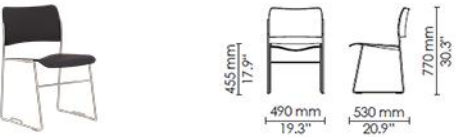

| | | |
|---|--------|---|
| | | METAL (DMA) |
| | | ME200  ME300  ME110  |
| | | SEK |
| Metal non linking (DMA-N) | 8,5 kg | |
|  | | 4063 |
| Metal w/ linking (DMA-Y) | 8,6 kg | |
|  | | 4269 |

Price list 2023 - SEK excl. V.A.T. - Version 1.2

| | | |
|--|-------|-----|
| Felt glides | +118 | SEK |
| Fee per RAL K5 colour for frames (for one colour if below 200 pcs) | +2400 | SEK |

SixE 4-leg

By PearsonLloyd

No matter how you look at SixE, it presents itself as a perfectly bold move – bending the rules of how comfortable a simple polypropylene shell chair can be.

- 10 year warranty
- SixE stacks up to 25 chairs on a dolly
- GreenTag^{Cert™}
- **Quick ship - LINK**
- Shells from recycled plastic available



| | POLYPROPYLENE (EPAMA/EPBMA) | | UPHOLSTERY | | | | |
|---|--------------------------------|---|-------------|-----------------|------------------|--------------|-----------------|
| | PP200 | <ul style="list-style-type: none"> ● PP100 ○ PP300 ● PP310 ● PP270 ● PP120 ● PP340 ● PP350 ● RECYCLED PP100 | GROUP | SEAT UPH. | | FULLY UPH. | |
| | | | | BLACK (EFA/EFB) | COLOUR (EFA/EFB) | NO ARM (EUA) | BLACK ARM (EUB) |
| Standard frame colours: Choose matching frame and shell colour without additional costs: RAL K5 colours available at customer request | SEK | SEK | | SEK | SEK | SEK | SEK |
| Sidechair (EPAMA) 5 kg | 2318 | 2579 | COM | 3570 | 3831 | 5849 | N/A |
| Sidechair with Quicklinking (EPAMA-R) 5 kg | 2741 | 3002 | 1 | 3747 | 4008 | 6380 | N/A |
| Armchair (EPBMA) 5,7 kg | 3000 | 3259 | 2 | 3924 | 4185 | 6911 | N/A |
| | | | 3 | 4066 | 4327 | 7336 | N/A |
| | | | 4 | 4302 | 4563 | 8045 | N/A |
| | | | 5 | 4526 | 4787 | 8718 | N/A |
| | | | COL | 4184 | 4445 | N/A | N/A |
| Armchair with armlinking (EPBMA-Y) 5,7 kg | 3123 | 3382 | LUBL | 4302 | 4563 | N/A | N/A |
| | | | LUCL | 4857 | 5118 | N/A | N/A |
| | | | LSL | 5459 | 5720 | N/A | N/A |
| | | | COM | 3993 | 4254 | 6272 | N/A |
| | | | 1 | 4170 | 4431 | 6803 | N/A |
| | | | 2 | 4347 | 4608 | 7334 | N/A |
| | | | 3 | 4489 | 4750 | 7759 | N/A |
| | | | 4 | 4725 | 4986 | 8468 | N/A |
| | | | 5 | 4949 | 5210 | 9141 | N/A |
| | | | COL | 4607 | 4868 | N/A | N/A |
| | | | LUBL | 4725 | 4986 | N/A | N/A |
| | | | LUCL | 5280 | 5541 | N/A | N/A |
| | | | LSL | 5882 | 6143 | N/A | N/A |
| | | | COM | 4313 | 4570 | N/A | 6531 |
| | | | 1 | 4490 | 4747 | N/A | 7062 |
| | | | 2 | 4667 | 4924 | N/A | 7593 |
| | | | 3 | 4809 | 5066 | N/A | 8018 |
| | | | 4 | 5045 | 5302 | N/A | 8727 |
| | | | 5 | 5269 | 5526 | N/A | 9400 |
| | | | COL | 4927 | 5184 | N/A | N/A |
| | | | LUBL | 5045 | 5302 | N/A | N/A |
| | | | LUCL | 5600 | 5857 | N/A | N/A |
| | | | LSL | 6202 | 6459 | N/A | N/A |
| | | | COM | 4436 | 4693 | N/A | 6654 |
| | | | 1 | 4613 | 4870 | N/A | 7185 |
| | | | 2 | 4790 | 5047 | N/A | 7716 |
| | | | 3 | 4932 | 5189 | N/A | 8141 |
| | | | 4 | 5168 | 5425 | N/A | 8850 |
| | | | 5 | 5392 | 5649 | N/A | 9523 |
| | | | COL | 5050 | 5307 | N/A | N/A |
| | | | LUBL | 5168 | 5425 | N/A | N/A |
| | | | LUCL | 5723 | 5980 | N/A | N/A |
| | | | LSL | 6325 | 6582 | N/A | N/A |

Price list 2023 - SEK excl. V.A.T. - Version 1.2

Felt glides +123 SEK

Fee per RAL K5 colour for frames (for one colour if below 200 pcs) +2400 SEK





SixE 4-leg on castors

By PearsonLloyd

No matter how you look at SixE, it presents itself as a perfectly bold move – bending the rules of how comfortable a simple polypropylene shell chair can be.

- 10 year warranty
- SixE stacks up to 15 chairs on a dolly
- GreenTag^{Cert™}
- Shells from recycled plastic available



| Standard frame colours:  B1 B6 B7 B9 B10 B30 Choose matching frame and shell colour without additional costs:  | POLYPROPYLENE (EPASB/EPBSD) | | UPHOLSTERY | | | | |
|--|--------------------------------|--|-------------|-----------------|------------------|--------------|-----------------|
| | PP200 ● | PP100 ● PP300 ● PP310 ● PP270 ● PP120 ● PP340 ● PP350 ● RECYCLED PP100 ● | GROUP | SEAT UPH. | | FULLY UPH. | |
| | | | | BLACK (EFA/EFB) | COLOUR (EFA/EFB) | NO ARM (EUA) | BLACK ARM (EUB) |
| RAL K5 colours available at customer request | SEK | SEK | | SEK | SEK | SEK | SEK |
| Sidechair (EPASB) 5,2 kg  | 3600 | 3861 | COM | 4968 | 5229 | 7131 | N/A |
| | | | 1 | 5145 | 5406 | 7662 | N/A |
| | | | 2 | 5322 | 5583 | 8193 | N/A |
| | | | 3 | 5464 | 5725 | 8618 | N/A |
| | | | 4 | 5700 | 5961 | 9327 | N/A |
| | | | 5 | 5924 | 6185 | 10000 | N/A |
| | | | COL | 5582 | 5843 | N/A | N/A |
| | | | LUBL | 5700 | 5961 | N/A | N/A |
| | | | LUCL | 6255 | 6516 | N/A | N/A |
| | | | LSL | 6857 | 7118 | N/A | N/A |
| Armchair (EPBSD) 6,1 kg  | 4281 | 4540 | COM | 5712 | 5969 | N/A | 7812 |
| | | | 1 | 5889 | 6146 | N/A | 8343 |
| | | | 2 | 6066 | 6323 | N/A | 8874 |
| | | | 3 | 6208 | 6465 | N/A | 9299 |
| | | | 4 | 6444 | 6701 | N/A | 10008 |
| | | | 5 | 6668 | 6925 | N/A | 10681 |
| | | | COL | 6326 | 6583 | N/A | N/A |
| | | | LUBL | 6444 | 6701 | N/A | N/A |
| | | | LUCL | 6999 | 7256 | N/A | N/A |
| | | | LSL | 7601 | 7858 | N/A | N/A |

Price list 2023 - SEK excl. V.A.T. - Version 1.2

Soft lane castors +123 SEK

Fee per RAL K5 colour for frames (for one colour if below 200 pcs) +2400 SEK

SixE sled





By PearsonLloyd

No matter how you look at SixE, it presents itself as a perfectly bold move – bending the rules of how comfortable a simple polypropylene shell chair can be.

- 10 year warranty
- SixE stacks up to 25 chairs on a dolly
- GreenTag^{Cert™}
- **Quick ship - LINK**
- Shells from recycled plastic available

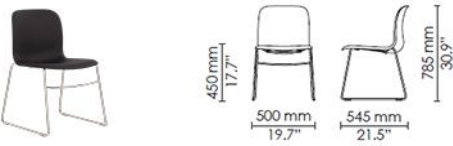

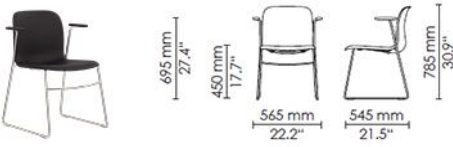
Photo: Steve Hall / Architect: Eastlake Studio

| Standard frame colours:  RAL K5 colours available at customer request | POLYPROPYLENE (EPA/EPB) | | UPHOLSTERY | | | | |
|--|----------------------------|------|------------|------------------------|-------------------------|-----------------|--------------------|
| | SEK | SEK | GROUP | SEAT UPH. | | FULLY UPH. | |
| | | | | BLACK (EFA/ EFB) | COLOUR (EFA/ EFB) | NO ARM (EUA) | BLACK ARM (EUB) |
| Sidechair (EPARB) 6 kg  | 2822 | 3083 | COM | 4120 | 4381 | 6354 | N/A |
| Sidechair with bracelinking (EPABB) 6.2 kg  | 3245 | 3506 | COM | 4581 | 4842 | 6776 | N/A |
| Armchair (EPBRB) 7.3 kg  | 3504 | 3763 | COM | 4864 | 5121 | N/A | 7035 |
| Armchair with armlinking (EPBRB-Y) 7.3 kg  | 3627 | 3886 | COM | 4987 | 5244 | N/A | 7158 |
| | | | 1 | 5164 | 5421 | N/A | 7689 |
| | | | 2 | 5341 | 5598 | N/A | 8220 |
| | | | 3 | 5483 | 5740 | N/A | 8645 |
| | | | 4 | 5719 | 5976 | N/A | 9354 |
| | | | 5 | 5943 | 6200 | N/A | 10027 |
| | | | COL | 5601 | 5858 | N/A | N/A |
| | | | LUBL | 5719 | 5976 | N/A | N/A |
| | | | LUCL | 6274 | 6531 | N/A | N/A |
| | | | LSL | 6876 | 7133 | N/A | N/A |

Price list 2023 - SEK excl. V.A.T. - Version 1.2

| | | |
|---|-------|-----|
| Felt glides | +123 | SEK |
| Fee per RAL K5 colour for frames (for one colour if below 200 pcs) | +2400 | SEK |

SixE barstool

By PearsonLloyd

No matter how you look at SixE, it presents itself as a perfectly bold move – bending the rules of how comfortable a simple polypropylene shell chair can be.

- 10 year warranty
- SixE stacks up to 10 chairs on a dolly
- GreenTag^{Cert™}
- Shells from recycled plastic available



| Standard frame colours: B1 B6 B7 B9 B10 B30 RAL K5 colours available at customer request | POLYPROPYLENE (EPC) | | UPHOLSTERY | | | |
|--|---------------------|------|------------|-------------|--------------|------------------|
| | SEK | SEK | GROUP | SEAT UPH. | | FULLY UPH. (EUC) |
| | | | | BLACK (EFC) | COLOUR (EFC) | |
| Barstool 4 Leg (EPCAO) 7,3 kg | 4186 | 4447 | | SEK | SEK | SEK |
| Barstool 4 Leg counter height (EPCAP) 5,2 kg | 4186 | 4447 | | SEK | SEK | SEK |
| Barstool Sled frame (EPCAM) 9,5 kg | 4690 | 4951 | | SEK | SEK | SEK |

| GROUP | BLACK (EFC) | COLOUR (EFC) | FULLY UPH. (EUC) |
|-------------|-------------|--------------|------------------|
| | SEK | SEK | SEK |
| COM | 5607 | 5868 | 7717 |
| 1 | 5784 | 6045 | 8248 |
| 2 | 5961 | 6222 | 8779 |
| 3 | 6103 | 6364 | 9204 |
| 4 | 6339 | 6600 | 9913 |
| 5 | 6563 | 6824 | 10586 |
| COL | 6221 | 6482 | N/A |
| LUBL | 6339 | 6600 | N/A |
| LUCL | 6894 | 7155 | N/A |
| LSL | 7496 | 7757 | N/A |
| COM | 5607 | 5868 | 7717 |
| 1 | 5784 | 6045 | 8248 |
| 2 | 5961 | 6222 | 8779 |
| 3 | 6103 | 6364 | 9204 |
| 4 | 6339 | 6600 | 9913 |
| 5 | 6563 | 6824 | 10586 |
| COL | 6221 | 6482 | N/A |
| LUBL | 6339 | 6600 | N/A |
| LUCL | 6894 | 7155 | N/A |
| LSL | 7496 | 7757 | N/A |
| COM | 6158 | 6419 | 8221 |
| 1 | 6335 | 6596 | 8752 |
| 2 | 6512 | 6773 | 9283 |
| 3 | 6654 | 6915 | 9708 |
| 4 | 6890 | 7151 | 10417 |
| 5 | 7114 | 7375 | 11090 |
| COL | 6772 | 7033 | N/A |
| LUBL | 6890 | 7151 | N/A |
| LUCL | 7445 | 7706 | N/A |
| LSL | 8047 | 8308 | N/A |

Price list 2023 - SEK excl. V.A.T. - Version 1.2

Felt glides +123 SEK

Fee per RAL K5 colour for frames (for one colour if below 200 pcs) +2400 SEK

SixE swivel

By PearsonLloyd

No matter how you look at SixE, it presents itself as a perfectly bold move. – bending the rules of how comfortable a simple polypropylene shell chair can be.

- 10 year warranty
- Design for Disassembly
- GreenTag^{Cert™}
- Shells from recycled plastic available



| | POLYPROPYLENE (EPEES/EPFES) | | UPHOLSTERY | | | | |
|--|--------------------------------|---|------------|------------------------|-------------------------|-----------------------------|-------|
| | PP200 ● | PP100 ● PP300 ○ PP310 ● PP270 ● PP120 ● PP340 ● PP350 ● | GROUP | SEAT UPH. | | FULLY UPH. (EFSES/EFTES) | |
| | | | | BLACK (EPO/ EPP) | COLOUR (EPO/ EPP) | | |
| Standard frame colours: ● B10 BAIN - HOWE Grey | SEK | SEK | | SEK | SEK | SEK | |
| Sidechair | 7,2 kg | 3272 | 3533 | | | | |
| Armchair | 8,3 kg | 3954 | 4213 | | | | |
| | | | | SEK | SEK | SEK | |
| | | | | COM | 4611 | 4872 | 6803 |
| | | | | 1 | 4788 | 5049 | 7334 |
| | | | | 2 | 4965 | 5226 | 7865 |
| | | | | 3 | 5107 | 5368 | 8290 |
| | | | | 4 | 5343 | 5604 | 8999 |
| | | | | 5 | 5567 | 5828 | 9672 |
| | | | | COL | 5225 | 5486 | N/A |
| | | | | LUBL | 5343 | 5604 | N/A |
| | | | | LUCL | 5898 | 6159 | N/A |
| | | | | LSL | 6500 | 6761 | N/A |
| | | | | COM | 5355 | 5612 | 7485 |
| | | | | 1 | 5532 | 5789 | 8016 |
| | | | | 2 | 5709 | 5966 | 8547 |
| | | | | 3 | 5851 | 6108 | 8972 |
| | | | | 4 | 6087 | 6344 | 9681 |
| | | | | 5 | 6311 | 6568 | 10354 |
| | | | | COL | 5969 | 6226 | N/A |
| | | | | LUBL | 6087 | 6344 | N/A |
| | | | | LUCL | 6642 | 6899 | N/A |
| | | | | LSL | 7244 | 7501 | N/A |

Price list 2023 - SEK excl. V.A.T. - Version 1.2

Soft lane castors +123 SEK



SixE Learn

By PearsonLloyd

No matter how you look at SixE, it presents itself as a perfectly bold move – bending the rules of how comfortable a simple polypropylene shell chair can be.

- 5 year warranty
- Design for Disassembly
- Chair for active learning environments, classrooms and higher education
- GreenTag^{Cert™}
- Shells from recycled plastic available



| Standard frame colours: B10 BAIN - HOWE Grey | POLYPROPYLENE (EPO/EPP) | | UPHOLSTERY | | | |
|--|----------------------------|---|-------------|------------------------|-------------------------|-----------------------------|
| | PP200 ● | PP100 ● PP300 ○ PP310 ● PP270 ● PP120 ● PP340 ● PP350 ● | GROUP | SEAT UPH. | | FULLY UPH. (EFQ/ EFR) |
| | | | | BLACK (EFO/ EFP) | COLOUR (EFO/ EFP) | |
| | RECYCLED PP100 ● | SEK | | SEK | SEK | |
| Learn side chair  11,7 kg | 6204 | 6422 | COM | 7809 | 8027 | 9735 |
| | | | 1 | 7986 | 8204 | 10266 |
| | | | 2 | 8163 | 8381 | 10797 |
| | | | 3 | 8305 | 8523 | 11222 |
| | | | 4 | 8541 | 8759 | 11931 |
| | | | 5 | 8765 | 8983 | 12604 |
| | | | COL | 8423 | 8641 | N/A |
| | | | LUBL | 8541 | 8759 | N/A |
| | | | LUCL | 9096 | 9314 | N/A |
| | | | LSL | 9698 | 9916 | N/A |
| Learn armchair  12,7 kg | 6885 | 7144 | COM | 8552 | 8811 | 10416 |
| | | | 1 | 8729 | 8988 | 10947 |
| | | | 2 | 8906 | 9165 | 11478 |
| | | | 3 | 9048 | 9307 | 11903 |
| | | | 4 | 9284 | 9543 | 12612 |
| | | | 5 | 9508 | 9767 | 13285 |
| | | | COL | 9166 | 9425 | N/A |
| | | | LUBL | 9284 | 9543 | N/A |
| | | | LUCL | 9839 | 10098 | N/A |
| | | | LSL | 10441 | 10700 | N/A |

Price list 2023 - SEK excl. V.A.T. - Version 1.2

| | | |
|-------------------|------|-----|
| Soft lane castors | +123 | SEK |
| Bag hook* | +245 | SEK |
| Cupholder | +286 | SEK |

AS100

By Andreas Störiko

The AS series is highly inspired and highly functional. Combining elegance and utility with true mobility, the family of nesting chairs and tables leaves room for all imaginable purposes.

- 10 year warranty
- Lightweight and space-saving
- Easy to link multiple chairs for relocation
- Weight activated brake castors
- Stacks horizontally as many chairs as wanted
- FSC certified
- Return swivel mechanism with 4 positions

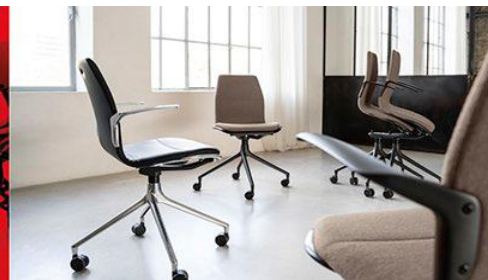
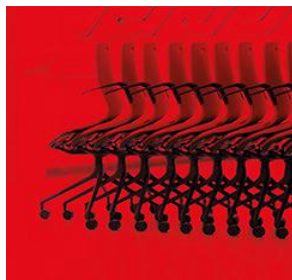

STANDARD ARMRESTS, SEATBAR AND BASE COLOURS



 B6 B7 B51

Side chair (CBBS/CABS) 10,3 kg

Armchair (CBBA/CABA) 11,2 kg

| GROUP | FULLY UPHOLSTERED (DU) |
|-------------|------------------------|
| | SEK |
| COM | 9285 |
| 1 | 9708 |
| 2 | 10130 |
| 3 | 10635 |
| 4 | 11398 |
| 5 | 11889 |
| COL | 11085 |
| LUBL | 11398 |
| LUCL | 13525 |
| LSL | 16102 |
| COM | 10062 |
| 1 | 10485 |
| 2 | 10907 |
| 3 | 11412 |
| 4 | 12175 |
| 5 | 12666 |
| COL | 11862 |
| LUBL | 12175 |
| LUCL | 14302 |
| LSL | 16879 |

Price list 2023 - SEK excl. V.A.T. - Version 1.1

Soft castors for hard floors +123 SEK

The Tongue

By Arne Jacobsen

The Tongue chair moved us from the very beginning. We fell truly, madly, deeply in love with this visionary yet playful design from 1955.

- Chair's aesthetics exactly as Jacobsen specified
- Extra strength provided through precise engineering
- 5 year guarantee
- All parts can be dismantled and recycled
- FSC certified



| | | UPHOLSTERED (GUA) | |
|--|--|-------------------|-------------------------------|
| | | DivinaMD | Savanne* |
| Please note that veneer is a natural material - differences in structure and colour may occur. STANDARD FRAME COLOURS  B1 B7 B30 RAL K5 colours available at customer request 4-Leg (MC) | | 613 | 330 |
| | | 813 | 302 |
| | | 433 | 314 |
| | | 453 | *MOQ 4 pcs per 1 colour |
| | | SEK | SEK |
| | | 10167 | 15607 |

Price list 2023 - SEK excl. V.A.T. - Version 1.1

Munkegaard chair

By Arne Jacobsen

The Munkegaard chair is a controversial design that turns heads as much today as it did when it was created in 1955. It offers easy functionality while maintaining a strong visual identity.

- The epitome of modernist design by Jacobsen
- Stacks 20 chairs on a dolly
- Stacks 15 chairs in upholstery on a dolly
- 5 year guarantee
- All parts can be dismantled and recycled
- FSC certified



Please note that veneer is a natural material - differences in structure and colour may occur.
STANDARD FRAME COLOURS



RAL K5 colours available at customer request
4-Leg (MB)



Barstool Seating height 775 mm (AE)



Barstool Seating height 630 mm (AF)



| SEAT UPH. (RRA) | FULLY UPH. (RUA) |
|--------------------|---------------------|
| GROUP | SEK |
| COM | 7090 |
| 1 | 7295 |
| 2 | 7704 |
| 3 | 8235 |
| 4 | 8644 |
| 5 | 9381 |
| COL | 8522 |
| LBBL | 9381 |
| LSL | 13594 |
| LPCL | 10894 |
| COM | 9544 |
| 1 | 9749 |
| 2 | 10158 |
| 3 | 10689 |
| 4 | 11098 |
| 5 | 11835 |
| COL | 10976 |
| LBBL | 11835 |
| LSL | 16048 |
| LPCL | 13348 |
| COM | 9544 |
| 1 | 9749 |
| 2 | 10158 |
| 3 | 10689 |
| 4 | 11098 |
| 5 | 11835 |
| COL | 10976 |
| LBBL | 11835 |
| LSL | 16048 |
| LPCL | 13348 |

Price list 2023 - SEK excl. V.A.T. - Version 1.2

Accessories

40/4 Writing tablet

Most people see the 40/4 as a pioneering design that has stood the test of time. We like to think of it as a legacy that continues to move you in new ways.

All accessories are recommended for chrome frames only.



| Writing tablet without or with cupholder | | |
|--|---------|--------------------|
| | | Per Piece |
| Writing tablet without cupholder 40/4 writing tablet, chrome frame, 10 mm compact laminate Left and right version is available | | SEK |
| No Cupholder | Black | 2277 |
| No Cupholder | White | 2277 |
| Cupholder | Black | 2591 |
| Cupholder | White | 2591 |
| 40/4 and SixE Transporter for writing tablets | | |
| Writing tablet dolly, up to 18 pcs. Dolly with 3 boxes, length: 410 mm, depth: 610 mm, height: 1400 mm. | | Per Transporter |
| Writing tablet dolly, up to 36 pcs. Double dolly with 6 boxes, length: 810 mm, depth: 610 mm, height: 1400 mm. | | |
| | | SEK |
| 18 Pcs | 3 boxes | 7554 |
| 36 pcs | 6 boxes | 14780 |



Price list 2023 - SEK excl. V.A.T. - Version 1.1













Accessories

40/4 Linking

Most people see the 40/4 as a pioneering design that has stood the test of time. We like to think of it as a legacy that continues to move you in new ways.

All accessories are recommended for chrome frames only.



| | | |
|---|-----------|--|
| <p style="text-align: center;">LD linking</p> | Per Piece |   |
| <p>Width between seats: 65 mm. Linking side chair to side chair; allows to link chairs in a straight line.</p> | SEK | |
| <p>40/4 linking device LD1H in chrome</p> | 340 | |
| <p>Width between seats: 125 mm. Linking: side chair to side chair; side chair to armchair; allows to link chairs in a straight line.</p> | |   |
| <p>40/4 linking device LD2H in chrome</p> | 453 | |
| <p>Width between seats: 185 mm. Linking: side chair to side chair; side chair to armchair; armchair to armchair; allows to link chairs in a straight line.</p> | |   |
| <p>40/4 linking device LD3H in chrome</p> | 510 | |
| <p>Width between seats: 80 mm. Linking side chair to side chair; allows to form the arc of chairs; the radius is adjustable, 0-12 degrees.</p> | |   |
| <p>40/4 radius linking device LD2RL in chrome</p> | 566 | |
| <p>Width between seats: 202 mm. Linking armchairs with writing tablets to armchairs with writing tablets; allows to link chairs in a straight line.</p> | |   |
| <p>40/4 linking device LD4S in chrome</p> | 651 | |
| <p>Width between seats: 70 mm. Linking side chair to side chair; allows to link chairs in a straight line. Recommended for public spaces where EN 14703 is a requirement.</p> | |   |
| <p>40/4 safety linking device LD5S in chrome</p> | 682 | |

Price list 2023 - SEK excl. V.A.T. - Version 1.1

Accessories

40/4 Dolly and Glides

Most people see the 40/4 as a pioneering design that has stood the test of time. We like to think of it as a legacy that continues to move you in new ways.

All accessories are recommended for chrome frames only.



| Dollies | | Per Piece |
|---|-------------|-----------|
| All accessories recommended for chrome frames only. Dollies suit side chairs and arm chairs in polyamide, veneer, or full upholstery. For dollies to other versions of the 40/4 chair - please ask HOWE | | SEK |
| Hook/eye, fin linking or without linking | DLYSSAASF10 | 6661 |
| Brace linking or wood frame | DLYSSBCSF10 | 6661 |
| Double dolly | | 15994 |
| Triple dolly | | 21716 |
| Quatro dolly | | 24883 |



| Extra glides with felt | | Per Piece |
|---|--|-----------|
| | | SEK |
| For hook/eye and fin-linking chairs on chrome frames | | |
| Transparent female glides with felt with screws | | 57 |
| Transparent male glides with felt with screws | | 57 |
| Transparent regular glides with felt | | 57 |
| For non-linking chairs; for linking armchairs and for brace-linking side chairs | | |
| Transparent regular glides with felt for both chrome and painted frames | | 57 |
| Transparent bar glides with felt for both chrome and painted frames | | 57 |



| Extra glides without felt | | Per Piece |
|---|--|-----------|
| | | SEK |
| For hook/eye and fin-linking chairs on chrome frames | | |
| Transparent female glides without felt with screws | | 42 |
| Transparent male glides without felt with screws | | 42 |
| Transparent regular glides without felt | | 42 |
| For non-linking chairs; for linking armchairs and for brace-linking side chairs | | |
| Transparent regular glides without felt for chrome frames | | 42 |
| Transparent regular glides without felt for painted frames | | 42 |
| Transparent bar glides with felt for both chrome and painted frames | | 42 |



Accessories

40/4 Linking items and book holders

Most people see the 40/4 as a pioneering design that has stood the test of time. We like to think of it as a legacy that continues to move you in new ways.

All accessories are recommended for chrome frames only.



| | | |
|--|------|--|
| LD linking continued | | |
| Per Piece | | |
| Width between seats: 70 mm. Linking side chair to side chair; allows to link chairs in a straight line. Recommended for public spaces where EN 14703 is a requirement. | | |
| SEK | | |
| 40/4 safety linking device LD55 | 772 | |
| Cup holder for 40/4 safety linking device LD55 | 87 | |
| Numbering for 40/4 safety linking device LD55 | 87 | |
| Linking tool | | |
| 40/4 Linking tool | | |
| In chrome. An aid to the linking/unlinking operation of side chairs with integrated linking. | | |
| Linking tool (for side chairs with integrated linking) | 382 | |
| Row spacer bar | | |
| In HOWE grey powdercoating with rubber lock, allows a 350 mm aisle between rows. | | |
| Row spacer bar for armchairs, 350 mm distance between the rows | 665 | |
| Row spacer bar for side chairs, 350 mm distance between the rows | 665 | |
| Bookholders | | |
| 40/4 book rack in chrome | | |
| Book rack (for side chairs and armchairs) | 1062 | |
| Hymn book holder | | |
| In chrome, 120 mm high and 175 mm long; 154 mm wide (distance between front legs of chairs) with integrated linking. Note! Hymn book holder does not work with the writing tablet. | | |
| Hymn book holder (for side chairs and armchairs, non-linking) | 538 | |

Price list 2023 - SEK excl. V.A.T. - Version 1.1

Accessories

40/4 Numbering tag

Most people see the 40/4 as a pioneering design that has stood the test of time. We like to think of it as a legacy that continues to move you in new ways.

All accessories are recommended for chrome frames only.



| |
|---|
| Numbering tags for row and seat |
| The price of one numbering tag. The start-up fee is 300 SEK. |
| 40/4 Row/seat numbering tag |

| |
|-----------|
| Per Piece |
| SEK |
| 522 |

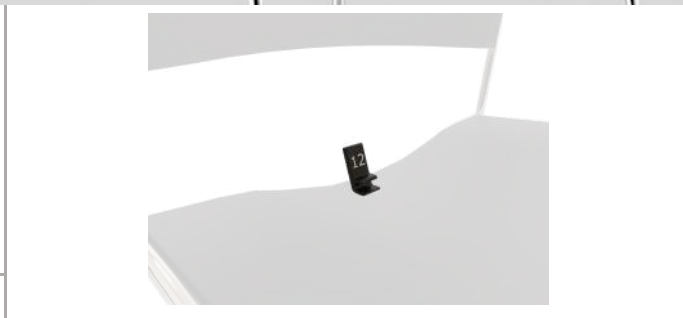



Price list 2023 - SEK excl. V.A.T. - Version 1.1

Accessories

SixE Writing tablet and Dolly

No matter how you look at SixE, it presents itself as a perfectly bold move – bending the rules of how comfortable a simple polypropylene shell chair can be.



| | | | | |
|--|--------------------|----------------------------|---|------|
| Writing tablet without or with cupholder | | Per Piece SEK |  | |
| Writing tablet without cupholder SixE writing tablet, chrome frame, 10 mm compact laminate Left and right version is available | | | | |
| No Cupholder | Black | | | 2291 |
| No Cupholder | White | | | 2291 |
| Cupholder | Black | | | 2605 |
| Cupholder | White | | | 2605 |
| 40/4 and SixE Transporter for writing tablets | | Per Transporter SEK |  | |
| Writing tablet dolly, up to 18 pcs. Dolly with 3 boxes, length: 410 mm, depth: 610 mm, height: 1400 mm. | | | | |
| Writing tablet dolly, up to 36 pcs. Double dolly with 6 boxes, length: 810 mm, depth: 610 mm, height: 1400 mm. | | | | |
| 18 Pcs | 3 boxes 404WTDLY01 | | | 7554 |
| 36 pcs | 6 boxes 404WTDLY02 | 14780 | | |
| Dolly for SixE 4-leg and sled | | Per Dolly SEK |  | |
| Single HOWE grey dolly with multidirectional castors Accommodates up to 25 chairs. | | | | |
| 25 chairs | 22920010 | 9901 | | |



Price list 2023 - SEK excl. V.A.T. - Version 1.1

Accessories

Munkegaard

The Munkegaard chair is a controversial design that turns heads as much today as it did when it was created in 1955. It offers easy functionality while maintaining a strong visual identity.



| | | |
|---|-----------------------------------|---|
| <p>Linking for side chair</p> | <p>Per Piece</p> <p>SEK</p> |  |
| <p>Linking for side chairs (quick linking)</p> | | |
| <p>No Cupholder 22011</p> | <p>410</p> | |
| <p>Loose stacking pan (For upholstered chairs)</p> | <p>Per Transporter</p> <p>SEK</p> |  |
| <p>The stacking pan prevents stacking marks in the upholstery.</p> | | |
| <p>36 pcs 22007</p> | <p>198</p> | |
| <p>Dolly</p> | <p>Per Dolly</p> <p>SEK</p> |  |
| <p>Single HOWE grey dolly with multidirectional castors Accommodates up to 20 chairs.</p> | | |
| <p>25 chairs 22920010</p> | <p>9901</p> | |

Price list 2023 - SEK excl. V.A.T. - Version 1.1

Notes for chairs

Price list 2023 - SEK excl. V.A.T. - Version 1.1

General

HOWE standard delivery times in EU are usually: Chairs 4-6 weeks, Tables 5-7 weeks.

In case of large quantities and/or customized products delivery time will be determined on a case-by-case basis.

The following products may have a slightly longer lead time so please ask HOWE:

- 40/4: Slim Armchairs, Dining height, Barstools, Veneer (other than Walnut/Oak/Black Stained), Xtra, Lounge, Wood
- SixE: 4-leg on castors, Brace-linking, Barstools
- Munkegaard: White Frame
- Tongue: White Frame
- AS100 upholstered

For chairs with upholstery, the lead time starts being counted once fabric reaches the production line.

We recommend linking only for chrome frames.

Frame colours from RAL K5 colour card are available. For quantities < 200 chairs the colour fee is 2400 SEK per RAL colour. For quantities ≥ 200 chairs there is no fee. Visual impressions of particular RAL may differ on various surfaces. Preparing product's sample(s) is compulsory. Lead time to be confirmed by HOWE CS.

Stained veneer is possible with RAL colours from RAL K5 colour card. For quantities < 200 chairs the colour fee is 1100 SEK per RAL colour. For quantities ≥ 200 chairs there is no fee. Visual impression of particular RAL may differ on various surfaces. Preparing product's sample(s) is compulsory. Lead time to be confirmed by HOWE CS.

We recommend only stacking chairs with chrome frame.

Veneer is a natural material - differences in structure and colour may occur.

Upholstered armrests are as standard in the same fabric/leather type and colour as the seat and the back.

Savanne leather: Minimum 4 chairs per colour per order required.

Soft castors are recommended for hard floors, hard castors are recommended for soft floors.

40/4

Table surface protection protects the table surface when the chairs are hung up; it may be used only for non-linking chairs.

Please be aware that extra glides are not available for wooden frames.

40/4 can be stacked on a single, double, triple or quarto dolly. Double, triple, and quarto can only be used with hook/eye linking.

As standard chair top frame and its swivel base are of the same colour but be aware that they are always matched by the chrome gas lift.

Glides for linking side chairs; the whole set for one linking side chair comprises of one male glide and one female glide at the front part of the frame (reinforcing the linking in the front part of the chair frame) plus two regular glides at the rear part of the frame; whether these are glides with or without felt depends only on customer's needs.

Regular glides are suitable for non-linking side chairs, for all types of armchairs and for lounge chairs; the whole set comprises of four clear regular glides per chair.

Glides for barstool with both chrome and painted frames; the whole set comprises of four regular glides per chair.

MN1

Fixed seating height - there is no possibility to install both height adjustable and return mechanism together.

Gas lift is black for black base and chrome for polished aluminium base.

Munkegaard

If upholstered chairs are to be stacked, please order the lose stacking pan to prevent stacking marks in the upholstery.

SixE

Bag hook is recommended only for polypropylene backs.

Fabric suitability

Standard collection of the carefully selected fabrics suitable for the HOWE products. They were all thoroughly tested, therefore we can guarantee these textiles meet our highest standards. Please check here which fabrics are dedicated to each of our product. If you're looking for a solution that reaches beyond standard options, please contact HOWE Customer Service.



| Supplier | Fabric's name | Supplier's fabric card EMEA | 40/4 | Munkegaard | SixE | Tongue | AS100 | Price gr.Sweden |
|----------|-----------------|-----------------------------|------|------------|------|--------|-------|-----------------|
| Gabriel | Cura | link | ✓ | ✓ | ✓ | ✓ | ✓ | 1 |
| Gabriel | Event | link | ✓ | ✓ | ✓ | ✓ | ✓ | 1 |
| Gabriel | Fighter | link | ✓ | X | | X | | 1 |
| Camira | Main Line Plus | link | ✓ | X | ✓ | ✓ | ✓ | 1 |
| Camira | Oceanic | link | ✓ | ✓ | ✓ | ✓ | X | 1 |
| Camira | Rivet | link | ✓ | ✓ | ✓ | ✓ | X | 1 |
| Gabriel | Step | link | ✓ | X | ✓ | X | X | 1 |
| Gabriel | Step Melange | link | ✓ | ✓ | ✓ | X | ✓ | 1 |
| Camira | Main Line Flax | link | ✓ | ✓ | ✓ | ✓ | ✓ | 2 |
| Gabriel | Crisp | link | ✓ | | ✓ | X | ✓ | 3 |
| Gabriel | Fame | link | ✓ | X | ✓ | X | ✓ | 3 |
| Kvadrat | Steelcut Trio 3 | link | ✓ | X | ✓ | X | ✓ | 5 |

✓ - fabric suitable for the product
 X - fabric not suitable for the product
 blank window - fabric requires testing

Fabric suitability

Standard collection of the carefully selected fabrics suitable for the HOWE products. They were all thoroughly tested, therefore we can guarantee these textiles meet our highest standards. Please check here which fabrics are dedicated to each of our product. If you're looking for a solution that reaches beyond standard options, please contact HOWE Customer Service.



| Supplier | Fabric's name | Composition | Marrindale | Flammability CAL 117 | Added flame retardant | Flammability M | Washable | Cleanable | Ecolabel | Oeko-TEX |
|----------|-----------------|--|------------|----------------------|-----------------------|----------------|----------|-----------|----------|----------|
| Gabriel | Cura | 98% post-consumer recycled polyester, 2% polyester | 100000 | YES | NO | NO | 60-74°C | YES | ✓ | ✓ |
| Gabriel | Event | 100% polyester | 100000 | YES | NO | NO | 60°C | YES | ✓ | ✓ |
| Gabriel | Fighter | 100% recyclable polyester | 130 000 | YES | NO | NO | YES | only dry | NO | ✓ |
| Camira | Main Line Plus | 67% Wool, 20% Flame Retardant Viscose, 13% Viscose | ≥50,000 | NO | YES | NO | YES | YES | NO | ✓ |
| Camira | Oceanic | 100% post-consumer recycled polyester | ≥100,000 | YES | NO | NO | 60°C | YES | ✓ | ✓ |
| Camira | Rivet | 100% post-consumer recycled polyester | ≥80,000 | YES | NO | NO | 60°C | YES | ✓ | NO |
| Gabriel | Step | 100% Trevira cs | 100 000 | YES | YES | M1 | 60-74°C | YES | ✓ | ✓ |
| Gabriel | Step Melange | 100% Trevira cs | 100 000 | YES | YES | M1 | 60-74°C | YES | ✓ | ✓ |
| Camira | Main Line Flax | 70% Virgin Wool, 30% Flax | ≥50,000 | YES | NO | NO | NO | YES | ✓ | NO |
| Gabriel | Crisp | 93% wool, 7% polyamide | 200 000 | YES | NO | M1 | NO | YES | ✓ | ✓ |
| Gabriel | Fame | 95% wool, 5% polyamide | 200 000 | YES | NO | NO | NO | only dry | ✓ | ✓ |
| Kvadrat | Steelcut Trio 3 | 90% New wool, 10% Nylon | 100 000 | YES | NO | NO | NO | only dry | ✓ | NO |

Moveo modesty panel

By Justus Kolberg & Erik Simonsen

Easy to move thanks to a light frame, Moveo is even more flexible than your calendar. Optimum mobility is ensured by the perfectly designed wheels.

- 10 year warranty
- FSC certified



| | Laminate | Linoleum | Veneer |
|----------------------------|----------|----------|--------|
| MODESTY PANEL | L42 ● | FL200 ● | V1 ● |
| | L43 ● | | V2 ● |
| | L50 ● | | V3 ● |
| | L55 ● | | V5 ● |
| | L310 ● | | V12 ● |
| | L420 ● | | V13 ● |
| | L110 ● | | V15 ● |
| | L600 ● | | |
| | L500 ● | | |
| | L210 ● | | |
| | SEK | SEK | SEK |
| Beam length 975 mm (GCGC) | 3185 | 4388 | 4501 |
| Beam length 1175 mm (GDGD) | 3468 | 4784 | 4897 |
| Beam length 1275 mm (GEGE) | 3751 | 5166 | 5308 |
| Beam length 1375 mm (GFGF) | 3751 | 5166 | 5308 |
| Beam length 1575 mm (GGGG) | 3751 | 5166 | 5308 |
| Beam length 1775 mm (GHGH) | 4034 | 5563 | 5704 |

Price list 2023 - SEK excl. V.A.T. - Version 1.2

Simpla

By John Bollen

The unique folding system makes Simpla radically different. In addition to a minimalist and elegant silhouette, the two-piece table is flexible and space-saving.

- Lift off top
- Unique flat folding frame
- PEFC certified
- FSC certified
- Up to 8 stacked tables on a transporter
- 5 year warranty



| | | Laminate (SG2) | Linoleum (SG4) | Veneer (SG3) | Stained Veneer (SG3) | |
|--|-------------------|--|-------------------|---|----------------------------|---------|
| <p>Melamine, Laminate and Linoleum are standard with matching ABS edge. Veneer is standard with matching hardwood edge. Table top thickness is 18mm Standard frame with glides - optional to get glides and castors. Linking is incl. 2 brackets</p> <p> B1 B7 B9 B10 B30 </p> | | L42 ● L43 ● L50 ● L55 ● L310 ● L420 ● L110 ● L600 ● L500 ● L210 ● | FL200 ● | V1 ● V2 ● V3 ● V5 ● V12 ● V13 ● V15 ● | LW17 ● LW25 ● LW30 ● | Linking |
| | | SEK | SEK | SEK | SEK | SEK |
| Rectangular | 1200x600mm (AAAA) | 13167 | 15100 | 16428 | 19301 | + 345 |
| Rectangular | 1400x700mm (ADAD) | 13825 | 15854 | 17248 | 20121 | |
| Rectangular | 1500x750mm (AEAE) | 14216 | 16303 | 17737 | 20610 | |
| Rectangular | 1600x795mm (SGSG) | N/A | N/A | N/A | N/A | |
| Rectangular | 1600x800mm (AFAF) | 14764 | 16931 | 18420 | 21293 | |
| Rectangular | 1800x900mm (AIAI) | 15720 | 18027 | 19612 | 22485 | |
| | | | | | | |
| Square | 750x750mm (BZBZ) | 12713 | 14579 | 15861 | 18734 | + 345 |
| | | | | | | |
| Half-round | 1400x700mm (BBBB) | 14905 | 17093 | 18596 | 21469 | + 345 |
| Half-round | 1500x750mm (BCBC) | 15234 | 17470 | 19007 | 21880 | |
| Half-round | 1600x800mm (BDDB) | 15547 | 17829 | 19397 | 22270 | |

Price list 2023 - SEK excl. V.A.T. - Version 1.1

2 glides and 2 castors +115 SEK

Simpla

By John Bollen

The unique folding system makes Simpla radically different. In addition to a minimalist and elegant silhouette, the two-piece table is flexible and space-saving.

- Lift off top
- Unique flat folding frame
- PEFC certified
- FSC certified
- 5 year warranty

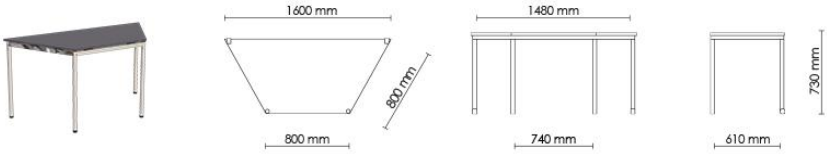
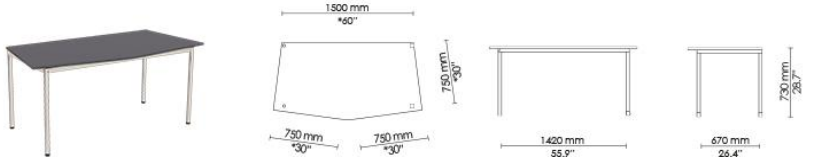

| | | Laminate (SG2) | Linoleum (SG4) | Veneer (SG3) | Stained Veneer (SG3) |
|---|-------------------|--|-------------------|---|----------------------------|
| Melamine, Laminate and Linoleum are standard with matching ABS edge. Veneer is standard with matching hardwood edge. Table top thickness is 18mm Standard frame with glides - optional to get glides and castors. Linking is incl. 2 brackets  | | L42 ● L43 ● L50 ● L55 ● L310 ● L420 ● L110 ● L600 ● L500 ● L210 ● | FL200 ● | V1 ● V2 ● V3 ● V5 ● V12 ● V13 ● V15 ● | LW17 ● LW25 ● LW30 ● |
| | | SEK | SEK | SEK | SEK |
| Trapezoid | 1500x750mm (BEBE) | 14436 | 16554 | 18010 | 20883 |
| Trapezoid | 1600x800mm (BFBF) | 14764 | 16931 | 18420 | 21293 |
|  | | | | | |
| V-Shaped | 1500x750mm (BQBQ) | 15594 | 17883 | 19456 | 22329 |
|  | | | | | |
| Round | Ø1050mm (BUBU) | 15125 | 17345 | 18870 | 21743 |
| Round | Ø1200mm (BVBV) | 16252 | 18637 | 20277 | 23150 |

Price list 2023 - SEK excl. V.A.T. - Version 1.1

2 glides and 2 castors +115 SEK

Simpla modesty panel

By John Bollen

The unique folding system makes Simpla radically different. In addition to a minimalist and elegant silhouette, the two-piece table is flexible and space-saving.



| Modesty panel | | |
|---|-------------------|-------|
| Simpla modesty panel in perforated steel, 250 mm high, with integrated cable tray and hooks to hang it on the Simpla frame. | | Steel |
| Simpla modesty panel in acrylic, 4 mm thick and 250 mm high, made of greenish acrylic plastic, mounted on the hooks. | | SEK |
| Rectangular | 1200 mm (DEDEGHY) | 3369 |
| Rectangular | 1400 mm (DGDGGHY) | 3369 |
| Rectangular | 1500 mm (DHDHGHY) | 3935 |
| Rectangular | 1600 mm (DIDIGHY) | 3935 |
| Rectangular | 1800 mm (DKDKGHY) | 3935 |

Price list 2023 - SEK excl. V.A.T. - Version 1.2

Tempest flip top

By KOMPLOT Design

Detail is everything. It is why the Tempest flips, rolls and unfolds possibilities like no other table system in the world.

- 10 year warranty
- World's leading flip-top table system
- Nesting depth of 130 mm
- 6 tables can be stacked on table transporter
- Elegant elliptical leg-design
- GreenTag^{Cert™}
- FSC certified
- ISO 14025 EPD
- **Quick ship - LINK**

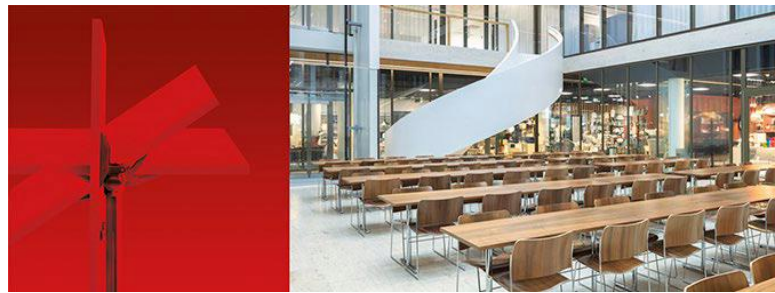

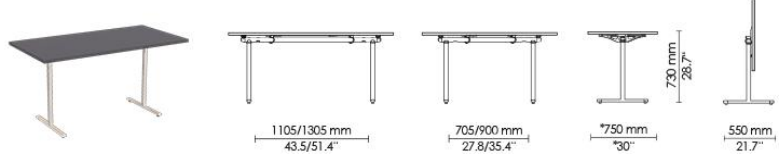
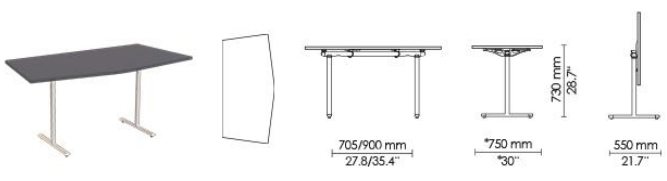
| | Laminate (TP2) | Linoleum (TP4) | Veneer (TP3) | Stained veneer (TP3) | | |
|--|---|-------------------|--|-----------------------------|----------------|-------|
| Melamine, laminate and linoleum are with matching ABS edge. Veneer is with matching hardwood edge. Other RAL colours available - ASK HOWE  B1 B6 B7 B9 B10 B30 Table top thickness: Melamine is 25mm. Laminate, linoleum and veneer is 27mm. Standard frame with glides and castors | L42 L43 L50 L55 L310 L420 L110 L600 L500 L210 SEK | FL200 SEK | V1 V2 V3 V5 V12 V13 V15 SEK | LW17 LW25 LW30 SEK | Linking SEK | |
|  | | | | | | |
| Rectangular | 1200x600mm (02AA) | 15162 | 17183 | 18954 | 21762 | +1724 |
| Rectangular | 1200x750mm (02AB) | 15697 | 17789 | 19622 | 22430 | |
| Rectangular | 1200x800mm (02AC) | 15778 | 17881 | 19723 | 22531 | |
| Rectangular | 1400x700mm (02AD) | 15875 | 17991 | 19845 | 22653 | |
| Rectangular | 1500x750mm (02AE) | 16409 | 18597 | 20513 | 23321 | |
| Rectangular | 1600x795mm (02SG) | N/A | N/A | N/A | N/A | |
| Rectangular | 1600x800mm (02AF) | 16766 | 19000 | 20959 | 23767 | |
| Rectangular | 1800x750mm (03AG) | 17122 | 19404 | 21404 | 24212 | |
| Rectangular | 1800x795mm (03TA) | N/A | N/A | N/A | N/A | |
| Rectangular | 1800x800mm (03AH) | 17478 | 19808 | 21850 | 24658 | |
| Rectangular | 1800x900mm (03AI) | 17932 | 20322 | 22417 | 25225 | |
| Rectangular | 2000x795mm (03OZ) | N/A | N/A | N/A | N/A | |
| Rectangular | 2000x1000mm (03AJ) | 19439 | 22030 | 24300 | 27108 | |
|  | | | | | | |
| V-Shape | 1500x750mm (02BQ) | 18726 | 21222 | 23409 | 26217 | N/A |

Price list 2023 - SEK excl. V.A.T. - Version 1.2

Tempest flip top

By KOMPLOT Design

Detail is everything. It is why the Tempest flips, rolls and unfolds possibilities like no other table system in the world.

- 10 year warranty
- World's leading flip-top table system
- Nesting depth of 130 mm
- 6 tables can be stacked on table transporter
- Elegant elliptical leg-design
- GreenTag^{CertTM}
- FSC certified
- ISO 14025 EPD



| | Laminate (TP2) | Linoleum (TP4) | Veneer (TP3) | Stained veneer (TP3) | |
|---|---|-------------------|--|-----------------------------|----------------|
| Melamine, laminate and linoleum are with matching ABS edge. Veneer is with matching hardwood edge. Other RAL colours available - ASK HOWE  Table top thickness: Melamine is 25mm. Laminate, linoleum and veneer is 27mm. Standard frame with glides and castors | L42 L43 L50 L55 L310 L420 L110 L600 L500 L210 SEK | FL200 SEK | V1 V2 V3 V5 V12 V13 V15 SEK | LW17 LW25 LW30 SEK | Linking SEK |
| | | | | | |
| Crescent | 1200x750mm (02AW) | 21139 | 23957 | 26426 | 29234 |
| Crescent | 1400x700mm (02AY) | 22225 | 25187 | 27783 | 30591 |
| Crescent | 1500x750mm (02AZ) | 23083 | 26160 | 28856 | 31664 |
| Crescent | 1600x800mm (03BA) | 24606 | 27886 | 30759 | 33567 |
| | | | | | |
| Trapezoid | 1500x750mm (01BE) | 16944 | 19202 | 21181 | 23989 |
| Trapezoid | 1600x800mm (01BF) | 17381 | 19698 | 21728 | 24536 |
| | | | | | |
| Half-round | 1400x700mm (01BB) | 16409 | 18597 | 20513 | 23321 |
| Half-round | 1500x750mm (01BC) | 16766 | 19000 | 20959 | 23767 |
| Half-round | 1600x800mm (02BD) | 17252 | 19551 | 21566 | 24374 |

Price list 2023 - SEK excl. V.A.T. - Version 1.2

Tempest fold

By KOMPLOT Design

Detail is everything. It is why the Tempest flips, rolls and unfolds possibilities like no other table system in the world.

- 10 year warranty
- Inverted elliptical T-leg style
- Legs: concealed wheel + adjustable glides
- 5 tables can be stacked on table transporter
- FSC certified

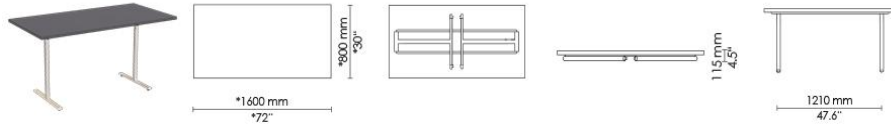
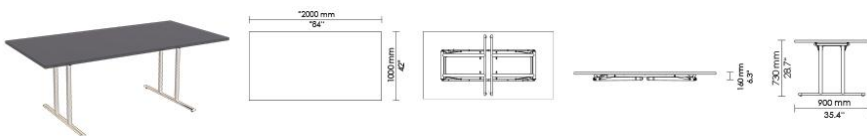

| | Laminate (TD2/TA2) | Linoleum (TD4/TA4) | Veneer (TD3/TA3) | Stained veneer (TD3/TA3) | | |
|--|--|-----------------------|--|-----------------------------|---------|-------|
| Melamine, laminate and linoleum are with matching ABS edge. Veneer is with matching hardwood edge. Other RAL colours available - ASK HOWE  Table top thickness: Melamine is 25mm. Laminate, linoleum and veneer is 27mm. | L42 L43 L50 L55 L310 L420 L110 L600 L500 L210 SEK | FL200 SEK | V1 V2 V3 V5 V12 V13 V15 SEK | LW17 LW25 LW30 SEK | Linking | |
| |  | | | | SEK | |
| Rectangular | 1200x600mm (04AA) | 18282 | 20719 | 22853 | 25987 | +1724 |
| Rectangular | 1200x750mm (04AB) | 18915 | 21436 | 23644 | 26778 | |
| Rectangular | 1200x800mm (04AC) | 19041 | 21580 | 23802 | 26936 | |
| Rectangular | 1400x700mm (04AD) | 19150 | 21703 | 23938 | 27072 | |
| Rectangular | 1500x750mm (05AE) | 19783 | 22420 | 24729 | 27863 | |
| Rectangular | 1600x795mm (05SG) | N/A | N/A | N/A | N/A | |
| Rectangular | 1600x800mm (05AF) | 20217 | 22912 | 25272 | 28406 | |
| Rectangular | 1800x750mm (05AG) | 20651 | 23404 | 25814 | N/A | |
| Rectangular | 1800x795mm (05TA) | N/A | N/A | N/A | N/A | |
| Rectangular | 1800x800mm (05AH) | 21085 | 23895 | 26357 | N/A | |
| Rectangular | 1800x900mm (05AI) | 21609 | 24490 | 27012 | 30146 | |
|  | | | | | | +1724 |
| Rectangular conf. | 2000x1000mm (05AJ) | 26262 | 29753 | 32827 | 38574 | |
| Rectangular conf. | 2400x1200mm (05AK) | 29030 | 32890 | 36287 | 42034 | |

Price list 2023 - SEK excl. V.A.T. - Version 1.2

Tempest fold

By KOMPLOT Design

Detail is everything. It is why the Tempest flips, rolls and unfolds possibilities like no other table system in the world.

- 10 year warranty
- Inverted elliptical T-leg style
- Legs: concealed wheel + adjustable glides
- 5 tables can be stacked on table transporter
- FSC certified

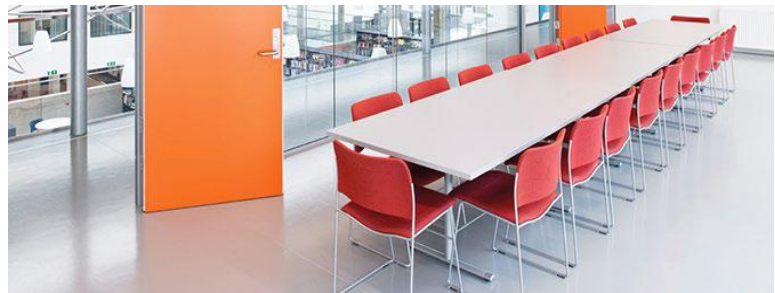

| | Laminate (TD2) | Linoleum (TD4) | Veneer (TD3) | Stained veneer (TD3) | | |
|--|---|-------------------|--|-----------------------------------|---------|-------|
| <p>Melamine, laminate and linoleum are with matching ABS edge. Veneer is with matching hardwood edge. Other RAL colours available - ASK HOWE</p> <p>B1 B6 B7 B9 B10 B30</p> <p>Table top thickness: Melamine is 25mm. Laminate, linoleum and veneer is 27mm.</p> | L42 ● L43 ● L50 ● L55 ● L310 ● L420 ● L110 ● L600 ● L500 ● L210 ● SEK | FL200 ● SEK | V1 ● V2 ● V3 ● V5 ● V12 ● V13 ● V15 ● SEK | LW17 ● LW25 ● LW30 ● SEK | Linking | |
| | | | | | | |
| Crescent | 1200x750mm (04AW) | 25479 | 28875 | 31849 | 34983 | +1724 |
| Crescent | 1400x700mm (04AY) | 26781 | 30351 | 33477 | 36611 | |
| Crescent | 1500x750mm (05AZ) | 27830 | 31539 | 34788 | 37922 | |
| Crescent | 1600x800mm (05BA) | 29674 | 33630 | 37094 | 40228 | |
| Trapezoid | 1500x750mm (05BE) | 20434 | 23158 | 25543 | 28677 | N/A |
| Trapezoid | 1600x800mm (05BF) | 21067 | 23875 | 26334 | 29468 | |

Price list 2023 - SEK excl. V.A.T. - Version 1.2

Tempest fold

By KOMPLOT Design

Detail is everything. It is why the Tempest flips, rolls and unfolds possibilities like no other table system in the world.

- 10 year warranty
- Inverted elliptical T-leg style
- Legs: concealed wheel + adjustable glides
- 5 tables can be stacked on table transporter
- FSC certified



| | Laminate (TD2) | Linoleum (TD4) | Veneer (TD3) | Stained veneer (TD3) | | | |
|---|---|-------------------|--|-----------------------------|----------------|-------|------|
| <p>Melamine, laminate and linoleum are with matching ABS edge. Veneer is with matching hardwood edge. Other RAL colours available - ASK HOWE</p> <p>Table top thickness: Melamine is 25mm. Laminate, linoleum and veneer is 27mm.</p> | L42 L43 L50 L55 L310 L420 L110 L600 L500 L210 SEK | FL200 SEK | V1 V2 V3 V5 V12 V13 V15 SEK | LW17 LW25 LW30 SEK | Linking SEK | | |
| | V-Shape | 1500x750mm (05BQ) | 22586 | 25596 | 28233 | 31367 | N/A |
| | Half-round | 1400x700mm (04BB) | 19783 | 22420 | 24729 | 27863 | +862 |
| Half-round | 1500x750mm (05BC) | 20217 | 22912 | 25272 | 28406 | | |
| Half-round | 1600x800mm (05BD) | 20795 | 23568 | 25995 | 29129 | | |

Price list 2023 - SEK excl. V.A.T. - Version 1.2

Tempest fix

By KOMPLOT Design

Detail is everything. It is why the Tempest flips, rolls and unfolds possibilities like no other table system in the world.

- 10 year warranty
- Inverted elliptical T-leg style
- Legs: concealed wheel + adjustable glides
- GreenTag^{CertTM}
- FSC certified
- ISO 14025 EPD



| | Laminate (T12) | Linoleum (T14) | Veneer (T13) | Stained veneer (T13) | | |
|---|---|-------------------|--|-----------------------------|----------------|-------|
| <p>Melamine, laminate and linoleum are with matching ABS edge. Veneer is with matching hardwood edge. Other RAL colours available - ASK HOWE</p> <p>Table top thickness: Melamine is 25mm. Laminate, linoleum and veneer is 27mm.</p> | L42 L43 L50 L55 L310 L420 L110 L600 L500 L210 SEK | FL200 SEK | V1 V2 V3 V5 V12 V13 V15 SEK | LW17 LW25 LW30 SEK | Linking SEK | |
| | | | | | | |
| Rectangular | 1200x600mm (06AA) | 13542 | 15348 | 16929 | 19737 | +1724 |
| Rectangular | 1200x750mm (06AB) | 14028 | 15899 | 17536 | 20344 | |
| Rectangular | 1200x800mm (06AC) | 14093 | 15972 | 17617 | 20425 | |
| Rectangular | 1400x700mm (06AD) | 14190 | 16082 | 17739 | 20547 | |
| Rectangular | 1500x750mm (06AE) | 14676 | 16633 | 18346 | 21154 | |
| Rectangular | 1600x795mm (06SG) | N/A | N/A | N/A | N/A | |
| Rectangular | 1600x800mm (06AF) | 14984 | 16982 | 18731 | 21539 | |
| Rectangular | 1800x750mm (06AG) | 15291 | 17331 | 19116 | 21924 | |
| Rectangular | 1800x795mm (06TA) | N/A | N/A | N/A | N/A | |
| Rectangular | 1800x800mm (06AH) | 15615 | 17698 | 19521 | 22329 | |
| Rectangular | 1800x900mm (06AI) | 16020 | 18157 | 20027 | 22835 | |
| | | | | | | |
| Half-round | 1400x700mm (06BB) | 14676 | 16633 | 18346 | 21154 | +862 |
| Half-round | 1500x750mm (06BC) | 14984 | 16982 | 18731 | 21539 | |
| Half-round | 1600x800mm (06BD) | 15405 | 17459 | 19258 | 22066 | |

Price list 2023 - SEK excl. V.A.T. - Version 1.2

Tempest fix

By KOMPLOT Design

Detail is everything. It is why the Tempest flips, rolls and unfolds possibilities like no other table system in the world.

- 10 year warranty
- Inverted elliptical T-leg style
- Legs: concealed wheel + adjustable glides
- GreenTag^{Cert™}
- FSC certified
- ISO 14025 EPD



| | Laminate (T12) | Linoleum (T14) | Veneer (T13) | Stained veneer (T13) | | |
|---|---|-------------------|--|-----------------------------|---------|-------|
| <p>Melamine, laminate and linoleum are with matching ABS edge. Veneer is with matching hardwood edge. Other RAL colours available - ASK HOWE</p> <p>Table top thickness: Melamine is 25mm. Laminate, linoleum and veneer is 27mm.</p> | L42 L43 L50 L55 L310 L420 L110 L600 L500 L210 SEK | FL200 SEK | V1 V2 V3 V5 V12 V13 V15 SEK | LW17 LW25 LW30 SEK | Linking | |
| | | | | | | |
| Crescent | 1200x750mm (06AW) | 18888 | 21406 | 23611 | 26419 | +1724 |
| Crescent | 1400x700mm (06AY) | 19843 | 22489 | 24806 | 27614 | |
| Crescent | 1500x750mm (06AZ) | 20605 | 23352 | 25758 | 28566 | |
| Crescent | 1600x800mm (06BA) | 21982 | 24913 | 27479 | 30287 | |
| | | | | | | |
| Trapezoid | 1500x750mm (06BE) | 15146 | 17165 | 18934 | 21742 | N/A |
| Trapezoid | 1600x800mm (06BF) | 15534 | 17606 | 19420 | 22228 | |
| | | | | | | |
| V-Shape | 1500x750mm (06BQ) | 16717 | 18946 | 20898 | 23706 | N/A |

Price list 2023 - SEK excl. V.A.T. - Version 1.2

Tempest modesty panel

By KOMPLOT Design

Detail is everything. It is why the Tempest flips, rolls and unfolds possibilities like no other table system in the world.

- 10 year warranty
- FSC certified



| | | Laminate | Linoleum | Veneer |
|--|----------------|--|----------|---|
| | | 9 mm | 9 mm | 9 mm |
| MODESTY PANEL - Hook | | L42 ● L43 ● L50 ● L55 ● L310 ● L420 ● L110 ● L600 ● L500 ● L210 ● | FL200 ● | V1 ● V2 ● V3 ● V5 ● V12 ● V13 ● V15 ● |
| Rectangular modesty panel, on hooks, panel height 250 mm. Suite for rectangular flip-top or fixed tables. *standard colour, same as tabletop | | SEK | SEK | SEK |
| Rectangular | 700 mm (FMFM) | 2902 | 3991 | 4105 |
| Rectangular | 750 mm (FNFN) | 2902 | 3991 | 4105 |
| Rectangular | 800 mm (DADA) | 2902 | 3991 | 4105 |
| Rectangular | 1200 mm (DEDE) | 3185 | 4387 | 4501 |
| Rectangular | 1400 mm (DGDG) | 3468 | 4769 | 4912 |
| Rectangular | 1500 mm (DHDH) | 3751 | 5166 | 5308 |
| Rectangular | 1600 mm (DIDI) | 3751 | 5166 | 5308 |
| Rectangular | 1800 mm (DKDK) | 3751 | 5166 | 5308 |
| MODESTY PANEL - Demountable | | Laminate | Linoleum | Veneer |
| | | 20 mm | 20 mm | 20 mm |
| Rectangular modesty panel, on hooks, panel height 250 mm. Suite for rectangular flip-top or fixed tables. *standard colour, same as tabletop | | | | |
| Rectangular | 700 mm (FMFM) | 3142 | 3935 | 4006 |
| Rectangular | 750 mm (FNFN) | 3142 | 3935 | 4006 |
| Rectangular | 800 mm (DADA) | 3142 | 3935 | 4006 |
| Rectangular | 1200 mm (DEDE) | 3453 | 4331 | 4402 |
| Rectangular | 1400 mm (DGDG) | 3567 | 4473 | 4558 |
| Rectangular | 1500 mm (DHDH) | 3680 | 4614 | 4700 |
| Rectangular | 1600 mm (DIDI) | 3680 | 4614 | 4700 |
| Rectangular | 1800 mm (DKDK) | 3807 | 4756 | 4841 |

Price list 2023 - SEK excl. V.A.T. - Version 1.2

Tempest modesty panel

By KOMPLOT Design

Detail is everything. It is why the Tempest flips, rolls and unfolds possibilities like no other table system in the world.

- 10 year warranty
- FSC certified

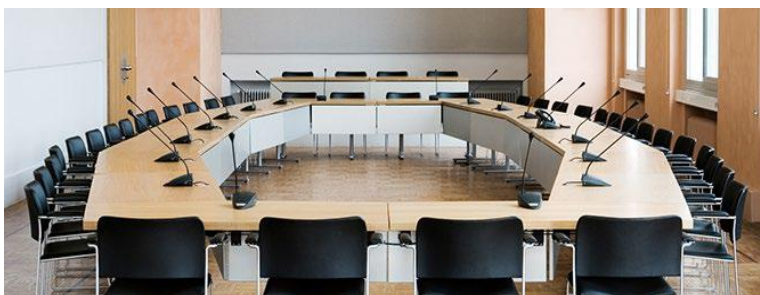

Acrylic
4 mm

| MODESTY PANEL | | |
|---|----------------|------|
| Rectangular modesty panel, on hooks, panel height 250 mm. Suitabe for rectangular flip-top or fixed tables. | | |
| | | SEK |
| Rectangular | 700 mm (FMFM) | 2477 |
| Rectangular | 750 mm (FNFN) | 2477 |
| Rectangular | 800 mm (DADA) | 2477 |
| Rectangular | 1200 mm (DEDE) | 2930 |
| Rectangular | 1400 mm (DGDG) | 3454 |
| Rectangular | 1500 mm (DHDH) | 3454 |
| Rectangular | 1600 mm (DIDI) | 3454 |
| Rectangular | 1800 mm (DKDK) | 3454 |

Price list 2023 - SEK excl. V.A.T. - Version 1.1



















Tutor

By John Bollen

This stackable table pays tribute to the iconic 40/4 chair, and in the process, becomes an icon itself.

- Up to 30 tables can be stacked on dolly
- Up to 10 tables can be stacked on floor
- Use in education and training establishments
- 5 year warranty
- **Quick ship - LINK**



| | | | | |
|--|---|--|--|--|
| | | Compact Laminate (OFA) | | |
| Table top thickness is 6 mm bendable compact laminate. Other compact laminate colours: ask HOWE Other RAL colours - ask HOWE | | F300  F200  | With felt glides (F) | |
|  B1 B7 B9 B10 B30 | | SEK | SEK | |
|  600 mm 23.6" |  670 mm 26.4" |  665 mm 26.2" |  720 mm 28.3" |  800 mm 31.5" |
| Single table 600 mm (AA) | | 5215 | 5337 | |
|  1200 mm 47.2" |  1270 mm 50" |  665 mm 26.2" |  720 mm 28.3" |  800 mm 31.5" |
| Double table 1200 mm (BA) *Suitable for side chairs | | 9579 | 9701 | |
|  1390 mm 54.7" |  1460 mm 57.5" |  665 mm 26.2" |  720 mm 28.3" |  800 mm 31.5" |
| *Double table 1390 mm (CA) *Suitable for armchairs and swivel chairs | | 11578 | 11700 | |

Price list 2023 - SEK excl. V.A.T. - Version 1.1

Net price: RAL K5 colours for frame - see notes

Usu

By HOWE in-house design team

Usu is a study of simplicity in both form and function. The intuitive folding mechanism and transporter, with room for ten rectangular and square tables, make Usu easy to move.

- 5 year warranty
- Up to 10 rectangular and square tables stacked on a transporter
- Stylish round 4-leg design
- FSC certified
- Design for disassembly



Laminate

(UF2)

Laminate is standard with matching ABS edge.
Table top thickness is 18mm.
Standard frame with 2 glides and 2 castors.
Linking is incl. 2 brackets

| | |
|------|--|
| L310 | |
| L420 | |
| L110 | |
| L600 | |
| L500 | |
| L210 | |



*Due to the technological process, the black may slightly differ in terms of its gloss.

SEK

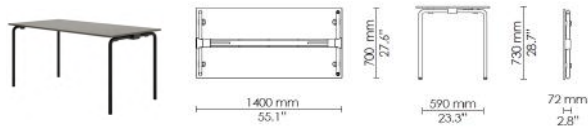

| | | |
|-------------|-------------------|-------|
| Rectangular | 1200x600mm (AAAA) | 8595 |
| Rectangular | 1400x700mm (ADAD) | 9465 |
| Rectangular | 1600x800mm (AFAF) | 9792 |
| Square | 800x800mm (CACA) | 8595 |
| Round | Ø1200mm (BVBV) | 11097 |

Price list 2023 - SEK excl. V.A.T. - Version 1.1

| | | |
|----------------|------|-----|
| Linking | +87 | SEK |
| ** Chrome base | +653 | SEK |







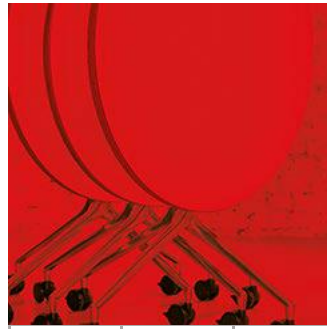

AS400

By Andreas Störiko

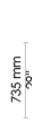
The AS series is highly inspired and highly functional. Combining elegance and utility with true mobility, the family of nesting chairs and tables leaves room for all imaginable purposes.

- 10 year warranty
- Café height tables
- Unbelievably easy to manoeuvre
- Intuitive flip-top mechanism
- Special handle allows to lift the AS tables
- Smart elastic cord firmly joins concave tables
- Rubber bumper protects tables from scratches
- An infinite number of tables can then be nested together

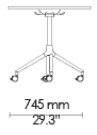

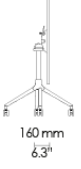
| | | Laminate (AB2) | Linoleum (AB4) | Veneer (AB3) |
|---|--|--|--|---|
| Laminates are with matching ABS edge. Linoleum and veneer are with non-matching, transparent lacquer. Other RAL colours available - ASK HOWE Standard base colours: B6 B7 B31 B51 | L42 L43 L310 L420 L110 L600 L500 L210 | ● ● ● ● ● ● ● ● | FL200 ● | V2 ● V3 ● |
| | | SEK | SEK | SEK |
|  |  640 mm 25.2" |  745 mm 29.3" |  735 mm 29" |  160 mm 6.3" |
| Square | 640 x 640 mm (tiny pre-drills in the top; possibility to order linking later) | 9143 | 12484 | 13559 |
| Square with link | 640 x 640 mm | 9709 | 13050 | 14125 |
|  |  830 mm 32.7" |  745 mm 29.3" |  735 mm 29" |  160 mm 6.3" |
| Round | Ø830mm | 9143 | 12484 | 13559 |
| Concave with link | Ø830mm | 9899 | 13299 | 14433 |

Price list 2023 - SEK excl. V.A.T. - Version 1.1

| | |
|---|-----------|
| Transparent lacquer on plywood core for laminate or nano-laminate | +2123 SEK |
| Soft lane castors | +127 SEK |

AS500

By Andreas Störko

The AS series is highly inspired and highly functional. Combining elegance and utility with true mobility, the family of nesting chairs and tables leaves room for all imaginable purposes.

- 10 year warranty
- Bar height tables
- Unbelievably easy to manoeuvre
- Intuitive flip-top mechanism
- Special handle allows to lift the AS tables
- Smart elastic cord firmly joins concave tables
- Rubber bumper protects tables from scratches
- An infinite number of tables can then be nested together



| | Laminate (AD2) | Linoleum (AD4) | Veneer (AD3) | |
|--|--|----------------|--------------|-------|
| Laminate are with matching ABS edge. Linoleum and veneer are with non-matching, transparent lacquer. Other RAL colours available - ASK HOWE Standard base colours: B6 B7 B31 B51 | L42 L43 L310 L420 L110 L600 L500 L210 | FL200 | V2 V3 | |
| | SEK | SEK | SEK | |
| | | | | |
| Square (tiny pre-drills in the top; possibility to order linking later) | 600 x 600 mm | 9795 | 13234 | 14366 |
| Square with link | 600 x 600 mm | 10361 | 13800 | 14932 |
| | | | | |
| Round | Ø700 mm | 9795 | 13234 | 14366 |

Price list 2023 - SEK excl. V.A.T. - Version 1.1

| | |
|---|-----------|
| Transparent lacquer on plywood core for laminate or nano-laminate | +2123 SEK |
|---|-----------|

| | |
|-------------------|----------|
| Soft lane castors | +127 SEK |
|-------------------|----------|

Accessories

Tables' transporters

HOWE combines simplicity and functionality with a focus on timeless originality. In every moving detail. This is why our furniture stacks, folds, rolls and creates flexible solutions like no other designs in the world.



| | | | |
|--|---------|-----------|--|
| Tempest Flip-top | | Per Piece | |
| Capacity up to 5 tables standing up (flipped position). Dimensions: 960 mm high, 2000 mm long and 915 mm wide. MDF platform, metal powdercoated in B10 Howe grey. | | | |
| | SEK | | |
| Transporter | Tempest | 26355 | |
| Tempest Fold | | Per Piece | |
| Capacity: up to 10 pcs Stacks on table edge, secured with straps. Top against top - base against base. Colour B10 Howe grey. Dimensions: 1131 mm high x 2010 mm long x 562 mm wide Suitable for length 1200-1800 mm and width 600-900 mm. | | | |
| | SEK | | |
| A-kit big | Tempest | 13056 | |
| Only USU | | Per Piece | |
| Capacity: up to 10 pcs Stacks on table edge, secured with strap. Colour: black Height: 1125 mm, length: 1155 mm, depth: 450 mm. The dimensions are without tables on the transporter. Suitable for rectangular and square tables 800-1800 mm long and 500-900 mm wide | | | |
| | SEK | | |
| Usu dolly | Usu | 11968 | |
| Tempest Fold | | Per Piece | |
| Capacity w/rectangular tables: up to 5 pcs Capacity w/ all other shapes: up to 5 pcs Stacks on table edge, secured with straps. Top against top - base against base. Colour B10 Howe grey. Dimensions: 1255 mm high x 2010 mm long x 775 mm wide Suitable for length 2000-2400 mm and width 1000-1200 mm (when rectangular). | | | |
| | SEK | | |
| L-kit | Tempest | 17466 | |



Price list 2023 - SEK excl. V.A.T. - Version 1.1

Accessories

Tables' transporters cont.

HOWE combines simplicity and functionality with a focus on timeless originality. In every moving detail. This is why our furniture stacks, folds, rolls and creates flexible solutions like no other designs in the world.



| | | | | |
|---|--------|-----------|---|-------|
| Simpla | | Per Piece |  | |
| Capacity up to 8 tables. Colour B10 Howe grey. Dimensions: height 1895, depth 840, adjustable width Suitable for rectangular tables: length 1000-1800 and width up to 900 mm. For other shapes and sizes, please ask HOWE. | | | | SEK |
| Transporter | Simpla | | | 22052 |
| Tutor single size | | Per Piece |  | |
| Capacity up to 30 tables. Suitable for single size Tutor tables. Colour B10 Howe grey. | | | | SEK |
| Transporter | Tutor | | | 13234 |
| Tutor double size | | Per Piece |  | |
| Capacity up to 30 tables. Suitable for double size Tutor tables. Colour B10 Howe grey. | | | | SEK |
| Transporter | Tutor | | | 17777 |

Price list 2023 - SEK excl. V.A.T. - Version 1.1

Accessories

AS tables privacy screens

Aesthetically pleasing, the innovative felt privacy screen creates enclosure to spaces during work, education, and meeting areas. It gives flexibility to produce boundaries, as well as visual privacy.



| | | | |
|---|----------|-----------|--|
| Privacy screen | | Per Piece | |
| Privacy screen for AS round and round concave tables. 1188x350 mm; 12 mm thick; light grey felt | | | |
| Screen | 66091001 | SEK | |
| | | 4896 | |

Price list 2023 - SEK excl. V.A.T. - Version 1.1

Notes for tables

Price list 2023 - SEK excl. V.A.T. - Version 1.1

General

HOWE standard delivery times in EU are usually: Chairs 4-6 weeks, Tables 5-7 weeks.

In case of large quantities and/or customized products delivery time will be determined on a case-by-case basis.

The following products may have a slightly longer lead time so please ask HOWE:

- Simpla: Trapezoidal
- Tutor: 1390 mm double table (for armchairs and swivel chairs), F200 black tabletop

In case of using any electrification, accessories, or making configurations, the lead time starts being counted once technical drawings are approved by the customer.

Moveo

Moveo linking for rectangular and V-shaped tables includes 4 brackets and 4 fittings. Moveo linking for half-round and half-boat tables includes 2 brackets and 2 fittings. This type of linking is available for tables with straight edges only. Another linking type is available for tables with chamfered edges. Here you also get 4 brackets and 4 fittings for rectangular and V-shape tables as well as 2 brackets and 2 fitting for half-round and half-boat tables.

All RAL colours from RAL K5 colour card available. For quantities < 20 tables the colour fee is 2620 SEK per RAL colour. For quantities ≥ 20 tables there is no fee. Visual impression of particular RAL may differ on various surfaces. Preparing product's sample(s) is compulsory. Lead time to be confirmed by HOWE CS.

Simpla

Please note that Simpla linking does not need any pre-drills and may be ordered at any time as a separate accessory.

Please note that Modesty panels for Simpla are just hanged on the frame and may be ordered at any time as a separate accessory.

All RAL colours from RAL K5 colour card available. For quantities < 50 tables the colour fee is 2620 SEK per RAL colour. For quantities ≥ 50 tables there is no fee. Visual impression of particular RAL may differ on various surfaces. Preparing product's sample(s) is compulsory. Lead time to be confirmed by HOWE CS.

Tempest

Tempest linking for rectangular, crescent, and square tables includes 4 brackets and 4 fittings. Tempest linking for half-round tables includes 2 brackets and 2 fittings. This type of linking is available for tables with straight edges only. Another linking type is available for tables with chamfered edges. Please contact HOWE for options.

All RAL colours from RAL K5 colour card available. For quantities < 20 tables the colour fee is 2620 SEK per RAL colour. For quantities ≥ 20 tables there is no fee. Visual impression of particular RAL may differ on various surfaces. Preparing product's sample(s) is compulsory. Lead time to be confirmed by HOWE CS.

Usu

Please note that Usu linking may be ordered at any time as a separate accessory.





















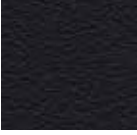











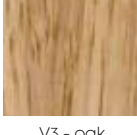
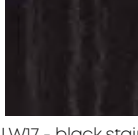
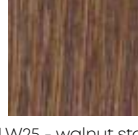
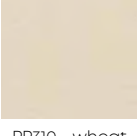

Tutor

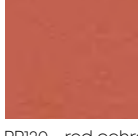
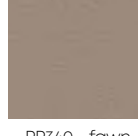
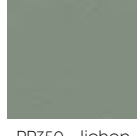
All RAL colours from RAL K5 colour card available. For quantities < 50 tables the colour fee is 2620 SEK per RAL colour. For quantities ≥ 50 tables there is no fee. Visual impression of particular RAL may differ on various surfaces. Preparing product's sample(s) is compulsory. Lead time to be confirmed by HOWE CS.

Tutor

All RAL colours from RAL K5 colour card available. For quantities < 50 tables the colour fee is 2620 SEK per RAL colour. For quantities \geq 50 tables there is no fee. Visual impression of particular RAL may differ on various surfaces. Preparing product's sample(s) is compulsory. Lead time to be confirmed by HOWE CS.

Finish selection - Chairs

| | | | | | | | |
|---|---|---|---|---|---|---|---|
| 40/4 Seats / backs Natural wood veneers |  |  |  |  |  |  |  |
| | V1 - maple | V2 - beech | V3 - oak | V5 - cherry | V12 - ash EMEA ONLY | V13 - birch EMEA ONLY | V15 - walnut |
| 40/4 Seats / backs Stains |  |  |  | All RAL colours available based upon customer sample | | | |
| | LW17 - black | LW30 - white | Any RAL | | | | |
| 40/4 Seats / backs Polyamide |  |  |  |  |  | | |
| | PA200 - black | PA100 - Howe grey | PA300 - coconut | PA110 - Ayers Rock red | PA260 - marine blue | | |
| |  |  |  |  |  | | |
| | PA360 - olive green | PA320 - mandarin | PA250 - blue eyes | PA370 - mint turquoise | PA380 - aubergine | | |
| 40/4 Seats / backs Metal |  |  |  |  | All RAL colours available based upon customer sample | | |
| | ME200 - black | ME300 - white | ME110 - red EMEA ONLY | Any RAL | | | |
| 40/4 WOOD FRAME Seats / backs Natural wood veneers / stains |  |  |  |  | | | |
| | V2 - beech | V3 - oak | LW17 - black stain | LW25 - walnut stain | | | |
| SixE Shells Polypropolyne |  |  |  |  |  | | |
| | PP310 - wheat | PP270 - ocean | PP120 - red ochre | PP340 - fawn | PP350 - lichen | | |
| |  |  |  |  |  |  |  |
| | PP200 - black | PP100 - Howe grey | → HOWE GREY SHELL AVAILABLE AS 100% RECYCLED | PP300 - chalk | PP110 - Ayers Rock red | PP250 - blue eyes | PP360 - olive green |

MN1
Backs
Natural wood
veneers / stains



V3 - oak



LW17 - black stain

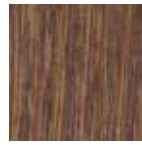

LW25 - walnut stain

THE TONGUE
Shells
Natural wood
veneers / stains



V3 - oak



V15 - walnut



LW17 - black stain

MUNKEGAARD CHAIR
Shells
Natural wood
veneers / stains



V3 - oak



V15 - walnut



LW17 - black stain

40/4
SIXE
Frames
Steel

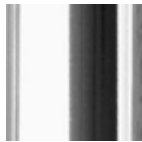

B1 - chrome



B6 - satin black



B7 - black



B9 - alu grey



B10 - Howe grey



B30 - white

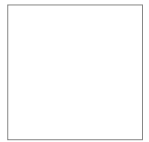

Any RAL

All RAL colours
available based
upon customer
sample

SIXE SWIVEL
SIXE LEARN
Base
Polyamide

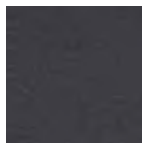

PA100 - Howe grey

SIXE SWIVEL
SIXE LEARN*
Swing arm*
Gas lift



B10 - Howe grey

MN1
Bases

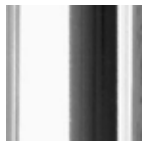

B1 - chrome



B7 - black



B51 - polished alu

THE TONGUE
MUNKEGAARD CHAIR
Frames
Steel



B1 - chrome



B7 - black



B30 - white

AS100
Bases / seat frames

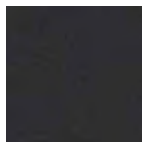

B6 - satin black



B7 - black



B51 - polished alu

CHAIRS



Finish selection - Tables EMEA

AS TABLES
MOVEO
SIMPLA
TEMPEST

Tops
Natural wood
veneers / Stains



V1 - maple



V2 - beech

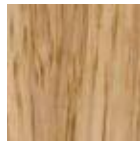

V3 - oak



V5 - cherry



V12 - ash



V13 - birch



V15 - walnut

AS tables standard:
V2 beech, V3 oak ONLY



LW17 - black stain



LW25 - walnut stain



LW30 - white stain



Any RAL

All RAL colours available
based upon customer sample

AS TABLES
MOVEO
SIMPLA
TEMPEST

Tops
Wood grain
laminates



L42 - beech



L43 - oak



L55 - walnut



L50 - grey oak

AS tables standard:
L42 beech, L43 oak ONLY

AS TABLES
MOVEO
SIMPLA
TEMPEST
USU

Tops
Coloured
laminates



L310 - white



L420 - grey



L110 - Howe grey



L210 - black



L500 - metal slate

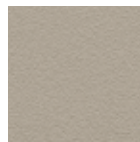

L600 - stone grey



Any coloured
laminates*

*Any coloured laminates
does not apply to Usu

AS TABLES
MOVEO
SIMPLA
TEMPEST

Tops
Coloured
nano laminates



NL350 - eggshell white

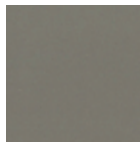

NL450 - warm grey

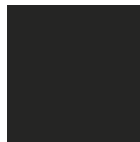

NL200 - black



TABLES

EMEA



MOVEO
SIMPLA
TEMPEST
USU
Tops
Melamines



M310 - white

TUTOR
Tops
Bendable
compact
laminates



F300 - white



F200 - black



Any bendable
compact laminate

AS TABLES
MOVEO
SIMPLA
TEMPEST
Tops
Linoleums

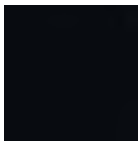

FL200 - black

SIMPLA
TUTOR
Bases
Steel



B1 - chrome



B7 - black



B9 - alu grey



B10 - Howe grey



B30 - white

TEMPEST
Bases
Steel



B1 - chrome

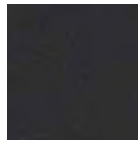

B6 - satin black



B7 - black



B9 - alu grey



B10 - Howe grey



B30 - white

USU
Bases
Steel



B1 - chrome

MOVEO
Bases
Aluminum



B6 - satin black

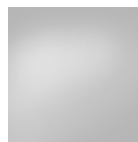

B51 - polished alu



B52 - anodized alu

AS TABLES
Bases



B6 - satin black



B7 - black



B31 satin white
- columns only

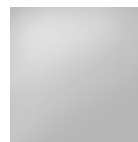

B51 - polished alu
- bases only



COLOUR REFERENCE ONLY
Variations in colours and structures may occur.

Subject to ongoing changes and adjustments.

JULY 2023

howe.com