

# **vitra.**

## **PRICE LIST 2023**

HOME COLLECTION & OFFICE SEATING

SE – EN

A digital price list with a visual product information tool for Sales and Retail.

Quick and easy access to up-to-date product information anytime and anywhere.

**Start using pCon.facts**



Prices valid from 1<sup>st</sup> January 2023

# SENAB

## Färgmarkeringar och/eller symboler för hållbara alternativ i prislistan:

### Mörkgrön markering eller symbol

Miljömärkt produkt – Möbler där hela den sammansatta varan har en typ 1 miljömärkning enligt ISO 14024 med Svanen, Möbelfakta, EU Ecolabel eller annan likvärdig märkning.

### Ljusgrön markering eller symbol

Hållbarhetsmärkt produkt eller beståndsdel – Möbler där hela eller delar av den sammansatta varan är hållbarhetsmärkt, exempelvis med FSC, EU Ecolabel eller OEKO-TEX®. Leverantören ska kunna ge mer detaljerad information om vilka delar eller variationer som är hållbarhetsmärka vid begäran.

### Orange markering eller symbol

Klimatberäknad produkt – Produkt med dokumenterad miljövarudeklaration (EPD) enligt ISO 14025.

### Lila markering eller symbol

Produkt med återvunnet eller förnybart material (enligt definitionerna i ISO 14021). Leverantören ska kunna ge information om andel (%) återvunnet och/eller förnybart (biobaserat) vid begäran. Märkning av återvinningsbart material utgår.

### Blå markering eller symbol

Demonterbar produkt – Produkt som är demonterbar till olika komponenter och beståndsdelar som i första hand möjliggör återbruk och i andra hand materialåtervinning när produkten nått sin fulla livslängd. Produkten ska vara designad för renovering, det vill säga att det ska vara enkelt att reparera och byta ut moduler, komponenter och beståndsdelar som slits över tid. Exempelvis ska ytskikt, som bordsskivor, textil och stoppning kunna tas isär, avlägsnas och ersättas med hjälp av vanligt förekommande manuella verktyg, ej specialverktyg. Enklare reparationer och utbytesarbeten ska kunna utföras av en lekman. Om det krävs fackmanakunskap för mer avancerade arbeten ska det framgå av anvisningarna som leverantören ska kunna ge vid begäran. Anvisningarna ska innehålla en sprängskiss, steg för steg beskrivning inklusive vilka verktyg som krävs samt hur möbelns ingående delar bör källsorteras.

## Areas of use

Some products are recommended for domestic use only. Such information is noted in the description of materials.

Special requirements and standards apply for furniture that will be subject to intensive usage in public spaces, such as educational institutions, fast food restaurants or event venues. Please ask our sales representatives about the suitability of the respective Vitra product for these kinds of applications before placing an order.

All products in the **Quick Ship** programme are identified in the price list by a lorry symbol. 

Office and conference chairs (swivel)

Chairs

Tables

Desks

Public waiting areas

Lounge chairs and armchairs

Sofas

Coffee and side tables

Stools and benches

Storage and partition elements

**Accessories**  
Living, dining, decorative objects, home office,  
clocks, lighting and publications

Quick Ship programme

General terms, conditions  
and information



# Alphabetical index by product

## Price list 2023

	.		431	Eames House Bird
			432	Eames House Whale
56	.03	Maarten Van Severen	200	Eames Plastic Armchair beam seating Charles & Ray Eames
7	.04	Maarten Van Severen	89	Eames Plastic Armchairs DAL, DAX Charles & Ray Eames
194	.04	beam seating Maarten Van Severen	86	Eames Plastic Armchairs DAR, DAW Charles & Ray Eames
58	.05	Maarten Van Severen	92	Eames Plastic Armchair LAR Charles & Ray Eames
	<b>A</b>		93, 227	Eames Plastic Armchair RAR Charles & Ray Eames
			18, 88	Eames Plastic Armchair PACC Charles & Ray Eames
257	Abalon	Ronan & Erwan Bouroullec	202	Eames Plastic Side Chair beam seating Charles & Ray Eames
360	Abalon Table	Ronan & Erwan Bouroullec	94	Eames Plastic Side Chair DSR Charles & Ray Eames
481	Abat-Jour Conique	Jean Prouvé	96	Eames Plastic Side Chair DSW Charles & Ray Eames
11, 59	AC 5 Meet	Antonio Citterio	98	Eames Plastic Side Chair DSX Charles & Ray Eames
10, 60	AC 5 Studio	Antonio Citterio	100	Eames Plastic Side Chair DSS Charles & Ray Eames
8	AC 5 Work	Antonio Citterio	102	Eames Plastic Side Chair DSS-N Charles & Ray Eames
196	Airline	Norman Foster	99	Eames Plastic Side Chair LSR Charles & Ray Eames
474	Akari Light Sculptures	Isamu Noguchi	19, 103	Eames Plastic Side Chair PSCC Charles & Ray Eames
272	Alcove Cabin	Ronan & Erwan Bouroullec	170	Eames Segmented Tables Dining Charles & Ray Eames
288	Alcove Plus Desk	Ronan & Erwan Bouroullec	392	Eames Storage Unit ESU Charles & Ray Eames
296	Alcove Plus Paravent	Ronan & Erwan Bouroullec	204	Eames Tandem Seating ETS Charles & Ray Eames
283	Alcove Plus Sofa	Ronan & Erwan Bouroullec	407	Eames Wool Blanket Charles & Ray Eames
285	Alcove Plus Work	Ronan & Erwan Bouroullec	228	East River Chair Hella Jongerius
260	Alcove Sofa	Ronan & Erwan Bouroullec	458	Elephant Pad Hella Jongerius
279	Alcove Work	Ronan & Erwan Bouroullec	382	Elephant Stool Sori Yanagi
426	Algue	Ronan & Erwan Bouroullec	363	Elliptical Table ETR Charles & Ray Eames
15	Allstar	Konstantin Grcic	172	EM Table Jean Prouvé
61	Aluminium Chairs EA 101/103/104	Charles & Ray Eames	408	Embroidered Pillows Alexander Girard
63	Aluminium Chairs EA 105/107/108	Charles & Ray Eames	104	EVO-C Jasper Morrison
12, 67	Aluminium Chairs EA 117/118/119	Charles & Ray Eames		<b>F</b>
70, 217	Aluminium Chair EA 124/125	Charles & Ray Eames	229	Fauteuil de Salon Jean Prouvé
16	AM Chair	Alberto Meda	105	Fauteuil Direction Jean Prouvé
216	Amoeba	Verner Panton	21	Fauteuil Direction Pivotant Jean Prouvé
455	Ampi	Vitra	364	Flower Table Alexander Girard
72	APC	Jasper Morrison	308	Freeform Sofa Isamu Noguchi
	<b>B</b>			<b>G</b>
73	Belleville Chair	Ronan & Erwan Bouroullec	434	Girard Bird Alexander Girard
162	Belleville Table	Ronan & Erwan Bouroullec	435	Girard Ornaments Alexander Girard
164	Bistro Table	Ronan & Erwan Bouroullec	23	Grand Conference Antonio Citterio
378	Bovist	Hella Jongerius	22	Grand Executive Antonio Citterio
379	Butterfly Stool	Sori Yanagi	230	Grand Relax Antonio Citterio
	<b>C</b>		248	Grand Repos Antonio Citterio
418	Ceramic Containers	Alexander Girard	297	Grand Sofà Antonio Citterio
75	Chaise Tout Bois	Jean Prouvé	409	Graphic Print Pillows Alexander Girard
380, 456	Chap	Konstantin Grcic	177	Guéridon Jean Prouvé
222	Cité	Jean Prouvé	365	Guéridon Bas Jean Prouvé
220	Citizen	Konstantin Grcic		<b>H</b>
420	Classic Trays	Various Designers	117	HAL RE Armchair Tube Stackable, RE Armchair Wood Jasper Morrison
398	Coat Dots	Hella Jongerius	206	HAL RE beam seating Jasper Morrison
223	Coconut Chair	George Nelson	121	HAL RE Barstool, Ply Barstool Jasper Morrison
421	Coffee Mugs	Alexander Girard	115	HAL RE Cantilever, RE Sledge Jasper Morrison
361	Coffee Table	Isamu Noguchi	232	HAL Lounge Chair Jasper Morrison
406	Colour Block Blankets	Hella Jongerius	111	HAL Soft Tube Jasper Morrison
188	Compas Direction	Jean Prouvé	112	HAL Soft Tube Stackable Jasper Morrison
224	Cone Chair	Verner Panton	110	HAL Soft Wood Jasper Morrison
427	Cork Bowl	Jasper Morrison	119	HAL RE Stool High, Ply Stool High, RE Stool Medium, Ply Stool Medium Jasper Morrison
381	Cork Family	Jasper Morrison	24, 112	HAL RE Studio, RE Armchair Studio Jasper Morrison
399	Corniches	Ronan & Erwan Bouroullec	108	HAL RE Tube, RE Tube Stackable, Ply Tube, Ply Tube Stackable Jasper Morrison
	<b>D</b>		113	HAL RE Tube Armrest, RE Tube Writing Tablet Jasper Morrison
470	Desk Clocks	George Nelson	106	HAL RE Wood, Ply Wood Jasper Morrison
176	Dining Table	Isamu Noguchi	400	Hang it all Charles & Ray Eames
457	Drop Box	Konstantin Grcic	459	Happy Bin Michel Charlat
	<b>E</b>		225	Heart Cone Chair Verner Panton
362	Eames Coffee Table	Charles & Ray Eames	410	Herringbone Pillows Raw-Edges
168	Eames Contract Tables	Charles & Ray Eames	437	Herringbone Vessels Raw-Edges
189	Eames Desk Unit EDU	Charles & Ray Eames	424	High Tray Jasper Morrison
428	Eames Elephant	Charles & Ray Eames	190	Home Desk George Nelson
429	Eames Elephant (Plywood)	Charles & Ray Eames		<b>I</b>
430	Eames Elephant (small)	Charles & Ray Eames	30	ID Air Antonio Citterio
76	Eames Fiberglass Armchairs	Charles & Ray Eames	28	ID Cloud Antonio Citterio
78	Eames Fiberglass Armchair LAR	Charles & Ray Eames	26	ID Chair Concept Antonio Citterio
79, 226	Eames Fiberglass Armchair RAR	Charles & Ray Eames	32	ID Mesh Antonio Citterio
80	Eames Fiberglass Side Chair DSR	Charles & Ray Eames	34	ID Soft Antonio Citterio
82	Eames Fiberglass Side Chair DSW	Charles & Ray Eames	36	ID Soft L Antonio Citterio
84	Eames Fiberglass Side Chair DSX	Charles & Ray Eames	38	ID Trím Antonio Citterio
85	Eames Fiberglass Side Chair LSR	Charles & Ray Eames	40	ID Trim L Antonio Citterio
			124	ID Visitor Antonio Citterio

# Alphabetical index by product

## Price list 2023

### K

- 461 Key Ring Hella Jongerius
- 462 Key Ring Sun Alexander Girard

### L

- 433 L'Oiseau Ronan & Erwan Bouroullec
- 242 La Chaise Charles & Ray Eames
- 478 Lampe de Bureau Jean Prouvé
- 128 Landi Chair Hans Coray
- 393 Living Tower Verner Panton
- 42 Lobby Chair ES 104 Charles & Ray Eames
- 129 Lobby Chair ES 105, 108 Charles & Ray Eames
- 463 Locker Box Konstantin Grcic
- 234 Lounge Chair & Ottoman Charles & Ray Eames

### M

- 464 Magnet Dots Hella Jongerius
- 309 Mariposa Club Armchair Edward Barber & Jay Osgerby
- 310 Mariposa Sofa Edward Barber & Jay Osgerby
- 209 Meda Gate Alberto Meda
- 131 MedaSlim Alberto Meda
- 366 Metal Side Tables Ronan & Erwan Bouroullec
- 438 Metal Wall Relief Alexander Girard
- 451 Miniatures Collection Vitra Design Museum
- 130 Moca Jasper Morrison

### N

- 383 Nelson Bench George Nelson
- 370 NesTable Jasper Morrison
- 440 Nuage Ronan & Erwan Bouroullec
- 441 Nuage (céramique) Ronan & Erwan Bouroullec

### O

- 465 O-Tidy Michel Charlot
- 371 Occasional Low Table Jasper Morrison
- 372 Occasional Table LTR Charles & Ray Eames
- 133 Organic Chair Charles Eames & Eero Saarinen
- 134 Organic Conference Charles Eames & Eero Saarinen
- 245 Organic Highback Charles Eames & Eero Saarinen

### P

- 136 Panton Chair Verner Panton
- 135 Panton Chair Classic Verner Panton
- 137 Panton Junior Verner Panton
- 480 Petite Potence Jean Prouvé
- 251 Petit Repos Antonio Citterio
- 43 Physix Alberto Meda
- 45 Physix Studio Alberto Meda
- 46 Pivot Counter Stool, Pivot High Stool, Pivot Stool Antonio Citterio
- 178 Plate Dining Table Jasper Morrison
- 373 Plate Table Jasper Morrison
- 138 Plywood Group DCM, DCW Charles & Ray Eames
- 139, 243 Plywood Group LCM, Calf's Skin, Leather Charles & Ray Eames
- 140, 244 Plywood Group LCW, Calf's Skin, Leather Charles & Ray Eames
- 442 Plywood Mobile Charles & Ray Eames
- 313 Polder Hella Jongerius
- 479 Potence Jean Prouvé
- 482 Publications Vitra Design Museum

### R

- 401 Rayonnage Mural Jean Prouvé
- 467 Repad Ronan & Erwan Bouroullec
- 246 Repos Antonio Citterio
- 250 Repos Ottoman Antonio Citterio
- 443 Resting Animals Front
- 48 Rookie Konstantin Grcic
- 49 Rookie High Konstantin Grcic
- 425 Rotary Tray Jasper Morrison

### S

- 466 S-Tidy Michel Charlot
- 411 Seat Dots Hella Jongerius
- 446 Silhouettes Alexander Girard
- 252 Slow Chair & Ottoman Ronan & Erwan Bouroullec
- 307, 422 Sofa Tray Antonio Citterio
- 315 Soft Modular Sofa Jasper Morrison
- 65 Soft Pad Chairs EA 205/207/208 Charles & Ray Eames
- 14, 69 Soft Pad Chairs EA 217/219 Charles & Ray Eames
- 71, 218 Soft Pad Chair EA 222/223 Charles & Ray Eames
- 219 Soft Pad Chaise ES 106 Charles & Ray Eames
- 50, 141 Softshell Chair Ronan & Erwan Bouroullec
- 143 Softshell Side Chair Ronan & Erwan Bouroullec
- 412 Soft Seats
- 192 Soft Wait Edward Barber & Jay Osgerby
- 192 Soft Work Edward Barber & Jay Osgerby
- 144 Standard Jean Prouvé
- 145 Standard SP Jean Prouvé
- 146 Stool-Tool Konstantin Grcic
- 384 Stools Charles & Ray Eames
- 356 Suita Club Armchair Antonio Citterio
- 355 Suita Club Sofa Antonio Citterio
- 352 Suita cushions Antonio Citterio
- 351 Suita Daybed Antonio Citterio
- 351 Suita Ottoman Antonio Citterio
- 322 Suita Sofa Antonio Citterio
- 180 Super Fold Table Jasper Morrison

### T

- 184 Table S.A.M. Bois Jean Prouvé
- 385 Tabouret 307 Jean Prouvé
- 386 Tabouret Bois Jean Prouvé
- 147 Tabouret Haut Jean Prouvé
- 387 Tabouret Métallique Jean Prouvé
- 447 Terracotta Pots Thélonius Goupil
- 148 Tip Ton Edward Barber & Jay Osgerby
- 149 Tip Ton RE Edward Barber & Jay Osgerby
- 468 Toolbox Arik Levy
- 185 Trapèze Jean Prouvé
- 423 Trays Jasper Morrison

### U

- 51, 150 Unix Chair Antonio Citterio
- 403 Uten.Silo Dorothee Becker

### V

- 448 Vases Découpage Ronan & Erwan Bouroullec
- 388 Visiona Stool Verner Panton
- 357 Vlinder Sofa Hella Jongerius

### W

- 471 Wall Clocks George Nelson
- 153, 389 Wiggle Side Chair Frank Gehry
- 153, 389 Wiggle Stool Frank Gehry
- 154 Wire Chair DKR, DKR-2, DKR-5, DKR Colours Charles & Ray Eames
- 156 Wire Chair DKW, DKW-2, DKW-5 Charles & Ray Eames
- 157 Wire Chair DKX, DKX-2, DKX-5 Charles & Ray Eames
- 158 Wire Chair LKR, LKR-2, LKR-5, LKR Colours Charles & Ray Eames
- 449 Wooden Dolls Alexander Girard
- 369 Wooden Side Tables Ronan & Erwan Bouroullec

### Z

- 473 Zoo Timers George Nelson

## Office and conference chairs (swivel)



.04  
Maarten Van Severen  
7



AC 5 Work  
Antonio Citterio  
8



AC 5 Studio  
Antonio Citterio  
10



AC 5 Meet  
Antonio Citterio  
11



EA 117/118/119  
Charles & Ray Eames  
12



EA 217/219  
Charles & Ray Eames  
14



Allstar  
Konstantin Grcic  
15



AM Chair  
Alberto Meda  
16



PACC  
Charles & Ray Eames  
18



PSCC  
Charles & Ray Eames  
19



Fauteuil Direction Pivotant  
Jean Prouvé  
21



Grand Executive  
Antonio Citterio  
22



Grand Conference  
Antonio Citterio  
23



HAL RE Studio  
Jasper Morrison  
24



HAL RE Armchair Studio  
Jasper Morrison  
25



ID Cloud  
Antonio Citterio  
28



ID Air  
Antonio Citterio  
30



ID Mesh  
Antonio Citterio  
32



ID Soft  
Antonio Citterio  
34



ID Soft L  
Antonio Citterio  
36



ID Trim  
Antonio Citterio  
38



ID Trim L  
Antonio Citterio  
40



Lobby Chair ES 104  
Charles & Ray Eames  
42



Physix  
Alberto Meda  
43



Physix Studio  
Alberto Meda  
45



Pivot Counter Stool  
Antonio Citterio  
46



Pivot High Stool  
Antonio Citterio  
46



Pivot Stool  
Antonio Citterio  
46



Rookie  
Konstantin Grcic  
48



Rookie High  
Konstantin Grcic  
49



Softshell Chair  
R & E Bouroullec  
50



Unix Chair  
Antonio Citterio  
51



## Office and conference chairs (swivel)

Chairs

Tables

Desks

Public waiting areas

Lounge chairs and armchairs

Sofas

Coffee and side tables

Stools and benches

Storage and partition elements

### Accessories

Living, dining, decorative objects, home office,  
clocks, lighting, publications

Quick Ship programme

General terms, conditions  
and information







# .04

## Maarten Van Severen, 2000



.04



.04 Counter



All measurements are pursuant to EN 1335-1:2000  
 More detailed information is found in the chapter 'Explanation of measurements'.

**Backrest and seat:** flexible backrest with integrated leaf springs. Polyurethane integral foam seat shell with upholstered effect, self-supporting on a steel frame.

**Armrests:** with or without armrests in integral foam.

**Micro-mechanism:** rubber ball joint allows multi-directional movement. Height-adjustable.

**Base:** five-star base and die-cast aluminium bridge, powder-coated. Fitted with castors or with plastic glides for carpet or felt glides for hard floors.

.04	Article no.	without VAT in SEK*	with VAT in SEK*
<b>without armrests</b>	<b>440 420 00</b>		
Base powder-coated in black	55	10.000,00	<b>12.500,00</b>
<b>with armrests</b>	<b>440 421 00</b>		
Base powder-coated in black	55	11.440,00	<b>14.300,00</b>

.04 Counter	Article no.	without VAT in SEK*	with VAT in SEK*
<b>without armrests</b>	<b>440 422 00</b>		
Base powder-coated in black	55	11.760,00	<b>14.700,00</b>
<b>with armrests</b>	<b>440 423 00</b>		
Base powder-coated in black	55	13.680,00	<b>17.100,00</b>

Seat shell	Castors/Glides .04	Castors/Glides .04 Counter
01 basic dark	02 castors hard, braked for carpet	04 glides for carpet
10 bright red	03 castors soft, braked for hard floor	05 felt glides for hard floor
77 dark green	04 glides for carpet	06 castors inversely braked
78 mango	05 felt glides for hard floor	

# AC 5 Work

Antonio Citterio, 2017

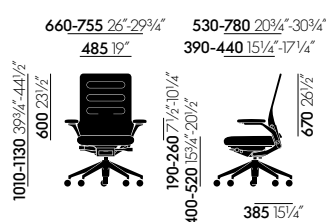

AC 5 Work with FreeFloat armrests and adjustable lumbar support

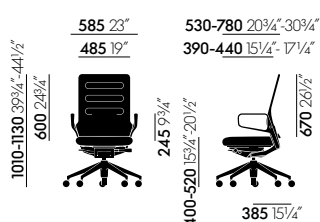

AC 5 Work with ring armrests and adjustable lumbar support

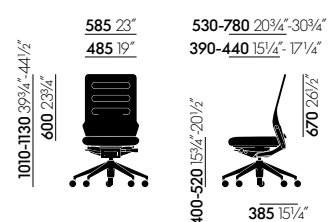

AC 5 Work without armrests, with adjustable lumbar support

All measurements are pursuant to EN 1335-1:2000  
More detailed information is found in the chapter 'Explanation of measurements'.

## Office swivel chair with FreeFloat armrests in accordance with EN 1335, Ergonomic Seal of Approval.

**Seat mechanism:** FlowMotion mechanism with synchronised forward tilt (can be disengaged) and with seat depth adjustment. Seat mechanism powder-coated in basic dark.

**Backrest and seat:** self-supporting backrest structure with horizontally stitched padding. Backrest mount in polished die-cast aluminium. Optional height-adjustable lumbar cushion. Seat cushion in polyurethane foam. Optionally available with contoured seat. Cover in fabric or leather.

**Armrests:** choice of fixed, polished die-cast aluminium ring armrests for conference areas (optional leather pads are matched to the leather upholstery; for chairs with fabric covers, the leather pads are in the colour nero); or height-adjustable armrests; or FreeFloat armrests with polyurethane pads in basic dark.

**Base:** five-star polyamide base in basic dark or polished die-cast aluminium base with double castors (Ø 60 mm) in basic dark.

# AC 5 Work

Antonio Citterio, 2017

vitra.



AC 5 Work	Article no.	without VAT in SEK*	with VAT in SEK*
<b>without adjustable lumbar support</b>	<b>421 025 00</b>		
Fabric F30		11.080,00	<b>13.850,00</b>
Fabric F60		11.728,00	<b>14.660,00</b>
Leather L20		17.808,00	<b>22.260,00</b>
Leather L50		21.712,00	<b>27.140,00</b>
<b>with adjustable lumbar support</b>	<b>421 026 00</b>		
Fabric F30		11.504,00	<b>14.380,00</b>
Fabric F60		12.152,00	<b>15.190,00</b>
Leather L20		18.232,00	<b>22.790,00</b>
Leather L50		22.136,00	<b>27.670,00</b>
<b>Surcharges armrests</b>			
without armrests	11	0,00	<b>0,00</b>
height-adjustable armrests	12	1.984,00	<b>2.480,00</b>
FreeFloat armrests	13	2.864,00	<b>3.580,00</b>
aluminium ring armrests	14	2.864,00	<b>3.580,00</b>
leather-covered aluminium ring armrests	15	3.640,00	<b>4.550,00</b>
<b>Surcharges seat</b>			
standard	0	0,00	<b>0,00</b>
contour seat	1	616,00	<b>770,00</b>
<b>Surcharges base</b>			
plastic basic dark	0	0,00	<b>0,00</b>
polished aluminium	1	1.592,00	<b>1.990,00</b>

Fabric F30	Fabric F60	Leather L20	Leather L50	Castors
. Plano	. Hopsak . Twill	. Leather	. Leather Premium F	02 castors hard, braked for carpet 03 castors soft, braked for hard floor

# AC 5 Studio

Antonio Citterio, 2017

vitra.



All measurements are pursuant to EN 1335-1:2000  
More detailed information is found in the chapter 'Explanation of measurements'.

**Studio chair (swivel, height-adjustable) in accordance with EN 16139.**

**Seat mechanism:** tilt mechanism, lockable in upright position. Mechanism housing in polished aluminium.

**Backrest:** self-supporting backrest construction with horizontally stitched padding. Cover in fabric or leather.

**Seat:** polyurethane foam padding. Cover in fabric or leather.

**Armrests:** without armrests or with polished die-cast aluminium ring armrests, optional leather pads (pads are matched to the leather upholstery; for chairs with fabric covers, the leather armrest pads are in the colour nero).

**Base:** five-star base in polished die-cast aluminium or plastic (basic dark) on double castors (Ø 60 mm). Swivel mount, height adjustable.

## AC 5 Studio

	Article no.	without VAT in SEK*	with VAT in SEK*
<b>five-star base</b>	<b>421 020 00</b>		
Fabric F30		7.832,00	<b>9.790,00</b>
Fabric F60		8.384,00	<b>10.480,00</b>
Leather L20		14.992,00	<b>18.740,00</b>
<b>Surcharges armrests</b>			
without armrests	11	0,00	<b>0,00</b>
aluminium ring armrests	14	2.224,00	<b>2.780,00</b>
leather-covered aluminium ring armrest	15	3.000,00	<b>3.750,00</b>
<b>Surcharges base</b>			
plastic basic dark	0	0,00	<b>0,00</b>
polished aluminium	1	1.592,00	<b>1.990,00</b>

Fabric F30	Fabric F60	Leather L20	Castors
. Plano	. Hopsak . Twill	. Leather	02 castors hard, braked for carpet 03 castors soft, braked for hard floor

# AC 5 Meet

Antonio Citterio, 2017

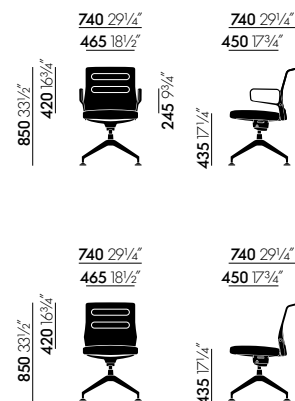

All measurements are pursuant to EN 1335-1:2000  
More detailed information is found in the chapter 'Explanation of measurements'.

## Conference chair (swivel) in accordance with EN 16139.

**Seat mechanism:** tilt mechanism, lockable in upright position. Mechanism housing in polished aluminium.

**Backrest:** self-supporting backrest construction with horizontally stitched padding. Cover in fabric or leather.

**Seat:** polyurethane foam padding. Cover in fabric or leather.

**Armrests:** without armrests or with polished die-cast aluminium ring armrests, optional leather pads (pads are matched to the leather upholstery; for chairs with fabric covers, the leather armrest pads are in the colour nero).

**Base:** four-star base in polished die-cast aluminium on glides. Swivel mount with shock-absorbing seat suspension.

## AC 5 Meet

	Article no.	without VAT in SEK*	with VAT in SEK*
<b>four-star base</b>	<b>421 021 00</b>		
Fabric F30		9.424,00	<b>11.780,00</b>
Fabric F60		9.976,00	<b>12.470,00</b>
Leather L20		16.584,00	<b>20.730,00</b>
<b>Surcharges armrests</b>			
without armrests	11	0,00	<b>0,00</b>
aluminium ring armrests	14	2.224,00	<b>2.780,00</b>
leather-covered aluminium ring armrest	15	3.000,00	<b>3.750,00</b>

Fabric F30	Fabric F60	Leather L20	Glides
. Plano	. Hopsak . Twill	. Leather	04 glides for carpet 05 felt glides for hard floor



# Aluminium Chairs EA 117/118/119

## Charles & Ray Eames, 1958

vitra.



EA 117	Article no.	without VAT in SEK*	with VAT in SEK*
<b>medium-high backrest, swivel</b>	<b>412 364 00</b>		
with armrests			
Fabric F60		26.080,00	<b>32.600,00</b>
Leather L20		32.400,00	<b>40.500,00</b>
Leather L50		37.200,00	<b>46.500,00</b>
<b>Surcharges base</b>			
polished	1	0,00	<b>0,00</b>
powder-coated in deep black	4	0,00	<b>0,00</b>
chromed	0	2.032,00	<b>2.540,00</b>

EA 118	Article no.	without VAT in SEK*	with VAT in SEK*
<b>medium-high backrest, swivel</b>	<b>412 329 00</b>		
with armrests			
Fabric F60		23.680,00	<b>29.600,00</b>
Leather L20		29.360,00	<b>36.700,00</b>
Leather L50		34.000,00	<b>42.500,00</b>
<b>Surcharges base</b>			
polished	1	0,00	<b>0,00</b>
powder-coated in deep black	4	0,00	<b>0,00</b>
chromed	0	2.032,00	<b>2.540,00</b>

EA 119	Article no.	without VAT in SEK*	with VAT in SEK*
<b>high backrest, swivel</b>	<b>412 365 00</b>		
with armrests			
Fabric F60		31.840,00	<b>39.800,00</b>
Leather L20		38.960,00	<b>48.700,00</b>
Leather L50		44.320,00	<b>55.400,00</b>
<b>Surcharges base</b>			
polished	1	0,00	<b>0,00</b>
powder-coated in deep black	4	0,00	<b>0,00</b>
chromed	0	2.920,00	<b>3.650,00</b>

Fabric F60	Leather L20	Leather L50	Castors
. Hopsak	. Leather/back panel Plano	. Leather Premium F/back panel Plano	02 castors hard, braked for carpet 03 castors soft, braked for hard floor

# Soft Pad Chairs EA 217/219

## Charles & Ray Eames, 1969

vitra.



EA 217



EA 219

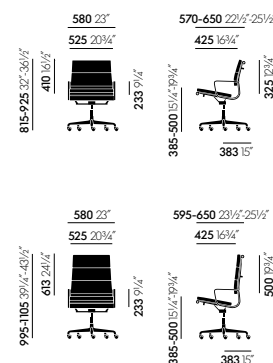

All measurements are pursuant to EN 1335-1:2000  
 More detailed information is found in the chapter 'Explanation of measurements'.

**Backrest and seat:** EA 217 with medium-high backrest, EA 219 with high backrest. Sewn-on cushions with polyurethane foam upholstery in leather. Side profiles and spreaders in die-cast aluminium, with a polished or chrome-plated finish or powder-coated in deep black.

**Seat mechanism:** adjustable backward tilt, lockable in the forward position. Continuous seat height adjustment with gas spring.

**Armrests:** die-cast aluminium, with a polished or chrome-plated finish or powder-coated in deep black.

**Base:** five-star base in die-cast aluminium, with a polished or chrome-plated finish or powder-coated in deep black. Equipped with hard castors for carpet or soft castors for hard floors. Castor covers in black for polished and black powder-coated base, with chrome-plated finish for chrome base.

EA 217	Article no.	without VAT in SEK*	with VAT in SEK*
<b>medium-high backrest, swivel</b>	<b>412 381 00</b>		
with armrests			
Leather L20		34.400,00	<b>43.000,00</b>
Leather L50		40.240,00	<b>50.300,00</b>
<b>Surcharges base</b>			
polished	1	0,00	<b>0,00</b>
powder-coated in deep black	4	0,00	<b>0,00</b>
chromed	0	2.032,00	<b>2.540,00</b>

EA 219	Article no.	without VAT in SEK*	with VAT in SEK*
<b>high backrest, swivel</b>	<b>412 382 00</b>		
with armrests			
Leather L20		42.080,00	<b>52.600,00</b>
Leather L50		49.600,00	<b>62.000,00</b>
<b>Surcharges base</b>			
polished	1	0,00	<b>0,00</b>
powder-coated in deep black	4	0,00	<b>0,00</b>
chromed	0	2.920,00	<b>3.650,00</b>

#### Leather L20

Leather/back panel Plano

#### Leather L50

Leather Premium F (contrast seam)/back panel Plano

#### Castors

02 castors hard, braked for carpet  
 03 castors soft, braked for hard floor



# Allstar

Konstantin Grcic, 2014

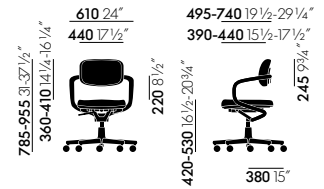

All measurements are pursuant to EN 1335-1:2000  
 More detailed information is found in the chapter 'Explanation of measurements'.

### Office swivel chair in accordance with EN 1335.

**Backrest and seat:** backrest in polyamide, coated with polyurethane foam. Backrest height adjustable up to 5 cm using a quick release lever. Seat with contouring on the front edge, consisting of a polyamide seat plate and polyurethane foam. Covers in fabric or leather, freely stretched over the surfaces of the seat and backrest.

**Armrest/back bracket:** loop frame made of polyamide that simultaneously serves as the armrest structure, backrest support and extended arm of the mechanical unit.

**Mechanical unit:** the synchronised mechanism can be locked in the upright position. Equipped as standard with seat height and seat depth adjustment. Plastic in the colour deep black.

**Base:** five-star base in polyamide (deep black) with double castors (Ø 60 mm, basic dark).

Allstar	Article no.	without VAT in SEK*	with VAT in SEK*
<b>Allstar</b>	<b>419 001 00</b>		
Silk Mesh		8.256,00	<b>10.320,00</b>
Fabric F60		9.040,00	<b>11.300,00</b>
Fabric F80		9.336,00	<b>11.670,00</b>
Leather L20		12.192,00	<b>15.240,00</b>

Fabric F60	Fabric F80	Leather L20	Technical textile	Armrests/back bracket	Castors
. Hopsak . Volo	. Tress	. Leather	. Silk Mesh	04 white 12 deep black	02 castors hard, braked for carpet 03 castors soft, braked for hard floor

# AM Chair

Alberto Meda, 2016

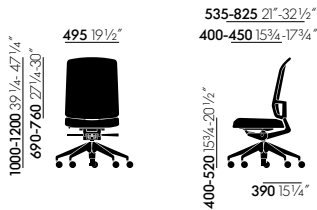

AM Chair without armrests

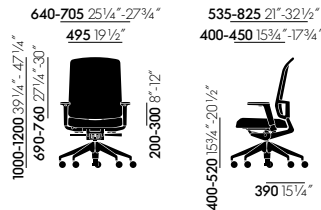

AM Chair with 2D armrests

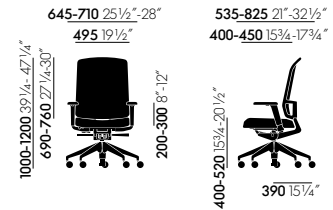

AM Chair with 3D armrests

All measurements are pursuant to EN 1335-1:2000  
 More detailed information is found in the chapter 'Explanation of measurements'.

**Office swivel chair in accordance with EN 1335, Ergonomic Seal of Approval (LGA Nuremberg).**

**Seat mechanism:** ProMotion mechanism, lockable in upright position. Synchronised mechanism with automatic weight adjustment and manual fine tuning of backrest resistance via 180° rotation. Equipped as standard with seat height and seat depth adjustment. Optionally available with or without spontaneous forward tilt (can be disengaged).

**Seat:** seat plate made of polyamide; contoured seat cushion made of polyurethane foam; fabric cover.

**Back:** mesh backrest in LightNet, stretched over frame; fabric backrest in Plano (reverse side in Verso fabric, colour sierra grey). Polyamide backrest frame in deep black. Height-adjustable backrest as a standard feature.

**Armrests:** 2D armrests with adjustable height and width or 3D armrests with adjustable height, width and depth. Armrest supports in polyamide with polyurethane pads, both in deep black.

**Base:** five-star base in polyamide (deep black) or in powder-coated aluminium (deep black). Equipped with double castors (Ø 60 mm).

# AM Chair

Alberto Meda, 2016

**vitra.**



AM Chair	Article no.	without VAT in SEK*	with VAT in SEK*
<b>with mesh backrest</b>	<b>417 050 00</b>		
Seat fabric F30, backrest LightNet		6.712,00	<b>8.390,00</b>
<b>with fabric backrest</b>	<b>417 055 00</b>		
Seat fabric F30, backrest fabric (front F30 / back Verso)		7.808,00	<b>9.760,00</b>
<b>Surcharges armrests</b>			
without armrests	00	0,00	<b>0,00</b>
2D armrests	11	1.288,00	<b>1.610,00</b>
3D armrests	12	2.000,00	<b>2.500,00</b>
<b>Surcharges mechanical elements</b>			
ProMotion without forward tilt, with seat depth adjustment	31	0,00	<b>0,00</b>
ProMotion with forward tilt, with seat depth adjustment	32	560,00	<b>700,00</b>
<b>Surcharges base</b>			
plastic, deep black	21	0,00	<b>0,00</b>
aluminium powder-coated in deep black	22	1.504,00	<b>1.880,00</b>

## Quickship

AM Chair, seat cover in Plano nero, back cover in LightNet black	Article no.	without VAT in SEK*	with VAT in SEK*
<b>Hard braked castors for carpet</b>	<b>QS1 705 0A</b>	8.000,00	<b>10.000,00</b>
ProMotion mechanism with seat depth adjustment, no forward tilt, armrests and back frame in deep black, 2D-armrests, plastic base in deep black			
<b>Soft braked castors for hard floors</b>	<b>QS1 705 0B</b>	8.000,00	<b>10.000,00</b>
ProMotion mechanism with seat depth adjustment, no forward tilt, armrests and back frame in deep black, 2D-armrests, plastic base in deep black			

Fabric F30	Netweave backrest LightNet	Armrests/back brace	Castors
Plano	01 black 02 sierra grey 03 white	12 deep black	02 castors hard, braked for carpet 03 castors soft, braked for hard floor

# Eames Plastic Armchair PACC

Charles & Ray Eames, 1950

vitra.

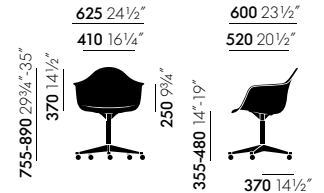

All measurements are pursuant to EN 1335-1:2000  
More detailed information is found in the chapter 'Explanation of measurements'.

**Seat shell:** dyed-through polypropylene. All models are available with a seat cushion (screwed to the seat shell) or full upholstery. The fully upholstered version has moulded polyurethane foam padding covered in fabric, attached to the shell with a welted edge. Different shell and upholstery colours and various bases provide a multitude of possible combinations.

**Options:** the Eames Plastic Chair is available as a visitor chair, dining chair, rocking chair, swivel chair or in stacking versions and with ganging brackets for row seating. Beam-mounted shells are suited for use in waiting areas.

## Eames Plastic Armchair PACC

**Base:** five-star base in polished die-cast aluminium with double castors in basic dark. (PACC = Pivot Armchair Cast Base on Castors)

PACC	Article no.	without VAT in SEK*	with VAT in SEK*
<b>castor-based swivel chair, height-adjustable</b>	<b>440 355 00</b>		
without upholstery		6.984,00	<b>8.730,00</b>
<b>castor-based swivel chair, height-adjustable</b>	<b>440 356 00</b>		
with seat upholstery			
Fabric F60		7.936,00	<b>9.920,00</b>
Fabric F200		9.184,00	<b>11.480,00</b>
<b>castor-based swivel chair, height-adjustable</b>	<b>440 357 00</b>		
with full upholstery			
Fabric F60		9.800,00	<b>12.250,00</b>

Fabric F60	Fabric F200	Seat shell	Edge	Castors
Hopsak	Checker	03 poppy red 04 white 11 pebble 12 deep black 23 ice grey 24 light grey 26 sunlight	34 mustard 41 pale rose 42 green 43 rusty orange 48 forest 56 granite grey 83 sea blue	01 basic dark 04 white 02 castors hard, braked for carpet 03 castors soft, braked for hard floor

# Eames Plastic Side Chair PSCC

Charles & Ray Eames, 1950

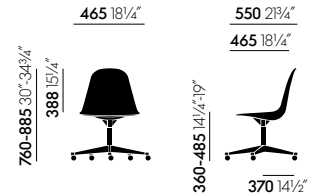

All measurements are pursuant to EN 1335-1:2000  
More detailed information is found in the chapter 'Explanation of measurements'.

**Seat shell:** dyed-through polypropylene. All models are available with a seat cushion (screwed to the seat shell) or full upholstery. The fully upholstered version has moulded polyurethane foam padding covered in fabric, attached to the shell with a welted edge. Different shell and upholstery colours and various bases provide a multitude of possible combinations.

**Options:** the Eames Plastic Chair is available as a visitor chair, dining chair, rocking chair, swivel chair or in stacking versions and with ganging brackets for row seating. Beam-mounted shells are suited for use in waiting areas.

**Base:** five-star base in polished die-cast aluminium with double castors in basic dark. (PSCC = Pivot Side Chair Cast Base on Castors)

PSCC	Article no.	without VAT in SEK*	with VAT in SEK*
<b>castor-based swivel chair, height-adjustable</b>	<b>440 335 00</b>		
without upholstery		5.848,00	<b>7.310,00</b>
<b>castor-based swivel chair, height-adjustable</b>	<b>440 336 00</b>		
with seat upholstery			
Fabric F60		6.872,00	<b>8.590,00</b>
Fabric F200		8.056,00	<b>10.070,00</b>
<b>castor-based swivel chair, height-adjustable</b>	<b>440 337 00</b>		
with full upholstery			
Fabric F60		7.880,00	<b>9.850,00</b>
Fabric F200		10.280,00	<b>12.850,00</b>

Fabric F60	Fabric F200	Seat shell	Edge	Castors
Hopsak	Checker	03 poppy red 04 white 11 pebble 12 deep black 23 ice grey 24 light grey 26 sunlight	34 mustard 41 pale rose 42 green 43 rusty orange 48 forest 56 granite grey 83 sea blue	01 basic dark 04 white 02 castors hard, braked for carpet 03 castors soft, braked for hard floor



# Fauteuil Direction Pivotant

Jean Prouvé, 1951

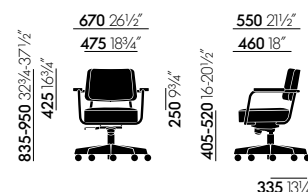

All measurements are pursuant to EN 1335-1:2000  
More detailed information is found in the chapter 'Explanation of measurements'.

**Seat and backrest:** polyurethane filling; cover in fabric or leather.

**Armrests:** solid wood in natural oak with oiled finish, dark stained oak with protective natural lacquer finish, or American walnut with oiled finish.

**Base:** five-star base made of bent sheet steel and tubular steel, powder-coated (smooth). Equipped with double castors in basic dark, Ø 60 mm.

**Seat mechanism:** adjustable backward tilt, lockable in the forward position. Continuous seat height adjustment with gas spring.

**Origin of wood:** oak (*Quercus robur*) from Western Europe and/or Poland; American walnut (*Juglans nigra*) from the USA.

**Note:** the steel frame in Métal Brut has a raw irregular surface protected by a transparent powder coating.

## Fauteuil Direction Pivotant

	Article no.	without VAT in SEK*	with VAT in SEK*
	<b>210 474 00</b>		
Backrest and seat fabric F60		25.336,00	<b>31.670,00</b>
Backrest and seat fabric F80		25.888,00	<b>32.360,00</b>
Backrest and seat leather L50		33.672,00	<b>42.090,00</b>
<b>Surcharges base</b>			
Colour group 1		0,00	<b>0,00</b>
Colour group 2		920,00	<b>1.150,00</b>

Fabric F60	Fabric F80	Leather L50	Armrests	Castors
<ul style="list-style-type: none"> <li>06 Twill</li> <li>07 Volo</li> </ul>	<ul style="list-style-type: none"> <li>08 Tress</li> </ul>	<ul style="list-style-type: none"> <li>09 Leather Premium F</li> </ul>	<ul style="list-style-type: none"> <li>04 dark stained solid oak, with protective varnish</li> <li>70 natural solid oak, oiled</li> <li>75 solid American walnut, oiled</li> </ul>	<ul style="list-style-type: none"> <li>02 castors hard, braked for carpet</li> <li>03 castors soft, braked for hard floor</li> </ul>

### Base frame Colour group 1

- 06 Japanese red powder-coated (smooth)
- 12 deep black powder-coated (smooth)
- 88 Prouvé Blanc Colombe (Ecrû) powder-coated (smooth)

### Base frame Colour group 2

- 13 Prouvé Gris Vermeer powder-coated (smooth)
- 14 Prouvé Bleu Dynastie powder-coated (smooth)
- 18 Prouvé Blé Vert powder-coated (smooth)
- 41 Prouvé Bleu Marcoule powder-coated (smooth)
- 94 Prouvé Métal Brut powder-coated (transparent, smooth)

# Grand Executive

Antonio Citterio, 2014



Grand Executive Lowback



Grand Executive Highback

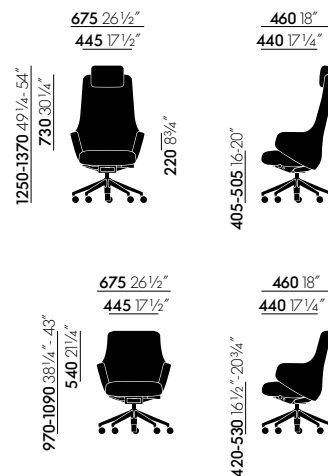

All measurements are pursuant to EN 1335-1:2000  
 More detailed information is found in the chapter 'Explanation of measurements'.

## Executive armchair in accordance with EN 1335.

**Mechanism:** FlowMotion mechanism with individual adjustment of backrest resistance.

**Backrest and seat:** seat shell with integrated armrests and height-adjustable neck cushion (Highback). Backrest shell made of plastic; seat and back upholstery made of polyurethane foam. Leather cover.

**Base:** five-star base in polished die-cast aluminium. With double castors (Ø 60 mm) for hard and soft floors in in basic dark.

**Grand Executive Highback:** high backrest with height-adjustable neck cushion.

**Grand Executive Lowback:** medium-height backrest without neck cushion.

## Grand Executive Highback

	Article no.	without VAT in SEK*	with VAT in SEK*
	<b>421 935 00</b>		
Leather L20		38.880,00	<b>48.600,00</b>
Leather L50		48.048,00	<b>60.060,00</b>

## Grand Executive Lowback

	Article no.	without VAT in SEK*	with VAT in SEK*
	<b>421 937 00</b>		
Leather L20		28.600,00	<b>35.750,00</b>
Leather L50		35.008,00	<b>43.760,00</b>

### Leather L20

Leather

### Leather L50

Leather Premium F

### Castors

02 castors hard, braked for carpet  
 03 castors soft, braked for hard floor



# Grand Conference

## Antonio Citterio, 2014

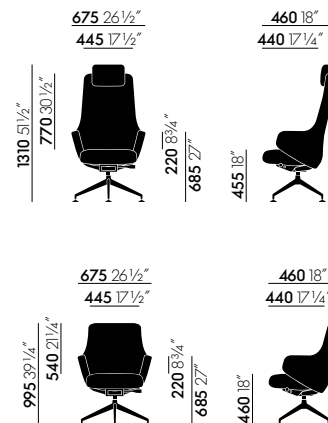

Grand Conference Lowback

Grand Conference Highback

All measurements are pursuant to EN 1335-1:2000  
More detailed information is found in the chapter 'Explanation of measurements'.

### Conference chair (swivel) in accordance with EN 16139.

**Mechanism:** FlowMotion conference mechanism with individual adjustment of backrest resistance. Fixed seat height with shock-absorbing seat suspension for added comfort.

**Backrest and seat:** seat shell with integrated armrests and height-adjustable neck cushion (Highback). Backrest shell made of plastic; seat and back upholstery made of polyurethane foam. Leather cover.

**Base:** four-star base in polished die-cast aluminium. Fitted with plastic glides for carpet or felt glides for hard floors.

**Grand Conference Highback:** high backrest with height-adjustable neck cushion.

**Grand Conference Lowback:** medium-height backrest without neck cushion.

### Grand Conference Highback

	Article no.	without VAT in SEK*	with VAT in SEK*
	<b>421 936 00</b>		
Leather L20		38.880,00	<b>48.600,00</b>
Leather L50		48.048,00	<b>60.060,00</b>

### Grand Conference Lowback

	Article no.	without VAT in SEK*	with VAT in SEK*
	<b>421 938 00</b>		
Leather L20		28.600,00	<b>35.750,00</b>
Leather L50		35.008,00	<b>43.760,00</b>

#### Leather L20

Leather

#### Leather L50

Leather Premium F

#### Glides

04 glides for carpet  
05 felt glides for hard floor

# HAL RE Studio

Jasper Morrison, 2010/2014

vitra.

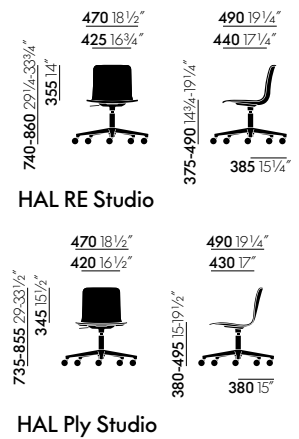

All measurements are pursuant to EN 1335-1:2000  
More detailed information is found in the chapter 'Explanation of measurements'.

## HAL RE Studio

**Seat shell:** dyed-through, recycled polypropylene.

**Base:** five-star base in die-cast aluminium powder-coated in basic dark. Swivel mechanism with shock-absorbing seat suspension, height-adjustable.

## HAL Ply Studio

**Seat shell:** plywood (USA).

**Base:** five-star base in die-cast aluminium powder-coated in basic dark. Swivel mechanism with shock-absorbing seat suspension, height-adjustable.

## HAL RE Studio

	Article no.	without VAT in SEK*	with VAT in SEK*
<b>five-star base</b>	<b>440 517 00</b>		
Base powder-coated basic dark, without seat upholstery		4.376,00	<b>5.470,00</b>
<b>five-star base</b>	<b>440 518 00</b>		
Base powder-coated basic dark, with seat upholstery F60		5.464,00	<b>6.830,00</b>

## HAL Ply Studio

	Article no.	without VAT in SEK*	with VAT in SEK*
<b>five-star base</b>	<b>440 229 00</b>		
Base powder-coated basic dark, seat shell natural oak, with protective varnish	01	6.360,00	<b>7.950,00</b>
Base powder-coated basic dark, seat shell dark oak, with protective varnish	02	6.360,00	<b>7.950,00</b>

### Seat fabric F60

### Seat shell HAL RE

### Castors

Hopsak	12 deep black RE 14 ivy RE 23 ice grey RE 29 brick RE 31 warm grey RE 35 basalt RE 85 cotton white RE 86 cardboard RE	02 castors hard, braked for carpet 03 castors soft, braked for hard floor
--------	--	--

# HAL RE Armchair Studio

Jasper Morrison, 2010/2014

vitra.

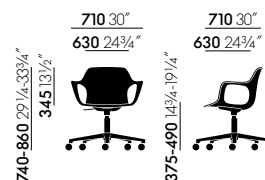

HAL RE Armchair Studio

All measurements are pursuant to EN 1335-1:2000  
More detailed information is found in the chapter 'Explanation of measurements'.

## HAL RE Armchair Studio

**Seat shell:** dyed-through recycled polypropylene, with optional seat cushion (screwed to the seat shell).

**Base:** five-star base in die-cast aluminium powder-coated in basic dark. Swivel mechanism with shock-absorbing seat suspension, height-adjustable.

## HAL RE Armchair Studio

	Article no.	without VAT in SEK*	with VAT in SEK*
<b>five-star base</b>	<b>440 515 00</b>		
Base powder-coated basic dark, without seat upholstery		4.976,00	<b>6.220,00</b>
<b>five-star base</b>	<b>440 516 00</b>		
Base powder-coated basic dark, with seat upholstery F60		6.064,00	<b>7.580,00</b>

### Seat fabric F60

### Seat shell HAL RE

### Castors

Hopsak	12 deep black RE 14 ivy RE 23 ice grey RE 29 brick RE 31 warm grey RE 35 basalt RE 85 cotton white RE 86 cardboard RE	02 castors hard, braked for carpet 03 castors soft, braked for hard floor
--------	--	--

# ID Chair Concept

Antonio Citterio, 2010/2021

---



---

## ID Chair Concept

ID Chair Concept is a chair system that can be configured based on the user's individual needs and preferences and gives the office a subtly elegant design and bright colours.

The office swivel chair range is made up of many components to satisfy a wide number of requirements in terms of aesthetics, materials, purpose and price. The right ID Chair can be chosen based on the following models:

- **ID Cloud** with membrane structure backrest
- **ID Air** with perforated plastic backrest.
- **ID Mesh** with padded mesh backrest.
- **ID Soft** with classic upholstered backrest.
- **ID Soft L** with high backrest.
- **ID Trim** with narrow backrest.
- **ID Trim L** with high backrest.

Starting with these models, different ID Chairs can be configured by selecting from the diverse mechanisms, seats, armrests, bases, frame colours and covers.

# ID Chair Concept

Antonio Citterio, 2010/2021



## Armrests

1. 3D armrests F
2. 2D armrests F
3. Ring armrests

## Accessories

1. Headrest and clothes hanger (ID Mesh)
2. Clothes hanger (ID Soft L, ID Trim, ID Trim L)

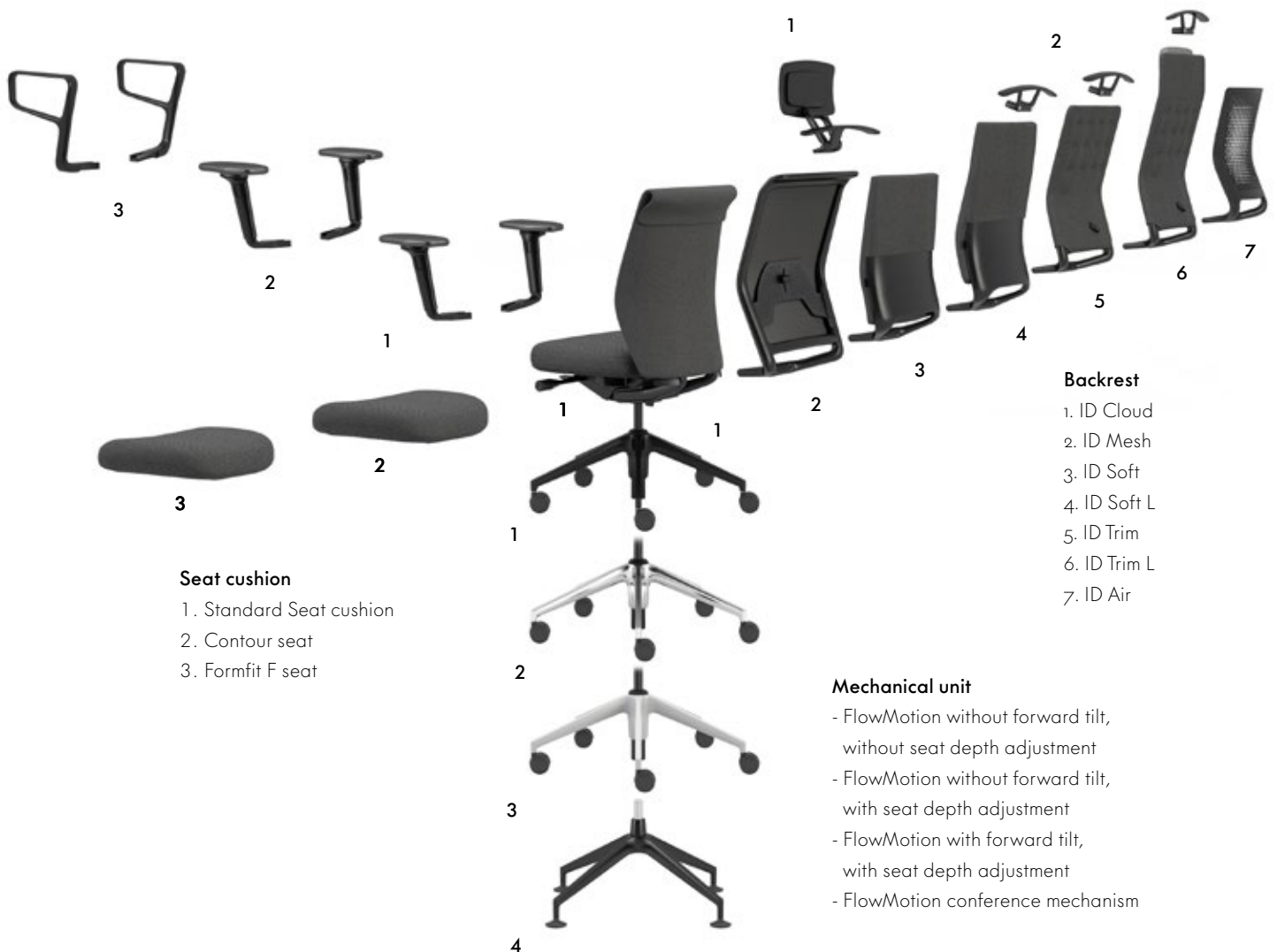

## Seat cushion

1. Standard Seat cushion
2. Contour seat
3. Formfit F seat

## Backrest

1. ID Cloud
2. ID Mesh
3. ID Soft
4. ID Soft L
5. ID Trim
6. ID Trim L
7. ID Air

## Mechanical unit

- FlowMotion without forward tilt, without seat depth adjustment
- FlowMotion without forward tilt, with seat depth adjustment
- FlowMotion with forward tilt, with seat depth adjustment
- FlowMotion conference mechanism

## Bases

1. Five-star base, plastic in basic dark
2. Five-star base, polished aluminium
3. Five-star base, coated aluminium
4. Four-star base, aluminium coated/polished

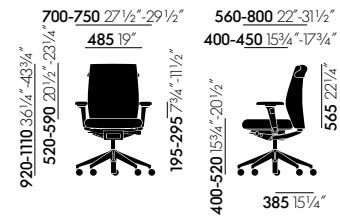
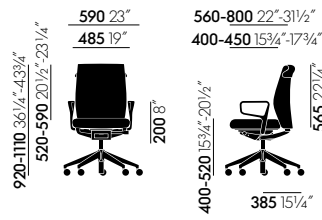
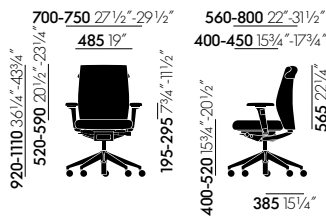

ID Cloud with 2D armrests

ID Cloud with ring armrests

ID Cloud with 2D armrests

All measurements are pursuant to EN 1335-1:2000  
More detailed information is found in the chapter 'Explanation of measurements'.

### Office swivel chair with 2D or 3D armrests in accordance with EN 1335, Ergonomic Seal of Approval (LGA Nuremberg).

**Seat mechanism:** FlowMotion mechanism, lockable in upright sitting position. Seat mechanism matches the frame colour (basic dark or soft grey). Optionally with or without synchronous forward tilt (can be disabled) or seat depth adjustment. Individual adjustment of backrest resistance and forward tilt.

**Backrest:** height-adjustable backrest with a three-part construction: frame in polyamide, membrane in TPE and knit cover. Back connection in basic dark or soft grey. Knit cover in Duo Knit.

**Armrests:** 2D armrests with adjustable height and width or 3D armrests with adjustable height, width and depth and 360° swivel function. Armrest supports in aluminium, polished or powder-coated in the colours basic dark or soft grey (to match the frame colour). Armrest sleeves in polyamide are matched to the frame colour (basic dark or soft grey). With PU-foam-free (F) pads in basic dark (for frame colour basic dark) or dim grey (for frame colour soft grey). Optionally available with ring armrests for use in conference settings, made of die-cast aluminium, polished or powder-coated in basic dark or soft grey (to match the frame colour).

**Seat:** polyurethane foam padding. Optional contour seat or PU-foam-free formfit (F) seat. Seat cover in woven fabric or 3D spacer fabric.

**Base:** five-star base in polyamide (basic dark) or die-cast aluminium, polished or powder-coated in basic dark or soft grey (to match the frame colour), with double castors (Ø 60 mm) or glides.

**Conference version:** conference chair (swivel) with four-star base made of die-cast aluminium, polished or powder-coated in basic dark or soft grey (to match frame colour) on glides in accordance with EN 16139. FlowMotion conference mechanism (no forward tilt, no seat depth adjustment) with individual adjustment of backrest resistance; fixed seat height with shock-absorbing seat suspension for added comfort.

# ID Cloud

## Antonio Citterio, 2021



ID Cloud	Article no.	without VAT in SEK*	with VAT in SEK*
<b>431 409 00</b>			
Backrest Duo Knit, seat Silk Mesh		8.936,00	<b>11.170,00</b>
Backrest Duo Knit, seat fabric F30		8.936,00	<b>11.170,00</b>
Backrest Duo Knit, seat fabric F40		9.048,00	<b>11.310,00</b>
Backrest Duo Knit, seat fabric F60		9.320,00	<b>11.650,00</b>
<b>Surcharges mechanical elements</b>			
FlowMotion without forward tilt, without seat depth adjustment	11	0,00	<b>0,00</b>
FlowMotion without forward tilt, with seat depth adjustment	13	560,00	<b>700,00</b>
FlowMotion with forward tilt, with seat depth adjustment	14	1.176,00	<b>1.470,00</b>
FlowMotion conference mechanism	17	0,00	<b>0,00</b>
<b>Surcharges seat</b>			
standard seat	01	0,00	<b>0,00</b>
Contour seat (only for mechanism with seat depth adjustment)	02	616,00	<b>770,00</b>
Formfit F seat (only for mechanism with seat depth adjustment / in Plano, Silk Mesh or Reflect)	03	616,00	<b>770,00</b>
<b>Surcharges armrests</b>			
without armrests	21	0,00	<b>0,00</b>
2D armrests F, polished aluminium	23	1.488,00	<b>1.860,00</b>
2D armrests F, powder-coated aluminium	24	1.488,00	<b>1.860,00</b>
3D armrests F, polished aluminium	25	2.136,00	<b>2.670,00</b>
3D armrests F, powder-coated aluminium	29	2.136,00	<b>2.670,00</b>
ring armrests, polished aluminium	27	2.136,00	<b>2.670,00</b>
ring armrests, powder-coated aluminium	28	2.136,00	<b>2.670,00</b>
<b>Surcharges base</b>			
five-star base, plastic, basic dark	31	0,00	<b>0,00</b>
five-star base, polished aluminium	32	1.592,00	<b>1.990,00</b>
five-star base, powder-coated aluminium	30	1.592,00	<b>1.990,00</b>
four-star base, polished aluminium (only for FlowMotion conference)	33	1.592,00	<b>1.990,00</b>
four-star base, powder-coated aluminium	34	1.592,00	<b>1.990,00</b>

Fabric F30	Fabric F40	Fabric F60	Frame	Castors/Glides
Plano	Laser RE Reflect	Volo	30 basic dark 53 soft grey	02 castors hard, braked for carpet 03 castors soft, braked for hard floor 04 glides for carpet 05 felt glides for hard floor

## ID Air

Antonio Citterio, 2012/2021

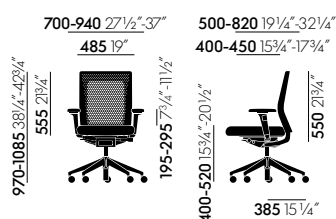

ID Air with 3D armrests

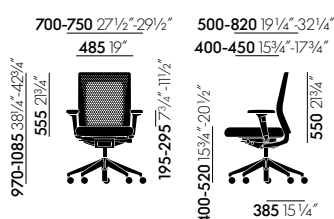

ID Air with 2D armrests

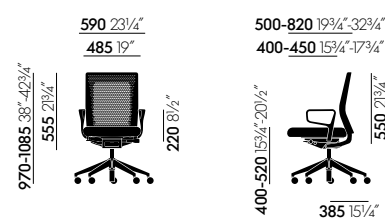

ID Air with fixed ring armrests

All measurements are pursuant to EN 1335-1:2000

More detailed information is found in the chapter 'Explanation of measurements'.

### Office swivel chair with 2D or 3D armrests in accordance with EN 1335, Ergonomic Seal of Approval (LGA Nuremberg).

**Seat mechanism:** FlowMotion mechanism, lockable in upright sitting position. Seat mechanism matches the frame colour (basic dark or soft grey). Optionally with or without synchronous forward tilt (can be disabled) or seat depth adjustment. Individual adjustment of backrest resistance and forward tilt.

**Backrest:** perforated plastic backrest in polypropylene (basic dark or soft grey).

**Armrests:** 2D armrests with adjustable height and width or 3D armrests with adjustable height, width and depth and 360° swivel function. Armrest supports in aluminium, polished or powder-coated in the colours basic dark or soft grey (to match the frame colour). Armrest sleeves in polyamide are matched to the frame colour (basic dark or soft grey). With PU-foam-free (F) pads in basic dark (for frame colour basic dark) or dim grey (for frame colour soft grey). Optionally available with ring armrests for use in conference settings, made of die-cast aluminium, polished or powder-coated in basic dark or soft grey (to match the frame colour).

**Seat:** polyurethane foam padding. Optional contour seat or PU-foam-free formfit (F) seat. Seat cover in woven fabric or 3D spacer fabric.

**Base:** five-star base in polyamide (basic dark) or die-cast aluminium, polished or powder-coated in basic dark or soft grey (to match the frame colour), with double castors (Ø 60 mm) or glides.

**Conference version:** conference chair (swivel) with four-star base made of die-cast aluminium, polished or powder-coated in basic dark or soft grey (to match frame colour) on glides in accordance with EN 16139. FlowMotion conference mechanism (no forward tilt, no seat depth adjustment) with individual adjustment of backrest resistance; fixed seat height with shock-absorbing seat suspension for added comfort.





ID Air	Article no.	without VAT in SEK*	with VAT in SEK*
	<b>431 407 00</b>		
Seat Silk Mesh		6.584,00	<b>8.230,00</b>
Seat fabric F30		6.584,00	<b>8.230,00</b>
Seat fabric F40		6.704,00	<b>8.380,00</b>
Seat fabric F60		6.928,00	<b>8.660,00</b>
<b>Surcharges mechanical elements</b>			
FlowMotion without forward tilt, without seat depth adjustment	11	0,00	<b>0,00</b>
FlowMotion without forward tilt, with seat depth adjustment	13	560,00	<b>700,00</b>
FlowMotion with forward tilt, with seat depth adjustment	14	1.176,00	<b>1.470,00</b>
FlowMotion conference mechanism	17	0,00	<b>0,00</b>
<b>Surcharges seat</b>			
standard seat	01	0,00	<b>0,00</b>
Contour seat (only for mechanism with seat depth adjustment)	02	616,00	<b>770,00</b>
Formfit F seat (only for mechanism with seat depth adjustment / in Plano, Silk Mesh or Reflect)	03	616,00	<b>770,00</b>
<b>Surcharges armrests</b>			
without armrests	21	0,00	<b>0,00</b>
2D armrests F, polished aluminium	23	1.488,00	<b>1.860,00</b>
2D armrests F, powder-coated aluminium	24	1.488,00	<b>1.860,00</b>
3D armrests F, polished aluminium	25	2.136,00	<b>2.670,00</b>
3D armrests F, powder-coated aluminium	29	2.136,00	<b>2.670,00</b>
ring armrests, polished aluminium	27	2.136,00	<b>2.670,00</b>
ring armrests, powder-coated aluminium	28	2.136,00	<b>2.670,00</b>
<b>Surcharges base</b>			
five-star base, plastic, basic dark	31	0,00	<b>0,00</b>
five-star base, polished aluminium	32	1.592,00	<b>1.990,00</b>
five-star base, powder-coated aluminium	30	1.592,00	<b>1.990,00</b>
four-star base, polished aluminium (only for FlowMotion conference)	33	1.592,00	<b>1.990,00</b>
four-star base, powder-coated aluminium	34	1.592,00	<b>1.990,00</b>

Fabric F30	Fabric F40	Fabric F60	Backrest colour ID Air	Frame	Castors/Glides
Plano	Laser RE Reflect	Volo	30 basic dark 53 soft grey	30 basic dark 53 soft grey	02 castors hard, braked for carpet 03 castors soft, braked for hard floor 04 glides for carpet 05 felt glides for hard floor

## ID Mesh

Antonio Citterio, 2010/2021

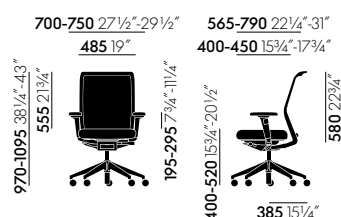

ID Mesh with 2D armrests

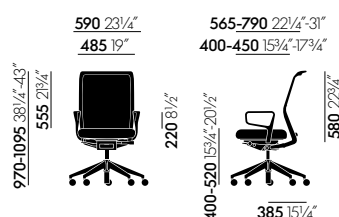

ID Mesh with ring armrests

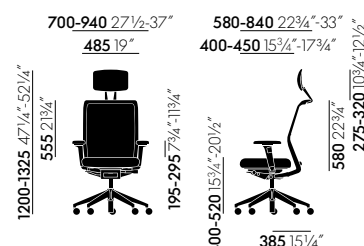

ID Mesh with 3D armrests and headrest

All measurements are pursuant to EN 1335-1:2000

More detailed information is found in the chapter 'Explanation of measurements'.

Office swivel chair with 2D or 3D armrests in accordance with EN 1335, Ergonomic Seal of Approval (LGA Nuremberg). The version equipped with the FlowMotion mechanism with forward tilt and seat depth adjustment complies with BS 5459-2 (24-hour test).

**Seat mechanism:** FlowMotion mechanism, lockable in upright sitting position. Seat mechanism matches the frame colour (basic dark or soft grey). Optionally with or without synchronous forward tilt (can be disabled) or seat depth adjustment. Individual adjustment of backrest resistance and forward tilt.

**Backrest:** frame in polyamide (basic dark or soft grey). With height-adjustable lumbar support. Backrest cover in Diamond Mesh 3D spacer fabric (mesh look) or Silk Mesh (solid look). For Silk Mesh in the colour soft grey, the reverse side is in soft grey. For Silk Mesh in the colours nero and asphalt, the reverse side is in nero. For Silk Mesh in the colours olive green, smoke blue and dim grey, the reverse side matches the frame colour (soft grey or nero).

**Armrests:** 2D armrests with adjustable height and width or 3D armrests with adjustable height, width and depth and 360° swivel function. Armrest supports in aluminium, polished or powder-coated in the colours basic dark or soft grey (to match the frame colour). Armrest sleeves in polyamide are matched to the frame colour (basic dark or soft grey). With PU-foam-free (F) pads in basic dark (for frame colour basic dark) or dim grey (for frame colour soft grey). Optionally available with ring armrests for use in conference settings, made of die-cast aluminium, polished or powder-coated in basic dark or soft grey (to match the frame colour).

**Seat:** polyurethane foam padding. Optional contour seat or PU-foam-free formfit (F) seat. Seat cover in woven fabric or 3D spacer fabric.

**Base:** five-star base in polyamide (basic dark) or die-cast aluminium, polished or powder-coated in basic dark or soft grey (to match the frame colour), with double castors (Ø 60 mm) or glides.

**Accessories:** headrest in polyamide (basic dark or soft grey) with adjustable angle and height, retrofit option. With polyurethane pad in basic dark (for headrest in basic dark) or dim grey (for headrest in soft grey). Clothes hanger in polyamide (basic dark or soft grey), retrofit option (max. weight load: 2 kg). Headrest and clothes hanger can be used separately or combined.

**Conference version:** conference chair (swivel) with four-star base made of die-cast aluminium, polished or powder-coated in basic dark or soft grey (to match frame colour) on glides in accordance with EN 16139. FlowMotion conference mechanism (no forward tilt, no seat depth adjustment) with individual adjustment of backrest resistance; fixed seat height with shock-absorbing seat suspension for added comfort.

Fabric F30	Fabric F40	Fabric F60	Frame	Castors/Glides
Plano	Laser RE Reflect	Volo	30 basic dark 53 soft grey	02 castors hard, braked for carpet 03 castors soft, braked for hard floor 04 glides for carpet 05 felt glides for hard floor

# ID Mesh

Antonio Citterio, 2010/2021

vitra.



ID Mesh	Article no.	without VAT in SEK*	with VAT in SEK*
	<b>431 401 00</b>		
Backrest Diamond Mesh, seat Silk Mesh		6.712,00	<b>8.390,00</b>
Backrest Diamond Mesh, seat fabric F30		6.712,00	<b>8.390,00</b>
Backrest Diamond Mesh, seat fabric F40		6.824,00	<b>8.530,00</b>
Backrest Diamond Mesh, seat fabric F60		7.112,00	<b>8.890,00</b>
Seat and backrest Silk Mesh		6.712,00	<b>8.390,00</b>
Backrest Silk Mesh, seat fabric F30		6.712,00	<b>8.390,00</b>
Backrest Silk Mesh, seat fabric F40		6.824,00	<b>8.530,00</b>
Backrest Silk Mesh, seat fabric F60		7.112,00	<b>8.890,00</b>
<b>Surcharges mechanical elements</b>			
FlowMotion without forward tilt, without seat depth adjustment	11	0,00	<b>0,00</b>
FlowMotion without forward tilt, with seat depth adjustment	13	560,00	<b>700,00</b>
FlowMotion with forward tilt, with seat depth adjustment	14	1.176,00	<b>1.470,00</b>
FlowMotion conference mechanism	17	0,00	<b>0,00</b>
<b>Surcharges seat</b>			
standard seat	01	0,00	<b>0,00</b>
Contour seat (only for mechanism with seat depth adjustment)	02	616,00	<b>770,00</b>
Formfit F seat (only for mechanism with seat depth adjustment / in Plano, Silk Mesh or Reflect)	03	616,00	<b>770,00</b>
<b>Surcharges armrests</b>			
without armrests	21	0,00	<b>0,00</b>
2D armrests F, polished aluminium	23	1.488,00	<b>1.860,00</b>
2D armrests F, powder-coated aluminium	24	1.488,00	<b>1.860,00</b>
3D armrests F, polished aluminium	25	2.136,00	<b>2.670,00</b>
3D armrests F, powder-coated aluminium	29	2.136,00	<b>2.670,00</b>
ring armrests, polished aluminium	27	2.136,00	<b>2.670,00</b>
ring armrests, powder-coated aluminium	28	2.136,00	<b>2.670,00</b>
<b>Surcharges base</b>			
five-star base, plastic, basic dark	31	0,00	<b>0,00</b>
five-star base, polished aluminium	32	1.592,00	<b>1.990,00</b>
five-star base, powder-coated aluminium	30	1.592,00	<b>1.990,00</b>
four-star base, polished aluminium (only for FlowMotion conference)	33	1.592,00	<b>1.990,00</b>
four-star base, powder-coated aluminium	34	1.592,00	<b>1.990,00</b>

Accessory	Article no.	without VAT in SEK*	with VAT in SEK*
<b>Headrest</b>	<b>431 000 00</b>		
		1.168,00	<b>1.460,00</b>
<b>Clothes hanger</b>	<b>431 010 00</b>		
		560,00	<b>700,00</b>
<b>Set of headrest and clothes hanger</b>	<b>431 020 00</b>		
		1.728,00	<b>2.160,00</b>



ID Mesh, seat cover in Plano nero, back cover in Diamond Mesh nero	Article no.	without VAT in SEK*	with VAT in SEK*
<b>Hard braked castors for carpet</b>	<b>QS3 140 1A</b>	9.376,00	<b>11.720,00</b>
<b>Soft braked castors for hard floors</b>	<b>QS3 140 1B</b>	9.376,00	<b>11.720,00</b>

## ID Soft

Antonio Citterio, 2010/2021



ID Soft with 3D armrests

ID Soft with 3D armrests

ID Soft with 2D armrests

All measurements are pursuant to EN 1335-1:2000

More detailed information is found in the chapter 'Explanation of measurements'.

**Office swivel chair with 2D or 3D armrests in accordance with EN 1335, Ergonomic Seal of Approval (LGA Nuremberg). The version equipped with the FlowMotion mechanism with forward tilt and seat depth adjustment complies with BS 5459-2 (24-hour test).**

**Seat mechanism:** FlowMotion mechanism, lockable in upright sitting position. Seat mechanism matches the frame colour (basic dark or soft grey). Optionally with or without synchronous forward tilt (can be disabled) or seat depth adjustment. Individual adjustment of backrest resistance and forward tilt.

**Backrest:** height-adjustable backrest in polyamide (basic dark or soft grey) with padded cushion in polyurethane foam. Cover in fabric, in Striped Knit or in 3D spacer fabric.

**Armrests:** 2D armrests with adjustable height and width or 3D armrests with adjustable height, width and depth and 360° swivel function. Armrest supports in aluminium, polished or powder-coated in the colours basic dark or soft grey (to match the frame colour). Armrest sleeves in polyamide are matched to the frame colour (basic dark or soft grey). With PU-foam-free (F) pads in basic dark (for frame colour basic dark) or dim grey (for frame colour soft grey). Optionally available with ring armrests for use in conference settings, made of die-cast aluminium, polished or powder-coated in basic dark or soft grey (to match the frame colour).

**Seat:** polyurethane foam padding. Optionally available with contoured seat. Seat cover in woven fabric or 3D spacer fabric.

**Base:** five-star base in polyamide (basic dark) or die-cast aluminium, polished or powder-coated in basic dark or soft grey (to match the frame colour), with double castors (Ø 60 mm) or glides.

**Conference version:** conference chair (swivel) with four-star base made of die-cast aluminium, polished or powder-coated in basic dark or soft grey (to match frame colour) on glides in accordance with EN 16139. FlowMotion conference mechanism (no forward tilt, no seat depth adjustment) with individual adjustment of backrest resistance; fixed seat height with shock-absorbing seat suspension for added comfort.



ID Soft	Article no.	without VAT in SEK*	with VAT in SEK*
	<b>431 402 00</b>		
Backrest and seat Silk Mesh		7.696,00	<b>9.620,00</b>
Backrest and seat fabric F30		7.696,00	<b>9.620,00</b>
Backrest and seat fabric F40		7.912,00	<b>9.890,00</b>
Backrest and seat fabric F60		8.544,00	<b>10.680,00</b>
Backrest Striped Knit, seat Silk Mesh		8.432,00	<b>10.540,00</b>
Backrest Striped Knit, seat fabric F30		8.432,00	<b>10.540,00</b>
Backrest Striped Knit, seat fabric F40		8.552,00	<b>10.690,00</b>
Backrest Striped Knit, seat fabric F60		8.840,00	<b>11.050,00</b>
<b>Surcharges mechanical elements</b>			
FlowMotion without forward tilt, without seat depth adjustment	11	0,00	<b>0,00</b>
FlowMotion without forward tilt, with seat depth adjustment	13	560,00	<b>700,00</b>
FlowMotion with forward tilt, with seat depth adjustment	14	1.176,00	<b>1.470,00</b>
FlowMotion conference mechanism	17	0,00	<b>0,00</b>
<b>Surcharges seat</b>			
standard seat	01	0,00	<b>0,00</b>
contour seat (only for mechanism with seat depth adjustment)	02	616,00	<b>770,00</b>
<b>Surcharges armrests</b>			
without armrests	21	0,00	<b>0,00</b>
2D armrests F, polished aluminium	23	1.488,00	<b>1.860,00</b>
2D armrests F, powder-coated aluminium	24	1.488,00	<b>1.860,00</b>
3D armrests F, polished aluminium	25	2.136,00	<b>2.670,00</b>
3D armrests F, powder-coated aluminium	29	2.136,00	<b>2.670,00</b>
ring armrests, polished aluminium	27	2.136,00	<b>2.670,00</b>
ring armrests, powder-coated aluminium	28	2.136,00	<b>2.670,00</b>
<b>Surcharges base</b>			
five-star base, plastic, basic dark	31	0,00	<b>0,00</b>
five-star base, polished aluminium	32	1.592,00	<b>1.990,00</b>
five-star base, powder-coated aluminium	30	1.592,00	<b>1.990,00</b>
four-star base, polished aluminium (only for FlowMotion conference)	33	1.592,00	<b>1.990,00</b>
four-star base, powder-coated aluminium	34	1.592,00	<b>1.990,00</b>



ID Soft, seat and backrest covers in Plano nero	Article no.	without VAT in SEK*	with VAT in SEK*
<b>Hard braked castors for carpet</b>	<b>QS3 140 2A</b>	10.360,00	<b>12.950,00</b>
			FlowMotion mechanism with forward tilt and seat depth adjustment; frame in colour basic dark; 2D armrests F, polished aluminium; five-star base in plastic, basic dark
<b>Soft braked castors for hard floors</b>	<b>QS3 140 2B</b>	10.360,00	<b>12.950,00</b>
			FlowMotion mechanism with forward tilt and seat depth adjustment; frame in colour basic dark; 2D armrests F, polished aluminium; five-star base in plastic, basic dark

Fabric F30	Fabric F40	Fabric F60	Frame	Castors/Glides
Plano	Laser RE Reflect	Volo	30 basic dark 53 soft grey	02 castors hard, braked for carpet 03 castors soft, braked for hard floor 04 glides for carpet 05 felt glides for hard floor

## ID Soft L

Antonio Citterio, 2016/2021



All measurements are pursuant to EN 1335-1:2000

More detailed information is found in the chapter 'Explanation of measurements'.

**Office swivel chair with 2D or 3D armrests in accordance with EN 1335, Ergonomic Seal of Approval (LGA Nuremberg).**

**Seat mechanism:** FlowMotion mechanism, lockable in upright sitting position. Seat mechanism matches the frame colour (basic dark or soft grey). Optionally with or without synchronous forward tilt (can be disabled) or seat depth adjustment. Individual adjustment of backrest resistance and forward tilt.

**Backrest:** height-adjustable high backrest in polyamide (basic dark or soft grey) with padded cushion in polyurethane foam. Seat cover in woven fabric or 3D spacer fabric.

**Armrests:** 2D armrests with adjustable height and width or 3D armrests with adjustable height, width and depth and 360° swivel function. Armrest supports in aluminium, polished or powder-coated in the colours basic dark or soft grey (to match the frame colour). Armrest sleeves in polyamide are matched to the frame colour (basic dark or soft grey). With PU-foam-free (F) pads in basic dark (for frame colour basic dark) or dim grey (for frame colour soft grey). Optionally available with ring armrests for use in conference settings, made of die-cast aluminium, polished or powder-coated in basic dark or soft grey (to match the frame colour).

**Seat:** polyurethane foam padding. Optionally available with contoured seat. Seat and back covers in woven fabric or 3D spacer fabric.

**Base:** five-star base in polyamide (basic dark) or die-cast aluminium, polished or powder-coated in basic dark or soft grey (to match the frame colour), with double castors (Ø 60 mm) or glides.

**Accessories:** clothes hanger in polyamide (basic dark or soft grey), max. weight load: 2 kg.

**Conference version:** conference chair (swivel) with four-star base made of die-cast aluminium, polished or powder-coated in basic dark or soft grey (to match frame colour) on glides in accordance with EN 16139. FlowMotion conference mechanism (no forward tilt, no seat depth adjustment) with individual adjustment of backrest resistance; fixed seat height with shock-absorbing seat suspension for added comfort.

# ID Soft L

Antonio Citterio, 2016/2021

vitra.



ID Soft L	Article no.	without VAT in SEK*	with VAT in SEK*
	<b>431 408 00</b>		
Backrest and seat Silk Mesh		8.848,00	<b>11.060,00</b>
Backrest and seat fabric F30		8.848,00	<b>11.060,00</b>
Backrest and seat fabric F40		9.192,00	<b>11.490,00</b>
Backrest and seat fabric F60		10.064,00	<b>12.580,00</b>
<b>Surcharges mechanical elements</b>			
FlowMotion without forward tilt, without seat depth adjustment	11	0,00	<b>0,00</b>
FlowMotion without forward tilt, with seat depth adjustment	13	560,00	<b>700,00</b>
FlowMotion with forward tilt, with seat depth adjustment	14	1.176,00	<b>1.470,00</b>
FlowMotion conference mechanism	17	0,00	<b>0,00</b>
<b>Surcharges seat</b>			
standard seat	01	0,00	<b>0,00</b>
contour seat (only for mechanism with seat depth adjustment)	02	616,00	<b>770,00</b>
<b>Surcharges armrests</b>			
without armrests	21	0,00	<b>0,00</b>
2D armrests F, polished aluminium	23	1.488,00	<b>1.860,00</b>
2D armrests F, powder-coated aluminium	24	1.488,00	<b>1.860,00</b>
3D armrests F, polished aluminium	25	2.136,00	<b>2.670,00</b>
3D armrests F, powder-coated aluminium	29	2.136,00	<b>2.670,00</b>
ring armrests, polished aluminium	27	2.136,00	<b>2.670,00</b>
ring armrests, powder-coated aluminium	28	2.136,00	<b>2.670,00</b>
<b>Surcharges base</b>			
five-star base, plastic, basic dark	31	0,00	<b>0,00</b>
five-star base, polished aluminium	32	1.592,00	<b>1.990,00</b>
five-star base, powder-coated aluminium	30	1.592,00	<b>1.990,00</b>
four-star base, polished aluminium (only for FlowMotion conference)	33	1.592,00	<b>1.990,00</b>
four-star base, powder-coated aluminium	34	1.592,00	<b>1.990,00</b>
<b>Accessories</b>			
clothes hanger (mounted on chair)	42	944,00	<b>1.180,00</b>

Fabric F30	Fabric F40	Fabric F60	Frame	Castors/Glides
Plano	Laser RE Reflect	Volo	30 basic dark 53 soft grey	02 castors hard, braked for carpet 03 castors soft, braked for hard floor 04 glides for carpet 05 felt glides for hard floor

## ID Trim

Antonio Citterio, 2010/2021

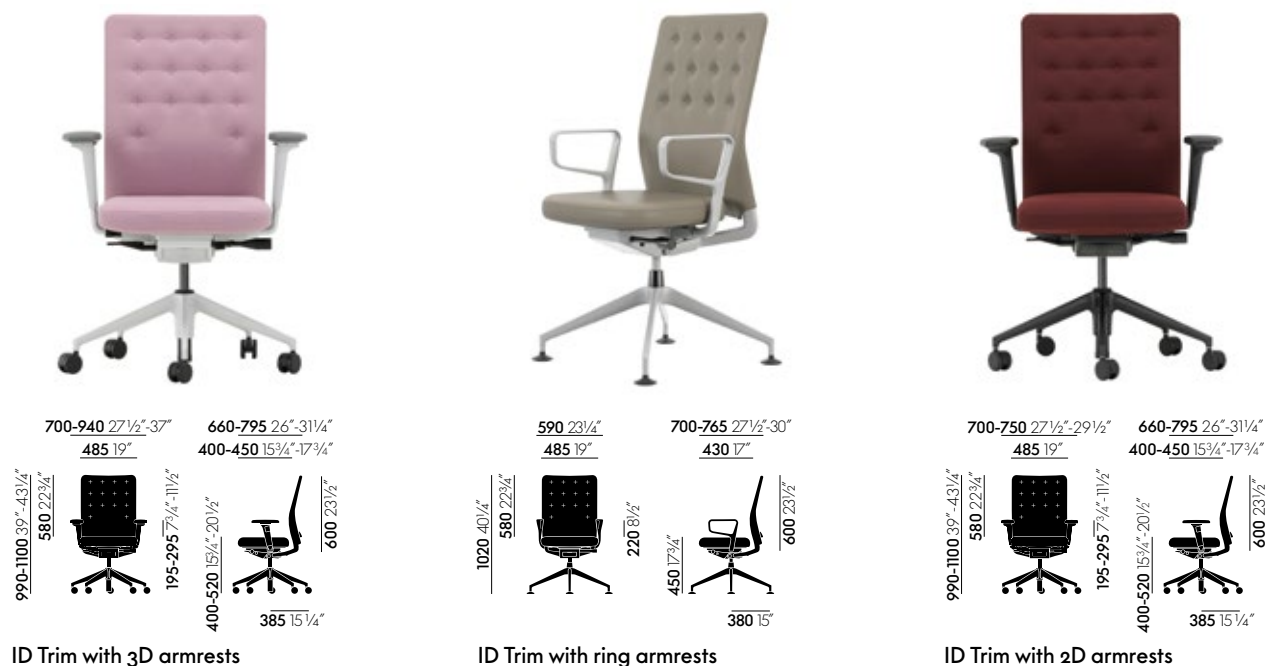

All measurements are pursuant to EN 1335-1:2000

More detailed information is found in the chapter 'Explanation of measurements'.

**Office swivel chair with 2D or 3D armrests in accordance with EN 1335, Ergonomic Seal of Approval (LGA Nuremberg). The version equipped with the FlowMotion mechanism with forward tilt and seat depth adjustment complies with BS 5459-2 (24-hour test).**

**Seat mechanism:** FlowMotion mechanism, lockable in upright sitting position. Seat mechanism matches the frame colour (basic dark or soft grey). Optionally with or without synchronous forward tilt (can be disabled) or seat depth adjustment. Individual adjustment of backrest resistance and forward tilt.

**Backrest:** frame in polyamide (basic dark or soft grey). Optional height-adjustable lumbar cushion. Cover in fabric or leather.

**Armrests:** 2D armrests with adjustable height and width or 3D armrests with adjustable height, width and depth and 360° swivel function. Armrest supports in aluminium, polished or powder-coated in the colours basic dark or soft grey (to match the frame colour). Armrest sleeves in polyamide are matched to the frame colour (basic dark or soft grey). With PU-foam-free (F) pads in basic dark (for frame colour basic dark) or dim grey (for frame colour soft grey). Optionally available with ring armrests for use in conference settings, made of die-cast aluminium, polished or powder-coated in basic dark or soft grey (to match the frame colour).

**Seat:** polyurethane foam padding. Optionally available with contoured seat. Seat and back covers in fabric or leather. Leather covers are not recommended for chairs with forward tilt, since a leather surface might cause users to slide off the seat.

**Base:** five-star base in polyamide (basic dark) or die-cast aluminium, polished or powder-coated in basic dark or soft grey (to match the frame colour), with double castors (Ø 60 mm) or glides.

**Accessories:** clothes hanger in polyamide (basic dark or soft grey), max. weight load: 2 kg.

**Conference version:** conference chair (swivel) with four-star base made of die-cast aluminium, polished or powder-coated in basic dark or soft grey (to match frame colour) on glides in accordance with EN 16139. FlowMotion conference mechanism (no forward tilt, no seat depth adjustment) with individual adjustment of backrest resistance; fixed seat height with shock-absorbing seat suspension for added comfort.



# ID Trim

Antonio Citterio, 2010/2021

vitra.



ID Trim	Article no.	without VAT in SEK*	with VAT in SEK*
	<b>431 403 00</b>		
Backrest and seat fabric F30		8.008,00	<b>10.010,00</b>
Backrest and seat fabric F40		8.224,00	<b>10.280,00</b>
Backrest and seat fabric F60		9.056,00	<b>11.320,00</b>
Backrest and seat leather L20		17.016,00	<b>21.270,00</b>
<b>Surcharges mechanical elements</b>			
without adjustable lumbar support	51	0,00	<b>0,00</b>
with adjustable lumbar support	52	536,00	<b>670,00</b>
<b>Surcharges mechanical elements</b>			
FlowMotion without forward tilt, without seat depth adjustment	11	0,00	<b>0,00</b>
FlowMotion without forward tilt, with seat depth adjustment	13	560,00	<b>700,00</b>
FlowMotion with forward tilt, with seat depth adjustment	14	1.176,00	<b>1.470,00</b>
FlowMotion conference mechanism	17	0,00	<b>0,00</b>
<b>Surcharges seat</b>			
standard seat	01	0,00	<b>0,00</b>
contour seat (only for mechanism with seat depth adjustment)	02	616,00	<b>770,00</b>
<b>Surcharges armrests</b>			
without armrests	21	0,00	<b>0,00</b>
2D armrests F, polished aluminium	23	1.488,00	<b>1.860,00</b>
2D armrests F, powder-coated aluminium	24	1.488,00	<b>1.860,00</b>
3D armrests F, polished aluminium	25	2.136,00	<b>2.670,00</b>
3D armrests F, powder-coated aluminium	29	2.136,00	<b>2.670,00</b>
ring armrests, polished aluminium	27	2.136,00	<b>2.670,00</b>
ring armrests, powder-coated aluminium	28	2.136,00	<b>2.670,00</b>
<b>Surcharges base</b>			
five-star base, plastic, basic dark	31	0,00	<b>0,00</b>
five-star base, polished aluminium	32	1.592,00	<b>1.990,00</b>
five-star base, powder-coated aluminium	30	1.592,00	<b>1.990,00</b>
four-star base, polished aluminium (only for FlowMotion conference)	33	1.592,00	<b>1.990,00</b>
four-star base, powder-coated aluminium	34	1.592,00	<b>1.990,00</b>
<b>Accessories</b>			
clothes hanger (mounted on chair)	42	912,00	<b>1.140,00</b>

Fabric F30	Fabric F40	Fabric F60	Leather L20	Frame	Castors/Glides
Plano	Laser RE Reflect	Volo	Leather	30 basic dark 53 soft grey	02 castors hard, braked for carpet 03 castors soft, braked for hard floor 04 glides for carpet 05 felt glides for hard floor

## ID Trim L

Antonio Citterio, 2010/2021



ID Trim L with 3D armrests and clothes hanger

ID Trim L with ring armrests

ID Trim L with ring armrests

All measurements are pursuant to EN 1335-1:2000  
 More detailed information is found in the chapter 'Explanation of measurements'.

Office swivel chair with 2D or 3D armrests in accordance with EN 1335, Ergonomic Seal of Approval (LGA Nuremberg). The version equipped with the FlowMotion mechanism with forward tilt and seat depth adjustment complies with BS 5459-2 (24-hour test).

**Seat mechanism:** FlowMotion mechanism, lockable in upright sitting position. Seat mechanism matches the frame colour (basic dark or soft grey). Optionally with or without synchronous forward tilt (can be disabled) or seat depth adjustment. Individual adjustment of backrest resistance and forward tilt.

**Backrest:** high backrest with integrated, height-adjustable headrest. Backrest frame in polyamide (basic dark or soft grey). Optional height-adjustable lumbar cushion. Cover in fabric or leather. Headrest for leather upholstery in the corresponding leather colour; for fabric upholstery, headrest covered in dim grey leather or nero leather.

**Armrests:** 2D armrests with adjustable height and width or 3D armrests with adjustable height, width and depth and 360° swivel function. Armrest supports in aluminium, polished or powder-coated in the colours basic dark or soft grey (to match the frame colour). Armrest sleeves in polyamide are matched to the frame colour (basic dark or soft grey). With PU-foam-free (F) pads in basic dark (for frame colour basic dark) or dim grey (for frame colour soft grey). Optionally available with ring armrests for use in conference settings, made of die-cast aluminium, polished or powder-coated in basic dark or soft grey (to match the frame colour).

**Seat:** polyurethane foam padding. Optionally available with contoured seat. Seat and back covers in fabric or leather. Leather covers are not recommended for chairs with forward tilt, since a leather surface might cause users to slide off the seat.

**Base:** five-star base in polyamide (basic dark) or die-cast aluminium, polished or powder-coated in basic dark or soft grey (to match the frame colour), with double castors (Ø 60 mm) or glides.

**Accessories:** clothes hanger in polyamide (basic dark or soft grey), max. weight load: 2 kg.

**Conference version:** conference chair (swivel) with four-star base made of die-cast aluminium, polished or powder-coated in basic dark or soft grey (to match frame colour) on glides in accordance with EN 16139. FlowMotion conference mechanism (no forward tilt, no seat depth adjustment) with individual adjustment of backrest resistance; fixed seat height with shock-absorbing seat suspension for added comfort.

# ID Trim L

Antonio Citterio, 2010/2021



ID Trim L	Article no.	without VAT in SEK*	with VAT in SEK*
	<b>431 404 00</b>		
Backrest and seat fabric F30		9.096,00	<b>11.370,00</b>
Backrest and seat fabric F40		9.296,00	<b>11.620,00</b>
Backrest and seat fabric F60		10.248,00	<b>12.810,00</b>
Backrest and seat leather L20		18.544,00	<b>23.180,00</b>
<b>Surcharges lumbar support</b>			
without adjustable lumbar support	51	0,00	<b>0,00</b>
with adjustable lumbar support	52	536,00	<b>670,00</b>
<b>Surcharges mechanical elements</b>			
FlowMotion without forward tilt, without seat depth adjustment	11	0,00	<b>0,00</b>
FlowMotion without forward tilt, with seat depth adjustment	13	560,00	<b>700,00</b>
FlowMotion with forward tilt, with seat depth adjustment	14	1.176,00	<b>1.470,00</b>
FlowMotion conference mechanism	17	0,00	<b>0,00</b>
<b>Surcharges seat</b>			
standard seat	01	0,00	<b>0,00</b>
contour seat (only for mechanism with seat depth adjustment)	02	616,00	<b>770,00</b>
<b>Surcharges armrests</b>			
without armrests	21	0,00	<b>0,00</b>
2D armrests F, polished aluminium	23	1.488,00	<b>1.860,00</b>
2D armrests F, powder-coated aluminium	24	1.488,00	<b>1.860,00</b>
3D armrests F, polished aluminium	25	2.136,00	<b>2.670,00</b>
3D armrests F, powder-coated aluminium	29	2.136,00	<b>2.670,00</b>
ring armrests, polished aluminium	27	2.136,00	<b>2.670,00</b>
ring armrests, powder-coated aluminium	28	2.136,00	<b>2.670,00</b>
<b>Surcharges base</b>			
five-star base, plastic, basic dark	31	0,00	<b>0,00</b>
five-star base, polished aluminium	32	1.592,00	<b>1.990,00</b>
five-star base, powder-coated aluminium	30	1.592,00	<b>1.990,00</b>
four-star base, polished aluminium (only for FlowMotion conference)	33	1.592,00	<b>1.990,00</b>
four-star base, powder-coated aluminium	34	1.592,00	<b>1.990,00</b>
<b>Accessories</b>			
clothes hanger (mounted on chair)	42	912,00	<b>1.140,00</b>

Fabric F30	Fabric F40	Fabric F60	Leather L20	Headrest, leather (with fabric cover)	Frame	Castors/Glides
Plano	Laser RE Reflect	Volo	Leather	21 dim grey 66 nero	30 basic dark 53 soft grey	02 castors hard, braked for carpet 03 castors soft, braked for hard floor 04 glides for carpet 05 felt glides for hard floor

# Lobby Chair

Charles & Ray Eames, 1960

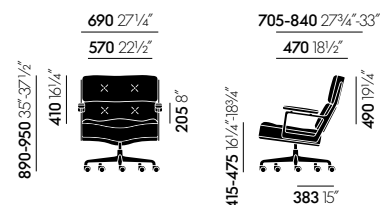

## ES 104

All measurements are pursuant to EN 1335-1:2000  
 More detailed information is found in the chapter 'Explanation of measurements'.

**Seat mechanism:** adjustable backward tilt. Continuous seat height adjustment with gas spring. Swivel seat.

**Backrest and seat:** side frames in chrome-plated die-cast aluminium. Cushion elements covered in leather.

**Armrests:** upholstered in leather.

**Base:** five-star base in chrome-plated die-cast aluminium, on castors. Equipped with hard castors for carpet or soft castors for hard floors.

**Options:** also available as a conference chair equipped with glides or in a wider version especially suited for waiting areas.

## ES 104

	Article no.	without VAT in SEK*	with VAT in SEK*
<b>swivel</b>	<b>412 207 00</b>		
with armrests			
Leather L20		68.400,00	<b>85.500,00</b>
Leather L50		73.600,00	<b>92.000,00</b>

### Leather L20

Leather

### Leather L50

Leather Premium F

### Castors

02 castors hard, braked for carpet  
 03 castors soft, braked for hard floor

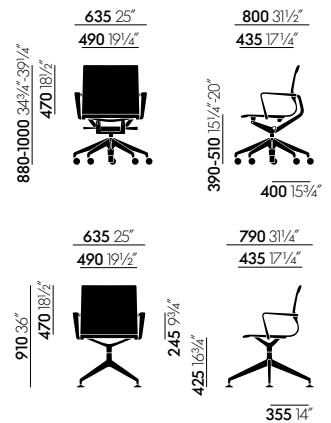

All measurements are pursuant to EN 1335-1:2000  
More detailed information is found in the chapter 'Explanation of measurements'.

**Office swivel chair in accordance with EN 1335.**

**Mechanical unit and back braces:** powder-coated aluminium in deep black (RAL 9005) or soft grey (RAL 7047). With synchronised movement, individual adjustment of backrest resistance and locking device in upright position. Seat height continuously adjustable via gas spring.

**Frame, seat and back:** flexible frame and armrests in polyamide (deep black or soft grey). One-piece sling panel for the seat and back in TrioKnit knitted fabric or FleeceNet woven fabric.

**Base:** five-star base in die-cast aluminium, with a polished finish or powder-coated in deep black or soft grey.

**Conference chair (swivel) in accordance with EN 16139.**

**Frame, seat and back:** flexible frame and armrests in polyamide (deep black or soft grey). One-piece sling panel for the seat and back in TrioKnit knitted fabric or FleeceNet woven fabric.

**Base:** four-star base in die-cast aluminium, with a polished finish or powder-coated in deep black or soft grey.

Physix	Article no.	without VAT in SEK*	with VAT in SEK*
<b>Five-star base</b>	<b>417 210 00</b>		
aluminium base deep black, TrioKnit	01	10.272,00	<b>12.840,00</b>
aluminium base soft grey, TrioKnit	11	10.272,00	<b>12.840,00</b>
aluminium base polished, TrioKnit	21	10.272,00	<b>12.840,00</b>
aluminium base deep black, FleeceNet	03	9.528,00	<b>11.910,00</b>
aluminium base soft grey, FleeceNet	13	9.528,00	<b>11.910,00</b>
aluminium base polished, FleeceNet	23	9.528,00	<b>11.910,00</b>

Physix Conference	Article no.	without VAT in SEK*	with VAT in SEK*
<b>Four-star base</b>	<b>417 211 00</b>		
aluminium base deep black, TrioKnit	01	8.936,00	<b>11.170,00</b>
aluminium base soft grey, TrioKnit	11	8.936,00	<b>11.170,00</b>
aluminium base polished, TrioKnit	21	8.936,00	<b>11.170,00</b>
aluminium base deep black, FleeceNet	03	8.176,00	<b>10.220,00</b>
aluminium base soft grey, FleeceNet	13	8.176,00	<b>10.220,00</b>
aluminium base polished, FleeceNet	23	8.176,00	<b>10.220,00</b>

 Quickship

Physix, cover material TrioKnit, black pearl	Article no.	without VAT in SEK*	with VAT in SEK*
<b>Hard braked castors for carpet</b>	<b>QS1 721 0A</b>	10.272,00	<b>12.840,00</b>
Five-star aluminium base in deep black, frame and mechanical unit in deep black			
<b>Soft braked castors for hard floors</b>	<b>QS1 721 0B</b>	10.272,00	<b>12.840,00</b>
Five-star aluminium base in deep black, frame and mechanical unit in deep black			

 Quickship

Physix, cover material TrioKnit, silver grey	Article no.	without VAT in SEK*	with VAT in SEK*
<b>Hard braked castors for carpet</b>	<b>QS1 721 0E</b>	10.272,00	<b>12.840,00</b>
Five-star aluminium base in soft grey, frame and mechanical unit in soft grey			
<b>Soft braked castors for hard floors</b>	<b>QS1 721 0F</b>	10.272,00	<b>12.840,00</b>
Five-star aluminium base in soft grey, frame and mechanical unit in soft grey			

FleeceNet	TrioKnit	Frame	Castors	Glides
01 black	03 reed	12 deep black	02 castors hard, braked for carpet	04 glides for carpet
03 ice grey	06 black pearl	53 soft grey	03 castors soft, braked for hard floor	05 felt glides for hard floor
07 soft grey	07 silver grey			
08 mid-grey	08 pebble grey			
	09 ice grey			
	10 brick			

# Physix Studio

Alberto Meda, 2017

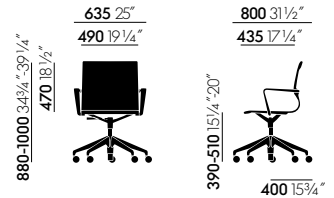

All measurements are pursuant to EN 1335-1:2000  
More detailed information is found in the chapter 'Explanation of measurements'.

## Studio chair (swivel) in accordance with DIN 68877.

**Frame, seat and back:** flexible frame and armrests in polyamide (deep black or soft grey). One-piece sling panel for the seat and back in TrioKnit knitted fabric or FleeceNet woven fabric. Continuous seat height adjustment with gas spring.

**Base:** five-star base in die-cast aluminium, with a polished finish or powder-coated in deep black or soft grey.

## Physix Studio

	Article no.	without VAT in SEK*	with VAT in SEK*
<b>Five-star base</b>		<b>417 212 00</b>	
aluminium base deep black, TrioKnit	01	9.632,00	<b>12.040,00</b>
aluminium base soft grey, TrioKnit	11	9.632,00	<b>12.040,00</b>
aluminium base polished, TrioKnit	21	9.632,00	<b>12.040,00</b>
aluminium base deep black, FleeceNet	03	8.832,00	<b>11.040,00</b>
aluminium base soft grey, FleeceNet	13	8.832,00	<b>11.040,00</b>
aluminium base polished, FleeceNet	23	8.832,00	<b>11.040,00</b>

### FleeceNet

01 black  
03 ice grey  
07 soft grey  
08 mid-grey

### TrioKnit

03 reed  
06 black pearl  
07 silver grey  
08 pebble grey  
09 ice grey  
10 brick

### Frame

12 deep black  
53 soft grey

### Castors

02 castors hard, braked for carpet  
03 castors soft, braked for hard floor

# Pivot

Antonio Citterio, 2012

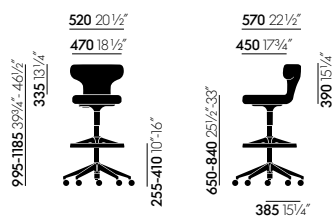

Pivot High Stool

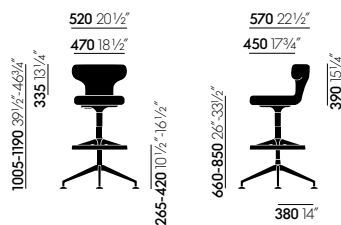

Pivot Counter Stool

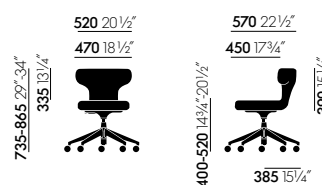

Pivot Stool

All measurements are pursuant to EN 1335-1:2000  
 More detailed information is found in the chapter 'Explanation of measurements'.

**Seat and back shell:** one-piece seat and back shell made of polypropylene and encased in polyurethane foam, covered with SingleKnit fabric.

**Pivot High Stool:** tall task chair in accordance with DIN 68877. Five-star base in polyamide (basic dark) or polished die-cast aluminium with reverse-brake castors. Adjustable seat height. Fitted with height-adjustable polyamide foot ring with anti-skid finish. Adjustment ring for foot ring height is always in the colour soft green.

**Pivot Counter Stool:** tall visitor chair in accordance with EN 16139. Four-star base in polished die-cast aluminium on glides. Adjustable seat height. Also fitted with height-adjustable polyamide foot ring with anti-skid finish. Adjustment ring for foot ring height is always in the colour soft green.

**Pivot Stool:** work chair in accordance with DIN 68877. Without foot ring in normal swivel chair height. Adjustable seat height. Five-star base in polyamide (basic dark) or polished die-cast aluminium, with double castors (Ø 60 mm) or glides.



# Pivot

Antonio Citterio, 2012



<b>Pivot High Stool</b>	Article no.	without VAT in SEK*	with VAT in SEK*
<b>Five-star base</b>	<b>421 010 00</b>		
base plastic basic dark, SingleKnit	01	10.736,00	<b>13.420,00</b>
base polished aluminium, SingleKnit	11	12.408,00	<b>15.510,00</b>

<b>Pivot Counter Stool</b>	Article no.	without VAT in SEK*	with VAT in SEK*
<b>Four-star base</b>	<b>421 011 00</b>		
base polished aluminium, SingleKnit	11	12.408,00	<b>15.510,00</b>

<b>Pivot Stool</b>	Article no.	without VAT in SEK*	with VAT in SEK*
<b>Five-star base</b>	<b>421 012 00</b>		
base plastic basic dark, SingleKnit	01	8.376,00	<b>10.470,00</b>
base polished aluminium, SingleKnit	11	10.048,00	<b>12.560,00</b>

Knit	Castors (Pivot High Stool)	Castors (Pivot Stool)	Glides (Pivot Counter Stool)
. SingleKnit	06 castors inversely braked	02 castors hard, braked for carpet 03 castors soft, braked for hard floor	04 glides for carpet 05 felt glides for hard floor

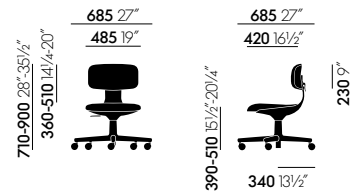

All measurements are pursuant to EN 1335-1:2000  
More detailed information is found in the chapter 'Explanation of measurements'.

### Studio chair (swivel, height-adjustable) in accordance with EN 16139.

**Backrest:** back made of polypropylene and back cushion made of polyurethane foam. Back shell in soft grey or deep black; back cushion with fabric or leather cover stretched over padding. Backrest height adjustable up to 55 mm using a quick release lever.

**Seat:** polypropylene shell in soft grey or deep black; polyurethane foam cushion; fabric or leather cover stretched over padding. Equipped as standard with seat height adjustment.

**Base:** five-star base made of polyamide in soft grey or deep black; double castors (Ø 60 mm) in basic dark.

Rookie	Article no.	without VAT in SEK*	with VAT in SEK*
	<b>419 011 00</b>		
Fabric F30		4.408,00	<b>5.510,00</b>
Fabric F60		4.536,00	<b>5.670,00</b>
Fabric F80		4.688,00	<b>5.860,00</b>
Leather L20		7.984,00	<b>9.980,00</b>



Rookie, cover material Plano, nero	Article no.	without VAT in SEK*	with VAT in SEK*
<b>Hard braked castors for carpet</b>	Shell colour deep black, five-star plastic base in deep black <b>QS1 901 1B</b>	4.408,00	<b>5.510,00</b>
<b>Soft braked castors for hard floors</b>	Shell colour deep black, five-star plastic base in deep black <b>QS1 901 1A</b>	4.408,00	<b>5.510,00</b>



Rookie, cover material Plano, cream white/sierra grey	Article no.	without VAT in SEK*	with VAT in SEK*
<b>Hard braked castors for carpet</b>	Shell colour soft grey, five-star plastic base in soft grey <b>QS1 901 1D</b>	4.408,00	<b>5.510,00</b>
<b>Soft braked castors for hard floors</b>	Shell colour soft grey, five-star plastic base in soft grey <b>QS1 901 1C</b>	4.408,00	<b>5.510,00</b>

Fabric F30	Fabric F60	Fabric F80	Leather L20	Base and frame	Castors
· Plano	· Twill · Volo	· Tress	· Leather	12 deep black 53 soft grey	02 castors hard, braked for carpet 03 castors soft, braked for hard floor

# Rookie High

Konstantin Grcic, 2018

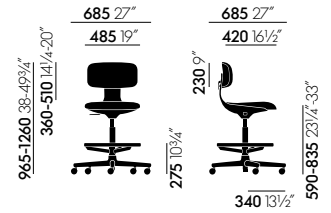

All measurements are pursuant to EN 1335-1:2000  
More detailed information is found in the chapter 'Explanation of measurements'.

## Counter stool in accordance with EN 16139.

**Backrest:** back made of polypropylene and back cushion of polyurethane foam. Back shell in soft grey or deep black; back cushion with fabric or leather cover stretched over padding. Backrest height adjustable up to 55 mm using a quick release lever.

**Seat:** polypropylene shell in soft grey or deep black; polyurethane foam cushion; fabric or leather cover stretched over padding. Equipped as standard with seat height adjustment.

**Foot ring:** equipped with height-adjustable steel foot ring, powder-coated in deep black with anti-skid finish, or chrome-plated.

**Base:** five-star base made of polyamide in soft grey or deep black; reverse brake castors (Ø 60 mm) in basic dark.

## Rookie High

	Article no.	without VAT in SEK*	with VAT in SEK*
	<b>419 012 00</b>		
Fabric F30		7.832,00	<b>9.790,00</b>
Fabric F60		7.976,00	<b>9.970,00</b>
Fabric F80		8.120,00	<b>10.150,00</b>
Leather L20		11.416,00	<b>14.270,00</b>
<b>Footrest</b>			
powder-coated in deep black	1	0,00	<b>0,00</b>
chromed	2	760,00	<b>950,00</b>

Fabric F30	Fabric F60	Fabric F80	Leather L20	Base and frame	Castors
. Plano	. Twill . Volo	. Tress	. Leather	12 deep black 53 soft grey	06 castors inversely braked

# Softshell Chair

Ronan & Erwan Bouroullec, 2008

**vitra.**

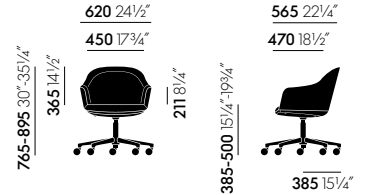

All measurements are pursuant to EN 1335-1:2000  
More detailed information is found in the chapter 'Explanation of measurements'.

**Backrest and seat:** flexible upper backrest shell. Seat and backrest shell in fibreglass-reinforced polyamide. Seat and backrest upholstery in polyurethane foam. Armrests are integrated in the seat shell. With two seams along the sides of the backrest.

**Five-star base:** powder-coated (basic dark) or polished aluminium.

## Softshell Chair

	Article no.	without VAT in SEK*	with VAT in SEK*
<b>Five-star base</b>	<b>423 008 00</b>		
Fabric F30		10.080,00	<b>12.600,00</b>
Fabric F40		10.240,00	<b>12.800,00</b>
Fabric F60		10.720,00	<b>13.400,00</b>
Fabric F80		11.280,00	<b>14.100,00</b>
Fabric F100		12.000,00	<b>15.000,00</b>
Fabric F120		12.560,00	<b>15.700,00</b>
Leather L20		17.680,00	<b>22.100,00</b>
Leather L50		21.440,00	<b>26.800,00</b>
<b>Surcharges base</b>			
aluminium base, powder-coated in basic dark	2	0,00	<b>0,00</b>
aluminium base, polished	3	456,00	<b>570,00</b>

Fabric F30	Fabric F40	Fabric F60	Fabric F80	Fabric F100	Fabric F120	Leather L20	Leather L50	Castors
Plano	Laser RE	Twill Volo	Dumet Linho Tress	Aura Reed	Credo	Leather	Leather Premium F	02 castors hard, braked for carpet 03 castors soft, braked for hard floor

# Unix Chair

Antonio Citterio, 2010



Four-star base



Five-star base

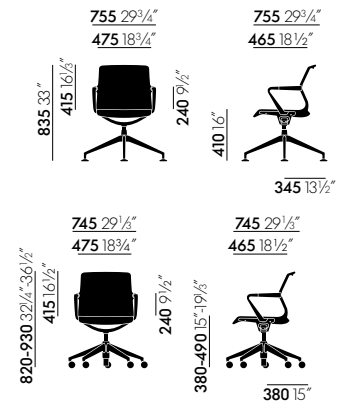

All measurements are pursuant to EN 1335-1:2000  
 More detailed information is found in the chapter 'Explanation of measurements'.

**Seat frame and armrest sleeves:** monochrome polypropylene in basic dark or soft grey.

**Seat and back cover:** Plano fabric or one of the 3D spacer fabrics Diamond Mesh (mesh look) or Silk Mesh (solid look). For Silk Mesh in the colour soft grey, the reverse side is in soft grey. For Silk Mesh in the colours nero and asphalt, the reverse side is in nero. For Silk Mesh in the colours olive green, smoke blue and dim grey, the reverse side matches the frame colour (soft grey or nero).

**Five-star base:** polished die-cast aluminium with double castors (Ø 60 mm). Swivel mechanism, height adjustable.

**Four-star base:** polished die-cast aluminium on glides. Swivel mechanism with vertical spring suspension for added comfort.

## Unix Chair

	Article no.	without VAT in SEK*	with VAT in SEK*
<b>Four-star base</b>	<b>431 205 00</b>		
Silk Mesh		8.576,00	<b>10.720,00</b>
Diamond Mesh		8.576,00	<b>10.720,00</b>
Fabric F30		8.576,00	<b>10.720,00</b>

## Unix Chair

	Article no.	without VAT in SEK*	with VAT in SEK*
<b>Five-star base</b>	<b>431 206 00</b>		
Silk Mesh		9.408,00	<b>11.760,00</b>
Diamond Mesh		9.408,00	<b>11.760,00</b>
Fabric F30		9.408,00	<b>11.760,00</b>

Fabric F30	Frame	Castors/Glides
Plano	30 basic dark 53 soft grey	02 castors hard, braked for carpet 03 castors soft, braked for hard floor 04 glides for carpet 05 felt glides for hard floor

# Chairs



.03  
Maarten Van Severen  
56



.05  
Maarten Van Severen  
58



AC 5 Meet  
Antonio Citterio  
59



EA101/103/104  
Charles & Ray Eames  
61



EA 105/107/108  
Charles & Ray Eames  
63



EA 205/207/208  
Charles & Ray Eames  
65



APC  
Jasper Morrison  
72



Belleville Chair  
R & E Bouroullec  
73



Chaise Tout Bois  
Jean Prouvé  
75



DAR Fiberglass  
Charles & Ray Eames  
76



DAW Fiberglass  
Charles & Ray Eames  
76



DAX Fiberglass  
Charles & Ray Eames  
76



LAR Fiberglass  
Charles & Ray Eames  
78



DSR Fiberglass  
Charles & Ray Eames  
80



DSW Fiberglass  
Charles & Ray Eames  
82



DSX Fiberglass  
Charles & Ray Eames  
84



LSR Fiberglass  
Charles & Ray Eames  
85



DAR  
Charles & Ray Eames  
86



DAW  
Charles & Ray Eames  
86



DAL  
Charles & Ray Eames  
89



DAX  
Charles & Ray Eames  
89



LAR  
Charles & Ray Eames  
92



DSR  
Charles & Ray Eames  
94



DSW  
Charles & Ray Eames  
96



DSX  
Charles & Ray Eames  
98



LSR  
Charles & Ray Eames  
99



DSS  
Charles & Ray Eames  
100



DSS-N  
Charles & Ray Eames  
102



EVO-C  
Jasper Morrison  
104



Fauteuil Direction  
Jean Prouvé  
105



HAL RE Wood  
Jasper Morrison  
106



HAL Ply Wood  
Jasper Morrison  
106



HAL RE Tube  
Jasper Morrison  
108



HAL Ply Tube  
Jasper Morrison  
108



HAL RE Tube Armrest  
Jasper Morrison  
113

Office and conference chairs (swivel)



HAL Tube Writing Tablet  
Jasper Morrison  
113



HAL RE Cantilever  
Jasper Morrison  
115



HAL RE Sledge  
Jasper Morrison  
115

Chairs



Tables



HAL RE Armchair Wood  
Jasper Morrison  
117



HAL RE Armchair Tube  
Jasper Morrison  
117



HAL Soft Wood  
Jasper Morrison  
110

Desks

Public waiting areas



HAL Soft Tube  
Jasper Morrison  
111



HAL Soft Tube Stackable  
Jasper Morrison  
112



HAL RE Stool Medium,  
HAL RE Stool High  
Jasper Morrison  
119

Lounge chairs and armchairs

Sofas



HAL Ply Stool Medium,  
HAL Ply Stool High  
Jasper Morrison  
119



HAL RE Barstool  
Jasper Morrison  
121



ID Visitor Air  
Antonio Citterio  
124

Coffee and side tables

Stools and benches



ID Visitor Mesh  
Antonio Citterio  
124



ID Visitor Soft  
Antonio Citterio  
126



ID Visitor Trim  
Antonio Citterio  
126

Storage and partition elements

Accessories

Living, dining, decorative objects, home office,  
clocks, lighting, publications



Landi Chair  
Hans Coray  
128



Lobby Chair ES 105  
Charles & Ray Eames  
129



Lobby Chair ES 108  
Charles & Ray Eames  
129

Quick Ship programme

General terms, conditions  
and information

## Chairs



Moca  
Jasper Morrison  
130



MedaSlim  
Alberto Meda  
131



Organic Chair  
Charles Eames &  
Eero Saarinen  
133



Organic Conference  
Charles Eames &  
Eero Saarinen  
134



Panton Chair Classic  
Verner Panton  
135



Panton Chair  
Verner Panton  
136



Panton Junior  
Verner Panton  
137



DCM  
Charles & Ray Eames  
138



DCW  
Charles & Ray Eames  
138



Softshell Chair  
R & E Bouroullec  
141



Softshell Side Chair  
R & E Bouroullec  
143



Standard  
Jean Prouvé  
144



Standard SP  
Jean Prouvé  
145



Stool-Tool  
Konstantin Grcic  
146



Tabouret Haut  
Jean Prouvé  
147



Tip Ton  
Barber & Osgerby  
148



Tip Ton RE  
Barber & Osgerby  
149



Unix Chair  
Antonio Citterio  
151



Unix Chair  
Antonio Citterio  
152



Wiggle Side Chair  
Frank Gehry  
153



DKR, DKR-2, DKR-5  
Charles & Ray Eames  
154



DKW, DKW-2, DKW-5  
Charles & Ray Eames  
156



DKX, DKX-2, DKX-5  
Charles & Ray Eames  
157



LKR, LKR-2, LKR-5  
Charles & Ray Eames  
158

## Other products in this chapter

(This chapter presents all of the products belonging to a single product family, regardless of their field of application.)



AC 5 Studio  
Antonio Citterio  
60



EA 117/118/119  
Charles & Ray Eames  
67



EA 217/219  
Charles & Ray Eames  
69



EA 124/125  
Charles & Ray Eames  
70



EA 222/223  
Charles & Ray Eames  
71



RAR Fiberglass  
Charles & Ray Eames  
79



PACC  
Charles & Ray Eames  
91



RAR  
Charles & Ray Eames  
93



PSCC  
Charles & Ray Eames  
103



HAL RE Armchair Studio  
Jasper Morrison  
117



HAL RE Studio  
Jasper Morrison  
117



LCM  
Charles & Ray Eames  
129



Office and conference chairs (swivel)



Chairs

Tables

Desks

Public waiting areas

Lounge chairs and armchairs

Sofas

Coffee and side tables

Stools and benches

Storage and partition elements

Accessories

Living, dining, decorative objects, home office, clocks, lighting, publications

Quick Ship programme

General terms, conditions and information



LCW  
Charles & Ray Eames  
130



Softshell Chair  
R & E Bouroullec  
142



Unix Chair  
Antonio Citterio  
150



Wiggle Stool  
Frank Gehry  
153

.03

Maarten Van Severen, 1998

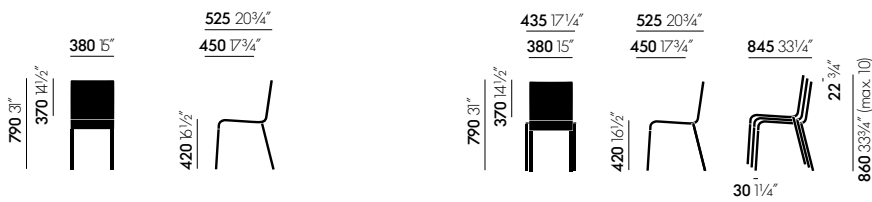

All measurements are pursuant to EN 1335-1:2000  
 More detailed information is found in the chapter 'Explanation of measurements'.

**Seat shell:** integral skin polyurethane foam. Shell with upholstered effect, self-supporting on a tubular steel frame. Flexible backrest with integrated leaf springs.

**Base/stackability:** back legs in tubular steel, front legs in aluminium profile, powder-coated or chrome-plated. Stacking and non-stacking versions. Up to 10 chairs can be stacked on the floor, up to 20 chairs on a stacking trolley. Fitted with plastic glides for carpet or felt glides for hard floors.

## Maarten Van Severen, 1998

.03	Article no.	without VAT in SEK*	with VAT in SEK*
<b>non-stacking</b>	<b>440 426 00</b>		
Base powder-coated in black	55	5.912,00	<b>7.390,00</b>
Base powder-coated in silver, smooth finish	16	5.912,00	<b>7.390,00</b>
Base chrome-plated	01	6.392,00	<b>7.990,00</b>
<b>stacking</b>	<b>440 427 00</b>		
Base powder-coated in black	55	6.160,00	<b>7.700,00</b>
Base powder-coated in silver, smooth finish	16	6.160,00	<b>7.700,00</b>
Base chrome-plated	01	6.600,00	<b>8.250,00</b>

Stacking dolly	Article no.	without VAT in SEK*	with VAT in SEK*
Suitable for up to 20 chairs	<b>442 040 00</b>	12.880,00	<b>16.100,00</b>

End connectors	Article no.	without VAT in SEK*	with VAT in SEK*
plastic basic dark	<b>442 042 00</b>	144,00	<b>180,00</b>

End cap	Article no.	without VAT in SEK*	with VAT in SEK*
Plastic element for numbering the row of chairs	<b>442 043 00</b>	128,00	<b>160,00</b>

Number clips	Article no.	without VAT in SEK*	with VAT in SEK*
Set of 10 items	<b>442 044 00</b>		
	01	176,00	<b>220,00</b>

Seat shell	Glides	Number clips
01 basic dark	04 glides for carpet	01 numbers (1 set 1-10)
10 bright red	05 felt glides for hard floor	02 numbers (1 set 11-20)
77 dark green		03 numbers (1 set 21-30)
78 mango		04 numbers (1 set 31-40)
		05 numbers (1 set 41-50)

# .05

## Maarten Van Severen, 2004

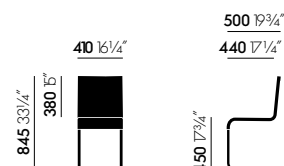

All measurements are pursuant to EN 1335-1:2000  
More detailed information is found in the chapter 'Explanation of measurements'.

**Seat shell:** cantilever chair with seat shell made of integral skin polyurethane foam. Shell with upholstered effect, self-supporting on a tubular stainless steel frame. Flexible backrest with integrated leaf springs.

**Base:** stackable (max. 5 chairs) or non-stackable base in stainless steel with satin finish or powder coating. Fitted with plastic glides for carpet or felt glides for hard floors.

**Use:** suited for outdoor use.

**Note:** special additives retard the fading of colours due to UV radiation. However, if the chair is exposed to sunlight for prolonged periods, the colour may change over time. We recommend limited exposure to sunlight.

.05	Article no.	without VAT in SEK*	with VAT in SEK*
<b>non-stacking</b>	<b>440 121 00</b>		
Base stainless steel, suitable for outdoor use	01	6.920,00	<b>8.650,00</b>
Base powder-coated in black, suitable for outdoor use	55	6.920,00	<b>8.650,00</b>
<b>stacking</b>	<b>440 122 00</b>		
Base stainless steel, suitable for outdoor use	01	7.480,00	<b>9.350,00</b>
Base powder-coated in black, suitable for outdoor use	55	7.480,00	<b>9.350,00</b>

### Seat shell

01 basic dark  
10 bright red  
77 dark green

### Glides

04 glides for carpet  
05 felt glides for hard floor

# AC 5 Meet

Antonio Citterio, 2017

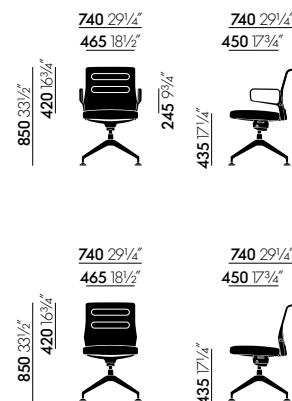

All measurements are pursuant to EN 1335-1:2000  
More detailed information is found in the chapter 'Explanation of measurements'.

## Conference chair (swivel) in accordance with EN 16139.

**Seat mechanism:** tilt mechanism, lockable in upright position. Mechanism housing in polished aluminium.

**Backrest:** self-supporting backrest construction with horizontally stitched padding. Cover in fabric or leather.

**Seat:** polyurethane foam padding. Cover in fabric or leather.

**Armrests:** without armrests or with polished die-cast aluminium ring armrests, optional leather pads (pads are matched to the leather upholstery; for chairs with fabric covers, the leather armrest pads are in the colour nero).

**Base:** four-star base in polished die-cast aluminium on glides. Swivel mount with shock-absorbing seat suspension.

## AC 5 Meet

	Article no.	without VAT in SEK*	with VAT in SEK*
<b>four-star base</b>	<b>421 021 00</b>		
Fabric F30		9.424,00	<b>11.780,00</b>
Fabric F60		9.976,00	<b>12.470,00</b>
Leather L20		16.584,00	<b>20.730,00</b>
<b>Surcharges armrests</b>			
without armrests	11	0,00	<b>0,00</b>
aluminium ring armrests	14	2.224,00	<b>2.780,00</b>
leather-covered aluminium ring armrest	15	3.000,00	<b>3.750,00</b>

Fabric F30	Fabric F60	Leather L20	Glides
. Plano	. Hopsak . Twill	. Leather	04 glides for carpet 05 felt glides for hard floor

# AC 5 Studio

Antonio Citterio, 2017

vitra.

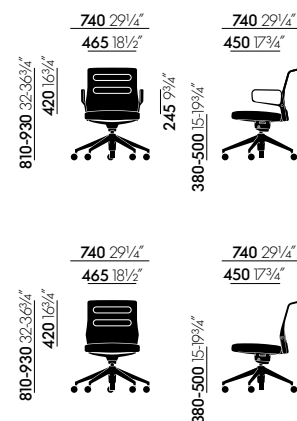

All measurements are pursuant to EN 1335-1:2000  
More detailed information is found in the chapter 'Explanation of measurements'.

**Studio chair (swivel, height-adjustable) in accordance with EN 16139.**

**Seat mechanism:** tilt mechanism, lockable in upright position. Mechanism housing in polished aluminium.

**Backrest:** self-supporting backrest construction with horizontally stitched padding. Cover in fabric or leather.

**Seat:** polyurethane foam padding. Cover in fabric or leather.

**Armrests:** without armrests or with polished die-cast aluminium ring armrests, optional leather pads (pads are matched to the leather upholstery; for chairs with fabric covers, the leather armrest pads are in the colour nero).

**Base:** five-star base in polished die-cast aluminium or plastic (basic dark) on double castors (Ø 60 mm). Swivel mount, height adjustable.

## AC 5 Studio

	Article no.	without VAT in SEK*	with VAT in SEK*
<b>five-star base</b>	<b>421 020 00</b>		
Fabric F30		7.832,00	<b>9.790,00</b>
Fabric F60		8.384,00	<b>10.480,00</b>
Leather L20		14.992,00	<b>18.740,00</b>
<b>Surcharges armrests</b>			
without armrests	11	0,00	<b>0,00</b>
aluminium ring armrests	14	2.224,00	<b>2.780,00</b>
leather-covered aluminium ring armrest	15	3.000,00	<b>3.750,00</b>
<b>Surcharges base</b>			
plastic basic dark	0	0,00	<b>0,00</b>
polished aluminium	1	1.592,00	<b>1.990,00</b>

Fabric F30	Fabric F60	Leather L20	Castors
. Plano	. Hopsak . Twill	. Leather	02 castors hard, braked for carpet 03 castors soft, braked for hard floor

# Aluminium Chairs EA 101/103/104

Charles & Ray Eames, 1958

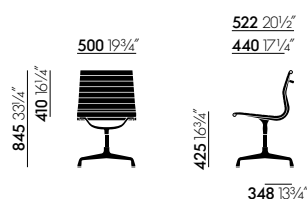

EA 101

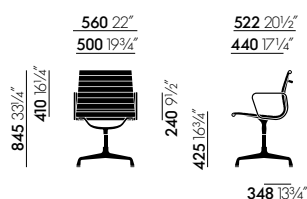

EA 103

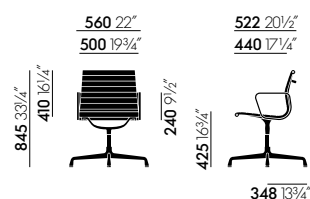

EA 104

All measurements are pursuant to EN 1335-1:2000

More detailed information is found in the chapter 'Explanation of measurements'.

**Backrest and seat:** chair with medium-height backrest; for table seating. Seat in mesh fabric or upholstered with high-frequency welded horizontal ribbing in fabric or leather. Side profiles and spreaders in die-cast aluminium, with a polished or chrome-plated finish or powder-coated in deep black.

**Armrests:** die-cast aluminium, with a polished or chrome-plated finish or powder-coated in deep black.

**Base:** four-star base in die-cast aluminium, with a polished or chrome-plated finish or powder-coated in deep black.

# Aluminium Chairs EA 101/103/104

## Charles & Ray Eames, 1958

**vitra.**

EA 101	Article no.	without VAT in SEK*	with VAT in SEK*
<b>non-swivel</b>	<b>412 321 00</b>		
without armrests			
Netweave		16.400,00	<b>20.500,00</b>
Fabric F60		16.400,00	<b>20.500,00</b>
Leather L20		22.080,00	<b>27.600,00</b>
Leather L50		26.560,00	<b>33.200,00</b>
<b>Surcharges base</b>			
polished	1	0,00	<b>0,00</b>
powder-coated in deep black	4	0,00	<b>0,00</b>
chromed	0	1.520,00	<b>1.900,00</b>

EA 103	Article no.	without VAT in SEK*	with VAT in SEK*
<b>non-swivel</b>	<b>412 323 00</b>		
with armrests			
Netweave		18.480,00	<b>23.100,00</b>
Fabric F60		18.480,00	<b>23.100,00</b>
Leather L20		24.160,00	<b>30.200,00</b>
Leather L50		28.640,00	<b>35.800,00</b>
<b>Surcharges base</b>			
polished	1	0,00	<b>0,00</b>
powder-coated in deep black	4	0,00	<b>0,00</b>
chromed	0	1.680,00	<b>2.100,00</b>

EA 104	Article no.	without VAT in SEK*	with VAT in SEK*
<b>swivel</b>	<b>412 324 00</b>		
with armrests			
Netweave		18.480,00	<b>23.100,00</b>
Fabric F60		18.480,00	<b>23.100,00</b>
Leather L20		24.160,00	<b>30.200,00</b>
Leather L50		28.640,00	<b>35.800,00</b>
<b>Surcharges base</b>			
polished	1	0,00	<b>0,00</b>
powder-coated in deep black	4	0,00	<b>0,00</b>
chromed	0	1.680,00	<b>2.100,00</b>

Fabric F60	Leather L20	Leather L50	Glides
. Hopsak	. Leather/back panel Plano	. Leather Premium F/back panel Plano	04 glides for carpet 05 felt glides for hard floor



# Aluminium Chairs EA 105/107/108

Charles & Ray Eames, 1958

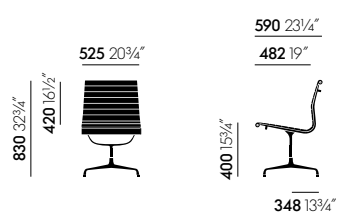

EA 105

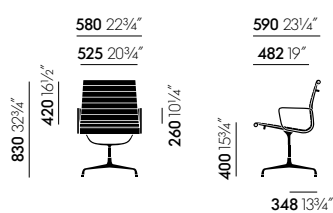

EA 107

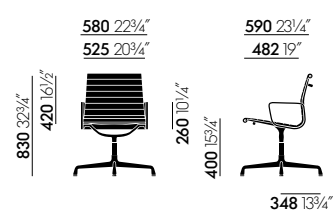

EA 108

All measurements are pursuant to EN 1335-1:2000

More detailed information is found in the chapter 'Explanation of measurements'.

**Backrest and seat:** chair with medium-high backrest. Seat in mesh fabric or upholstered with high-frequency welded horizontal ribbing in fabric or leather. Side profiles and spreaders in die-cast aluminium, with a polished or chrome-plated finish or powder-coated in deep black.

**Armrests:** die-cast aluminium, with a polished or chrome-plated finish or powder-coated in deep black.

**Base:** four-star base in die-cast aluminium, with a polished or chrome-plated finish or powder-coated in deep black.

# Aluminium Chairs EA 105/107/108

## Charles & Ray Eames, 1958

**vitra.**

EA 105	Article no.	without VAT in SEK*	with VAT in SEK*
<b>non-swivel</b>			
	<b>412 358 00</b>		
without armrests			
Netweave		19.040,00	<b>23.800,00</b>
Fabric F60		19.040,00	<b>23.800,00</b>
Leather L20		25.440,00	<b>31.800,00</b>
Leather L50		30.560,00	<b>38.200,00</b>
<b>Surcharges base</b>			
polished	1	0,00	<b>0,00</b>
powder-coated in deep black	4	0,00	<b>0,00</b>
chromed	0	1.872,00	<b>2.340,00</b>

EA 107	Article no.	without VAT in SEK*	with VAT in SEK*
<b>non-swivel</b>			
	<b>412 360 00</b>		
with armrests			
Netweave		21.120,00	<b>26.400,00</b>
Fabric F60		21.120,00	<b>26.400,00</b>
Leather L20		27.520,00	<b>34.400,00</b>
Leather L50		32.640,00	<b>40.800,00</b>
<b>Surcharges base</b>			
polished	1	0,00	<b>0,00</b>
powder-coated in deep black	4	0,00	<b>0,00</b>
chromed	0	2.032,00	<b>2.540,00</b>

EA 108	Article no.	without VAT in SEK*	with VAT in SEK*
<b>swivel</b>			
	<b>412 361 00</b>		
with armrests			
Netweave		21.120,00	<b>26.400,00</b>
Fabric F60		21.120,00	<b>26.400,00</b>
Leather L20		27.520,00	<b>34.400,00</b>
Leather L50		32.640,00	<b>40.800,00</b>
<b>Surcharges base</b>			
polished	1	0,00	<b>0,00</b>
powder-coated in deep black	4	0,00	<b>0,00</b>
chromed	0	2.032,00	<b>2.540,00</b>

Fabric F60	Leather L20	Leather L50	Glides
. Hopsak	. Leather/back panel Plano	. Leather Premium F/back panel Plano	04 glides for carpet 05 felt glides for hard floor

# Soft Pad Chairs EA 205/207/208

## Charles & Ray Eames, 1969

vitra.

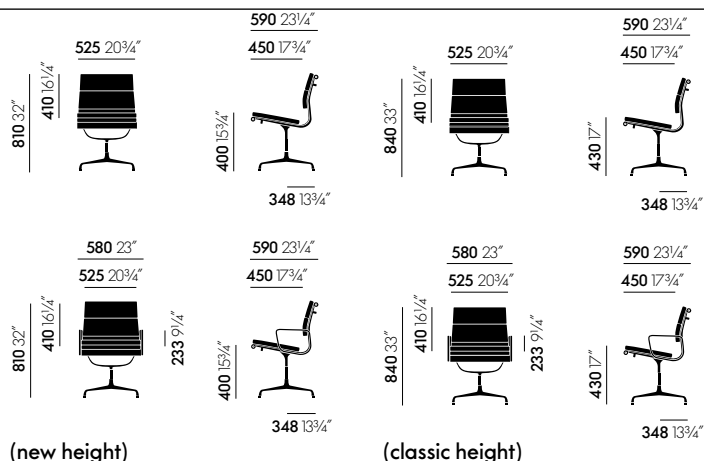

EA 208

All measurements are pursuant to EN 1335-1:2000  
More detailed information is found in the chapter 'Explanation of measurements'.

**Backrest and seat:** chair with medium-high backrest. Three sewn-on cushions with polyurethane foam upholstery in leather. Side profiles and spreaders in die-cast aluminium, with a polished or chrome-plated finish or powder-coated in deep black.

**Armrests:** die-cast aluminium, with a polished or chrome-plated finish or powder-coated in deep black.

**Base:** four-star base in die-cast aluminium, with a polished or chrome-plated finish or powder-coated in deep black. Available in two different heights.

### EA 205 (new height)

	Article no.	without VAT in SEK*	with VAT in SEK*
<b>non-swivel</b>	<b>412 325 00</b>		
without armrests			
Leather L20		27.760,00	<b>34.700,00</b>
Leather L50		33.360,00	<b>41.700,00</b>
<b>Surcharges base</b>			
polished	1	0,00	<b>0,00</b>
powder-coated in deep black	4	0,00	<b>0,00</b>
chromed	0	1.872,00	<b>2.340,00</b>

### EA 207 (new height)

	Article no.	without VAT in SEK*	with VAT in SEK*
<b>non-swivel</b>	<b>412 327 00</b>		
with armrests			
Leather L20		29.840,00	<b>37.300,00</b>
Leather L50		35.440,00	<b>44.300,00</b>
<b>Surcharges base</b>			
polished	1	0,00	<b>0,00</b>
powder-coated in deep black	4	0,00	<b>0,00</b>
chromed	0	2.032,00	<b>2.540,00</b>

### EA 208 (new height)

	Article no.	without VAT in SEK*	with VAT in SEK*
<b>swivel</b>	<b>412 328 00</b>		
with armrests			
Leather L20		29.840,00	<b>37.300,00</b>
Leather L50		35.440,00	<b>44.300,00</b>
<b>Surcharges base</b>			
polished	1	0,00	<b>0,00</b>
powder-coated in deep black	4	0,00	<b>0,00</b>
chromed	0	2.032,00	<b>2.540,00</b>

# Soft Pad Chairs EA 205/207/208

## Charles & Ray Eames, 1969

**vitra.**

EA 205 (classic height)	Article no.	without VAT in SEK*	with VAT in SEK*
<b>non-swivel</b>			
	<b>412 375 00</b>		
without armrests			
Leather L20		27.760,00	<b>34.700,00</b>
Leather L50		33.360,00	<b>41.700,00</b>
<b>Surcharges base</b>			
polished	1	0,00	<b>0,00</b>
powder-coated in deep black	4	0,00	<b>0,00</b>
chromed	0	1.872,00	<b>2.340,00</b>

EA 207 (classic height)	Article no.	without VAT in SEK*	with VAT in SEK*
<b>non-swivel</b>			
	<b>412 377 00</b>		
with armrests			
Leather L20		29.840,00	<b>37.300,00</b>
Leather L50		35.440,00	<b>44.300,00</b>
<b>Surcharges base</b>			
polished	1	0,00	<b>0,00</b>
powder-coated in deep black	4	0,00	<b>0,00</b>
chromed	0	2.032,00	<b>2.540,00</b>

EA 208 (classic height)	Article no.	without VAT in SEK*	with VAT in SEK*
<b>swivel</b>			
	<b>412 378 00</b>		
with armrests			
Leather L20		29.840,00	<b>37.300,00</b>
Leather L50		35.440,00	<b>44.300,00</b>
<b>Surcharges base</b>			
polished	1	0,00	<b>0,00</b>
powder-coated in deep black	4	0,00	<b>0,00</b>
chromed	0	2.032,00	<b>2.540,00</b>

#### Leather L20

Leather/back panel Plano

#### Leather L50

Leather Premium F (contrast seam)/back panel Plano

#### Glides

04 glides for carpet  
05 felt glides for hard floor

# Aluminium Chairs EA 117/118/119

## Charles & Ray Eames, 1958



EA 117



EA 118



EA 119

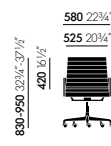

EA 117

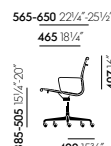

EA 118

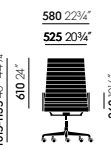

EA 119

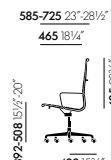

All measurements are pursuant to EN 1335-1:2000  
More detailed information is found in the chapter 'Explanation of measurements'.

**Backrest and seat:** EA 117 with medium-height backrest; EA 118 with medium-height backrest and table-oriented sitting position; EA 119 with high backrest. High-frequency welded horizontal ribbing in fabric or leather. Side profiles and spreaders in die-cast aluminium, with a polished or chrome-plated finish or powder-coated in deep black.

**Seat mechanism:** adjustable backward tilt, lockable in the forward position. Continuous seat height adjustment with gas spring.

**Armrests:** die-cast aluminium, with a polished or chrome-plated finish or powder-coated in deep black.

**Base:** five-star base in die-cast aluminium, with a polished or chrome-plated finish or powder-coated in deep black. Equipped with hard castors for carpet or soft castors for hard floors. Castor covers in black for polished and black base, with chrome-plated finish for chrome base.

# Aluminium Chairs EA 117/118/119

## Charles & Ray Eames, 1958

**vitra.**

EA 117	Article no.	without VAT in SEK*	with VAT in SEK*
<b>medium-high backrest, swivel</b>	<b>412 364 00</b>		
with armrests			
Fabric F60		26.080,00	<b>32.600,00</b>
Leather L20		32.400,00	<b>40.500,00</b>
Leather L50		37.200,00	<b>46.500,00</b>
<b>Surcharges base</b>			
polished	1	0,00	<b>0,00</b>
powder-coated in deep black	4	0,00	<b>0,00</b>
chromed	0	2.032,00	<b>2.540,00</b>

EA 118	Article no.	without VAT in SEK*	with VAT in SEK*
<b>medium-high backrest, swivel</b>	<b>412 329 00</b>		
with armrests			
Fabric F60		23.680,00	<b>29.600,00</b>
Leather L20		29.360,00	<b>36.700,00</b>
Leather L50		34.000,00	<b>42.500,00</b>
<b>Surcharges base</b>			
polished	1	0,00	<b>0,00</b>
powder-coated in deep black	4	0,00	<b>0,00</b>
chromed	0	2.032,00	<b>2.540,00</b>

EA 119	Article no.	without VAT in SEK*	with VAT in SEK*
<b>high backrest, swivel</b>	<b>412 365 00</b>		
with armrests			
Fabric F60		31.840,00	<b>39.800,00</b>
Leather L20		38.960,00	<b>48.700,00</b>
Leather L50		44.320,00	<b>55.400,00</b>
<b>Surcharges base</b>			
polished	1	0,00	<b>0,00</b>
powder-coated in deep black	4	0,00	<b>0,00</b>
chromed	0	2.920,00	<b>3.650,00</b>

Fabric F60	Leather L20	Leather L50	Castors
. Hopsak	. Leather/back panel Plano	. Leather Premium F/back panel Plano	02 castors hard, braked for carpet 03 castors soft, braked for hard floor

# Soft Pad Chairs EA 217/219

## Charles & Ray Eames, 1969

vitra.



EA 217



EA 219

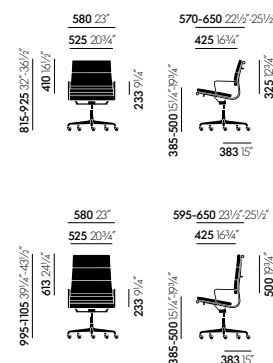

All measurements are pursuant to EN 1335-1:2000  
More detailed information is found in the chapter 'Explanation of measurements'.

**Backrest and seat:** EA 217 with medium-high backrest, EA 219 with high backrest. Sewn-on cushions with polyurethane foam upholstery in leather. Side profiles and spreaders in die-cast aluminium, with a polished or chrome-plated finish or powder-coated in deep black.

**Seat mechanism:** adjustable backward tilt, lockable in the forward position. Continuous seat height adjustment with gas spring.

**Armrests:** die-cast aluminium, with a polished or chrome-plated finish or powder-coated in deep black.

**Base:** five-star base in die-cast aluminium, with a polished or chrome-plated finish or powder-coated in deep black. Equipped with hard castors for carpet or soft castors for hard floors. Castor covers in black for polished and black powder-coated base, with chrome-plated finish for chrome base.

EA 217	Article no.	without VAT in SEK*	with VAT in SEK*
<b>medium-high backrest, swivel</b>	<b>412 381 00</b>		
with armrests			
Leather L20		34.400,00	<b>43.000,00</b>
Leather L50		40.240,00	<b>50.300,00</b>
<b>Surcharges base</b>			
polished	1	0,00	<b>0,00</b>
powder-coated in deep black	4	0,00	<b>0,00</b>
chromed	0	2.032,00	<b>2.540,00</b>

EA 219	Article no.	without VAT in SEK*	with VAT in SEK*
<b>high backrest, swivel</b>	<b>412 382 00</b>		
with armrests			
Leather L20		42.080,00	<b>52.600,00</b>
Leather L50		49.600,00	<b>62.000,00</b>
<b>Surcharges base</b>			
polished	1	0,00	<b>0,00</b>
powder-coated in deep black	4	0,00	<b>0,00</b>
chromed	0	2.920,00	<b>3.650,00</b>

### Leather L20

### Leather L50

### Castors

Leather/back panel Plano    Leather Premium F (contrast seam)/back panel Plano    02 castors hard, braked for carpet  
03 castors soft, braked for hard floor

# Aluminium Chair EA 124/125

## Charles & Ray Eames, 1958

vitra.



EA 124



EA 125

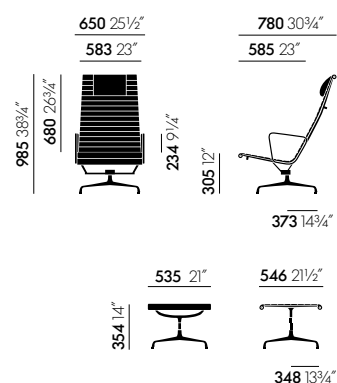

All measurements are pursuant to EN 1335-1:2000  
More detailed information is found in the chapter 'Explanation of measurements'.

### EA 124

**Backrest and seat:** chair with high backrest. High-frequency welded upholstery with horizontal ribbing; cover in fabric or leather. Side profiles and spreaders in die-cast aluminium, with a polished or chrome-plated finish or powder-coated in deep black.

**Seat mechanism:** adjustable backward tilt.

**Armrests:** die-cast aluminium, with a polished or chrome-plated finish or powder-coated in deep black.

**Base:** four-star base in die-cast aluminium, with a polished or chrome-plated finish or powder-coated in deep black.

### EA 125

**Seat:** non-swivel. Upholstered with high-frequency welded ribbing in fabric or leather. Side profiles and spreaders in die-cast aluminium, with a polished or chrome-plated finish or powder-coated in deep black.

**Base:** four-star base in die-cast aluminium, with a polished or chrome-plated finish or powder-coated in deep black.

### EA 124

	Article no.	without VAT in SEK*	with VAT in SEK*
<b>swivel</b>		<b>412 366 00</b>	
with armrests			
Fabric F60		32.800,00	<b>41.000,00</b>
Leather L20		40.240,00	<b>50.300,00</b>
Leather L50		46.400,00	<b>58.000,00</b>
<b>Surcharges base</b>			
polished	1	0,00	<b>0,00</b>
powder-coated in deep black	4	0,00	<b>0,00</b>
chromed	0	2.920,00	<b>3.650,00</b>

### EA 125

	Article no.	without VAT in SEK*	with VAT in SEK*
<b>stool</b>		<b>412 367 00</b>	
non-swivel			
Fabric F60		13.520,00	<b>16.900,00</b>
Leather L20		16.400,00	<b>20.500,00</b>
Leather L50		18.080,00	<b>22.600,00</b>
<b>Surcharges base</b>			
polished	1	0,00	<b>0,00</b>
powder-coated in deep black	4	0,00	<b>0,00</b>
chromed	0	864,00	<b>1.080,00</b>

#### Fabric F60

. Hopsak

#### Leather L20

. Leather/back panel Plano

#### Leather L50

. Leather Premium F/back panel Plano

#### Glides

04 glides for carpet  
05 felt glides for hard floor



# Soft Pad Chair EA 222/223

## Charles & Ray Eames, 1969



EA 222



EA 223

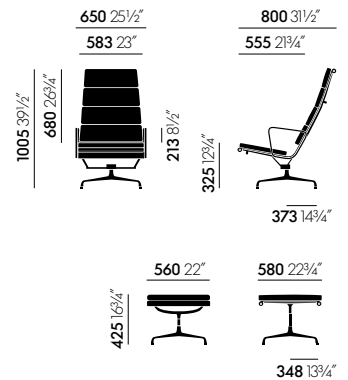

All measurements are pursuant to EN 1335-1:2000  
More detailed information is found in the chapter 'Explanation of measurements'.

### EA 222

**Backrest and seat:** chair with high backrest. Five sewn-on cushions with polyurethane foam upholstery in leather. Side profiles and spreaders in die-cast aluminium, with a polished or chrome-plated finish or powder-coated in deep black.

**Seat mechanism:** adjustable backward tilt.

**Armrests:** die-cast aluminium, with a polished or chrome-plated finish or powder-coated in deep black.

**Base:** four-star base in die-cast aluminium, with a polished or chrome-plated finish or powder-coated in deep black.

### EA 223

**Seat:** non-swivel. Sewn-on cushion with polyurethane foam upholstery in leather. Side profiles and spreaders in die-cast aluminium, with a polished or chrome-plated finish or powder-coated in deep black.

**Base:** four-star base in die-cast aluminium, with a polished or chrome-plated finish or powder-coated in deep black.

### EA 222

	Article no.	without VAT in SEK*	with VAT in SEK*
<b>swivel</b>		<b>412 383 00</b>	
with armrests			
Leather L20		42.960,00	<b>53.700,00</b>
Leather L50		49.280,00	<b>61.600,00</b>
<b>Surcharges base</b>			
polished	1	0,00	<b>0,00</b>
powder-coated in deep black	4	0,00	<b>0,00</b>
chromed	0	2.920,00	<b>3.650,00</b>

### EA 223

	Article no.	without VAT in SEK*	with VAT in SEK*
<b>Stool</b>		<b>412 384 00</b>	
non-swivel			
Leather L20		17.600,00	<b>22.000,00</b>
Leather L50		20.320,00	<b>25.400,00</b>
<b>Surcharges base</b>			
polished	1	0,00	<b>0,00</b>
powder-coated in deep black	4	0,00	<b>0,00</b>
chromed	0	864,00	<b>1.080,00</b>

#### Leather L20

#### Leather L50

#### Glides

Leather/back panel Plano    Leather Premium F (contrast seam)/back panel Plano    04 glides for carpet  
05 felt glides for hard floor

# APC

Jasper Morrison, 2016

vitra.

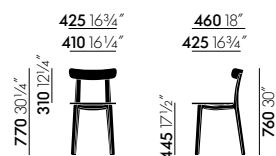

All measurements are pursuant to EN 1335-1:2000  
More detailed information is found in the chapter 'Explanation of measurements'.

**Backrest, seat and base:** dyed-through polypropylene.

**Glides:** fitted with carpet glides or felt glides for hard floors.

**Applications:** suitable for outdoor use.

## APC

Polypropylene, suitable for outdoor use

Article no.	without VAT in SEK*	with VAT in SEK*
440 388 00	3.032,00	3.790,00

### Polypropylene

- 01 white - two-tone
- 02 ice grey - two-tone
- 03 graphite grey - two-tone
- 04 ivy two-tone
- 05 brick - two-tone
- 07 buttercup - two-tone

### Glides

- 04 glides for carpet
- 05 felt glides for hard floor

# Belleville Chair

Ronan & Erwan Bouroullec, 2015

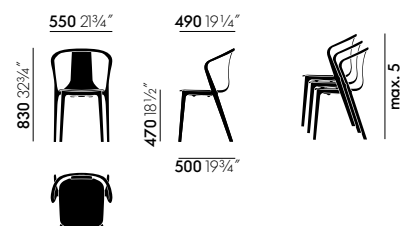

Belleville Armchair

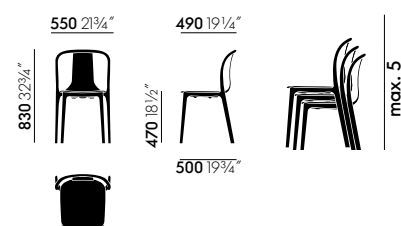

Belleville Chair

All measurements are pursuant to EN 1335-1:2000  
More detailed information is found in the chapter 'Explanation of measurements'.

## Belleville Chair

**Seat shell, base and frame:** injection-moulded polyamide. Stackable up to 5 high.

## Belleville Chair Wood

**Seat shell:** moulded plywood, protective natural lacquer finish.

**Base and frame:** injection-moulded polyamide. Stackable up to 5 high.

# Belleville Chair

Ronan & Erwan Bouroullec, 2015

**vitra.**

<b>Belleville Chair Plastic</b>	Article no.	without VAT in SEK*	with VAT in SEK*
<b>polyamide seat shell, stacking, suitable for outdoor use</b>	<b>440 298 00</b>		
Base deep black	12	3.352,00	<b>4.190,00</b>

<b>Belleville Chair Wood</b>	Article no.	without VAT in SEK*	with VAT in SEK*
<b>wooden seat shell, stacking</b>	<b>440 292 00</b>		
Base deep black	12	4.760,00	<b>5.950,00</b>

<b>Belleville Armchair Plastic</b>	Article no.	without VAT in SEK*	with VAT in SEK*
<b>polyamide seat shell, stacking, suitable for outdoor use</b>	<b>440 299 00</b>		
Base deep black	12	3.880,00	<b>4.850,00</b>

<b>Belleville Armchair Wood</b>	Article no.	without VAT in SEK*	with VAT in SEK*
<b>wooden seat shell, stacking</b>	<b>440 293 00</b>		
Base deep black	12	5.192,00	<b>6.490,00</b>

#### Seat shell Plastic

12 deep black  
30 cream  
35 basalt  
83 sea blue  
94 moss grey

#### Seat shell Wood

04 dark oak, with protective varnish  
10 natural oak, with protective varnish  
68 black ash

#### Glides

04 glides for carpet  
05 felt glides for hard floor

# Chaise Tout Bois

Jean Prouvé, 1941

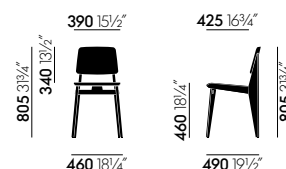

All measurements are pursuant to EN 1335-1:2000  
More detailed information is found in the chapter 'Explanation of measurements'.

**Seat and backrest:** moulded plywood veneer in natural or dark-stained oak, protective natural lacquer finish.

**Base:** non-stackable solid wood base; same type of wood as backrest and seat in natural or dark-stained oak, protective natural lacquer finish.

**Origin of wood:** solid oak (*Quercus robur*) from Croatia, veneer wood from the USA.

## Chaise Tout Bois

	Article no.	without VAT in SEK*	with VAT in SEK*
	<b>210 645 00</b>		
Oak, with protective varnish		7.920,00	<b>9.900,00</b>

### Back and seat, veneer (Chaise Tout Bois)

04 dark oak, with protective varnish  
10 natural oak, with protective varnish

### Wooden base, solid wood (Chaise Tout Bois)

04 dark stained solid oak, with protective varnish  
10 natural oak, with protective varnish

### Glides

04 glides for carpet  
05 felt glides for hard floor

# Eames Fiberglass Chairs

Charles & Ray Eames, 1950

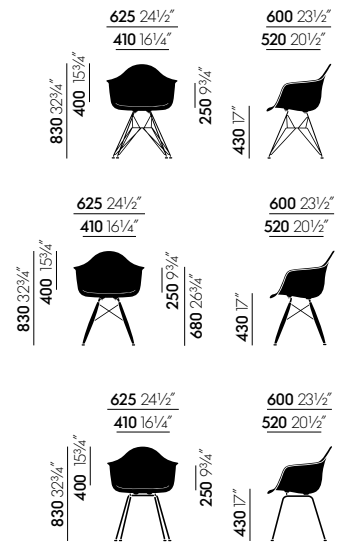

All measurements are pursuant to EN 1335-1:2000  
 More detailed information is found in the chapter 'Explanation of measurements'.

**Seat shell:** dyed-through, glass-fibre reinforced polyester (fibreglass). Just like the earliest models, today's fibreglass shells are also slightly transparent in some colours. Optionally available with a moulded foam seat cushion (screwed to the seat shell); cushion can be replaced by the Vitra service team.

## DAR

	Article no.	without VAT in SEK*	with VAT in SEK*
<b>wire base with cross struts</b>	<b>440 440 00</b>		
without upholstery			
		7.616,00	<b>9.520,00</b>
<b>wire base with cross struts</b>	<b>440 441 00</b>		
with seat upholstery			
Fabric F60		8.568,00	<b>10.710,00</b>
Fabric F200		9.816,00	<b>12.270,00</b>

# Eames Fiberglass Chairs

## Charles & Ray Eames, 1950



DAW	Article no.	without VAT in SEK*	with VAT in SEK*
<b>wood base with cross struts</b>		<b>440 445 00</b>	
without upholstery			
maple	04	9.088,00	<b>11.360,00</b>
ash	05	9.424,00	<b>11.780,00</b>
<b>wood and wire base with cross struts</b>		<b>440 446 00</b>	
with seat upholstery			
maple, fabric F60	04	10.040,00	<b>12.550,00</b>
ash, fabric F60	05	10.376,00	<b>12.970,00</b>
maple, fabric F200	04	11.288,00	<b>14.110,00</b>
ash, fabric F200	05	11.624,00	<b>14.530,00</b>

DAX	Article no.	without VAT in SEK*	with VAT in SEK*
<b>four-legged tubular steel base</b>		<b>440 450 00</b>	
without upholstery			
		7.264,00	<b>9.080,00</b>
<b>four-legged tubular steel base</b>		<b>440 451 00</b>	
with seat upholstery			
Fabric F60		8.216,00	<b>10.270,00</b>
Fabric F200		9.464,00	<b>11.830,00</b>

Fabric F60	Fabric F200	Seat shell (Eames Fiberglass Armchair)
02 Hopsak	01 Checker	01 Eames Parchment
		04 Eames Elephant Hide Grey
		05 Eames Sea Foam Green
		06 Eames Raw Umber

Base DAW	Base DAR	Base DAX	Glides
02 golden maple	01 chrome	01 chrome	04 basic dark for carpet
30 black maple	04 white powder-coated (smooth)	04 white powder-coated (smooth)	05 felt basic dark for hard floor
65 honey-toned ash	30 basic dark powder-coated (smooth)	30 basic dark powder-coated (smooth)	14 white for carpet
95 dark maple			15 felt white for hard floor

# Eames Fiberglass Chairs

## Charles & Ray Eames, 1950

**vitra.**

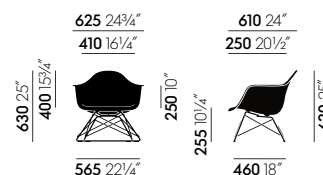

All measurements are pursuant to EN 1335-1:2000  
More detailed information is found in the chapter 'Explanation of measurements'.

**Seat shell:** dyed-through, glass-fibre reinforced polyester (fibreglass). Just like the earliest models, today's fibreglass shells are also slightly transparent in some colours. Optionally available with a moulded foam seat cushion (screwed to the seat shell); cushion can be replaced by the Vitra service team.

LAR	Article no.	without VAT in SEK*	with VAT in SEK*
<b>wire base with cross struts</b>	<b>440 460 00</b>		
without upholstery		8.592,00	<b>10.740,00</b>
<b>wire base with cross struts</b>	<b>440 461 00</b>		
with seat upholstery			
Fabric F60		9.544,00	<b>11.930,00</b>
Fabric F200		10.792,00	<b>13.490,00</b>

Fabric F60	Fabric F200	Seat shell (Eames Fiberglass Armchair)	Base LAR	Glides
. Hopsak	. Checker	01 Eames Parchment 04 Eames Elephant Hide Grey 05 Eames Sea Foam Green 06 Eames Raw Umber	01 chrome 04 white powder-coated (smooth) 30 basic dark powder-coated (smooth)	04 basic dark for carpet 05 felt basic dark for hard floor



# Eames Fiberglass Chairs

## Charles & Ray Eames, 1950

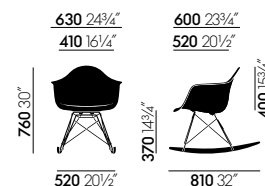

All measurements are pursuant to EN 1335-1:2000  
More detailed information is found in the chapter 'Explanation of measurements'.

**Seat shell:** dyed-through, glass-fibre reinforced polyester (fibreglass). Just like the earliest models, today's fibreglass shells are also slightly transparent in some colours. Optionally available with a moulded foam seat cushion (screwed to the seat shell); cushion can be replaced by the Vitra service team.

RAR	Article no.	without VAT in SEK*	with VAT in SEK*
<b>rocking chair</b>		<b>440 455 00</b>	
without upholstery			9.480,00
			<b>11.850,00</b>
<b>rocking chair</b>		<b>440 456 00</b>	
with seat upholstery			
Fabric F60		10.432,00	<b>13.040,00</b>
Fabric F200		11.680,00	<b>14.600,00</b>

Fabric F60	Fabric F200	Seat shell (Eames Fiberglass Armchair)	Base RAR	Rocking skids RAR
Hopsak	Checker	01 Eames Parchment 04 Eames Elephant Hide Grey 05 Eames Sea Foam Green 06 Eames Raw Umber	01 chrome 04 white powder-coated (smooth) 30 basic dark powder-coated (smooth)	02 golden maple 95 dark maple

# Eames Fiberglass Chairs

Charles & Ray Eames, 1950

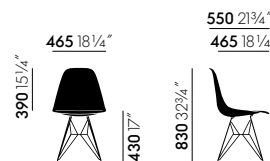

All measurements are pursuant to EN 1335-1:2000  
More detailed information is found in the chapter 'Explanation of measurements'.

**Seat shell:** dyed-through, glass-fibre reinforced polyester (fibreglass). Just like the earliest models, today's fibreglass shells are also slightly transparent in some colours. Optionally available with a moulded foam seat cushion (screwed to the seat shell); cushion can be replaced by the Vitra service team.

**Base:** non-stacking four-legged wire base with cross struts. (DSR = Dining Height Side Chair Rod Base)

DSR	Article no.	without VAT in SEK*	with VAT in SEK*
<b>wire base with cross struts, non-stacking</b>	<b>440 400 00</b>		
without upholstery		5.928,00	<b>7.410,00</b>
<b>wire base with cross struts, non-stacking</b>	<b>440 401 00</b>		
with seat upholstery			
Fabric F60		6.952,00	<b>8.690,00</b>
Fabric F200		8.136,00	<b>10.170,00</b>

Seat shell (Eames Fiberglass Side Chair)	Fabric F60	Fabric F200	Base DSR	Glides
01 Eames Parchment	Hopsak	Checker	01 chrome	04 basic dark for carpet
02 Eames Navy Blue			04 white powder-coated (smooth)	05 felt basic dark for hard floor
03 Eames Red Orange			30 basic dark powder-coated (smooth)	14 white for carpet
04 Eames Elephant Hide Grey				15 felt white for hard floor
05 Eames Sea Foam Green				
06 Eames Raw Umber				
07 Eames Ochre Light				
08 Eames Ochre Dark				
09 Eames Classic Red				

# Eames Fiberglass Chairs

Charles & Ray Eames, 1950

 Quickship

<b>Eames Fiberglass Side Chair DSR, seat shell in colour Eames Elephant Hide Grey</b>		Article no.	without VAT in SEK*	with VAT in SEK*
<b>Base powder-coated in basic dark (smooth)</b>	Felt glides for hard floors in basic dark	<b>QS4 040 0A</b>	5.928,00	<b>7.410,00</b>
<b>Base powder-coated in basic dark (smooth)</b>	Carpet glides in basic dark	<b>QS4 040 0C</b>	5.928,00	<b>7.410,00</b>

 Quickship

<b>Eames Fiberglass Side Chair DSR, shell colour Eames Sea Foam Green</b>		Article no.	without VAT in SEK*	with VAT in SEK*
<b>Base powder-coated in basic dark (smooth)</b>	Felt glides for hard floors in basic dark	<b>QS4 040 0B</b>	5.928,00	<b>7.410,00</b>
<b>Base powder-coated in basic dark (smooth)</b>	Carpet glides in basic dark	<b>QS4 040 0D</b>	5.928,00	<b>7.410,00</b>

# Eames Fiberglass Chairs

Charles & Ray Eames, 1950

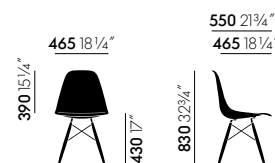

All measurements are pursuant to EN 1335-1:2000  
More detailed information is found in the chapter 'Explanation of measurements'.

**Seat shell:** dyed-through, glass-fibre reinforced polyester (fibreglass). Just like the earliest models, today's fibreglass shells are also slightly transparent in some colours. Optionally available with a moulded foam seat cushion (screwed to the seat shell); cushion can be replaced by the Vitra service team.

**Base:** non-stackable wooden base in various shades of maple or honey-toned ash, stained and lacquered finish. Steel rod cross struts in basic dark. (DSW = Dining Height Side Chair Wood Base)

**Origin of wood:** ash (*Fraxinus excelsior*) and maple (*Acer platanoides*) from Western Europe and/or Poland.

DSW	Article no.	without VAT in SEK*	with VAT in SEK*
<b>wood and wire base with cross struts, non-stacking</b>	<b>440 405 00</b>		
without upholstery			
Base maple		7.400,00	<b>9.250,00</b>
Base ash		7.736,00	<b>9.670,00</b>
<b>wood and wire base with cross struts, non-stacking</b>	<b>440 406 00</b>		
with seat upholstery			
maple, fabric F60		8.424,00	<b>10.530,00</b>
ash, fabric F60		8.760,00	<b>10.950,00</b>
maple, fabric F200		9.608,00	<b>12.010,00</b>
ash, fabric F200		9.944,00	<b>12.430,00</b>

Seat shell (Eames Fiberglass Side Chair)	Fabric F60	Fabric F200	Base DSW	Glides
01 Eames Parchment	Hopsak	Checker	02 golden maple	04 basic dark for carpet
02 Eames Navy Blue			30 black maple	05 felt basic dark for hard floor
03 Eames Red Orange			65 honey-toned ash	14 white for carpet
04 Eames Elephant Hide Grey			95 dark maple	15 felt white for hard floor
05 Eames Sea Foam Green				
06 Eames Raw Umber				
07 Eames Ochre Light				
08 Eames Ochre Dark				
09 Eames Classic Red				

# Eames Fiberglass Chairs

Charles & Ray Eames, 1950



## Eames Fiberglass Side Chair DSW, shell colour Eames Elephant Hide Grey

		Article no.	without VAT in SEK*	with VAT in SEK*
Base in black maple	Felt glides for hard floors in basic dark	<b>QS4 040 5A</b>	7.400,00	<b>9.250,00</b>
Base in black maple	Carpet glides in basic dark	<b>QS4 040 5E</b>	7.400,00	<b>9.250,00</b>
Base in dark maple	Felt glides for hard floors in basic dark	<b>QS4 040 5B</b>	7.400,00	<b>9.250,00</b>
Base in dark maple	Carpet glides in basic dark	<b>QS4 040 5F</b>	7.400,00	<b>9.250,00</b>



## Eames Fiberglass Side Chair DSW, shell colour Eames Sea Foam Green

		Article no.	without VAT in SEK*	with VAT in SEK*
Base in black maple	Felt glides for hard floors in basic dark	<b>QS4 040 5C</b>	7.400,00	<b>9.250,00</b>
Base in black maple	Carpet glides in basic dark	<b>QS4 040 5G</b>	7.400,00	<b>9.250,00</b>
Base in dark maple	Felt glides for hard floors in basic dark	<b>QS4 040 5D</b>	7.400,00	<b>9.250,00</b>
Base in dark maple	Carpet glides in basic dark	<b>QS4 040 5H</b>	7.400,00	<b>9.250,00</b>

# Eames Fiberglass Chairs

## Charles & Ray Eames, 1950

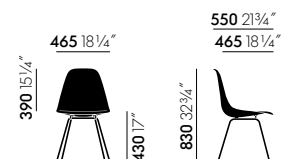

All measurements are pursuant to EN 1335-1:2000  
More detailed information is found in the chapter 'Explanation of measurements'.

**Seat shell:** dyed-through, glass-fibre reinforced polyester (fibreglass). Just like the earliest models, today's fibreglass shells are also slightly transparent in some colours. Optionally available with a moulded foam seat cushion (screwed to the seat shell); cushion can be replaced by the Vitra service team.

**Base:** non-stacking four-legged tubular steel base. (DSX = Dining Height Side Chair X-Base)

DSX	Article no.	without VAT in SEK*	with VAT in SEK*
<b>four-legged tubular steel base, non-stacking</b>	<b>440 410 00</b>		
without upholstery		5.576,00	<b>6.970,00</b>
<b>four-legged tubular steel base, non-stacking</b>	<b>440 411 00</b>		
with seat upholstery			
Fabric F60		6.600,00	<b>8.250,00</b>
Fabric F200		7.784,00	<b>9.730,00</b>

Seat shell (Eames Fiberglass Side Chair)	Fabric F60	Fabric F200	Base DSX	Glides
01 Eames Parchment	Hopsak	Checker	01 chrome	04 basic dark for carpet
02 Eames Navy Blue			04 white powder-coated (smooth)	05 felt basic dark for hard floor
03 Eames Red Orange			30 basic dark powder-coated (smooth)	14 white for carpet
04 Eames Elephant Hide Grey				15 felt white for hard floor
05 Eames Sea Foam Green				
06 Eames Raw Umber				
07 Eames Ochre Light				
08 Eames Ochre Dark				
09 Eames Classic Red				

# Eames Fiberglass Chairs

Charles & Ray Eames, 1950

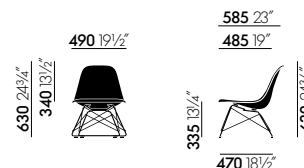

All measurements are pursuant to EN 1335-1:2000  
More detailed information is found in the chapter 'Explanation of measurements'.

**Seat shell:** dyed-through, glass-fibre reinforced polyester (fibreglass). Just like the earliest models, today's fibreglass shells are also slightly transparent in some colours. Optionally available with a moulded foam seat cushion (screwed to the seat shell); cushion can be replaced by the Vitra service team.

**Base:** wire base with cross struts, chrome-plated or powder-coated finish. Seat height 260 mm. (LSR = Lounge Height Side Chair, Rod Base)

LSR	Article no.	without VAT in SEK*	with VAT in SEK*
<b>wire base with cross struts, non-stacking</b>	<b>440 495 00</b>		
without upholstery		6.904,00	<b>8.630,00</b>
<b>wire base with cross struts, non-stacking</b>	<b>440 496 00</b>		
with seat upholstery			
Fabric F60		7.928,00	<b>9.910,00</b>
Fabric F200		9.112,00	<b>11.390,00</b>

Seat shell (Eames Fiberglass Side Chair)	Fabric F60	Fabric F200	Base LSR	Glides
01 Eames Parchment	Hopsak	Checker	01 chrome	04 basic dark for carpet
02 Eames Navy Blue			04 white powder-coated (smooth)	05 felt basic dark for hard floor
03 Eames Red Orange			30 basic dark powder-coated (smooth)	
04 Eames Elephant Hide Grey				
05 Eames Sea Foam Green				
06 Eames Raw Umber				
07 Eames Ochre Light				
08 Eames Ochre Dark				
09 Eames Classic Red				

# Eames Plastic Chairs

## Charles & Ray Eames, 1950

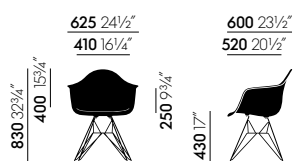

DAR, new height

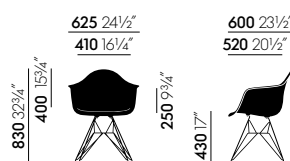

DAR, new height

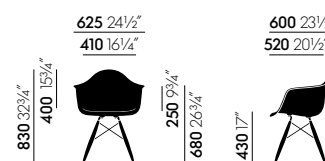

DAW, new height

All measurements are pursuant to EN 1335-1:2000  
More detailed information is found in the chapter 'Explanation of measurements'.

**Seat shell:** dyed-through polypropylene. All models are available with a seat cushion (screwed to the seat shell) or full upholstery. The fully upholstered version has moulded polyurethane foam padding covered in fabric, attached to the shell with a welted edge. Different shell and upholstery colours and various bases provide a multitude of possible combinations.

**Options:** the Eames Plastic Chair is available as a visitor chair, dining chair, rocking chair, swivel chair or in stacking versions and with ganging brackets for row seating. Beam-mounted shells are suited for use in waiting areas.

### Eames Plastic Armchair DAR

**Base:** wire base with cross struts, chrome-plated or powder-coated finish. The powder-coated version is suitable for outdoor use. (DAR = Dining Height Armchair Rod Base)

**Note:** special additives retard the fading of colours due to UV radiation. However, if the chair is exposed to sunlight for prolonged periods, the colour may change over time. We recommend limited exposure to sunlight.

### Eames Plastic Armchair DAW

**Base:** wooden base in various shades of maple or honey-toned ash, stained and lacquered finish. Steel rod cross struts in basic dark. (DAW = Dining Height Armchair Wood Base)

**Origin of wood:** ash (*Fraxinus excelsior*) and maple (*Acer platanoides*) from Western Europe and/or Poland.



# Eames Plastic Chairs

## Charles & Ray Eames, 1950

vitra.

DAR (new height)	Article no.	without VAT in SEK*	with VAT in SEK*
<b>wire base with cross struts</b>	<b>440 320 00</b>		
without upholstery		4.088,00	<b>5.110,00</b>
<b>wire base with cross struts</b>	<b>440 321 00</b>		
with seat upholstery			
Fabric F60		5.040,00	<b>6.300,00</b>
Fabric F200		6.288,00	<b>7.860,00</b>
<b>wire base with cross struts</b>	<b>440 322 00</b>		
with full upholstery			
Fabric F60		6.904,00	<b>8.630,00</b>
<b>DAW (new height)</b>	<b>Article no.</b>	<b>without VAT in SEK*</b>	<b>with VAT in SEK*</b>
<b>wood and wire base with cross struts</b>	<b>440 325 00</b>		
without upholstery			
maple		5.560,00	<b>6.950,00</b>
ash		5.896,00	<b>7.370,00</b>
<b>wood and wire base with cross struts</b>	<b>440 326 00</b>		
with seat upholstery			
Maple, fabric F60		6.512,00	<b>8.140,00</b>
Ash, fabric F60		6.848,00	<b>8.560,00</b>
Maple, fabric F200		7.760,00	<b>9.700,00</b>
Ash, fabric F200		8.096,00	<b>10.120,00</b>
<b>wood and wire base with cross struts</b>	<b>440 327 00</b>		
with full upholstery			
Maple, fabric F60		8.376,00	<b>10.470,00</b>
Ash, fabric F60		8.712,00	<b>10.890,00</b>

Fabric F60	Fabric F200	Seat shell	Base DAW	Base DAR	Edge	Glides
Hopsak	Checker	03 poppy red 04 white 11 pebble 12 deep black 23 ice grey 24 light grey 26 sunlight	34 mustard 41 pale rose 42 green 43 rusty orange 48 forest 56 granite grey 83 sea blue	02 golden maple 30 black maple 65 honey-toned ash 95 dark maple	01 chrome 04 white powder-coated (smooth) 30 basic dark powder-coated (smooth)	01 basic dark 04 white 05 felt basic dark for hard floor 14 white for carpet 15 felt white for hard floor

# Eames Plastic Chairs

## Charles & Ray Eames, 1950

**vitra.**

 Quickship

<b>Eames Plastic Armchair DAR, shell colour white</b>		Article no.	without VAT in SEK*	with VAT in SEK*
chrome-plated base	Felt glides for hard floors in basic dark	<b>QS4 032 0A</b>	4.088,00	<b>5.110,00</b>
Chrome-plated base	Carpet glides in basic dark	<b>QS4 032 0C</b>	4.088,00	<b>5.110,00</b>

 Quickship

<b>Eames Plastic Armchair DAR, shell colour deep black</b>		Article no.	without VAT in SEK*	with VAT in SEK*
chrome-plated base	Felt glides for hard floors in basic dark	<b>QS4 032 0B</b>	4.088,00	<b>5.110,00</b>
chrome-plated base	Carpet glides in basic dark	<b>QS4 032 0D</b>	4.088,00	<b>5.110,00</b>

 Quickship

<b>Eames Plastic Armchair DAW, shell colour white</b>		Article no.	without VAT in SEK*	with VAT in SEK*
Base in honey-toned ash	Felt glides for hard floors in basic dark	<b>QS4 032 5A</b>	5.896,00	<b>7.370,00</b>
Base in honey-toned ash	Carpet glides in basic dark	<b>QS4 032 5F</b>	5.896,00	<b>7.370,00</b>
Base in golden maple	Felt glides for hard floors in basic dark	<b>QS4 032 5B</b>	5.560,00	<b>6.950,00</b>
Base in golden maple	Carpet glides in basic dark	<b>QS4 032 5E</b>	5.560,00	<b>6.950,00</b>

 Quickship

<b>Eames Plastic Armchair DAW, shell colour deep black</b>		Article no.	without VAT in SEK*	with VAT in SEK*
Base in honey-toned ash	Felt glides for hard floors in basic dark	<b>QS4 032 5C</b>	5.896,00	<b>7.370,00</b>
Base in honey-toned ash	Carpet glides in basic dark	<b>QS4 032 5H</b>	5.896,00	<b>7.370,00</b>
Base in golden maple	Felt glides for hard floors in basic dark	<b>QS4 032 5D</b>	5.560,00	<b>6.950,00</b>
Base in golden maple	Carpet glides in basic dark	<b>QS4 032 5G</b>	5.560,00	<b>6.950,00</b>

Fabric F60	Fabric F200	Seat shell		Base DAW		Base DAR		Edge	Glides
Hopsak	Checker	03 poppy red	34 mustard	02 golden maple	01 chrome	01 basic dark	04 basic dark for carpet	04 white	05 felt basic dark for hard floor
		04 white	41 pale rose	30 black maple	04 white powder-coated (smooth)		14 white for carpet		15 felt white for hard floor
		11 pebble	42 green	65 honey-toned ash	30 basic dark powder-coated (smooth)				
		12 deep black	43 rusty orange	95 dark maple					
		23 ice grey	48 forest						
		24 light grey	56 granite grey						
		26 sunlight	83 sea blue						

# Eames Plastic Chairs

## Charles & Ray Eames, 1950

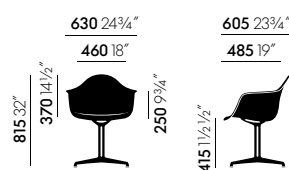

DAL

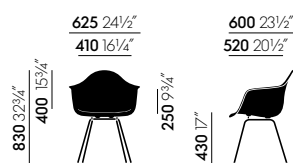

DAX, new height

All measurements are pursuant to EN 1335-1:2000  
More detailed information is found in the chapter 'Explanation of measurements'.

**Seat shell:** dyed-through polypropylene. All models are available with a seat cushion (screwed to the seat shell) or full upholstery. The fully upholstered version has moulded polyurethane foam padding covered in fabric, attached to the shell with a welted edge. Different shell and upholstery colours and various bases provide a multitude of possible combinations.

**Options:** the Eames Plastic Chair is available as a visitor chair, dining chair, rocking chair, swivel chair or in stacking versions and with ganging brackets for row seating. Beam-mounted shells are suited for use in waiting areas.

### Eames Plastic Armchair DAL

**Base:** La Fonda base in polished die-cast aluminium. (DAL = Dining Height Armchair La Fonda Base)

### Eames Plastic Armchair DAX

**Base:** four-legged tubular steel base, chrome-plated or powder-coated. The powder-coated version is suitable for outdoor use. (DAX = Dining Height Armchair X-Base)

**Note:** special additives retard the fading of colours due to UV radiation. However, if the chair is exposed to sunlight for prolonged periods, the colour may change over time. We recommend limited exposure to sunlight.

# Eames Plastic Chairs

## Charles & Ray Eames, 1950

**vitra.**

DAL	Article no.	without VAT in SEK*	with VAT in SEK*
<b>polished die-cast aluminium base</b>	<b>440 360 00</b>		
without upholstery		7.256,00	<b>9.070,00</b>
<b>polished die-cast aluminium base</b>	<b>440 361 00</b>		
with seat upholstery			
Fabric F60		8.208,00	<b>10.260,00</b>
Fabric F200		9.456,00	<b>11.820,00</b>
<b>polished die-cast aluminium base</b>	<b>440 362 00</b>		
with full upholstery			
Fabric F60		10.072,00	<b>12.590,00</b>
<b>DAX (new height)</b>	Article no.	without VAT in SEK*	with VAT in SEK*
<b>four-legged tubular steel base</b>	<b>440 330 00</b>		
without upholstery		3.736,00	<b>4.670,00</b>
<b>four-legged tubular steel base</b>	<b>440 331 00</b>		
with seat upholstery			
Fabric F60		4.688,00	<b>5.860,00</b>
Fabric F200		5.936,00	<b>7.420,00</b>
<b>four-legged tubular steel base</b>	<b>440 332 00</b>		
with full upholstery			
Fabric F60		6.552,00	<b>8.190,00</b>

Fabric F60	Fabric F200	Seat shell	Base DAL	Base DAX	Edge	Glides
Hopsak	Checker	03 poppy red 04 white 11 pebble 12 deep black 23 ice grey 24 light grey 26 sunlight	34 mustard 41 pale rose 42 green 43 rusty orange 48 forest 56 granite grey 83 sea blue	03 polished aluminium 01 chrome 04 white powder-coated (smooth) 30 basic dark powder-coated (smooth)	01 basic dark 04 white	04 basic dark for carpet 05 felt basic dark for hard floor 14 white for carpet 15 felt white for hard floor

# Eames Plastic Chairs

## Charles & Ray Eames, 1950

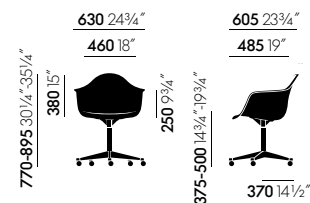

All measurements are pursuant to EN 1335-1:2000  
More detailed information is found in the chapter 'Explanation of measurements'.

**Seat shell:** dyed-through polypropylene. All models are available with a seat cushion (screwed to the seat shell) or full upholstery. The fully upholstered version has moulded polyurethane foam padding covered in fabric, attached to the shell with a welted edge. Different shell and upholstery colours and various bases provide a multitude of possible combinations.

**Options:** the Eames Plastic Chair is available as a visitor chair, dining chair, rocking chair, swivel chair or in stacking versions and with ganging brackets for row seating. Beam-mounted shells are suited for use in waiting areas.

### Eames Plastic Armchair PACC

**Base:** five-star base in polished die-cast aluminium with double castors in basic dark. (PACC = Pivot Armchair Cast Base on Castors)

PACC	Article no.	without VAT in SEK*	with VAT in SEK*
<b>castor-based swivel chair, height-adjustable</b>	<b>440 355 00</b>		
without upholstery		6.984,00	<b>8.730,00</b>
<b>castor-based swivel chair, height-adjustable</b>	<b>440 356 00</b>		
with seat upholstery			
Fabric F60		7.936,00	<b>9.920,00</b>
Fabric F200		9.184,00	<b>11.480,00</b>
<b>castor-based swivel chair, height-adjustable</b>	<b>440 357 00</b>		
with full upholstery			
Fabric F60		9.800,00	<b>12.250,00</b>

Fabric F60	Fabric F200	Seat shell	Edge	Castors
Hopsak	Checker	03 poppy red 04 white 11 pebble 12 deep black 23 ice grey 24 light grey 26 sunlight	34 mustard 41 pale rose 42 green 43 rusty orange 48 forest 56 granite grey 83 sea blue	01 basic dark 04 white 02 castors hard, braked for carpet 03 castors soft, braked for hard floor

# Eames Plastic Chairs

## Charles & Ray Eames, 1950

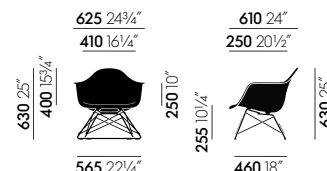

All measurements are pursuant to EN 1335-1:2000  
More detailed information is found in the chapter 'Explanation of measurements'.

**Seat shell:** dyed-through polypropylene. All models are available with a seat cushion (screwed to the seat shell) or full upholstery. The fully upholstered version has moulded polyurethane foam padding covered in fabric, attached to the shell with a welted edge. Different shell and upholstery colours and various bases provide a multitude of possible combinations.

**Options:** the Eames Plastic Chair is available as a visitor chair, dining chair, rocking chair, swivel chair or in stacking versions and with ganging brackets for row seating. Beam-mounted shells are suited for use in waiting areas.

**LAR base:** wire base with cross struts, chrome-plated or powder-coated finish. Seat height 256 mm. (LAR = Lounge Height Armchair, Rod Base)

LAR	Article no.	without VAT in SEK*	with VAT in SEK*
<b>wire base with cross struts</b>	<b>440 475 00</b>		
without upholstery		5.064,00	<b>6.330,00</b>
<b>wire base with cross struts</b>	<b>440 476 00</b>		
with seat upholstery			
Fabric F60		6.016,00	<b>7.520,00</b>
Fabric F200		7.264,00	<b>9.080,00</b>
<b>wire base with cross struts</b>	<b>440 477 00</b>		
with full upholstery			
Fabric F60		7.880,00	<b>9.850,00</b>

Fabric F60	Fabric F200	Seat shell	Base LAR	Edge	Glides
Hopsak	Checker	03 poppy red 04 white 11 pebble 12 deep black 23 ice grey 24 light grey 26 sunlight	34 mustard 41 pale rose 42 green 43 rusty orange 48 forest 56 granite grey 83 sea blue	01 chrome 04 white powder-coated (smooth) 30 basic dark powder-coated (smooth)	01 basic dark 04 white 04 basic dark for carpet 05 felt basic dark for hard floor

# Eames Plastic Armchair RAR

Charles & Ray Eames, 1950

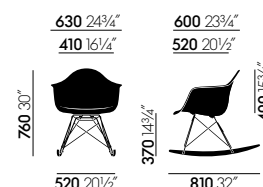

All measurements are pursuant to EN 1335-1:2000  
More detailed information is found in the chapter 'Explanation of measurements'.

**Seat shell:** dyed-through polypropylene. All models are available with a seat cushion (screwed to the seat shell) or full upholstery. The fully upholstered version has moulded polyurethane foam padding covered in fabric, attached to the shell with a welted edge. Different shell and upholstery colours and various bases provide a multitude of possible combinations.

**Options:** the Eames Plastic Chair is available as a visitor chair, dining chair, rocking chair, swivel chair or in stacking versions and with ganging brackets for row seating. Beam-mounted shells are suited for use in waiting areas.

## Eames Plastic Armchair RAR

**RAR base:** wire base with cross struts, chrome-plated or powder-coated, solid maple runners. (RAR = Rocking Armchair Rod Base)

**Origin of wood:** maple (*Acer platanoides*) from Western Europe and/or Poland.

RAR	Article no.	without VAT in SEK*	with VAT in SEK*
<b>rocking chair</b>	<b>440 365 00</b>		
without seat upholstery		5.952,00	<b>7.440,00</b>
<b>rocking chair</b>	<b>440 366 00</b>		
with seat upholstery			
Fabric F60		6.904,00	<b>8.630,00</b>
Fabric F200		8.152,00	<b>10.190,00</b>
<b>rocking chair</b>	<b>440 367 00</b>		
with full upholstery			
Fabric F60		8.768,00	<b>10.960,00</b>

Fabric F60	Fabric F200	Seat shell	Base RAR	Edge	Rocking skids RAR
Hopsak	Checker	03 poppy red 04 white 11 pebble 12 deep black 23 ice grey 24 light grey 26 sunlight	34 mustard 41 pale rose 42 green 43 rusty orange 48 forest 56 granite grey 83 sea blue	01 chrome 04 white powder-coated (smooth) 30 basic dark powder-coated (smooth)	01 basic dark 04 white 02 golden maple 95 dark maple

# Eames Plastic Chairs

## Charles & Ray Eames, 1950

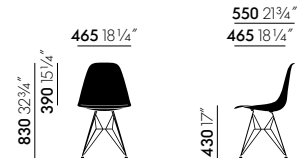

### DSR, new height

All measurements are pursuant to EN 1335-1:2000  
More detailed information is found in the chapter 'Explanation of measurements'.

**Seat shell:** dyed-through polypropylene. All models are available with a seat cushion (screwed to the seat shell) or full upholstery. The fully upholstered version has moulded polyurethane foam padding covered in fabric, attached to the shell with a welted edge. Different shell and upholstery colours and various bases provide a multitude of possible combinations.

**Options:** the Eames Plastic Chair is available as a visitor chair, dining chair, rocking chair, swivel chair or in stacking versions and with ganging brackets for row seating. Beam-mounted shells are suited for use in waiting areas.

**Base:** non-stacking four-legged wire base with cross struts. The powder-coated version is suitable for outdoor use. (DSR = Dining Height Side Chair Rod Base)

**Note:** special additives retard the fading of colours due to UV radiation. However, if the chair is exposed to sunlight for prolonged periods, the colour may change over time. We recommend limited exposure to sunlight.

### DSR (new height)

	Article no.	without VAT in SEK*	with VAT in SEK*
<b>wire base with cross struts, non-stacking</b>	<b>440 300 00</b>		
without upholstery		2.952,00	<b>3.690,00</b>
<b>wire base with cross struts, non-stacking</b>	<b>440 301 00</b>		
with seat upholstery			
Fabric F60		3.976,00	<b>4.970,00</b>
Fabric F200		5.160,00	<b>6.450,00</b>
<b>wire base with cross struts, non-stacking</b>	<b>440 302 00</b>		
with full upholstery			
Fabric F60		4.984,00	<b>6.230,00</b>
Fabric F200		7.384,00	<b>9.230,00</b>

Fabric F60	Fabric F200	Seat shell	Base DSR	Edge	Glides	
Hopsak	Checker	03 poppy red 04 white 11 pebble 12 deep black 23 ice grey 24 light grey 26 sunlight	34 mustard 41 pale rose 42 green 43 rusty orange 48 forest 56 granite grey 83 sea blue	01 chrome 04 white powder-coated (smooth) 30 basic dark powder-coated (smooth)	01 basic dark 04 white	04 basic dark for carpet 05 felt basic dark for hard floor 14 white for carpet 15 felt white for hard floor



# Eames Plastic Chairs

Charles & Ray Eames, 1950



## DSR Colours

	Article no.	without VAT in SEK*	with VAT in SEK*
Wire base with cross struts, powder-coated, non-stacking, glides in black			
without upholstery			
Shell in pebble 11, base in Eames Sea Foam Green 31	440 300 01	2.952,00	3.690,00
Shell in mustard 34, base in citron 92	440 300 02	2.952,00	3.690,00
Shell in sea blue 83, base in sky blue 93	440 300 03	2.952,00	3.690,00
Shell in forest 48, base in dark green 24	440 300 04	2.952,00	3.690,00

## Quickship

### Eames Plastic Side Chair DSR, shell colour white

		Article no.	without VAT in SEK*	with VAT in SEK*
Chrome-plated base	Felt glides for hard floors in basic dark	QS4 030 0A	2.952,00	3.690,00
Chrome-plated base	Carpet glides in basic dark	QS4 030 0C	2.952,00	3.690,00

## Quickship

### Eames Plastic Side Chair DSR, shell colour deep black

		Article no.	without VAT in SEK*	with VAT in SEK*
Chrome-plated base	Felt glides for hard floors in basic dark	QS4 030 0B	2.952,00	3.690,00
Chrome-plated base	Carpet glides in basic dark	QS4 030 0D	2.952,00	3.690,00

# Eames Plastic Chairs

## Charles & Ray Eames, 1950

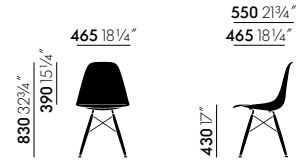

### DSW, new height

All measurements are pursuant to EN 1335-1:2000  
More detailed information is found in the chapter 'Explanation of measurements'.

**Seat shell:** dyed-through polypropylene. All models are available with a seat cushion (screwed to the seat shell) or full upholstery. The fully upholstered version has moulded polyurethane foam padding covered in fabric, attached to the shell with a welted edge. Different shell and upholstery colours and various bases provide a multitude of possible combinations.

**Options:** the Eames Plastic Chair is available as a visitor chair, dining chair, rocking chair, swivel chair or in stacking versions and with ganging brackets for row seating. Beam-mounted shells are suited for use in waiting areas.

**Base:** non-stackable wooden base in various shades of maple or honey-toned ash, stained and lacquered finish. Steel rod cross struts in basic dark. (DSW = Dining Height Side Chair Wood Base)

**Origin of wood:** ash (*Fraxinus excelsior*) and maple (*Acer platanoides*) from Western Europe and/or Poland.

### DSW (new height)

	Article no.	without VAT in SEK*	with VAT in SEK*
<b>wood and wire base with cross struts, non-stacking</b>	<b>440 305 00</b>		
without upholstery			
maple		4.424,00	<b>5.530,00</b>
ash		4.760,00	<b>5.950,00</b>
<b>wood and wire base with cross struts, non-stacking</b>	<b>440 306 00</b>		
with seat upholstery			
Maple, Fabric F60		5.448,00	<b>6.810,00</b>
Ash, fabric F60		5.784,00	<b>7.230,00</b>
Maple, fabric F200		6.632,00	<b>8.290,00</b>
Ash, fabric F200		6.968,00	<b>8.710,00</b>
<b>wood and wire base with cross struts, non-stacking</b>	<b>440 307 00</b>		
with full upholstery			
Maple, Fabric F60		6.456,00	<b>8.070,00</b>
Ash, fabric F60		6.792,00	<b>8.490,00</b>
Maple, fabric F200		8.856,00	<b>11.070,00</b>
Ash, fabric F200		9.192,00	<b>11.490,00</b>

Fabric F60	Fabric F200	Seat shell	Base DSW	Edge	Glides
Hopsak	Checker	03 poppy red	34 mustard	02 golden maple	04 basic dark for carpet
		04 white	41 pale rose	30 black maple	05 felt basic dark for hard floor
		11 pebble	42 green	65 honey-toned ash	14 white for carpet
		12 deep black	43 rusty orange	95 dark maple	15 felt white for hard floor
		23 ice grey	48 forest		
		24 light grey	56 granite grey		
		26 sunlight	83 sea blue		

# Eames Plastic Chairs

Charles & Ray Eames, 1950



## Eames Plastic Side Chair DSW, shell colour white

		Article no.	without VAT in SEK*	with VAT in SEK*
Base in honey-toned ash	Felt glides for hard floors in basic dark	<b>QS4 030 5B</b>	4.760,00	<b>5.950,00</b>
Base in honey-toned ash	Carpet glides in basic dark	<b>QS4 030 5F</b>	4.760,00	<b>5.950,00</b>
Base in golden maple	Felt glides for hard floors in basic dark	<b>QS4 030 5A</b>	4.424,00	<b>5.530,00</b>
Base in golden maple	Carpet glides in basic dark	<b>QS4 030 5E</b>	4.424,00	<b>5.530,00</b>



## Eames Plastic Side Chair DSW, shell colour deep black

		Article no.	without VAT in SEK*	with VAT in SEK*
Base in honey-toned ash	Felt glides for hard floors in basic dark	<b>QS4 030 5D</b>	4.760,00	<b>5.950,00</b>
Base in honey-toned ash	Carpet glides in basic dark	<b>QS4 030 5H</b>	4.760,00	<b>5.950,00</b>
Base in golden maple	Felt glides for hard floors in basic dark	<b>QS4 030 5C</b>	4.424,00	<b>5.530,00</b>
Base in golden maple	Carpet glides in basic dark	<b>QS4 030 5G</b>	4.424,00	<b>5.530,00</b>

# Eames Plastic Chairs

## Charles & Ray Eames, 1950

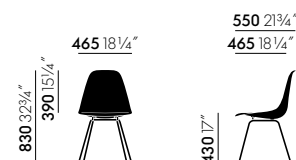

### DSX, new height

All measurements are pursuant to EN 1335-1:2000  
More detailed information is found in the chapter 'Explanation of measurements'.

**Seat shell:** dyed-through polypropylene. All models are available with a seat cushion (screwed to the seat shell) or full upholstery. The fully upholstered version has moulded polyurethane foam padding covered in fabric, attached to the shell with a welted edge. Different shell and upholstery colours and various bases provide a multitude of possible combinations.

**Options:** the Eames Plastic Chair is available as a visitor chair, dining chair, rocking chair, swivel chair or in stacking versions and with ganging brackets for row seating. Beam-mounted shells are suited for use in waiting areas.

**Base:** non-stacking four-legged tubular steel base. The powder-coated version is suitable for outdoor use. (DSX = Dining Height Side Chair X-Base)

**Note:** special additives retard the fading of colours due to UV radiation. However, if the chair is exposed to sunlight for prolonged periods, the colour may change over time. We recommend limited exposure to sunlight.

DSX (new height)	Article no.	without VAT in SEK*	with VAT in SEK*
<b>four-legged tubular steel base, non-stacking</b>	<b>440 310 00</b>		
without upholstery		2.600,00	<b>3.250,00</b>
<b>four-legged tubular steel base, non-stacking</b>	<b>440 311 00</b>		
with seat upholstery			
Fabric F60		3.624,00	<b>4.530,00</b>
Fabric F200		4.808,00	<b>6.010,00</b>
<b>four-legged tubular steel base, non-stacking</b>	<b>440 312 00</b>		
with full upholstery			
Fabric F60		4.632,00	<b>5.790,00</b>
Fabric F200		7.032,00	<b>8.790,00</b>

Fabric F60	Fabric F200	Seat shell	Base DSX	Edge	Glides
Hopsak	Checker	03 poppy red 04 white 11 pebble 12 deep black 23 ice grey 24 light grey 26 sunlight	34 mustard 41 pale rose 42 green 43 rusty orange 48 forest 56 granite grey 83 sea blue	01 chrome 04 white powder-coated (smooth) 30 basic dark powder-coated (smooth)	01 basic dark 04 white 04 basic dark for carpet 05 felt basic dark for hard floor 14 white for carpet 15 felt white for hard floor

# Eames Plastic Chairs

## Charles & Ray Eames, 1950

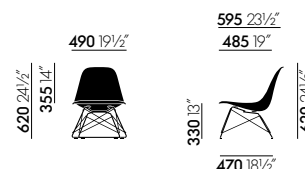

### LSR

All measurements are pursuant to EN 1335-1:2000  
More detailed information is found in the chapter 'Explanation of measurements'.

**Seat shell:** dyed-through polypropylene. All models are available with a seat cushion (screwed to the seat shell) or full upholstery. The fully upholstered version has moulded polyurethane foam padding covered in fabric, attached to the shell with a welted edge. Different shell and upholstery colours and various bases provide a multitude of possible combinations.

**Options:** the Eames Plastic Chair is available as a visitor chair, dining chair, rocking chair, swivel chair or in stacking versions and with ganging brackets for row seating. Beam-mounted shells are suited for use in waiting areas.

**Base:** wire base with cross struts, chrome-plated or powder-coated finish. The powder-coated version is suitable for outdoor use. Seat height 260 mm. (LSR = Lounge Height Side Chair, Rod Base)

**Note:** special additives retard the fading of colours due to UV radiation. However, if the chair is exposed to sunlight for prolonged periods, the colour may change over time. We recommend limited exposure to sunlight.

LSR	Article no.	without VAT in SEK*	with VAT in SEK*
<b>wire base with cross struts, non-stacking</b>	<b>440 490 00</b>		
without upholstery		3.928,00	<b>4.910,00</b>
<b>wire base with cross struts, non-stacking</b>	<b>440 491 00</b>		
with seat upholstery			
Fabric F60		4.952,00	<b>6.190,00</b>
Fabric F200		6.136,00	<b>7.670,00</b>
<b>wire base with cross struts, non-stacking</b>	<b>440 492 00</b>		
with full upholstery			
Fabric F60		5.960,00	<b>7.450,00</b>
Fabric F200		8.360,00	<b>10.450,00</b>

Fabric F60	Fabric F200	Seat shell	Base LSR	Glides
Hopsak	Checker	03 poppy red 04 white 11 pebble 12 deep black 23 ice grey 24 light grey 26 sunlight	34 mustard 41 pale rose 42 green 43 rusty orange 48 forest 56 granite grey 83 sea blue	01 chrome 04 white powder-coated (smooth) 30 basic dark powder-coated (smooth) 04 basic dark for carpet 05 felt basic dark for hard floor

# Eames Plastic Chairs

## Charles & Ray Eames, 1950



DSS

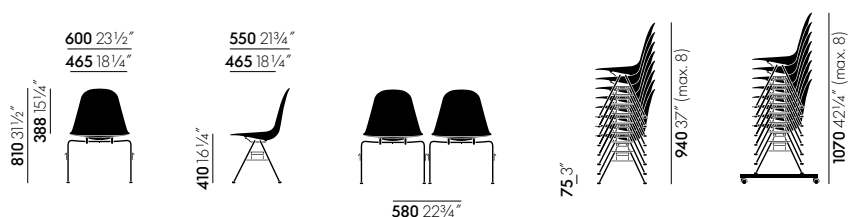

All measurements are pursuant to EN 1335-1:2000  
 More detailed information is found in the chapter 'Explanation of measurements'.

**Seat shell:** dyed-through polypropylene. All models are available with a seat cushion (screwed to the seat shell) or full upholstery. The fully upholstered version has moulded polyurethane foam padding covered in fabric, attached to the shell with a welted edge. Different shell and upholstery colours and various bases provide a multitude of possible combinations.

**Options:** the Eames Plastic Chair is available as a visitor chair, dining chair, rocking chair, swivel chair or in stacking versions and with ganging brackets for row seating. Beam-mounted shells are suited for use in waiting areas.

**Base:** chrome-plated tubular steel base, DSS with ganging bracket. (DSS = Dining Height Side Chair Stacking Base)

**Stacking:** Version without upholstery can be stacked up to 8 chairs on the floor or on a stacking trolley. Version with seat and full upholstery: up to 5 chairs can be stacked on the floor, up to 6 chairs on a stacking trolley.

# Eames Plastic Chairs

## Charles & Ray Eames, 1950

vitra.

DSS	Article no.	without VAT in SEK*	with VAT in SEK*
<b>stacking and linking</b>	<b>440 345 00</b>		
without upholstery		2.600,00	<b>3.250,00</b>
<b>stacking and linking</b>	<b>440 346 00</b>		
with seat upholstery			
Fabric F60		3.624,00	<b>4.530,00</b>
Fabric F200		4.808,00	<b>6.010,00</b>
<b>stacking and linking</b>	<b>440 347 00</b>		
with full upholstery			
Fabric F60		4.632,00	<b>5.790,00</b>
Fabric F200		7.032,00	<b>8.790,00</b>

Stacking dolly	Article no.	without VAT in SEK*	with VAT in SEK*
<b>for up to 8 upholstered chairs</b>	<b>442 027 00</b>	6.160,00	<b>7.700,00</b>
<b>for 4 chairs with seat cushions or 6 with full upholstery</b>	<b>442 028 00</b>	6.600,00	<b>8.250,00</b>

Number clips	Article no.	without VAT in SEK*	with VAT in SEK*
<b>Set of 10 items</b>	<b>442 044 00</b>		
	01	176,00	<b>220,00</b>

Row numbering element	Article no.	without VAT in SEK*	with VAT in SEK*
<b>Plastic sign to clip to the chair at the end of a row</b>	<b>442 021 00</b>	104,00	<b>130,00</b>

Fabric F60	Fabric F200	Seat shell	Number clips	Edge	Glides
Hopsak	Checker	03 poppy red 04 white 11 pebble 12 deep black 23 ice grey 24 light grey 26 sunlight	34 mustard 41 pale rose 42 green 43 rusty orange 48 forest 56 granite grey 83 sea blue	01 numbers (1 set 1-10) 02 numbers (1 set 11-20) 03 numbers (1 set 21-30) 04 numbers (1 set 31-40) 05 numbers (1 set 41-50)	01 basic dark 04 white 04 basic dark for carpet 05 felt basic dark for hard floor 14 white for carpet 15 felt white for hard floor

# Eames Plastic Chairs

Charles & Ray Eames, 1950

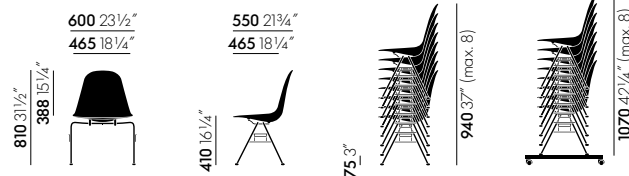

## DSS-N

All measurements are pursuant to EN 1335-1:2000  
More detailed information is found in the chapter 'Explanation of measurements'.

**Seat shell:** dyed-through polypropylene. All models are available with a seat cushion (screwed to the seat shell) or full upholstery. The fully upholstered version has moulded polyurethane foam padding covered in fabric, attached to the shell with a welted edge. Different shell and upholstery colours and various bases provide a multitude of possible combinations.

**Options:** the Eames Plastic Chair is available as a visitor chair, dining chair, rocking chair, swivel chair or in stacking versions and with ganging brackets for row seating. Beam-mounted shells are suited for use in waiting areas.

**Base:** chrome-plated tubular steel base, DSS-N without ganging brackets. (DSS-N = Dining Height Side Chair Stacking Base Non-Link)

**Stacking:** Version without upholstery can be stacked up to 8 chairs on the floor or on a stacking trolley. Version with seat and full upholstery: up to 5 chairs can be stacked on the floor, up to 6 chairs on a stacking trolley.

DSS-N	Article no.	without VAT in SEK*	with VAT in SEK*
<b>stacking</b>	<b>440 340 00</b>		
without upholstery		2.600,00	<b>3.250,00</b>
<b>stacking</b>	<b>440 341 00</b>		
with seat upholstery			
Fabric F60		3.624,00	<b>4.530,00</b>
Fabric F200		4.808,00	<b>6.010,00</b>
<b>stacking</b>	<b>440 342 00</b>		
with full upholstery			
Fabric F60		4.632,00	<b>5.790,00</b>
Fabric F200		7.032,00	<b>8.790,00</b>
<b>Stacking dolly</b>	Article no.	without VAT in SEK*	with VAT in SEK*
<b>for up to 8 unupholstered chairs</b>	<b>442 027 00</b>	6.160,00	<b>7.700,00</b>
<b>for 4 chairs with seat cushions or 6 with full upholstery</b>	<b>442 028 00</b>	6.600,00	<b>8.250,00</b>

Fabric F60	Fabric F200	Seat shell	Number clips	Edge	Glides
Hopsak	Checker	03 poppy red	34 mustard	01 basic dark	04 basic dark for carpet
		04 white	41 pale rose	04 white	05 felt basic dark for hard floor
		11 pebble	42 green		14 white for carpet
		12 deep black	43 rusty orange		15 felt white for hard floor
		23 ice grey	48 forest		
		24 light grey	56 granite grey		
		26 sunlight	83 sea blue		



# Eames Plastic Chairs

## Charles & Ray Eames, 1950

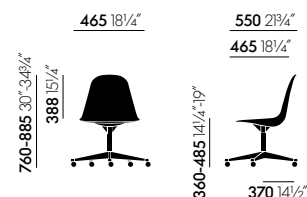

### PSCC

All measurements are pursuant to EN 1335-1:2000  
More detailed information is found in the chapter 'Explanation of measurements'.

**Seat shell:** dyed-through polypropylene. All models are available with a seat cushion (screwed to the seat shell) or full upholstery. The fully upholstered version has moulded polyurethane foam padding covered in fabric, attached to the shell with a welted edge. Different shell and upholstery colours and various bases provide a multitude of possible combinations.

**Options:** the Eames Plastic Chair is available as a visitor chair, dining chair, rocking chair, swivel chair or in stacking versions and with ganging brackets for row seating. Beam-mounted shells are suited for use in waiting areas.

**Base:** five-star base in polished die-cast aluminium with double castors in basic dark. (PSCC = Pivot Side Chair Cast Base on Castors)

### PSCC

	Article no.	without VAT in SEK*	with VAT in SEK*
<b>castor-based swivel chair, height-adjustable</b>	<b>440 335 00</b>		
without upholstery			
		5.848,00	<b>7.310,00</b>
<b>castor-based swivel chair, height-adjustable</b>	<b>440 336 00</b>		
with seat upholstery			
Fabric F60		6.872,00	<b>8.590,00</b>
Fabric F200		8.056,00	<b>10.070,00</b>
<b>castor-based swivel chair, height-adjustable</b>	<b>440 337 00</b>		
with full upholstery			
Fabric F60		7.880,00	<b>9.850,00</b>
Fabric F200		10.280,00	<b>12.850,00</b>

Fabric F60	Fabric F200	Seat shell	Edge	Castors
Hopsak	Checker	03 poppy red 04 white 11 pebble 12 deep black 23 ice grey 24 light grey 26 sunlight	34 mustard 41 pale rose 42 green 43 rusty orange 48 forest 56 granite grey 83 sea blue	01 basic dark 04 white 02 castors hard, braked for carpet 03 castors soft, braked for hard floor

# EVO-C

Jasper Morrison, 2020

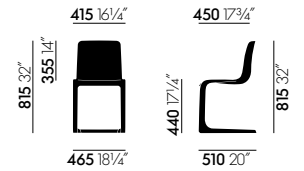

All measurements are pursuant to EN 1335-1:2000  
 More detailed information is found in the chapter 'Explanation of measurements'.

**Back, seat and base:** dyed-through polypropylene, 100% recyclable. Matt finish.

## EVO-C

### All-plastic chair

Polypropylene, recyclable

Article no.	without VAT in SEK*	with VAT in SEK*
<b>440 478 00</b>		
	3.592,00	<b>4.490,00</b>

### Plastic

- 03 poppy red
- 49 ivory
- 54 graphite grey
- 62 light mint

# Fauteuil Direction

Jean Prouvé, 1951

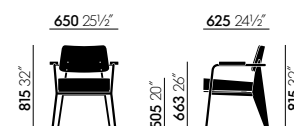

**Seat and backrest:** polyurethane filling; cover in fabric or leather.

**Seat height:** 505 mm (445 mm with applied load, measured in accordance with EN 1335-1:2000).

**Armrests:** solid wood in natural oak with oiled finish, dark stained oak with protective natural lacquer finish, or American walnut with oiled finish.

**Base:** bent sheet steel and tubular steel, powder-coated (smooth).

**Glides:** hard glides for carpet or felt glides for hard floors.

**Origin of wood:** oak (*Quercus robur*) from Western Europe and/or Poland; American walnut (*Juglans nigra*) from the USA.

**Note:** the steel frame in Métal Brut has a raw irregular surface protected by a transparent powder coating.

## Fauteuil Direction

	Article no.	without VAT in SEK*	with VAT in SEK*
	<b>210 439 00</b>		
Fabric F60		20.880,00	<b>26.100,00</b>
Fabric F80		21.360,00	<b>26.700,00</b>
Fabric F100		21.760,00	<b>27.200,00</b>
Leather L50		26.400,00	<b>33.000,00</b>
<b>Surcharges base</b>			
Colour group 1		0,00	<b>0,00</b>
Colour group 2		920,00	<b>1.150,00</b>

Fabric F60	Fabric F80	Fabric F100	Leather L50	Armrests	Glides
· Twill	· Tress	· Nubia	· Leather Premium F	04 dark stained solid oak, with protective varnish	04 glides for carpet
· Volo				70 natural solid oak, oiled	05 felt glides for hard floor
				75 solid American walnut, oiled	

### Base frame Colour group 1

06 Japanese red powder-coated (smooth)  
12 deep black powder-coated (smooth)  
88 Prouvé Blanc Colombe (Ecrú) powder-coated (smooth)

### Base frame Colour group 2

13 Prouvé Gris Vermeer powder-coated (smooth)  
14 Prouvé Bleu Dynastie powder-coated (smooth)  
18 Prouvé Blé Vert powder-coated (smooth)  
41 Prouvé Bleu Marcoule powder-coated (smooth)  
94 Prouvé Métal Brut powder-coated (transparent, smooth)

## HAL

Jasper Morrison, 2010/2014

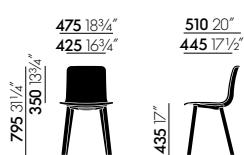

HAL RE Wood

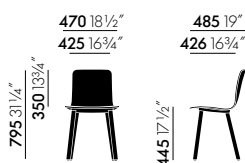

HAL Ply Wood

All measurements are pursuant to EN 1335-1:2000

More detailed information is found in the chapter 'Explanation of measurements'.

## HAL RE Wood

**Seat shell:** recycled, dyed-through polypropylene, with optional seat cushion (screwed to the seat shell).

**Base:** non-stackable wooden base in natural or dark oak. Connecting element between shell and base in die-cast aluminium, powder-coated in dim grey.

**Origin of wood:** oak (*Quercus robur*) from Western Europe and/or Poland.

## HAL Ply Wood

**Seat shell:** plywood.

**Base:** non-stackable wooden base in natural oak or dark oak. Connecting element between shell and base in die-cast aluminium, powder-coated in dim grey.

**Origin of wood:** oak (*Quercus robur*) from Western Europe and/or Poland.

**Glides:** colour matched to the small attachment parts for the seat shell, choice of white (except HAL Wood and HAL Ply Wood) or deep black. All bases fitted with glides for carpet; felt glides optionally available for hard floors.

## HAL

Jasper Morrison, 2010/2014

HAL RE Wood	Article no.	without VAT in SEK*	with VAT in SEK*
<b>wood base, non-stacking</b>	<b>440 500 00</b>		
Base natural oak, with protective varnish, without seat upholstery	10	4.376,00	<b>5.470,00</b>
Base dark oak, with protective varnish, without seat upholstery	04	4.376,00	<b>5.470,00</b>
<b>wood base, non-stacking</b>	<b>440 501 00</b>		
Base natural oak, with protective varnish, with seat upholstery F60	10	5.464,00	<b>6.830,00</b>
Base dark oak, with protective varnish, with seat upholstery F60	04	5.464,00	<b>6.830,00</b>

HAL Ply Wood	Article no.	without VAT in SEK*	with VAT in SEK*
<b>wooden base, non-stacking</b>	<b>440 222 00</b>		
Seat shell natural oak, with protective varnish	01	6.360,00	<b>7.950,00</b>
Seat shell dark oak, with protective varnish	02	6.360,00	<b>7.950,00</b>

Seat fabric F60	Seat shell HAL RE	Colours (Glides)	Glides
Hopsak	12 deep black RE 14 ivy RE 23 ice grey RE 29 brick RE 31 warm grey RE 35 basalt RE 85 cotton white RE 86 cardboard RE	04 white 12 deep black	04 glides for carpet 05 felt glides for hard floor

## HAL

Jasper Morrison, 2010/2014

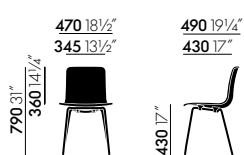

HAL RE Tube

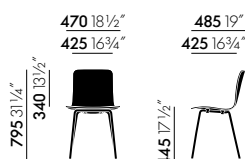

HAL Ply Tube

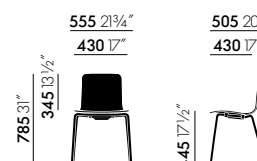

HAL Ply Tube Stackable

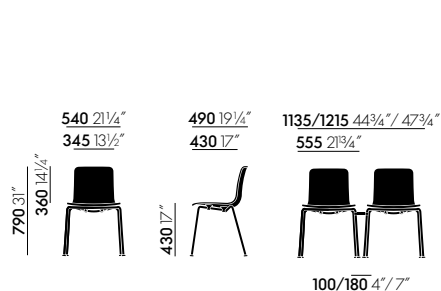

HAL RE Tube Stackable

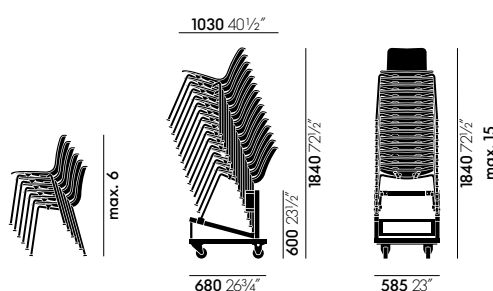

All measurements are pursuant to EN 1335-1:2000  
More detailed information is found in the chapter 'Explanation of measurements'.

## HAL RE Tube

**Seat shell:** dyed-through recycled polypropylene, with optional seat cushion (screwed to the seat shell).

**Base:** four-legged base in tubular steel, non-stackable, chrome-plated or powder-coated in ivory or basic dark. The powder-coated version is suitable for outdoor use.

## HAL Ply Tube

**Seat shell:** plywood (USA).

**Base:** four-legged base in tubular steel, non-stackable, chrome-plated or powder-coated in ivory or basic dark.

## HAL RE Tube Stackable

**Seat shell:** dyed-through, recycled polypropylene.

**Base:** stackable four-legged base made of tubular steel, chrome-plated or powder-coated in basic dark. Up to 6 chairs can be stacked on the floor, up to 15 chairs on a stacking trolley.

**Note:** as stacking can cause scratches, we recommend the chrome version for this purpose.

## HAL Ply Tube Stackable

**Seat shell:** plywood (USA).

**Base:** stackable four-legged base made of tubular steel, chrome-plated or powder-coated in basic dark. Up to 6 chairs can be stacked on the floor, up to 11 chairs on a stacking trolley.

**Note:** as stacking can cause scratches, we recommend the chrome version for this purpose.

**Glides:** colour matched to the small attachment parts for the seat shell, choice of white (except HAL Wood and HAL Ply Wood) or deep black. All bases fitted with glides for carpet; felt glides optionally available for hard floors.

HAL RE Tube	Article no.	without VAT in SEK*	with VAT in SEK*
<b>four-legged tubular steel base, non-stacking</b>	<b>440 502 00</b>		
Base chromed	01	2.520,00	<b>3.150,00</b>
Base powder-coated basic dark, suitable for outdoor use	30	2.520,00	<b>3.150,00</b>
Base powder-coated ivory, suitable for outdoor use	49	2.520,00	<b>3.150,00</b>
<b>four-legged tubular steel base, non-stacking</b>	<b>440 503 00</b>		
Base chromed, with seat upholstery F60	01	3.608,00	<b>4.510,00</b>
Base powder-coated basic dark, with seat upholstery F60	30	3.608,00	<b>4.510,00</b>
Base powder-coated ivory, with seat upholstery F60	49	3.608,00	<b>4.510,00</b>

HAL Ply Tube	Article no.	without VAT in SEK*	with VAT in SEK*
<b>four-legged tubular steel base, non-stacking</b>	<b>440 221 00</b>		
Seat shell natural oak, with protective varnish	01	4.504,00	<b>5.630,00</b>
Seat shell dark oak, with protective varnish	02	4.504,00	<b>5.630,00</b>

HAL RE Tube Stackable	Article no.	without VAT in SEK*	with VAT in SEK*
<b>four-legged tubular steel base, stackable</b>	<b>440 504 00</b>		
Base chromed, without seat upholstery	01	2.832,00	<b>3.540,00</b>
Base basic dark without seat upholstery	30	2.832,00	<b>3.540,00</b>

HAL Ply Tube Stackable	Article no.	without VAT in SEK*	with VAT in SEK*
<b>four-legged tubular steel base, stacking</b>	<b>440 215 00</b>		
Base chrome-plated, Seat shell natural oak, with protective varnish	0101	4.816,00	<b>6.020,00</b>
Base chrome-plated, Seat shell dark oak, with protective varnish	0102	4.816,00	<b>6.020,00</b>
Base powder-coated in basic dark, Seat shell natural oak, with protective varnish	3001	4.816,00	<b>6.020,00</b>
Base powder-coated in basic dark, Seat shell dark oak, with protective varnish	3002	4.816,00	<b>6.020,00</b>

Seat fabric F60	Seat shell HAL RE	Base HAL Ply Tube	Colours (Glides)	Glides
Hopsak	12 deep black RE 14 ivy RE 23 ice grey RE 29 brick RE 31 warm grey RE 35 basalt RE 85 cotton white RE 86 cardboard RE	01 chrome 30 basic dark powder-coated (smooth) 49 ivory powder-coated (textured)	04 white 12 deep black	04 glides for carpet 05 felt glides for hard floor

# HAL Soft Wood

Jasper Morrison, 2021

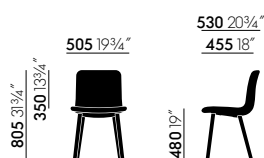

## HAL Soft Wood

All measurements are pursuant to EN 1335-1:2000  
More detailed information is found in the chapter 'Explanation of measurements'.

## HAL Soft Wood

**Seat shell:** glass-fibre reinforced polyamide. Polyurethane foam padding, replaceable fabric cover (to be carried out by Vitra Service only).

**Base:** non-stackable wooden base in natural or dark oak.

**Seat shell and base connection:** die-cast aluminium, powder-coated finish.

## HAL Soft Wood

	Article no.	without VAT in SEK*	with VAT in SEK*
<b>wood base, non-stacking</b>	<b>440 485 00</b>		
<b>Seat</b>			
Fabric F30		7.080,00	<b>8.850,00</b>
Fabric F40		7.280,00	<b>9.100,00</b>
Fabric F60		7.672,00	<b>9.590,00</b>
Fabric F80		7.992,00	<b>9.990,00</b>
Fabric F120		8.720,00	<b>10.900,00</b>

Fabric F30	Fabric F40	Fabric F60	Fabric F80	Fabric F120	Glides	Base HAL Wood, HAL Ply Wood, HAL Soft Wood
Plano	Laser RE	Volo	Dumet	Credo	04 glides for carpet 05 felt glides for hard floor	04 dark stained solid oak, with protective varnish 10 natural oak, with protective varnish



# HAL Soft Tube

Jasper Morrison, 2021

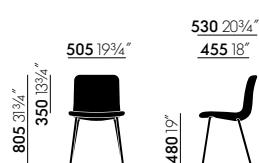

## HAL Soft Tube

All measurements are pursuant to EN 1335-1:2000  
More detailed information is found in the chapter 'Explanation of measurements'.

## HAL Soft Tube

**Seat shell:** glass-fibre reinforced polyamide. Polyurethane foam padding, replaceable fabric cover (to be carried out by Vitra Service only).

**Base:** four-legged tubular steel base, chrome-plated finish or powder-coated in basic dark.

## HAL Soft Tube

	Article no.	without VAT in SEK*	with VAT in SEK*
<b>four-legged tubular steel base, non-stacking</b>	<b>440 486 00</b>		
<b>Seat</b>			
Fabric F30		5.752,00	<b>7.190,00</b>
Fabric F40		5.960,00	<b>7.450,00</b>
Fabric F60		6.360,00	<b>7.950,00</b>
Fabric F80		6.640,00	<b>8.300,00</b>
Fabric F120		7.400,00	<b>9.250,00</b>

Fabric F30	Fabric F40	Fabric F60	Fabric F80	Fabric F120	Glides	Base
Plano	Laser RE	Volo	Dumet	Credo	04 glides for carpet 05 felt glides for hard floor	01 chrome 30 basic dark powder-coated (textured)

# HAL Soft Tube Stackable

Jasper Morrison, 2021



## HAL Soft Tube Stackable

All measurements are pursuant to EN 1335-1:2000  
More detailed information is found in the chapter 'Explanation of measurements'.

## HAL Soft Tube Stackable

**Seat shell:** glass-fibre reinforced polyamide. Polyurethane foam padding, replaceable fabric cover (to be carried out by Vitra Service only).

**Base:** stackable four-legged tubular steel base, chrome-plated finish or powder-coated in basic dark. Up to 6 chairs can be stacked on the floor.

## HAL Soft Tube Stackable

	Article no.	without VAT in SEK*	with VAT in SEK*
<b>four-legged tubular steel base, stackable</b>	<b>440 487 00</b>		
<b>Seat</b>			
Fabric F30		6.040,00	<b>7.550,00</b>
Fabric F40		6.280,00	<b>7.850,00</b>
Fabric F60		6.632,00	<b>8.290,00</b>
Fabric F80		6.952,00	<b>8.690,00</b>
Fabric F120		7.672,00	<b>9.590,00</b>

Fabric F30	Fabric F40	Fabric F60	Fabric F80	Fabric F120	Glides	Base
Plano	Laser RE	Volo	Dumet	Credo	04 glides for carpet 05 felt glides for hard floor	01 chrome 30 basic dark powder-coated (textured)

## HAL

Jasper Morrison, 2010/2014

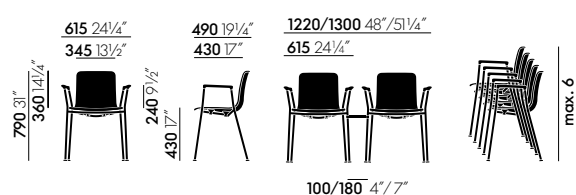

HAL RE Tube Armrest

100/180 4'7"

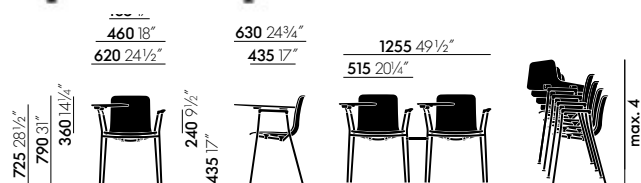

HAL RE Tube Writing Tablet

180 7"

All measurements are pursuant to EN 1335-1:2000

More detailed information is found in the chapter 'Explanation of measurements'.

#### HAL RE Tube Armrest

**Seat shell:** dyed-through, recycled polypropylene.

**Base:** four-legged tubular steel base, chrome-plated finish. Up to 6 chairs can be stacked on the floor or on a stacking trolley. Armrest colour matched to seat shell.

#### HAL RE Tube Writing Tablet

**Seat shell:** dyed-through, recycled polypropylene.

**Base:** four-legged base in tubular steel, with a foldable tablet desk in black, always mounted on the right (from a seated position). Up to 4 chairs can be stacked on the floor or on a stacking trolley.

**Glides:** colour matched to the small attachment parts for the seat shell, choice of white (except HAL Wood and HAL Ply Wood) or deep black. All bases fitted with glides for carpet; felt glides optionally available for hard floors.

HAL RE Tube Armrest	Article no.	without VAT in SEK*	with VAT in SEK*
<b>four-legged tubular steel base, stackable</b>	<b>440 505 00</b>		
Base chromed		3.616,00	<b>4.520,00</b>

HAL RE Tube Writing Tablet	Article no.	without VAT in SEK*	with VAT in SEK*
<b>tubular steel base, stacking</b>	<b>440 506 00</b>		
Base chromed		6.056,00	<b>7.570,00</b>

Seat shell HAL RE	Colours (Glides)	Glides
12 deep black RE	04 white	04 glides for carpet
14 ivy RE	12 deep black	05 felt glides for hard floor
23 ice grey RE		
29 brick RE		
31 warm grey RE		
35 basalt RE		
85 cotton white RE		
86 cardboard RE		

## HAL

Jasper Morrison, 2010/2014

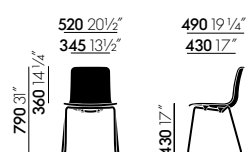

HAL RE Sledge

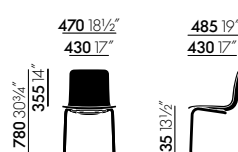

HAL RE Cantilever



All measurements are pursuant to EN 1335-1:2000

More detailed information is found in the chapter 'Explanation of measurements'.

## HAL RE Sledge

**Seat shell:** dyed-through, recycled polypropylene.

**Base:** sledge base in chrome-plated tubular steel. Up to 6 chairs can be stacked on the floor, up to 13 chairs on a stacking trolley. Also available with row connectors.

## HAL RE Cantilever

**Seat shell:** dyed-through, recycled polypropylene, with optional seat cushion (screwed to the seat shell).

**Base:** cantilever base in chrome-plated tubular steel, non-stackable.

**Glides:** colour matched to the small attachment parts for the seat shell, choice of white (except HAL Wood and HAL Ply Wood) or deep black. All bases fitted with glides for carpet; felt glides optionally available for hard floors.

<b>HAL RE Sledge</b>	Article no.	without VAT in SEK*	with VAT in SEK*
<b>sledge tubular steel base, stacking, with row connectors</b>	<b>440 507 00</b>		
Base chromed		3.312,00	<b>4.140,00</b>
<b>sledge tubular steel base, stacking, without row connectors</b>	<b>440 508 00</b>		
Base chromed		2.760,00	<b>3.450,00</b>
<b>HAL RE Cantilever</b>	Article no.	without VAT in SEK*	with VAT in SEK*
<b>cantilever tubular steel base, non-stacking</b>	<b>440 509 00</b>		
Base chromed, without seat upholstery		3.432,00	<b>4.290,00</b>
<b>cantilever tubular steel base, non-stacking</b>	<b>440 510 00</b>		
Base chromed, with seat upholstery F60		4.520,00	<b>5.650,00</b>

Seat fabric F60	Seat shell HAL RE	Colours (Glides)	Glides
Hopsak	12 deep black RE 14 ivy RE 23 ice grey RE 29 brick RE 31 warm grey RE 35 basalt RE 85 cotton white RE 86 cardboard RE	04 white 12 deep black	04 glides for carpet 05 felt glides for hard floor

## HAL

Jasper Morrison, 2010/2014

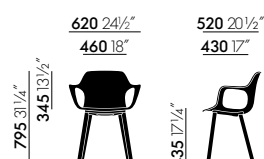

HAL RE Armchair Wood

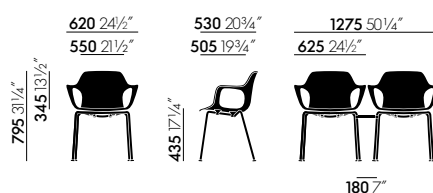

HAL RE Armchair Tube Stackable

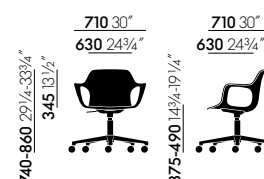

HAL RE Armchair Studio

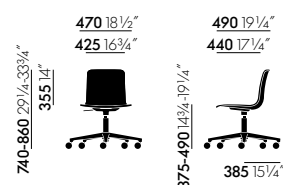

HAL RE Studio

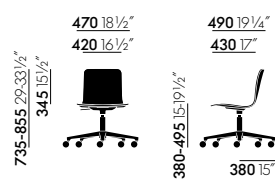

HAL Ply Studio

All measurements are pursuant to EN 1335-1:2000

More detailed information is found in the chapter 'Explanation of measurements'.

## HAL RE Armchair Wood

**Seat shell:** dyed-through, recycled polypropylene, with optional seat cushion (screwed to the seat shell).

**Base:** non-stackable wooden base in natural or dark oak. Connecting element between shell and base in die-cast aluminium, powder-coated in dim grey.

**Origin of wood:** oak (*Quercus robur*) from Western Europe and/or Poland.

## HAL RE Armchair Tube Stackable

**Seat shell:** dyed-through, recycled polypropylene.

**Base:** stackable four-legged tubular steel base, chrome-plated finish or powder-coated in basic dark. Up to 6 chairs can be stacked on the floor or on a stacking trolley. Chairs with seat cushions should not be stacked, since stacking could damage the upholstery.

**Note:** as stacking can cause scratches, we recommend the chrome version for this purpose.

## HAL RE Armchair Studio

**Seat shell:** dyed-through recycled polypropylene, with optional seat cushion (screwed to the seat shell).

**Base:** five-star base in die-cast aluminium powder-coated in basic dark. Swivel mechanism with shock-absorbing seat suspension, height-adjustable.

## HAL RE Studio

**Seat shell:** dyed-through, recycled polypropylene.

**Base:** five-star base in die-cast aluminium powder-coated in basic dark. Swivel mechanism with shock-absorbing seat suspension, height-adjustable.

## HAL Ply Studio

**Seat shell:** plywood (USA).

**Base:** five-star base in die-cast aluminium powder-coated in basic dark. Swivel mechanism with shock-absorbing seat suspension, height-adjustable.

**Glides:** colour matched to the small attachment parts for the seat shell, choice of white (except HAL Wood and HAL Ply Wood) or deep black. All bases fitted with glides for carpet; felt glides optionally available for hard floors.

HAL RE Armchair Wood	Article no.	without VAT in SEK*	with VAT in SEK*
<b>wood base, non-stacking</b>	<b>440 511 00</b>		
Base natural oak, with protective varnish, without seat upholstery	10	5.736,00	<b>7.170,00</b>
Base dark oak, with protective varnish, without seat upholstery	04	5.736,00	<b>7.170,00</b>
<b>wood base, non-stacking</b>	<b>440 512 00</b>		
Base natural oak, with protective varnish, with seat upholstery F60	10	6.824,00	<b>8.530,00</b>
Base dark oak, with protective varnish, with seat upholstery F60	04	6.824,00	<b>8.530,00</b>

HAL RE Armchair Tube Stackable	Article no.	without VAT in SEK*	with VAT in SEK*
<b>four-legged tubular steel base, stackable</b>	<b>440 513 00</b>		
Base chromed, without seat upholstery	01	4.192,00	<b>5.240,00</b>
Base basic dark without seat upholstery	30	4.192,00	<b>5.240,00</b>
<b>four-legged tubular steel base, non-stacking</b>	<b>440 514 00</b>		
Base chromed, with seat upholstery F60	01	4.968,00	<b>6.210,00</b>
Base basic dark, with seat upholstery F60	30	4.968,00	<b>6.210,00</b>

HAL RE Armchair Studio	Article no.	without VAT in SEK*	with VAT in SEK*
<b>five-star base</b>	<b>440 515 00</b>		
Base powder-coated basic dark, without seat upholstery		4.976,00	<b>6.220,00</b>
<b>five-star base</b>	<b>440 516 00</b>		
Base powder-coated basic dark, with seat upholstery F60		6.064,00	<b>7.580,00</b>

HAL RE Studio	Article no.	without VAT in SEK*	with VAT in SEK*
<b>five-star base</b>	<b>440 517 00</b>		
Base powder-coated basic dark, without seat upholstery		4.376,00	<b>5.470,00</b>
<b>five-star base</b>	<b>440 518 00</b>		
Base powder-coated basic dark, with seat upholstery F60		5.464,00	<b>6.830,00</b>

HAL Ply Studio	Article no.	without VAT in SEK*	with VAT in SEK*
<b>five-star base</b>	<b>440 229 00</b>		
Base powder-coated basic dark, seat shell natural oak, with protective varnish	01	6.360,00	<b>7.950,00</b>
Base powder-coated basic dark, seat shell dark oak, with protective varnish	02	6.360,00	<b>7.950,00</b>

Seat fabric F60	Seat shell HAL RE	Colours (Glides)	Glides	Castors
Hopsak	12 deep black RE 14 ivy RE 23 ice grey RE 29 brick RE 31 warm grey RE 35 basalt RE 85 cotton white RE 86 cardboard RE	04 white 12 deep black	04 glides for carpet 05 felt glides for hard floor	02 castors hard, braked for carpet 03 castors soft, braked for hard floor



## HAL

Jasper Morrison, 2010/2014



HAL RE Stool Medium

HAL RE Stool High

HAL Ply Stool High

HAL Ply Stool Medium

All measurements are pursuant to EN 1335-1:2000  
 More detailed information is found in the chapter 'Explanation of measurements'.

## HAL RE Stool Medium

**Seat shell:** dyed-through, recycled polypropylene, with optional seat cushion (screwed to the seat shell).

**Base:** chrome-plated tubular steel, non-stackable.

## HAL RE Stool High

**Seat shell:** dyed-through, recycled polypropylene, with optional seat cushion (screwed to the seat shell).

**Base:** chrome-plated tubular steel with anti-skid footrest, non-stacking.

## HAL Ply Stool Medium

**Seat shell:** plywood (USA).

**Base:** chrome-plated tubular steel, non-stackable.

## HAL Ply Stool High

**Seat shell:** plywood (USA).

**Base:** chrome-plated tubular steel with anti-skid footrest, non-stacking.

**Glides:** colour matched to the small attachment parts for the seat shell, choice of white (except HAL Wood and HAL Ply Wood) or deep black. All bases fitted with glides for carpet; felt glides optionally available for hard floors.

HAL RE Stool Medium	Article no.	without VAT in SEK*	with VAT in SEK*
<b>bar stool, four-legged tubular steel base, non-stacking</b>	<b>440 519 00</b>		
Base chromed, without seat upholstery		3.312,00	<b>4.140,00</b>
<b>bar stool, four-legged tubular steel base, non-stacking</b>	<b>440 520 00</b>		
Base chromed, with seat upholstery F60		4.400,00	<b>5.500,00</b>

HAL RE Stool High	Article no.	without VAT in SEK*	with VAT in SEK*
<b>bar stool, four-legged tubular steel base, non-stacking</b>	<b>440 521 00</b>		
Base chromed, without seat upholstery		3.912,00	<b>4.890,00</b>
<b>bar stool, four-legged tubular steel base, non-stacking</b>	<b>440 522 00</b>		
Base chromed, with seat upholstery F60		5.000,00	<b>6.250,00</b>

HAL Ply Stool Medium	Article no.	without VAT in SEK*	with VAT in SEK*
<b>bar stool, four-legged tubular steel base, non-stacking</b>	<b>440 224 00</b>		
Seat shell natural oak, with protective varnish	01	5.296,00	<b>6.620,00</b>
Seat shell dark oak, with protective varnish	02	5.296,00	<b>6.620,00</b>

HAL Ply Stool High	Article no.	without VAT in SEK*	with VAT in SEK*
<b>bar stool, four-legged tubular steel base, non-stacking</b>	<b>440 223 00</b>		
Seat shell natural oak, with protective varnish	01	5.896,00	<b>7.370,00</b>
Seat shell dark oak, with protective varnish	02	5.896,00	<b>7.370,00</b>

Seat fabric F60	Seat shell HAL RE	Colours (Glides)	Glides
Hopsak	12 deep black RE 14 ivy RE 23 ice grey RE 29 brick RE 31 warm grey RE 35 basalt RE 85 cotton white RE 86 cardboard RE	04 white 12 deep black	04 glides for carpet 05 felt glides for hard floor

## HAL

Jasper Morrison, 2010/2014

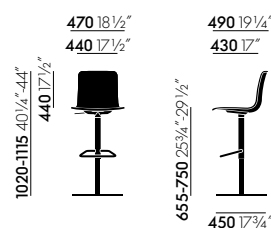

HAL RE Barstool

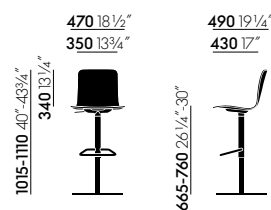

HAL Ply Barstool

All measurements are pursuant to EN 1335-1:2000  
More detailed information is found in the chapter 'Explanation of measurements'.

**HAL RE Barstool**

**Seat shell:** dyed-through recycled polypropylene, swivel mechanism, with optional seat cushion (screwed to the seat shell).

**Base:** height-adjustable tubular steel pedestal, gas spring powder-coated in basic dark, column sleeve and footrest in chrome-plated tubular steel with anti-skid surface. Seat shell and base connection in die-cast aluminium, powder-coated in dim grey. Steel base plate with brushed stainless steel cover (matt); felt bottom.

**HAL Ply Barstool**

**Seat shell:** plywood (USA); swivel mount.

**Base:** height-adjustable tubular steel pedestal, gas spring powder-coated in basic dark, column sleeve and footrest in chrome-plated tubular steel with anti-skid surface. Connecting element between shell and base in die-cast aluminium, powder-coated in dim grey. Steel base plate with brushed stainless steel cover (matt); felt bottom.

**HAL RE Barstool**

	Article no.	without VAT in SEK*	with VAT in SEK*
<b>Height-adjustable bar stool</b>	<b>440 523 00</b>		
Tubular steel base, powder-coated basic dark, without seat upholstery		6.664,00	<b>8.330,00</b>
<b>Height-adjustable bar stool</b>	<b>440 524 00</b>		
Tubular steel base, powder-coated basic dark, with seat upholstery F60		7.752,00	<b>9.690,00</b>

**HAL Ply Barstool**

	Article no.	without VAT in SEK*	with VAT in SEK*
<b>Height-adjustable bar stool</b>	<b>440 227 00</b>		
Tubular steel base, powder-coated in basic dark			
Seat shell natural oak, with protective varnish	01	8.648,00	<b>10.810,00</b>
Seat shell dark oak, with protective varnish	02	8.648,00	<b>10.810,00</b>

**Seat fabric F60****Seat shell HAL RE**

Hopsak	12 deep black RE
	14 ivy RE
	23 ice grey RE
	29 brick RE
	31 warm grey RE
	35 basalt RE
	85 cotton white RE
	86 cardboard RE

## HAL

Jasper Morrison, 2010/2014

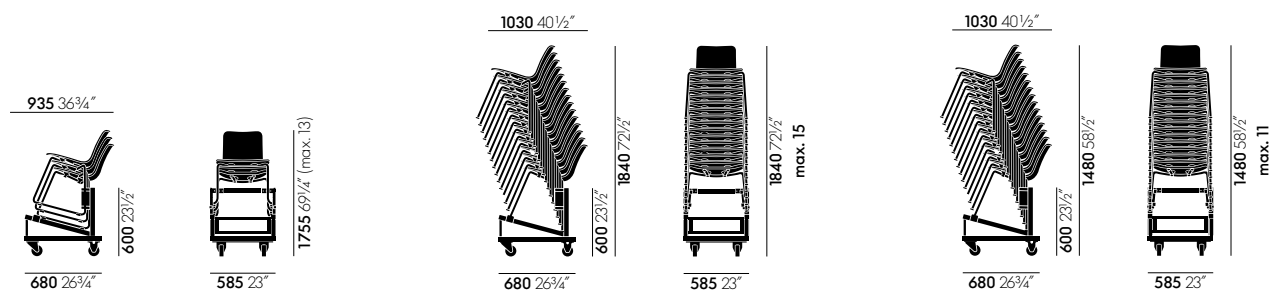

HAL RE Sledge

HAL RE Tube Stackable

HAL Ply Tube Stackable

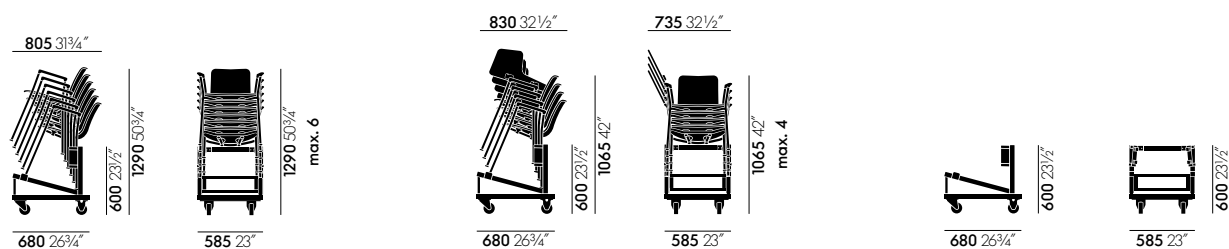

HAL RE Tube Armrest

HAL RE Tube Writing Tablet

HAL Stacking dolly

All measurements are pursuant to EN 1335-1:2000

More detailed information is found in the chapter 'Explanation of measurements'.

### HAL Stacking Trolley

HAL Stacking Trolley is suitable for use with all stackable HAL models, with the exception of HAL Soft Tube stackable.

### HAL seat cover

The fabric covers for the seat shells of HAL and HAL Ply provide enhanced comfort. They are available in various colours and can be easily attached and removed.

**HAL seat cover:** 100% polyester/polyurethane; two reverse flaps fit over top of backrest and front of seat. Available in Plano fabric in predefined colours (see Price List supplement for upholstery materials). Additional colours in the Plano collection can be selected for orders of 6 or more seat covers.

### HAL row connector

The HAL row connector is a linking element in two sizes: 100 mm for a smaller and 180 mm for a larger distance between the chairs. The number clips of the linking elements for the .03 also match the new HAL linking element.

For the following HAL chairs, the linking elements can be used in both sizes:

- HAL RE Tube Stackable
- HAL Ply Tube Stackable
- HAL RE Tube Armrest

For the following HAL chairs, only the linking element of 180 mm can be used:

- HAL RE Armchair Tube Stackable
- HAL RE Tube Writing Tablet

# HAL

Jasper Morrison, 2010/2014

**vitra.**

<b>HAL Stacking Trolley</b>		Article no.	without VAT in SEK*	with VAT in SEK*
<b>Trolley suited for all stackable HAL chair models</b>		<b>440 219 00</b>	12.904,00	<b>16.130,00</b>
<b>HAL Seat Cover</b>		Article no.	without VAT in SEK*	with VAT in SEK*
		<b>440 209 00</b>		
Plano			1.312,00	<b>1.640,00</b>
<b>HAL Ply seat cover</b>		Article no.	without VAT in SEK*	with VAT in SEK*
		<b>440 225 00</b>		
Plano			1.312,00	<b>1.640,00</b>
<b>HAL row connector</b>		Article no.	without VAT in SEK*	with VAT in SEK*
<b>row connector, 100 mm, set of 10</b>	plastic, basic dark	<b>442 045 00</b>	616,00	<b>770,00</b>
<b>row connector, 180 mm, set of 10</b>	plastic, basic dark	<b>442 046 00</b>	696,00	<b>870,00</b>
<b>Number clips</b>		Article no.	without VAT in SEK*	with VAT in SEK*
<b>Set of 10 items</b>		<b>442 044 00</b>		
		01	176,00	<b>220,00</b>

## Seat cover, Plano

05 cream white/sierra grey  
07 orange  
12 light grey/ice blue  
54 brown  
69 dark grey  
84 poppy red/champagne

# ID Visitor

Antonio Citterio, 2021



ID Visitor Air



ID Visitor Mesh

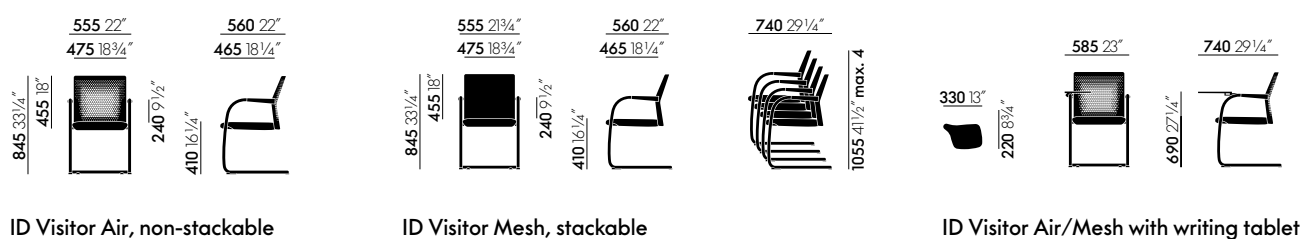

ID Visitor Air, non-stackable

ID Visitor Mesh, stackable

ID Visitor Air/Mesh with writing tablet

All measurements are pursuant to EN 1335-1:2000  
More detailed information is found in the chapter 'Explanation of measurements'.

## ID Visitor Air

**Backrest:** perforated plastic backrest in basic dark or soft grey, unupholstered. Armrests made of polypropylene in basic dark or dim grey.

**Seat cushion:** polyurethane foam or optional PU-foam-free padding (F). Seat cover in fabric or leather.

**Base:** tubular steel cantilever base, in chrome or powder-coated in basic dark or soft grey. Can be stacked (max. 4 chairs).

**Note:** as stacking can cause scratches, we recommend the chrome version for this purpose. In the stackable version, the seat cover is in basic dark (with armrests in basic dark) or soft grey (with armrests in dim grey).

**Optional accessory:** a multipurpose folding desk tablet in black plastic is available for the version in chrome.

## ID Visitor Mesh

**Backrest:** plastic backrest covered with 3D spacer fabric; double seam around the edge. Armrests made of polypropylene in basic dark or dim grey.

**Seat cushion:** polyurethane foam or optional PU-foam-free padding (F). Seat cover in woven fabric or 3D spacer fabric.

**Base:** tubular steel cantilever base, in chrome or powder-coated in basic dark or soft grey. Can be stacked (max. 4 chairs).

**Note:** as stacking can cause scratches, we recommend the chrome version for this purpose. In the stackable version, the seat cover is in basic dark (with armrests in basic dark) or soft grey (with armrests in dim grey).

**Optional accessory:** a multipurpose folding desk tablet in black plastic is available for the version in chrome.

# ID Visitor

## Antonio Citterio, 2021

vitra.

ID Visitor Air	Article no.	without VAT in SEK*	with VAT in SEK*
	<b>431 500 00</b>		
Seat Silk Mesh		4.064,00	<b>5.080,00</b>
Seat fabric F30		4.064,00	<b>5.080,00</b>
Seat fabric F40		4.112,00	<b>5.140,00</b>
Seat fabric F60		4.304,00	<b>5.380,00</b>
Seat leather L20		6.592,00	<b>8.240,00</b>
<b>Surcharges upholstery</b>			
standard	01	0,00	<b>0,00</b>
polyurethane foam free (F) (in Plano, Silk Mesh or Reflect)	02	568,00	<b>710,00</b>
<b>Surcharges base</b>			
powder-coated, non-stackable	11	0,00	<b>0,00</b>
chromed, non-stackable	12	616,00	<b>770,00</b>
powder-coated, stackable	13	0,00	<b>0,00</b>
chromed, stackable	14	616,00	<b>770,00</b>

ID Visitor Mesh	Article no.	without VAT in SEK*	with VAT in SEK*
	<b>431 501 00</b>		
Backrest Diamond Mesh, seat Silk Mesh		4.728,00	<b>5.910,00</b>
Backrest Diamond Mesh, seat fabric F30		4.728,00	<b>5.910,00</b>
Backrest Diamond Mesh, seat fabric F40		4.792,00	<b>5.990,00</b>
Backrest Diamond Mesh, seat fabric F60		4.976,00	<b>6.220,00</b>
<b>Surcharges upholstery</b>			
standard	01	0,00	<b>0,00</b>
polyurethane foam free (F) (in Plano, Silk Mesh or Reflect)	02	568,00	<b>710,00</b>
<b>Surcharges base</b>			
powder-coated, non-stackable	11	0,00	<b>0,00</b>
chromed, non-stackable	12	616,00	<b>770,00</b>
powder-coated, stackable	13	0,00	<b>0,00</b>
chromed, stackable	14	616,00	<b>770,00</b>

Universal writing tablet	Article no.	without VAT in SEK*	with VAT in SEK*	
<b>Right side</b>	black plastic	<b>416 242 00</b>	2.040,00	<b>2.550,00</b>

Fabric F30	Fabric F40	Fabric F60	Leather L20	Backrest ID Visitor Air	Armrests	Base coated	Glides
. Plano	. Laser RE . Reflect	. Volo	. Leather	30 basic dark 53 soft grey	21 dim grey 30 basic dark	30 basic dark powder-coated (textured) 53 soft grey powder-coated (textured)	04 glides for carpet 05 felt glides for hard floor

# ID Visitor

Antonio Citterio, 2021



ID Visitor Soft

ID Visitor Trim

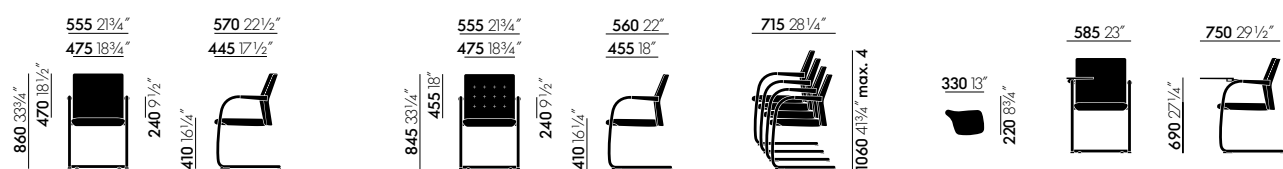

ID Visitor Soft, non-stackable

ID Visitor Trim, stackable

ID Visitor Soft/Trim with writing tablet

All measurements are pursuant to EN 1335-1:2000  
More detailed information is found in the chapter 'Explanation of measurements'.

## ID Visitor Soft

**Backrest:** plastic backrest with soft polyurethane or polyurethane-free padding; fabric or leather cover. The version in leather has a double seam in the centre. Armrests made of polypropylene in basic dark or dim grey.

**Seat cushion:** polyurethane foam or optional PU-foam-free padding (F). Seat and back covers in fabric or leather.

**Base:** tubular steel cantilever base, in chrome or powder-coated in basic dark or soft grey. Can be stacked (max. 4 chairs).

**Note:** as stacking can cause scratches, we recommend the chrome version for this purpose. In the stackable version, the seat cover is in basic dark (with armrests in basic dark) or soft grey (with armrests in dim grey).

**Optional accessory:** a multipurpose folding desk tablet in black plastic is available for the version in chrome.

## ID Visitor Trim

**Backrest:** plastic backrest with polyurethane or polyurethane-free padding; fabric cover with double seam around the edge. Armrests made of polypropylene in basic dark or dim grey.

**Seat cushion:** polyurethane foam or optional PU-foam-free padding (F). Seat and back covers in fabric.

**Base:** tubular steel cantilever base, in chrome or powder-coated in basic dark or soft grey. Can be stacked (max. 4 chairs).

**Note:** as stacking can cause scratches, we recommend the chrome version for this purpose. In the stackable version, the seat cover is in basic dark (with armrests in basic dark) or soft grey (with armrests in dim grey).

**Optional accessory:** a multipurpose folding desk tablet in black plastic is available for the version in chrome.



# ID Visitor

Antonio Citterio, 2021

## ID Visitor Soft

	Article no.	without VAT in SEK*	with VAT in SEK*
	<b>431 502 00</b>		
Backrest and seat fabric F30		5.392,00	<b>6.740,00</b>
Backrest and seat fabric F40		5.544,00	<b>6.930,00</b>
Backrest and seat fabric F60		5.936,00	<b>7.420,00</b>
Backrest and seat leather L20		10.080,00	<b>12.600,00</b>
<b>Surcharges upholstery</b>			
standard	01	0,00	<b>0,00</b>
polyurethane foam free (F) (in Plano, Silk Mesh or Reflect)	02	928,00	<b>1.160,00</b>
<b>Surcharges base</b>			
powder-coated, non-stackable	11	0,00	<b>0,00</b>
chromed, non-stackable	12	616,00	<b>770,00</b>
powder-coated, stackable	13	0,00	<b>0,00</b>
chromed, stackable	14	616,00	<b>770,00</b>

## ID Visitor Trim

	Article no.	without VAT in SEK*	with VAT in SEK*
	<b>431 503 00</b>		
Backrest and seat fabric F30		5.392,00	<b>6.740,00</b>
Backrest and seat fabric F40		5.544,00	<b>6.930,00</b>
Backrest and seat fabric F60		5.936,00	<b>7.420,00</b>
<b>Surcharges upholstery</b>			
standard	01	0,00	<b>0,00</b>
polyurethane foam free (F) (in Plano, Silk Mesh or Reflect)	02	928,00	<b>1.160,00</b>
<b>Surcharges base</b>			
powder-coated, non-stackable	11	0,00	<b>0,00</b>
chromed, non-stackable	12	616,00	<b>770,00</b>
powder-coated, stackable	13	0,00	<b>0,00</b>
chromed, stackable	14	616,00	<b>770,00</b>

## Universal writing tablet

		Article no.	without VAT in SEK*	with VAT in SEK*
<b>Right side</b>	black plastic	<b>416 242 00</b>	2.040,00	<b>2.550,00</b>

Fabric F30	Fabric F40	Fabric F60	Leather L20	Armrests	Base coated	Glides
. Plano	. Laser RE . Reflect	. Volo	. Leather	21 dim grey 30 basic dark	30 basic dark powder-coated (textured) 53 soft grey powder-coated (textured)	04 glides for carpet 05 felt glides for hard floor

# Landi Chair

Hans Coray, 1938



All measurements are pursuant to EN 1335-1:2000  
More detailed information is found in the chapter 'Explanation of measurements'.

**Seat shell:** seat shell in pressed aluminium sheeting with 91 punched holes, matte anodised surface.

**Base:** armrests and legs from bent aluminium profiles, with welded aluminium cross braces, matt anodised surface.

**Glides:** glides in light grey injection-moulded TPE.

**Applications:** ideal for outdoor use in both private and public spaces, such as home patios or balconies, restaurant terraces, open-air cafés etc.

**Note:** as in the original design, the Landi Chair can be stacked up to 6 units high. Vitra's re-edition of the classic stays true to the original while making the most of the latest technical possibilities. The anodised aluminium surface of the chair is durable and weather-resistant but may develop signs of wear and tear if the chairs are stacked.

## Landi Chair

	Article no.	without VAT in SEK*	with VAT in SEK*
aluminium anodized matt	440 270 00	8.080,00	10.100,00

# Lobby Chair

Charles & Ray Eames, 1960



ES 105



ES 108

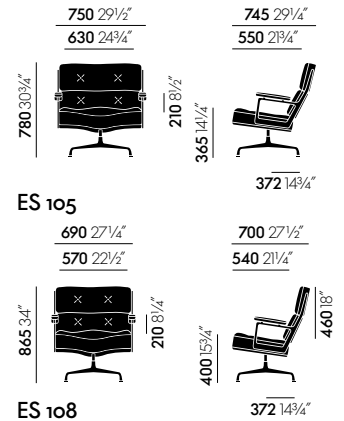

All measurements are pursuant to EN 1335-1:2000  
 More detailed information is found in the chapter 'Explanation of measurements'.

## ES 105

**Furniture type:** lounge chair

**Backrest and seat:** side frames in chrome-plated die-cast aluminium. Cushion elements covered in leather. Fixed seat height, swivel seat.

**Armrests:** upholstered in leather.

**Base:** four-star base in chrome-plated die-cast aluminium.

## ES 108

**Furniture type:** conference chair

**Backrest and seat:** side frames in chrome-plated die-cast aluminium. Cushion elements covered in leather. Fixed seat height, swivel seat.

**Armrests:** upholstered in leather.

**Base:** four-star base in chrome-plated die-cast aluminium.

## ES 105

	Article no.	without VAT in SEK*	with VAT in SEK*
<b>swivel</b>	<b>412 078 00</b>		
with armrests			
Leather L20		67.200,00	<b>84.000,00</b>
Leather L50		72.400,00	<b>90.500,00</b>

## ES 108

	Article no.	without VAT in SEK*	with VAT in SEK*
<b>swivel</b>	<b>412 079 00</b>		
with armrests			
Leather L20		65.760,00	<b>82.200,00</b>
Leather L50		70.720,00	<b>88.400,00</b>

### Leather L20

Leather

### Leather L50

Leather Premium F

### Glides

04 glides for carpet  
 05 felt glides for hard floor

# Moca

Jasper Morrison, 2020

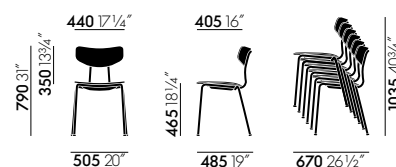

All measurements are pursuant to EN 1335-1:2000  
 More detailed information is found in the chapter 'Explanation of measurements'.

**Seat and backrest:** moulded plywood veneer in natural oak (Germany) or dark-stained oak (USA), protective natural lacquer finish.

**Base:** stackable metal base (up to 6 chairs), chrome-plated or powder-coated finish.

## Moca

	Article no.	without VAT in SEK*	with VAT in SEK*
	<b>210 649 00</b>		
Oak, with protective varnish		4.560,00	<b>5.700,00</b>

### Backrest and seat

- 04 dark oak, with protective varnish
- 10 natural oak, with protective varnish

### Base

- 01 chrome
- 30 basic dark powder-coated (textured)

### Glides

- 04 glides for carpet
- 05 felt glides for hard floor

# MedaSlim

Alberto Meda, 2004



MedaSlim without armrests, stacking



MedaSlim without armrests, stacking



MedaSlim with armrests, stacking

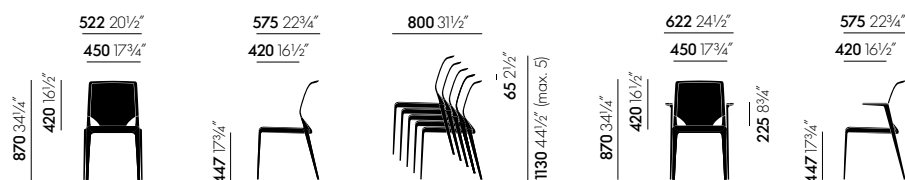

All measurements are pursuant to EN 1335-1:2000  
 More detailed information is found in the chapter 'Explanation of measurements'.

**Backrest:** netweave sling cover (Netline).

**Seat upholstery:** polyurethane foam padding with fabric or leather cover.

**Armrests:** die-cast aluminium with polished or chrome-plated finish or powder-coated in basic dark.

**Base and backrest:** backrest frame, front legs and seat shell moulded from a single piece of fibreglass-reinforced polyamide (basic dark). Back legs in aluminium with polished or chrome-plated finish or powder-coated in basic dark.

**Note:** only MedaSlim chairs with chrome-plated legs are suitable for stacking (up to 5 chairs). The polished and powder-coated versions should not be stacked as this could scratch the surface.

# MedaSlim

Alberto Meda, 2004

**vitra.**

<b>MedaSlim</b>	Article no.	without VAT in SEK*	with VAT in SEK*
<b>without armrests</b>	<b>417 301 00</b>		
Seat fabric F20, backrest Netline		5.488,00	<b>6.860,00</b>
Seat fabric F30, backrest Netline		5.600,00	<b>7.000,00</b>
Seat leather L20, backrest Netline		8.136,00	<b>10.170,00</b>
<b>Surcharges base</b>			
coated	0	0,00	<b>0,00</b>
polished	1	528,00	<b>660,00</b>
chromed (stackable)	2	1.296,00	<b>1.620,00</b>
<b>with armrests</b>	<b>417 302 00</b>		
Seat fabric F20, backrest Netline		6.384,00	<b>7.980,00</b>
Seat fabric F30, backrest Netline		6.472,00	<b>8.090,00</b>
Seat leather L20, backrest Netline		9.032,00	<b>11.290,00</b>
<b>Surcharges base</b>			
coated	0	0,00	<b>0,00</b>
polished	1	528,00	<b>660,00</b>
chromed (stackable)	2	1.296,00	<b>1.620,00</b>

<b>Number clips</b>	Article no.	without VAT in SEK*	with VAT in SEK*
<b>Set of 10 items</b>	<b>442 044 00</b>		
	01	176,00	<b>220,00</b>

Fabric F20	Fabric F30	Leather L20	Glides	Number clips
. Nova	. Plano	. Leather	04 glides for carpet 05 felt glides for hard floor	01 numbers (1 set 1-10) 02 numbers (1 set 11-20) 03 numbers (1 set 21-30) 04 numbers (1 set 31-40) 05 numbers (1 set 41-50)

# Organic Chair

Charles Eames & Eero Saarinen, 1940

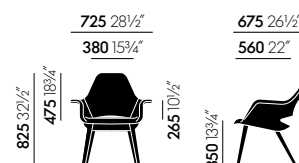

## Organic Chair

All measurements are pursuant to EN 1335-1:2000  
More detailed information is found in the chapter 'Explanation of measurements'.

**Seat shell:** laminated.

**Upholstery:** polyurethane foam with fabric cover.

**Legs:** black ash or natural oak.

**Glides:** fitted with plastic glides for carpet, felt glides for hard floors additionally included.

**Origin of wood:** oak (*Quercus robur*) and ash (*Fraxinus excelsior*) from Western Europe and/or Poland.

## Organic Chair

	Article no.	without VAT in SEK*	with VAT in SEK*
	<b>210 010 00</b>		
Fabric F60		18.800,00	<b>23.500,00</b>
Fabric F80		19.600,00	<b>24.500,00</b>
Fabric F100		20.320,00	<b>25.400,00</b>
Fabric F120		21.120,00	<b>26.400,00</b>

### Fabric F60

. Hopsak

### Fabric F80

. Cosy 2

### Fabric F100

. Tonus

### Fabric F120

. Credo

### Legs

10 natural oak, with protective varnish  
68 black ash

# Organic Conference

Charles Eames & Eero Saarinen, 1940

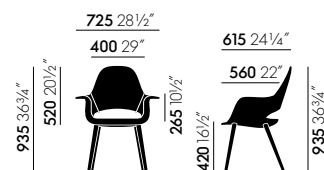

## Organic Conference

All measurements are pursuant to EN 1335-1:2000  
More detailed information is found in the chapter 'Explanation of measurements'.

**Seat shell:** laminated.

**Upholstery:** polyurethane foam with fabric cover.

**Legs:** black ash or natural oak.

**Glides:** fitted with plastic glides for carpet, felt glides for hard floors additionally included.

**Origin of wood:** oak (*Quercus robur*) and ash (*Fraxinus excelsior*) from Western Europe and/or Poland.

## Organic Conference

	Article no.	without VAT in SEK*	with VAT in SEK*
	<b>210 011 00</b>		
Fabric F60		18.800,00	<b>23.500,00</b>
Fabric F80		19.600,00	<b>24.500,00</b>
Fabric F100		20.320,00	<b>25.400,00</b>
Fabric F120		21.120,00	<b>26.400,00</b>

### Fabric F60

· Hopsak

### Fabric F80

· Cosy 2

### Fabric F100

· Tonus

### Fabric F120

· Credo

### Legs

10 natural oak, with protective varnish  
68 black ash



# Panton Chair Classic

Verner Panton, 1959

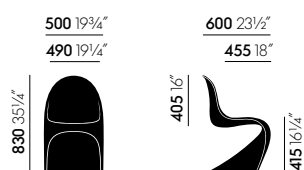

All measurements are pursuant to EN 1335-1:2000  
More detailed information is found in the chapter 'Explanation of measurements'.

**Shell:** rigid polyurethane foam.

**Surface:** glossy lacquer finish.

## Panton Chair Classic

	Article no.	without VAT in SEK*	with VAT in SEK*
<b>Polyurethane</b>	<b>406 001 00</b>		
lacquered	00	14.080,00	<b>17.600,00</b>

### Seat shell

11 white  
12 black  
15 red  
42 green

# Panton Chair

Verner Panton, 1999

**vitra.**

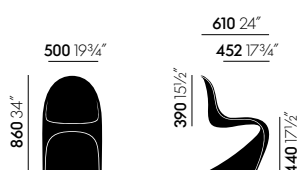

All measurements are pursuant to EN 1335-1:2000  
More detailed information is found in the chapter 'Explanation of measurements'.

**Back, seat and base:** dyed-through polypropylene, 100% recyclable. Matt finish. Suited for outdoor use.

**Note:** special additives retard the fading of colours due to UV radiation. However, if the chair is exposed to sunlight for prolonged periods, the colour may change over time. We recommend limited exposure to sunlight.

## Panton Chair (new height)

	Article no.	without VAT in SEK*	with VAT in SEK*
<b>polypropylene</b>	<b>440 035 00</b>		
		3.032,00	<b>3.790,00</b>

 Quickship

## Panton Chair

	Article no.	without VAT in SEK*	with VAT in SEK*
<b>Chair in white</b>	<b>QS4 003 5A</b>	3.032,00	<b>3.790,00</b>

### Seat shell

- 04 white
- 12 deep black
- 28 classic red
- 37 glacier blue
- 41 pale rose
- 57 soft mint
- 98 bordeaux

# Panton Junior

Verner Panton, 1959/1960

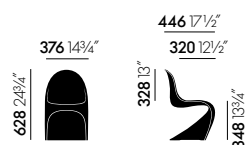

All measurements are pursuant to EN 1335-1:2000  
More detailed information is found in the chapter 'Explanation of measurements'.

**Back, seat and base:** dyed-through polypropylene. Matt finish. Suited for outdoor use.

**Note:** special additives retard the fading of colours due to UV radiation. However, if the chair is exposed to sunlight for prolonged periods, the colour may change over time. We recommend limited exposure to sunlight.

**Safety information:** chair suitable for children aged 3 to 10 and for max. 34 kg (74 lbs). For children under the age of 3, there is an increased risk of a fall or of the chair tipping over. Do not let your child climb on the chair. Always make sure the chair is used in a safe place. A chair standing by a window, for example, may result in a child falling from a dangerous height.



**Panton Junior**  
classic red  
**210 196 18**  
SEK\* 1.680,00 / **2.100,00**



**Panton Junior**  
soft mint  
**210 196 05**  
SEK\* 1.680,00 / **2.100,00**



**Panton Junior**  
sea blue  
**210 196 06**  
SEK\* 1.680,00 / **2.100,00**



**Panton Junior**  
white  
**210 196 04**  
SEK\* 1.680,00 / **2.100,00**



**Panton Junior**  
pale rose  
**210 196 07**  
SEK\* 1.680,00 / **2.100,00**



**Panton Junior**  
golden yellow  
**210 196 08**  
SEK\* 1.680,00 / **2.100,00**

# Plywood Group

## Charles & Ray Eames, 1945/1946

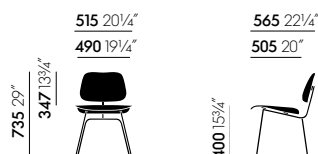

DCM



DCW

All measurements are pursuant to EN 1335-1:2000  
More detailed information is found in the chapter 'Explanation of measurements'.

### DCM = Dining Chair Metal

**Back/seat:** moulded plywood with face veneer in ash or walnut.

**Base:** tubular steel, chrome-plated or powder-coated. Seat and backrest attached to the base with shock mounts (bonded rubber and metal connectors).

### DCW = Dining Chair Wood

**Back/seat:** moulded plywood with face veneer in ash or walnut.

**Base:** moulded plywood with same face veneer as the back and seat. Seat and backrest attached to the base with shock mounts (bonded rubber and metal connectors).

DCM	Article no.	without VAT in SEK*	with VAT in SEK*
	<b>210 546 00</b>		
natural ash (new)	64	9.120,00	<b>11.400,00</b>
black ash	68	9.120,00	<b>11.400,00</b>
black-pigmented walnut	45	10.080,00	<b>12.600,00</b>

DCW	Article no.	without VAT in SEK*	with VAT in SEK*
	<b>210 547 00</b>		
natural ash (new)	64	15.200,00	<b>19.000,00</b>
black ash	68	15.200,00	<b>19.000,00</b>
black-pigmented walnut	45	17.520,00	<b>21.900,00</b>

#### Base (DCM, LCM)

01 chrome  
30 basic dark powder-coated (smooth)

#### Glides (DCM, LCM)

04 glides for carpet  
05 felt glides for hard floor

# Plywood Group

## Charles & Ray Eames, 1945/1946

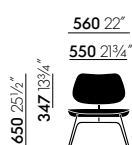

LCM

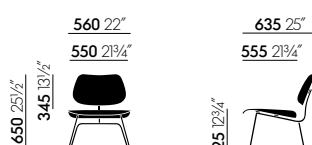

LCM Calf's Skin

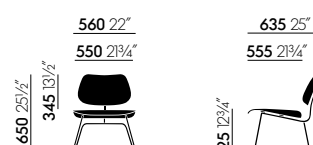

LCM Leather

All measurements are pursuant to EN 1335-1:2000  
More detailed information is found in the chapter 'Explanation of measurements'.

### LCM = Lounge Chair Metal

**Back/seat:** moulded plywood with face veneer in ash or walnut.

**Upholstery:** thin foam padding, covered in leather (LCW Leather) or calfskin hide (LCW Calf's Skin).

**Base:** tubular steel, chrome-plated or powder-coated. Seat and backrest attached to the base with shock mounts (bonded rubber and metal connectors).

### LCM

	Article no.	without VAT in SEK*	with VAT in SEK*
			<b>210 548 00</b>
natural ash (new)	64	9.600,00	<b>12.000,00</b>
black ash	68	9.600,00	<b>12.000,00</b>
black-pigmented walnut	45	10.480,00	<b>13.100,00</b>

### LCM Calf's Skin

	Article no.	without VAT in SEK*	with VAT in SEK*
			<b>210 549 00</b>
natural ash (new), hide brown / white	64	21.360,00	<b>26.700,00</b>
black ash, hide black / white	68	21.360,00	<b>26.700,00</b>

### LCM Leather

	Article no.	without VAT in SEK*	with VAT in SEK*
			<b>210 550 00</b>
natural ash (new), leather nero	64	19.120,00	<b>23.900,00</b>
black ash, leather nero	68	19.120,00	<b>23.900,00</b>
black-pigmented walnut, leather nero	45	20.000,00	<b>25.000,00</b>

#### Base (DCM, LCM)

01 chrome  
30 basic dark powder-coated (smooth)

#### Glides (DCM, LCM)

04 glides for carpet  
05 felt glides for hard floor

# Plywood Group

## Charles & Ray Eames, 1945/1946



LCW



LCW Calf's Skin



LCW Leather

All measurements are pursuant to EN 1335-1:2000  
More detailed information is found in the chapter 'Explanation of measurements'.

### LCW = Lounge Chair Wood

**Back/seat:** moulded plywood with face veneer in ash or walnut.

**Upholstery:** thin foam padding, covered in leather (LCW Leather) or calfskin hide (LCW Calf's Skin).

**Base:** moulded plywood with same face veneer as the back and seat. Seat and backrest attached to the base with shock mounts (bonded rubber and metal connectors).

### LCW

	Article no.	without VAT in SEK*	with VAT in SEK*
			<b>210 551 00</b>
natural ash	64	15.200,00	<b>19.000,00</b>
black ash	68	15.200,00	<b>19.000,00</b>
black-pigmented walnut	45	17.520,00	<b>21.900,00</b>

### LCW Calf's Skin

	Article no.	without VAT in SEK*	with VAT in SEK*
			<b>210 552 00</b>
natural ash (new), hide brown / white	64	27.360,00	<b>34.200,00</b>
black ash, hide black / white	68	27.360,00	<b>34.200,00</b>

### LCW Leather

	Article no.	without VAT in SEK*	with VAT in SEK*
			<b>210 553 00</b>
natural ash (new), leather nero	64	25.120,00	<b>31.400,00</b>
black ash, leather nero	68	25.120,00	<b>31.400,00</b>
black-pigmented walnut, leather nero	45	27.520,00	<b>34.400,00</b>

# Softshell Chair

Ronan & Erwan Bouroullec, 2008

vitra.

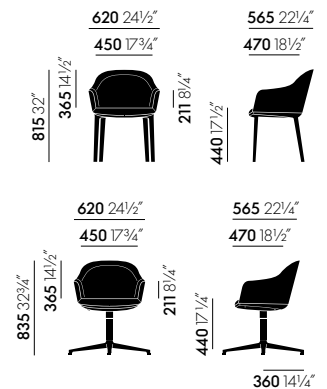

Softshell Chair four-legged base

Softshell Chair four-star base

All measurements are pursuant to EN 1335-1:2000  
More detailed information is found in the chapter 'Explanation of measurements'.

**Backrest and seat:** flexible upper backrest shell. Seat and backrest shell in fibreglass-reinforced polyamide. Seat and backrest upholstery in polyurethane foam. Armrests are integrated in the seat shell. Version in Laser fabric and in leather with two seams along the sides of the backrest.

**Four-legged base:** polyamide in basic dark with glides.

**Backrest and seat:** flexible upper backrest shell. Seat and backrest shell in fibreglass-reinforced polyamide. Seat and backrest upholstery in polyurethane foam. Armrests are integrated in the seat shell. With two seams along the sides of the backrest.

**Four-star base:** aluminium powder-coated in basic dark or with polished finish (swivel function with comfortable seat depth suspension).

## Softshell Chair

	Article no.	without VAT in SEK*	with VAT in SEK*
<b>Four-legged base</b>	<b>423 006 00</b>		
Fabric F30		7.160,00	<b>8.950,00</b>
Fabric F40		7.480,00	<b>9.350,00</b>
Fabric F60		7.920,00	<b>9.900,00</b>
Fabric F80		8.400,00	<b>10.500,00</b>
Fabric F100		8.880,00	<b>11.100,00</b>
Fabric F120		9.520,00	<b>11.900,00</b>
Leather L20		15.040,00	<b>18.800,00</b>
Leather L50		18.720,00	<b>23.400,00</b>

## Softshell Chair

	Article no.	without VAT in SEK*	with VAT in SEK*
<b>Four-star base</b>	<b>423 007 00</b>		
Fabric F30		10.080,00	<b>12.600,00</b>
Fabric F40		10.240,00	<b>12.800,00</b>
Fabric F60		10.720,00	<b>13.400,00</b>
Fabric F80		11.280,00	<b>14.100,00</b>
Fabric F100		12.000,00	<b>15.000,00</b>
Fabric F120		12.560,00	<b>15.700,00</b>
Leather L20		17.680,00	<b>22.100,00</b>
Leather L50		21.440,00	<b>26.800,00</b>
<b>Surcharges base</b>			
aluminium base, powder-coated in basic dark	2	0,00	<b>0,00</b>
aluminium base, polished	3	456,00	<b>570,00</b>

Fabric F30	Fabric F40	Fabric F60	Fabric F80	Fabric F100	Fabric F120	Leather L20	Leather L50	Glides
Plano	Laser RE	Twill Volo	Dumet Linho Tress	Aura Reed	Credo	Leather	Leather Premium F	04 glides for carpet 05 felt glides for hard floor

# Softshell Chair

Ronan & Erwan Bouroullec, 2008

vitra.

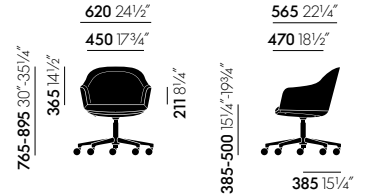

All measurements are pursuant to EN 1335-1:2000  
More detailed information is found in the chapter 'Explanation of measurements'.

**Backrest and seat:** flexible upper backrest shell. Seat and backrest shell in fibreglass-reinforced polyamide. Seat and backrest upholstery in polyurethane foam. Armrests are integrated in the seat shell. With two seams along the sides of the backrest.

**Five-star base:** powder-coated (basic dark) or polished aluminium.

## Softshell Chair

	Article no.	without VAT in SEK*	with VAT in SEK*
<b>Five-star base</b>	<b>423 008 00</b>		
Fabric F30		10.080,00	<b>12.600,00</b>
Fabric F40		10.240,00	<b>12.800,00</b>
Fabric F60		10.720,00	<b>13.400,00</b>
Fabric F80		11.280,00	<b>14.100,00</b>
Fabric F100		12.000,00	<b>15.000,00</b>
Fabric F120		12.560,00	<b>15.700,00</b>
Leather L20		17.680,00	<b>22.100,00</b>
Leather L50		21.440,00	<b>26.800,00</b>
<b>Surcharges base</b>			
aluminium base, powder-coated in basic dark	2	0,00	<b>0,00</b>
aluminium base, polished	3	456,00	<b>570,00</b>

Fabric F30	Fabric F40	Fabric F60	Fabric F80	Fabric F100	Fabric F120	Leather L20	Leather L50	Castors
Plano	Laser RE	Twill Volo	Dumet Linho Tress	Aura Reed	Credo	Leather	Leather Premium F	02 castors hard, braked for carpet 03 castors soft, braked for hard floor



# Softshell Side Chair

Ronan & Erwan Bouroullec, 2017

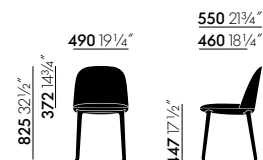

All measurements are pursuant to EN 1335-1:2000  
More detailed information is found in the chapter 'Explanation of measurements'.

**Backrest and seat:** seat and backrest shell in fibreglass-reinforced polyamide, flexible upper backrest shell. Seat and backrest upholstery in polyurethane foam.

**Four-legged base:** polyamide in basic dark with glides.

## Softshell Side Chair

	Article no.	without VAT in SEK*	with VAT in SEK*
<b>Four-legged base</b>	<b>423 010 00</b>		
Fabric F30		6.072,00	<b>7.590,00</b>
Fabric F40		6.240,00	<b>7.800,00</b>
Fabric F60		6.720,00	<b>8.400,00</b>
Fabric F80		7.192,00	<b>8.990,00</b>
Fabric F100		7.512,00	<b>9.390,00</b>
Fabric F120		8.240,00	<b>10.300,00</b>
Leather L20		13.840,00	<b>17.300,00</b>
Leather L50		16.960,00	<b>21.200,00</b>

Fabric F30	Fabric F40	Fabric F60	Fabric F80	Fabric F100	Fabric F120	Leather L20	Leather L50	Glides
Plano	Laser RE	Twill Volo	Dumet Linho Tress	Aura Reed	Credo	Leather	Leather Premium F	04 glides for carpet 05 felt glides for hard floor

# Standard

## Jean Prouvé, 1934/1950

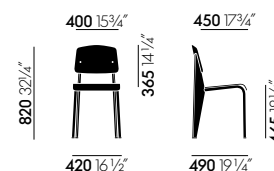

All measurements are pursuant to EN 1335-1:2000  
More detailed information is found in the chapter 'Explanation of measurements'.

**Seat and backrest:** oak (natural or dark finish) or walnut (black-pigmented finish), USA.

**Base:** bent sheet steel and tubular steel, powder-coated finish (smooth).

**Note:** the steel frame in Métal Brut has a raw irregular surface protected by a transparent powder coating.

### Standard

	Article no.	without VAT in SEK*	with VAT in SEK*
	<b>210 435 00</b>		
Seat and backrest in wood		7.752,00	<b>9.690,00</b>

#### Back and seat, veneer (Standard)

04 dark oak, with protective varnish  
10 natural oak, with protective varnish  
45 black pigmented walnut

#### Base

06 Japanese red powder-coated (smooth)  
12 deep black powder-coated (smooth)  
13 Prouvé Gris Vermeer powder-coated (smooth)  
14 Prouvé Bleu Dynastie powder-coated (smooth)  
18 Prouvé Blé Vert powder-coated (smooth)  
41 Prouvé Bleu Marcoule powder-coated (smooth)  
88 Prouvé Blanc Colombe (Ecrú) powder-coated (smooth)  
94 Prouvé Métal Brut powder-coated (transparent, smooth)

#### Glides

04 glides for carpet  
05 felt glides for hard floor

# Standard SP

Jean Prouvé, 1934/1950

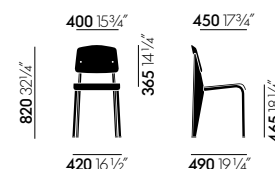

All measurements are pursuant to EN 1335-1:2000  
More detailed information is found in the chapter 'Explanation of measurements'.

**Seat and backrest:** ASA plastic (fine-textured).

**Base:** bent sheet steel and tubular steel, powder-coated finish (smooth).

**Note:** the steel frame in Métal Brut has a raw irregular surface protected by a transparent powder coating.

## Standard SP

	Article no.	without VAT in SEK*	with VAT in SEK*
	<b>210 436 00</b>		
Seat and backrest in plastic		5.352,00	<b>6.690,00</b>

### Back and seat (Standard SP)

12 deep black  
31 warm grey  
35 basalt

### Base

06 Japanese red powder-coated (smooth)  
12 deep black powder-coated (smooth)  
13 Prouvé Gris Vermeer powder-coated (smooth)  
14 Prouvé Bleu Dynastie powder-coated (smooth)  
18 Prouvé Blé Vert powder-coated (smooth)  
41 Prouvé Bleu Marcoule powder-coated (smooth)  
88 Prouvé Blanc Colombe (Ecrû) powder-coated (smooth)  
94 Prouvé Métal Brut powder-coated (transparent, smooth)

### Glides

04 glides for carpet  
05 felt glides for hard floor

# Stool-Tool

Konstantin Grcic, 2016

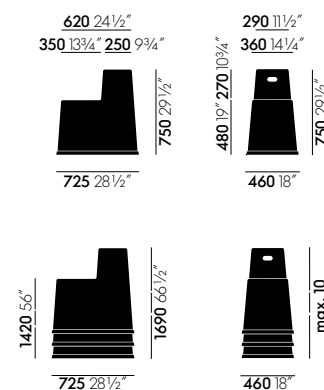

## Stool-Tool

All measurements are pursuant to EN 1335-1:2000  
 More detailed information is found in the chapter 'Explanation of measurements'.

**Stool:** polypropylene, 5.5 kg, up to 10 units can be stacked on the floor, incl. stacking protectors.

**Glides:** universal glides.

**Applications:** all colours are suited for outdoor use.

**Note:** special additives retard the fading of colours due to UV radiation. However, if Stool-Tool is exposed to sunlight for prolonged periods, the colour may change over time. For this reason, limited exposure to sunlight is advisable.

## Stool-Tool

	Article no.	without VAT in SEK*	with VAT in SEK*
stackable	440 396 00	2.800,00	3.500,00

## Stool

- 03 poppy red
- 24 light grey
- 76 industrial green

# Tabouret Haut

Jean Prouvé, 1942

vitra.



All measurements are pursuant to EN 1335-1:2000  
More detailed information is found in the chapter 'Explanation of measurements'.

**Seat:** solid oak, natural or dark stain, clear protective lacquer finish.

**Base:** solid oak legs, natural or dark stain, clear protective lacquer finish. Footrest: chrome-plated tubular steel, anti-skid surface.

**Origin of wood:** oak (Quercus robur) from Western Europe and/or Poland.

## Tabouret Haut

	Article no.	without VAT in SEK*	with VAT in SEK*
	<b>212 016 00</b>		
natural oak, with protective varnish	1	8.080,00	<b>10.100,00</b>
dark oak, with protective varnish	2	8.080,00	<b>10.100,00</b>

# Tip Ton

Edward Barber & Jay Osgerby, 2011



All measurements are pursuant to EN 1335-1:2000  
More detailed information is found in the chapter 'Explanation of measurements'.

**Backrest, seat, base:** polypropylene.

**Glides:** polyethylene.

**Stacking:** Tip Ton can be stacked up to 4 chairs high on the floor, up to 11 on a stacking trolley. A stacking trolley is separately available.

**Outdoor use:** Tip Ton is suitable for outdoor use.

**Note:** special additives retard the fading of colours due to UV radiation. However, if the chair is exposed to sunlight for prolonged periods, the colour may change over time. We recommend limited exposure to sunlight.

## Tip Ton

	Article no.	without VAT in SEK*	with VAT in SEK*
<b>stackable</b>	<b>440 230 00</b>		
Shell in all colours		3.000,00	<b>3.750,00</b>

## Stacking trolley

	Article no.	without VAT in SEK*	with VAT in SEK*
<b>Suitable for up to 11 chairs</b>	<b>440 235 00</b>	14.720,00	<b>18.400,00</b>

### Plastic chair

- 01 basic dark
- 04 white
- 23 ice grey
- 35 basalt
- 37 glacier blue
- 74 olive
- 76 industrial green
- 78 mango

# Tip Ton RE

Edward Barber & Jay Osgerby, 2011/2020



All measurements are pursuant to EN 1335-1:2000  
More detailed information is found in the chapter 'Explanation of measurements'.

**Back, seat, base:** recycled polypropylene, 100% recyclable.

**Glides:** recycled polyethylene.

**Stacking:** Tip Ton RE can be stacked up to 4 chairs high on the floor, up to 11 on a stacking trolley. A stacking trolley is separately available.

**Outdoor use:** Tip Ton RE is suitable for outdoor use.

## Tip Ton RE

	Article no.	without VAT in SEK*	with VAT in SEK*
<b>stacking</b>	<b>440 231 00</b>		
recycled polypropylene		3.000,00	<b>3.750,00</b>

Recycled polypropylene

22 dark grey RE

# Unix Chair

Antonio Citterio, 2010

vitra.



Four-star base



Five-star base

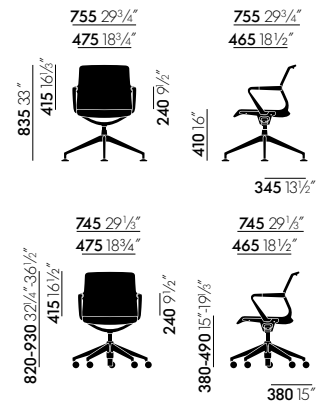

All measurements are pursuant to EN 1335-1:2000  
More detailed information is found in the chapter 'Explanation of measurements'.

**Seat frame and armrest sleeves:** monochrome polypropylene in basic dark or soft grey.

**Seat and back cover:** Plano fabric or one of the 3D spacer fabrics Diamond Mesh (mesh look) or Silk Mesh (solid look). For Silk Mesh in the colour soft grey, the reverse side is in soft grey. For Silk Mesh in the colours nero and asphalt, the reverse side is in nero. For Silk Mesh in the colours olive green, smoke blue and dim grey, the reverse side matches the frame colour (soft grey or nero).

**Five-star base:** polished die-cast aluminium with double castors (Ø 60 mm). Swivel mechanism, height adjustable.

**Four-star base:** polished die-cast aluminium on glides. Swivel mechanism with vertical spring suspension for added comfort.

## Unix Chair

	Article no.	without VAT in SEK*	with VAT in SEK*
<b>Four-star base</b>	<b>431 205 00</b>		
Silk Mesh		8.576,00	<b>10.720,00</b>
Diamond Mesh		8.576,00	<b>10.720,00</b>
Fabric F30		8.576,00	<b>10.720,00</b>

## Unix Chair

	Article no.	without VAT in SEK*	with VAT in SEK*
<b>Five-star base</b>	<b>431 206 00</b>		
Silk Mesh		9.408,00	<b>11.760,00</b>
Diamond Mesh		9.408,00	<b>11.760,00</b>
Fabric F30		9.408,00	<b>11.760,00</b>

### Fabric F30

### Frame

### Castors/Glides

Plano	30 basic dark 53 soft grey	02 castors hard, braked for carpet 03 castors soft, braked for hard floor 04 glides for carpet 05 felt glides for hard floor
-------	-------------------------------	---



# Unix Chair

Antonio Citterio, 2010

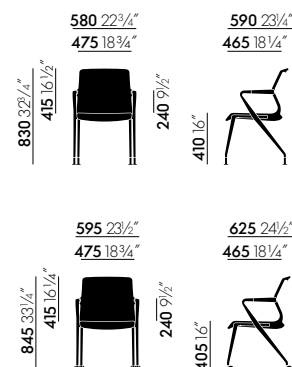

Unix Chair four-leg chair

Four-legged castor-based chair

All measurements are pursuant to EN 1335-1:2000  
More detailed information is found in the chapter 'Explanation of measurements'.

**Seat frame and armrest sleeves:** monochrome polypropylene in basic dark or soft grey.

**Seat and back cover:** Plano fabric or one of the 3D spacer fabrics Diamond Mesh (mesh look) or Silk Mesh (solid look). For Silk Mesh in the colour soft grey, the reverse side is in soft grey. For Silk Mesh in the colours nero and asphalt, the reverse side is in nero. For Silk Mesh in the colours olive green, smoke blue and dim grey, the reverse side matches the frame colour (soft grey or nero).

**Four-legged base:** polished, die-cast aluminium equipped with glides or castors (Ø 60 mm).

Unix Chair	Article no.	without VAT in SEK*	with VAT in SEK*
<b>Four-legged base</b>	<b>431 201 00</b>		
Silk Mesh		7.288,00	<b>9.110,00</b>
Diamond Mesh		7.288,00	<b>9.110,00</b>
Fabric F30		7.288,00	<b>9.110,00</b>
<b>Four-legged castor-based chair</b>	<b>431 202 00</b>		
Silk Mesh		7.288,00	<b>9.110,00</b>
Diamond Mesh		7.288,00	<b>9.110,00</b>
Fabric F30		7.288,00	<b>9.110,00</b>

Fabric F30	Frame	Castors/Glides
Plano	30 basic dark 53 soft grey	02 castors hard, braked for carpet 03 castors soft, braked for hard floor 04 glides for carpet 05 felt glides for hard floor

# Unix Chair

Antonio Citterio, 2010

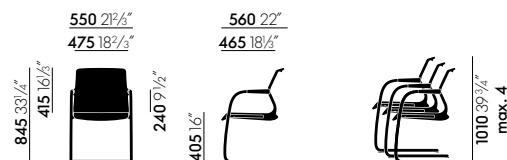

## Unix Chair Cantilever

All measurements are pursuant to EN 1335-1:2000  
More detailed information is found in the chapter 'Explanation of measurements'.

**Seat frame and armrest sleeves:** monochrome polypropylene in basic dark or soft grey.

**Seat and back cover:** Plano fabric or one of the 3D spacer fabrics Diamond Mesh (mesh look) or Silk Mesh (solid look). For Silk Mesh in the colour soft grey, the reverse side is in soft grey. For Silk Mesh in the colours nero and asphalt, the reverse side is in nero. For Silk Mesh in the colours olive green, smoke blue and dim grey, the reverse side matches the frame colour (soft grey or nero).

**Cantilever base:** chrome-plated tubular steel on glides. Non-stacking and stacking versions (max. 4 chairs).

Unix Chair	Article no.	without VAT in SEK*	with VAT in SEK*
<b>Cantilever tubular steel base</b>	<b>431 203 00</b>		
Silk Mesh		7.072,00	<b>8.840,00</b>
Diamond Mesh		7.072,00	<b>8.840,00</b>
Fabric F30		7.072,00	<b>8.840,00</b>
<b>Cantilever tubular steel base, stacking</b>	<b>431 204 00</b>		
Silk Mesh		7.792,00	<b>9.740,00</b>
Diamond Mesh		7.792,00	<b>9.740,00</b>
Fabric F30		7.792,00	<b>9.740,00</b>

Fabric F30	Frame	Castors/Glides
Plano	30 basic dark 53 soft grey	02 castors hard, braked for carpet 03 castors soft, braked for hard floor 04 glides for carpet 05 felt glides for hard floor

# Wiggle Side Chair & Wiggle Stool

Frank Gehry, 1972



Wiggle Side Chair

**Structure:** corrugated cardboard.

**Edges:** hardboard.

## Wiggle Side Chair

	Article no.	without VAT in SEK*	with VAT in SEK*
natural	210 186 01	9.440,00	11.800,00



Wiggle Stool

**Structure:** corrugated cardboard.

**Edges:** hardboard.

## Wiggle Stool

	Article no.	without VAT in SEK*	with VAT in SEK*
natural	210 226 01	5.032,00	6.290,00

# Wire Chair DKR

Charles & Ray Eames, 1951



DKR



DKR-2



DKR-5

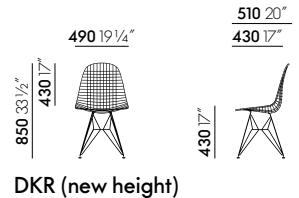

DKR (new height)

All measurements are pursuant to EN 1335-1:2000  
More detailed information is found in the chapter 'Explanation of measurements'.

**Upholstery:** unupholstered, with seat cushion or with seat and back pad. Seat and back pads can be removed and reattached; available in Hopsak fabric or leather. For the back pad in leather, the rear is always covered in Plano fabric, except for the version in leather snow, which is used on both the front and back.

**DKR:** Dining Height K-Wire Shell R-Wire Base

**Seat shell:** bent and welded steel wire, chrome-plated or powder-coated. The powder-coated version is suitable for outdoor use.

**Base:** four-legged base with cross struts, surface finish matched to seat shell. Fitted with plastic glides for carpet; felt glides for hard floors optionally available.

DKR (new height)	Article no.	without VAT in SEK*	with VAT in SEK*
<b>wire base with cross struts, non-stacking</b>	<b>412 150 00</b>		
without cover			
Frame chrome-plated or powder-coated	1	4.360,00	<b>5.450,00</b>

DKR-2 (new height)	Article no.	without VAT in SEK*	with VAT in SEK*
<b>wire base with cross struts, non-stacking</b>	<b>412 152 00</b>		
with seat and back pads			
Fabric F60		6.016,00	<b>7.520,00</b>
Fabric F200		7.976,00	<b>9.970,00</b>
Leather L20		6.696,00	<b>8.370,00</b>
Leather L50		7.376,00	<b>9.220,00</b>

DKR-5 (new height)	Article no.	without VAT in SEK*	with VAT in SEK*
<b>wire base with cross struts, non-stacking</b>	<b>412 151 00</b>		
with seat pad			
Fabric F60		5.360,00	<b>6.700,00</b>
Leather L20		5.800,00	<b>7.250,00</b>
Leather L50		6.472,00	<b>8.090,00</b>

Fabric F60	Fabric F200	Leather L20	Leather L50	Seat and base	Glides
. Hopsak	. Checker	. Leather	. Leather Premium F	01 chrome 04 white powder-coated (smooth) 30 basic dark powder-coated (smooth)	04 basic dark for carpet 05 felt basic dark for hard floor 14 white for carpet 15 felt white for hard floor

# Wire Chair DKR

Charles & Ray Eames, 1951

vitra.



## DKR Colours

Wire base with cross struts, powder-coated,  
non-stacking, glides in black

without cover

	Article no.	without VAT in SEK*	with VAT in SEK*
Eames Sea Foam Green 31	412 150 01	4.360,00	5.450,00
citron 92	412 150 02	4.360,00	5.450,00
sky blue 93	412 150 03	4.360,00	5.450,00
dark green 24	412 150 04	4.360,00	5.450,00

# Wire Chair DKW

Charles & Ray Eames, 1951



DKW



DKW-2



DKW-5



DKW (new height)

All measurements are pursuant to EN 1335-1:2000  
More detailed information is found in the chapter 'Explanation of measurements'.

**Upholstery:** unupholstered, with seat cushion or with seat and back pad. Seat and back pads can be removed and reattached; available in Hopsak fabric or leather. For the back pad in leather, the rear is always covered in Plano fabric, except for the version in leather snow, which is used on both the front and back.

**DKW:** Dining Height K-Wire Shell Wood-Base

**Seat shell:** bent and welded steel wire, powder-coated in basic dark.

**Base:** solid maple with stained finish, steel rod cross struts. Fitted with plastic glides for carpet; felt glides for hard floors optionally available.

**Origin of wood:** maple (*Acer platanoides*) from Western Europe and/or Poland.

## DKW (new height)

	Article no.	without VAT in SEK*	with VAT in SEK*
<b>wood base with cross struts, non-stacking</b>	<b>412 160 00</b>		
without cover			
Base maple		5.832,00	<b>7.290,00</b>

## DKW-2 (new height)

	Article no.	without VAT in SEK*	with VAT in SEK*
<b>wood base with cross struts, non-stacking</b>	<b>412 162 00</b>		
with seat and back pads			
Fabric F60		7.488,00	<b>9.360,00</b>
Fabric F200		9.448,00	<b>11.810,00</b>
Leather L20		8.168,00	<b>10.210,00</b>
Leather L50		8.848,00	<b>11.060,00</b>

## DKW-5 (new height)

	Article no.	without VAT in SEK*	with VAT in SEK*
<b>wood base with cross struts, non-stacking</b>	<b>412 161 00</b>		
with seat pad			
Fabric F60		6.832,00	<b>8.540,00</b>
Leather L20		7.272,00	<b>9.090,00</b>
Leather L50		7.944,00	<b>9.930,00</b>

Fabric F60	Fabric F200	Leather L20	Leather L50	Seat	Base	Glides
. Hopsak	. Checker	. Leather	. Leather Premium F	01 chrome 04 white powder-coated (smooth) 30 basic dark powder-coated (smooth)	02 golden maple 30 black maple 95 dark maple	04 basic dark for carpet 05 felt basic dark for hard floor 14 white for carpet 15 felt white for hard floor

# Wire Chair DKX

Charles & Ray Eames, 1951



DKX



DKX-2



DKX-5



DKX (new height)

All measurements are pursuant to EN 1335-1:2000  
More detailed information is found in the chapter 'Explanation of measurements'.

**Upholstery:** unupholstered, with seat cushion or with seat and back pad. Seat and back pads can be removed and reattached; available in Hopsak fabric or leather. For the back pad in leather, the rear is always covered in Plano fabric, except for the version in leather snow, which is used on both the front and back.

**DKX:** Dining Height K-Wire Shell X-Base

**Seat shell:** bent and welded steel wire, chrome-plated or powder-coated. The powder-coated version is suitable for outdoor use.

**Base:** four-legged tubular steel base, surface finish matched to seat shell. Fitted with plastic glides for carpet; felt glides for hard floors optionally available.

## DKX (new height)

	Article no.	without VAT in SEK*	with VAT in SEK*
<b>four-legged tubular steel base, non-stacking</b>	<b>412 155 00</b>		
without cover			
Frame chrome-plated or powder-coated		4.008,00	<b>5.010,00</b>

## DKX-2 (new height)

	Article no.	without VAT in SEK*	with VAT in SEK*
<b>four-legged tubular steel base, non-stacking</b>	<b>412 157 00</b>		
with seat and back pads			
Fabric F60		5.664,00	<b>7.080,00</b>
Fabric F200		7.624,00	<b>9.530,00</b>
Leather L20		6.344,00	<b>7.930,00</b>
Leather L50		7.024,00	<b>8.780,00</b>

## DKX-5 (new height)

	Article no.	without VAT in SEK*	with VAT in SEK*
<b>four-legged tubular steel base, non-stacking</b>	<b>412 156 00</b>		
with seat pad			
Fabric F60		5.008,00	<b>6.260,00</b>
Leather L20		5.448,00	<b>6.810,00</b>
Leather L50		6.120,00	<b>7.650,00</b>

Fabric F60	Fabric F200	Leather L20	Leather L50	Seat and base	Glides
. Hopsak	. Checker	. Leather	. Leather Premium F	01 chrome 04 white powder-coated (smooth) 30 basic dark powder-coated (smooth)	04 basic dark for carpet 05 felt basic dark for hard floor 14 white for carpet 15 felt white for hard floor

# Wire Chair LKR

Charles & Ray Eames, 1951



LKR



LKR-2



LKR-5

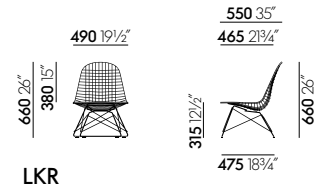

LKR

All measurements are pursuant to EN 1335-1:2000  
More detailed information is found in the chapter 'Explanation of measurements'.

**Upholstery:** unupholstered, with seat cushion or with seat and back pad. Seat and back pads can be removed and reattached; available in Hopsak fabric or leather. For the back pad in leather, the rear is always covered in Plano fabric, except for the version in leather snow, which is used on both the front and back.

**LKR:** Lounge Height K-Wire Shell, Rod base.

**Seat shell:** bent and welded steel wire, chrome-plated or powder-coated. The powder-coated version is suitable for outdoor use.

**Base:** wire base with cross struts, chrome-plated or powder-coated finish. Surface finish matched to seat shell. The powder-coated version is suitable for outdoor use. Seat height 260 mm.

LKR	Article no.	without VAT in SEK*	with VAT in SEK*
<b>wire base with cross struts, non-stacking</b>		<b>412 254 00</b>	
without cover			
Base chrome		5.336,00	<b>6.670,00</b>

LKR-2	Article no.	without VAT in SEK*	with VAT in SEK*
<b>wire base with cross struts, non-stacking</b>		<b>412 256 00</b>	
with seat and back cushions			
Fabric F60		6.992,00	<b>8.740,00</b>
Fabric F200		8.952,00	<b>11.190,00</b>
Leather L20		7.672,00	<b>9.590,00</b>
Leather L50		8.352,00	<b>10.440,00</b>

LKR-5	Article no.	without VAT in SEK*	with VAT in SEK*
<b>wire base with cross struts, non-stacking</b>		<b>412 255 00</b>	
with seat cushion			
Fabric F60		6.336,00	<b>7.920,00</b>
Leather L20		6.776,00	<b>8.470,00</b>
Leather L50		7.448,00	<b>9.310,00</b>

Fabric F60	Leather L20	Leather L50	Seat and base	Glides
. Hopsak	. Leather	. Leather Premium F	01 chrome 04 white powder-coated (smooth) 30 basic dark powder-coated (smooth)	04 basic dark for carpet 05 felt basic dark for hard floor 14 white for carpet 15 felt white for hard floor



# Wire Chair LKR

Charles & Ray Eames, 1951

**vitra.**



## LKR Colours

Wire base with cross struts, powder-coated,  
non-stacking, glides in black

without cover

	Article no.	without VAT in SEK*	with VAT in SEK*
<b>Eames Sea Foam Green 31</b>	<b>412 254 01</b>	5.336,00	<b>6.670,00</b>
<b>citron 92</b>	<b>412 254 02</b>	5.336,00	<b>6.670,00</b>
<b>sky blue 93</b>	<b>412 254 03</b>	5.336,00	<b>6.670,00</b>
<b>dark green 24</b>	<b>412 254 04</b>	5.336,00	<b>6.670,00</b>

## Tables



Belleville Table  
R & E Bouroullec  
162



Bistro Table  
R & E Bouroullec  
164



Eames Contract Tables  
Charles & Ray Eames  
168



Eames Segmented Tables Dining  
Charles & Ray Eames  
170



EM Table  
Jean Prouvé  
172



Dining Table  
Isamu Noguchi  
176



Guéridon  
Jean Prouvé  
177



Plate Dining Table  
Jasper Morrison  
178



Super Fold Table  
Jasper Morrison  
180



Super Fold Table  
Jasper Morrison  
182



Table S.A.M. Bois  
Jean Prouvé  
184



Trapèze  
Jean Prouvé  
185

Office and conference chairs (swivel)

Chairs

Tables

Desks

Public waiting areas

Lounge chairs and armchairs

Sofas

Coffee and side tables

Stools and benches

Storage and partition elements

Accessories

Living, dining, decorative objects, home office,  
clocks, lighting, publications

Quick Ship programme

General terms, conditions  
and information

# Belleville Table

Ronan & Erwan Bouroullec, 2015



Ø 796 31¼"



Ø 796 31¼"

Round table, Ø 796 mm

1060 41¾"

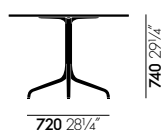

Square table, 750 x 750 mm

1600 63"



Rectangular table, 1600 x 750 mm

**Table top:** oak veneer in natural or dark oak (20 mm); melamine faced in white with smooth straight plastic edge (19 mm); or solid core material with black edge (12 mm) in the colours white or black. Solid core table top in black with anti-fingerprint coating.

**Base:** powder-coated with finely textured finish in deep black (RAL 9005). The height of the base including screw-in glides is 720 mm; the glides can be adjusted (max. extension 10 mm) for levelling on uneven floors.

**Applications:** table with top in solid core material and powder-coated base is suited for outdoor use. We recommend limited exposure to sunlight. The powder-coated bases are pre-galvanised.

# Belleville Table

Ronan & Erwan Bouroullec, 2015

**vitra.**

## Round table, indoor, Ø 796 mm

	Article no.	without VAT in SEK*	with VAT in SEK*
	<b>443 024 01</b>		
Base deep black, melamine white	1203	6.552,00	<b>8.190,00</b>
Base deep black, veneer dark oak	1204	11.200,00	<b>14.000,00</b>
Base deep black, veneer light oak	1217	11.200,00	<b>14.000,00</b>

## Round table, outdoor, Ø 796 mm

	Article no.	without VAT in SEK*	with VAT in SEK*
	<b>443 025 01</b>		
Base deep black, solid core material white	1201	8.160,00	<b>10.200,00</b>
Base deep black, solid core material black	1230	8.160,00	<b>10.200,00</b>

## Square table, indoor, 750 x 750 mm

	Article no.	without VAT in SEK*	with VAT in SEK*
	<b>443 026 01</b>		
Base deep black, melamine white	1203	6.552,00	<b>8.190,00</b>
Base deep black, veneer dark oak	1204	11.200,00	<b>14.000,00</b>
Base deep black, veneer light oak	1217	11.200,00	<b>14.000,00</b>

## Square table, outdoor, 750 x 750 mm

	Article no.	without VAT in SEK*	with VAT in SEK*
	<b>443 027 01</b>		
Base deep black, solid core material white	1201	8.160,00	<b>10.200,00</b>
Base deep black, solid core material black	1230	8.160,00	<b>10.200,00</b>

## Rectangular table, indoor, 1600 x 750 mm

	Article no.	without VAT in SEK*	with VAT in SEK*
	<b>443 028 01</b>		
Base deep black, melamine white	1203	15.360,00	<b>19.200,00</b>
Base deep black, veneer dark oak	1204	20.960,00	<b>26.200,00</b>
Base deep black, veneer light oak	1217	20.960,00	<b>26.200,00</b>

## Rectangular table, outdoor, 1600 x 750 mm

	Article no.	without VAT in SEK*	with VAT in SEK*
	<b>443 029 01</b>		
Base deep black, solid core material white	1201	16.640,00	<b>20.800,00</b>
Base deep black, solid core material black	1230	16.640,00	<b>20.800,00</b>

# Bistro Stand-up Table

Ronan & Erwan Bouroullec, 2010



Ø 796 Ø 31¼"



Ø 796 Ø 31¼"



1100 43¼"

Ø 642 Ø 25¼"



Ø 642 Ø 25¼"



1100 43¼"

**Table tops available in three materials:** melamine faced, white surface, smooth straight plastic edge (19 mm); light or dark oak veneer (Europe) (19 mm); solid core laminate in the colours white or black with black edge (12 mm). The solid core table top in black has an additional anti-fingerprint coating.

**Base:** powder-coated in basic dark (RAL 9004). The height of the base including screw-in glides is 1080 mm; the glides can be adjusted (max. extension 10 mm) for levelling on uneven floors.

**Applications:** table with top in solid core laminate is also suited for outdoor use. We recommend limiting the table's exposure to sunlight. Pre-galvanised base.

## Round table, indoor, Ø 796 mm

	Article no.	without VAT in SEK*	with VAT in SEK*
<b>443 010 00</b>			
basic dark, melamine white	3001	6.792,00	<b>8.490,00</b>
basic dark, compact laminate white	3004	8.400,00	<b>10.500,00</b>
basic dark, compact laminate black	3005	9.360,00	<b>11.700,00</b>
basic dark, light oak veneer	3002	12.240,00	<b>15.300,00</b>
basic dark, dark oak veneer	3003	12.240,00	<b>15.300,00</b>
<b>package of 10</b>			
<b>443 010 01</b>			
basic dark, melamine white	3001	67.920,00	<b>84.900,00</b>
basic dark, compact laminate white	3004	84.000,00	<b>105.000,00</b>
basic dark, compact laminate black	3005	93.600,00	<b>117.000,00</b>
basic dark, light oak veneer	3002	122.400,00	<b>153.000,00</b>
basic dark, dark oak veneer	3003	122.400,00	<b>153.000,00</b>

# Bistro Stand-up Table

Ronan & Erwan Bouroullec, 2010

<b>Round table, outdoor, Ø 796 mm</b>	Article no.	without VAT in SEK*	with VAT in SEK*
	<b>443 011 00</b>		
basic dark, compact laminate white	3004	10.080,00	<b>12.600,00</b>
basic dark, compact laminate black	3005	10.960,00	<b>13.700,00</b>
<b>package of 10</b>	<b>443 011 01</b>		
basic dark, compact laminate white	3004	100.800,00	<b>126.000,00</b>
basic dark, compact laminate black	3005	109.600,00	<b>137.000,00</b>

<b>Round table, indoor, Ø 642 mm</b>	Article no.	without VAT in SEK*	with VAT in SEK*
	<b>443 012 00</b>		
basic dark, melamine white	3001	6.680,00	<b>8.350,00</b>
basic dark, compact laminate white	3004	8.320,00	<b>10.400,00</b>
basic dark, compact laminate black	3005	9.120,00	<b>11.400,00</b>
basic dark, light oak veneer	3002	12.160,00	<b>15.200,00</b>
basic dark, dark oak veneer	3003	12.160,00	<b>15.200,00</b>
<b>package of 10</b>	<b>443 012 01</b>		
basic dark, melamine white	3001	66.800,00	<b>83.500,00</b>
basic dark, compact laminate white	3004	83.200,00	<b>104.000,00</b>
basic dark, compact laminate black	3005	91.200,00	<b>114.000,00</b>
basic dark, light oak veneer	3002	121.600,00	<b>152.000,00</b>
basic dark, dark oak veneer	3003	121.600,00	<b>152.000,00</b>

<b>Round table, outdoor, Ø 642 mm</b>	Article no.	without VAT in SEK*	with VAT in SEK*
	<b>443 013 00</b>		
basic dark, compact laminate white	3004	9.840,00	<b>12.300,00</b>
basic dark, compact laminate black	3005	10.640,00	<b>13.300,00</b>
<b>package of 10</b>	<b>443 013 01</b>		
basic dark, compact laminate white	3004	98.400,00	<b>123.000,00</b>
basic dark, compact laminate black	3005	106.400,00	<b>133.000,00</b>

# Bistro Table

Ronan & Erwan Bouroullec, 2009/2010



Ø796 Ø31¼"



Ø796 Ø31¼"



740 29¼"

640 25¼"



640 25¼"



796 31¼"

740 31¼"

**Table tops available in three materials:** melamine faced, white surface, smooth straight plastic edge (19 mm); light or dark oak veneer (Europe) (19 mm); solid core laminate in the colours white or black with black edge (12 mm). The solid core table top in black has an additional anti-fingerprint coating.

**Base:** powder-coated in basic dark (RAL 9004). The height of the base including screw-in glides is 715 mm; the glides can be adjusted (max. extension 10 mm) for levelling on uneven floors.

**Applications:** table with top in solid core laminate is also suited for outdoor use. We recommend limiting the table's exposure to sunlight. Pre-galvanised base.

## Round table, indoor, Ø 796 mm

	Article no.	without VAT in SEK*	with VAT in SEK*
<b>443 008 00</b>			
basic dark, melamine white	3001	6.600,00	<b>8.250,00</b>
basic dark, compact laminate white	3004	8.320,00	<b>10.400,00</b>
basic dark, compact laminate black	3005	9.200,00	<b>11.500,00</b>
basic dark, light oak veneer	3002	12.160,00	<b>15.200,00</b>
basic dark, dark oak veneer	3003	12.160,00	<b>15.200,00</b>
<b>package of 10</b>			
<b>443 008 01</b>			
basic dark, melamine white	3001	66.000,00	<b>82.500,00</b>
basic dark, compact laminate white	3004	83.200,00	<b>104.000,00</b>
basic dark, compact laminate black	3005	92.000,00	<b>115.000,00</b>
basic dark, light oak veneer	3002	121.600,00	<b>152.000,00</b>
basic dark, dark oak veneer	3003	121.600,00	<b>152.000,00</b>



# Bistro Table

Ronan & Erwan Bouroullec, 2009/2010

**vitra.**

## Round table, outdoor, Ø 796 mm

	Article no.	without VAT in SEK*	with VAT in SEK*
	<b>443 009 00</b>		
basic dark, compact laminate white	3004	9.840,00	<b>12.300,00</b>
basic dark, compact laminate black	3005	10.800,00	<b>13.500,00</b>
<b>package of 10</b>	<b>443 009 01</b>		
basic dark, compact laminate white	3004	98.400,00	<b>123.000,00</b>
basic dark, compact laminate black	3005	108.000,00	<b>135.000,00</b>

## Rectangular table, indoor, 640 x 796 mm

	Article no.	without VAT in SEK*	with VAT in SEK*
	<b>443 006 00</b>		
basic dark, melamine white	3001	6.680,00	<b>8.350,00</b>
basic dark, compact laminate white	3004	7.832,00	<b>9.790,00</b>
basic dark, compact laminate black	3005	8.240,00	<b>10.300,00</b>
basic dark, light oak veneer	3002	11.760,00	<b>14.700,00</b>
basic dark, dark oak veneer	3003	11.760,00	<b>14.700,00</b>
<b>package of 10</b>	<b>443 006 01</b>		
basic dark, melamine white	3001	66.800,00	<b>83.500,00</b>
basic dark, compact laminate white	3004	78.320,00	<b>97.900,00</b>
basic dark, compact laminate black	3005	82.400,00	<b>103.000,00</b>
basic dark, light oak veneer	3002	117.600,00	<b>147.000,00</b>
basic dark, dark oak veneer	3003	117.600,00	<b>147.000,00</b>

## Rectangular table, outdoor, 640 x 796 mm

	Article no.	without VAT in SEK*	with VAT in SEK*
	<b>443 007 00</b>		
basic dark, compact laminate white	3004	9.360,00	<b>11.700,00</b>
basic dark, compact laminate black	3005	9.760,00	<b>12.200,00</b>
<b>package of 10</b>	<b>443 007 01</b>		
basic dark, compact laminate white	3004	93.600,00	<b>117.000,00</b>
basic dark, compact laminate black	3005	97.600,00	<b>122.000,00</b>

# Eames Contract Tables

Charles & Ray Eames, 1968

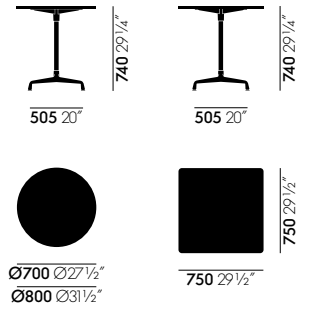

**Table tops:** available in four materials: melamine faced white surface (25 mm) with smooth straight plastic edge in white; light or dark oak veneer (Europe) (25 mm) with straight veneer edge; solid core laminate in white (12 mm) with black edge; HPL (25 mm) with black edge.

**Base:** stable pedestal base, four-star legs in die-cast aluminium. Available in four versions: base polished or chrome-plated with column in basic dark (RAL 9004), all chrome or all powder-coated (textured finish) in deep black (RAL 9005) or white (RAL 9010). The height of the base including screw-in glides is 71 cm; the glides can be adjusted (max. extension 10 mm) for levelling on uneven floors.

**Applications:** the powder-coated base can be paired with a solid core table top for outdoor use.

# Eames Contract Tables

## Charles & Ray Eames, 1968

### Round table, Ø 70

	Article no.	without VAT in SEK*	with VAT in SEK*
<b>443 039 01</b>			
<b>Table top</b>			
melamine white	03	6.672,00	<b>8.340,00</b>
compact laminate white, suitable for outdoor use	01	7.744,00	<b>9.680,00</b>
HPL white, plastic edge black	12	8.592,00	<b>10.740,00</b>
light oak veneer	17	10.160,00	<b>12.700,00</b>
dark oak veneer	04	10.160,00	<b>12.700,00</b>
<b>Universal base</b>			
base polished, column powder-coated in basic dark	40	0,00	<b>0,00</b>
base chrome, column powder-coated in basic dark	10	472,00	<b>590,00</b>
base and column powder-coated in deep black, suitable for outdoor use	51	472,00	<b>590,00</b>
base and column powder-coated in white, suitable for outdoor use	61	472,00	<b>590,00</b>
base and column chrome	20	832,00	<b>1.040,00</b>

### Round table, Ø 80

	Article no.	without VAT in SEK*	with VAT in SEK*
<b>443 040 01</b>			
<b>Table top</b>			
melamine white	03	6.904,00	<b>8.630,00</b>
compact laminate white, suitable for outdoor use	01	8.200,00	<b>10.250,00</b>
HPL white, plastic edge black	12	9.176,00	<b>11.470,00</b>
light oak veneer	17	11.344,00	<b>14.180,00</b>
dark oak veneer	04	11.344,00	<b>14.180,00</b>
<b>Universal base</b>			
base polished, column powder-coated in basic dark	40	0,00	<b>0,00</b>
base chrome, column powder-coated in basic dark	10	472,00	<b>590,00</b>
base and column powder-coated in deep black, suitable for outdoor use	51	472,00	<b>590,00</b>
base and column powder-coated in white, suitable for outdoor use	61	472,00	<b>590,00</b>
base and column chrome	20	832,00	<b>1.040,00</b>

### Square table, 75 x 75

	Article no.	without VAT in SEK*	with VAT in SEK*
<b>443 042 01</b>			
<b>Table top</b>			
melamine white	03	6.904,00	<b>8.630,00</b>
compact laminate white, suitable for outdoor use	01	8.200,00	<b>10.250,00</b>
HPL white, plastic edge black	12	9.176,00	<b>11.470,00</b>
light oak veneer	17	11.344,00	<b>14.180,00</b>
dark oak veneer	04	11.344,00	<b>14.180,00</b>
<b>Universal base</b>			
base polished, column powder-coated in basic dark	40	0,00	<b>0,00</b>
base chrome, column powder-coated in basic dark	10	472,00	<b>590,00</b>
base and column powder-coated in deep black, suitable for outdoor use	51	472,00	<b>590,00</b>
base and column powder-coated in white, suitable for outdoor use	61	472,00	<b>590,00</b>
base and column chrome	20	832,00	<b>1.040,00</b>

# Eames Segmented Tables Dining

## Charles & Ray Eames, 1964

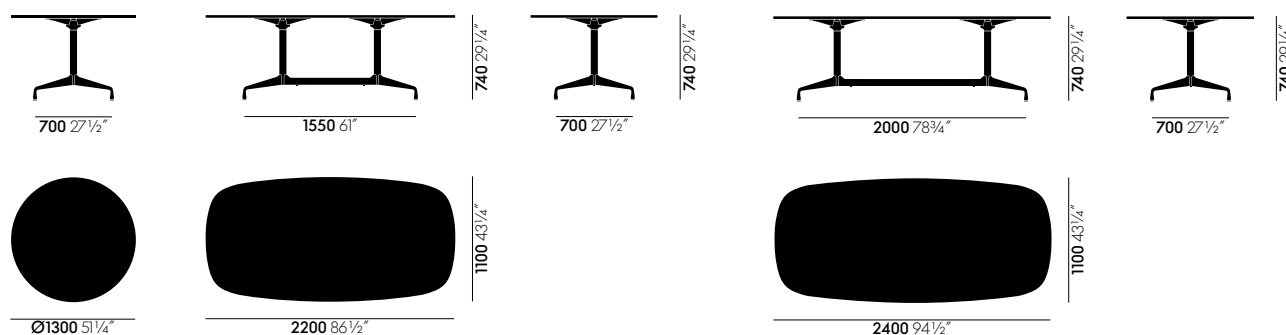

**Table top:** 25 mm thick, solid wood in natural oak with oiled finish, dark stained oak with protective natural lacquer finish, or American walnut with oiled finish; or HPL (high-pressure laminate) surface with black edges.

**Base:** components for segmented base include legs, spreader connectors, spreaders, columns and spiders. Legs polished or chrome-plated with column in basic dark (RAL 9004), all chrome or all powder-coated (textured finish) in deep black (RAL 9005).

**Origin of wood:** oak (*Quercus robur*) from Western Europe and/or Poland; American walnut (*Juglans nigra*) from the USA.

# Eames Segmented Tables Dining

## Charles & Ray Eames, 1964

**vitra.**

### Round table Ø 130

	Article no.	without VAT in SEK*	with VAT in SEK*
<b>H 740 x Ø 1300 mm</b>	<b>403 115 01</b>		
<b>Table top</b>			
HPL white, plastic edge black	M1S12	16.880,00	21.100,00
solid natural oak, oiled finish	G1S70	36.320,00	45.400,00
dark solid oak, with protective varnish	G1S04	44.080,00	55.100,00
solid American walnut, oiled finish	G1S75	50.640,00	63.300,00
<b>Base</b>			
legs polished, column basic dark	OF40	0,00	0,00
legs and column deep black	OF51	0,00	0,00
legs chrome, column basic dark	OF10	1.184,00	1.480,00
legs and column chrome	OF20	2.232,00	2.790,00
	<b>Basic price:</b>	<b>16.880,00</b>	<b>21.100,00</b>

### Boat-shaped table 220 x 110

	Article no.	without VAT in SEK*	with VAT in SEK*
<b>H 740 x W 2200 x D 1100 mm</b>	<b>403 116 01</b>		
<b>Table top</b>			
HPL white, plastic edge black	M1S12	28.640,00	35.800,00
solid natural oak, oiled finish	G1S70	53.600,00	67.000,00
dark solid oak, with protective varnish	G1S04	64.720,00	80.900,00
solid American walnut, oiled finish	G1S75	74.560,00	93.200,00
<b>Base</b>			
legs polished, column basic dark	OF40	0,00	0,00
legs and column deep black	OF51	0,00	0,00
legs chrome, column basic dark	OF10	1.640,00	2.050,00
base and column chrome	OF20	4.392,00	5.490,00
	<b>Basic price:</b>	<b>28.640,00</b>	<b>35.800,00</b>

### Boat-shaped table 240 x 110

	Article no.	without VAT in SEK*	with VAT in SEK*
<b>H 740 x W 2400 x D 1100 mm</b>	<b>403 117 01</b>		
<b>Table top</b>			
HPL white, plastic edge black	M1S12	36.880,00	46.100,00
solid natural oak, oiled finish	G1S70	68.720,00	85.900,00
dark solid oak, with protective varnish	G1S04	83.120,00	103.900,00
solid American walnut, oiled finish	G1S75	95.520,00	119.400,00
<b>Base</b>			
legs polished, column basic dark	OF40	0,00	0,00
legs and column deep black	OF51	0,00	0,00
legs chrome, column basic dark	OF10	1.640,00	2.050,00
base and column chrome	OF20	4.720,00	5.900,00
	<b>Basic price:</b>	<b>36.880,00</b>	<b>46.100,00</b>

## EM Table

Jean Prouvé, 1950



EM Table



EM Table (HPL)

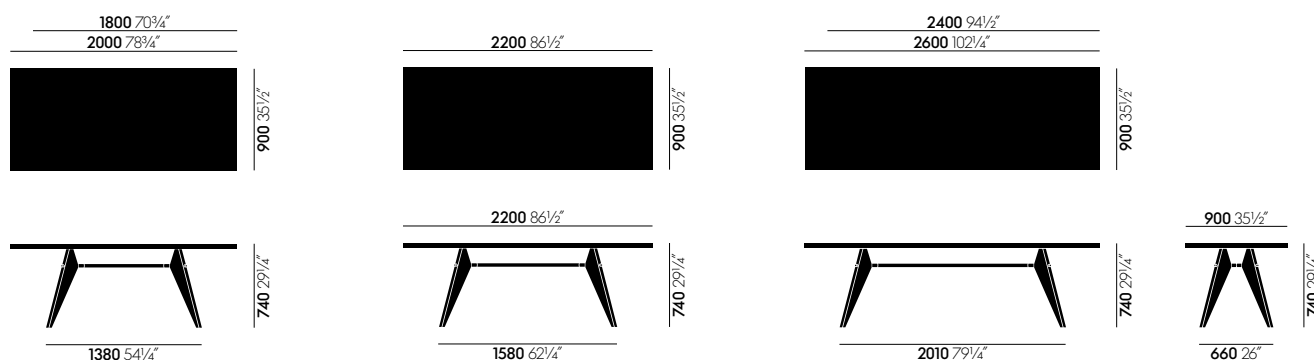

**Solid wood table top:** 34 mm thick; natural oak with oiled finish, dark stained oak with protective natural lacquer finish, or American walnut with oiled finish.

**Base:** bent sheet steel and tubular steel, powder-coated.

**Note:** the steel frame in Métal Brut has a raw irregular surface protected by a transparent powder coating.

**Origin of wood:** oak (*Quercus robur*) from Western Europe and/or Poland; American walnut (*Juglans nigra*) from the USA.

**Veneer table top:** 39 mm thick; natural or dark stained oak (Europe), protective natural lacquer finish.

**Base:** bent sheet steel and tubular steel, powder-coated.

**HPL table top:** 40 mm thick, high pressure laminate surface and edges.

**Base:** bent sheet steel and tubular steel, powder-coated.

# EM Table

Jean Prouvé, 1950

EM Table (wood)	Article no.	without VAT in SEK*	with VAT in SEK*
<b>H 740 x W 900 x L 1800 mm</b>	<b>212 033 00</b>		
natural oak veneer with protective varnish	03	34.160,00	<b>42.700,00</b>
dark oak veneer with protective varnish	04	34.160,00	<b>42.700,00</b>
natural solid oak, oiled	70	40.080,00	<b>50.100,00</b>
dark solid oak, with protective varnish	44	48.640,00	<b>60.800,00</b>
solid American walnut, oiled	75	55.520,00	<b>69.400,00</b>
<b>H 740 x W 900 x L 2000 mm</b>	<b>212 034 00</b>		
natural oak, veneer with protective varnish	03	37.200,00	<b>46.500,00</b>
dark oak, veneer with protective varnish	04	37.200,00	<b>46.500,00</b>
solid oak, natural, oiled	70	43.600,00	<b>54.500,00</b>
dark solid oak, with protective varnish	44	53.120,00	<b>66.400,00</b>
solid American walnut, oiled	75	60.160,00	<b>75.200,00</b>
<b>H 740 x W 900 x L 2200 mm</b>	<b>212 035 00</b>		
natural oak veneer with protective varnish	03	38.960,00	<b>48.700,00</b>
dark oak veneer with protective varnish	04	38.960,00	<b>48.700,00</b>
natural solid oak, oiled	70	45.760,00	<b>57.200,00</b>
dark solid oak, with protective varnish	44	55.600,00	<b>69.500,00</b>
solid American walnut, oiled	75	63.360,00	<b>79.200,00</b>
<b>H 740 x W 900 x L 2400 mm</b>	<b>212 036 00</b>		
natural oak, veneer with protective varnish	03	42.640,00	<b>53.300,00</b>
dark oak, veneer with protective varnish	04	42.640,00	<b>53.300,00</b>
solid oak, natural, oiled	70	50.160,00	<b>62.700,00</b>
dark solid oak, with protective varnish	44	60.800,00	<b>76.000,00</b>
solid American walnut, oiled	75	69.680,00	<b>87.100,00</b>
<b>H 740 x W 900 x L 2600 mm</b>	<b>212 037 00</b>		
natural oak veneer with protective varnish	03	46.400,00	<b>58.000,00</b>
dark oak veneer with protective varnish	04	46.400,00	<b>58.000,00</b>
natural solid oak, oiled	70	54.640,00	<b>68.300,00</b>
dark solid oak, with protective varnish	44	66.160,00	<b>82.700,00</b>
solid American walnut, oiled	75	76.000,00	<b>95.000,00</b>
<b>Surcharges base</b>			
Colour group 1		0,00	<b>0,00</b>
Colour group 2		1.352,00	<b>1.690,00</b>

#### Base frame Colour group 1

06 Japanese red powder-coated (smooth)  
12 deep black powder-coated (smooth)  
88 Prouvé Blanc Colombe (Ecrû) powder-coated (smooth)

#### Base frame Colour group 2

13 Prouvé Gris Vermeer powder-coated (smooth)  
14 Prouvé Bleu Dynastie powder-coated (smooth)  
18 Prouvé Blé Vert powder-coated (smooth)  
41 Prouvé Bleu Marcoule powder-coated (smooth)  
94 Prouvé Métal Brut powder-coated (transparent, smooth)

# EM Table

Jean Prouvé, 1950

**vitra.**

<b>EM Table (HPL)</b>	Article no.	without VAT in SEK*	with VAT in SEK*
<b>H 740 x W 900 x L 1800 mm</b>	<b>212 038 00</b>		
HPL ivory	49	26.800,00	<b>33.500,00</b>
HPL asphalt	67	26.800,00	<b>33.500,00</b>
<b>H 740 x W 900 x L 2000 mm</b>	<b>212 039 00</b>		
HPL ivory	49	27.920,00	<b>34.900,00</b>
HPL asphalt	67	27.920,00	<b>34.900,00</b>
<b>H 740 x W 900 x L 2200 mm</b>	<b>212 040 00</b>		
HPL ivory	49	30.720,00	<b>38.400,00</b>
HPL asphalt	67	30.720,00	<b>38.400,00</b>
<b>H 740 x W 900 x L 2400 mm</b>	<b>212 041 00</b>		
HPL ivory	49	33.440,00	<b>41.800,00</b>
HPL asphalt	67	33.440,00	<b>41.800,00</b>
<b>H 740 x W 900 x L 2600 mm</b>	<b>212 042 00</b>		
HPL ivory	49	36.640,00	<b>45.800,00</b>
HPL asphalt	67	36.640,00	<b>45.800,00</b>
<b>Surcharges base</b>			
Colour group 1		0,00	<b>0,00</b>
Colour group 2		1.352,00	<b>1.690,00</b>

#### Base frame Colour group 1

06 Japanese red powder-coated (smooth)  
12 deep black powder-coated (smooth)  
88 Prouvé Blanc Colombe (Ecrû) powder-coated (smooth)

#### Base frame Colour group 2

13 Prouvé Gris Vermeer powder-coated (smooth)  
14 Prouvé Bleu Dynastie powder-coated (smooth)  
18 Prouvé Blé Vert powder-coated (smooth)  
41 Prouvé Bleu Marcoule powder-coated (smooth)  
94 Prouvé Métal Brut powder-coated (transparent, smooth)





# Dining Table

Isamu Noguchi, 1957

vitra.

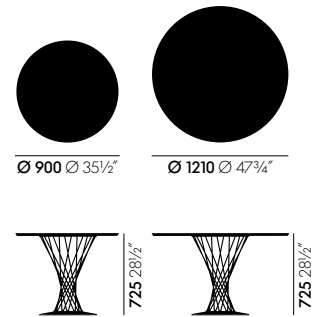

**Table top:** plywood with hard laminate surface, black-stained edge.

**Base:** cast iron with black lacquer finish, chrome-plated steel wire.

**Range of use:** recommended for residential use only.

## Dining Table

		Article no.	without VAT in SEK*	with VAT in SEK*
Ø 900 mm	white table top	201 328 02	39.600,00	49.500,00
Ø 1210 mm	white table top	201 328 01	41.600,00	52.000,00

# Guéridon

Jean Prouvé, 1949

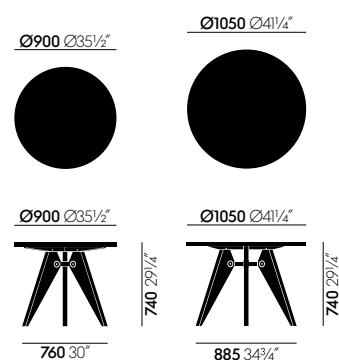

**Table top:** solid wood in natural oak with oiled finish, dark stained oak with protective natural lacquer finish, or American walnut with oiled finish.

**Base:** legs matched to table top, solid wood in natural oak with oiled finish, dark stained oak with protective natural lacquer finish, or American walnut with oiled finish; tubular steel crossbar with powder-coated finish (smooth)

**Origin of wood:** oak (*Quercus robur*) from Western Europe and/or Poland; American walnut (*Juglans nigra*) from the USA.

Guéridon	Article no.	without VAT in SEK*	with VAT in SEK*
<b>Ø 900 x H 740 mm</b>	<b>212 024 00</b>		
solid natural oak, oiled	70	21.040,00	<b>26.300,00</b>
solid dark oak, with protective varnish	04	24.640,00	<b>30.800,00</b>
solid American walnut, oiled	75	29.520,00	<b>36.900,00</b>
<b>Ø 1050 x H 740 mm</b>	<b>212 025 00</b>		
solid natural oak, oiled	70	22.560,00	<b>28.200,00</b>
solid dark oak, with protective varnish	04	26.560,00	<b>33.200,00</b>
solid American walnut, oiled	75	31.760,00	<b>39.700,00</b>

# Plate Dining Table

Jasper Morrison, 2018

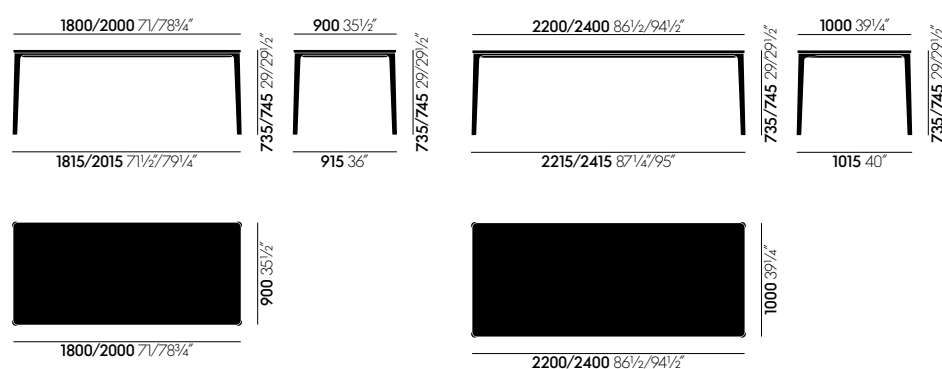

**MDF table tops:** 25 mm thick, powder-coated finish.

**Solid wood table tops:** 22 mm thick, oiled; natural oak or dark oak with protective natural lacquer finish.

**Glass table top:** 12 mm thick, float glass with satin finish, lacquered underside, ground edge.

**Marble table top:** 15 mm thick, Carrara marble, brushed and waxed.

**Base:** legs in die-cast aluminium, extruded crossbars, powder-coated.

**Origin of wood:** oak (*Quercus robur*) from Germany and France.

# Plate Dining Table

Jasper Morrison, 2018

Plate Dining Table	Article no.	without VAT in SEK*	with VAT in SEK*
<b>H 735/745 x W 900 x L 1800 mm</b>	<b>212 053 00</b>		
MDF, powder-coated in white	04	25.360,00	<b>31.700,00</b>
MDF, powder-coated in basic dark	30	25.360,00	<b>31.700,00</b>
satin-finished glass, underside lacquered in light grey	83	31.440,00	<b>39.300,00</b>
satin-finished glass, underside lacquered in white	82	31.440,00	<b>39.300,00</b>
solid natural oak, oiled finish	70	36.560,00	<b>45.700,00</b>
solid dark oak, with protective varnish	44	44.320,00	<b>55.400,00</b>
Carrara marble	50	72.800,00	<b>91.000,00</b>
<b>H 735/745 x W 900 x L 2000 mm</b>	<b>212 054 00</b>		
MDF, powder-coated in white	04	27.520,00	<b>34.400,00</b>
MDF, powder-coated in basic dark	30	27.520,00	<b>34.400,00</b>
satin-finished glass, underside lacquered in light grey	83	34.400,00	<b>43.000,00</b>
satin-finished glass, underside lacquered in white	82	34.400,00	<b>43.000,00</b>
solid natural oak, oiled finish	70	39.680,00	<b>49.600,00</b>
solid dark oak, with protective varnish	44	48.000,00	<b>60.000,00</b>
Carrara marble	50	78.880,00	<b>98.600,00</b>
<b>H 735/745 x W 1000 x L 2200 mm</b>	<b>212 055 00</b>		
MDF, powder-coated in white	04	29.120,00	<b>36.400,00</b>
MDF, powder-coated in basic dark	30	29.120,00	<b>36.400,00</b>
satin-finished glass, underside lacquered in light grey	83	36.160,00	<b>45.200,00</b>
satin-finished glass, underside lacquered in white	82	36.160,00	<b>45.200,00</b>
solid natural oak, oiled finish	70	41.680,00	<b>52.100,00</b>
solid dark oak, with protective varnish	44	50.560,00	<b>63.200,00</b>
Carrara marble	50	83.120,00	<b>103.900,00</b>
<b>H 735/745 x W 1000 x L 2400 mm</b>	<b>212 056 00</b>		
MDF, powder-coated in white	04	31.440,00	<b>39.300,00</b>
MDF, powder-coated in basic dark	30	31.440,00	<b>39.300,00</b>
satin-finished glass, underside lacquered in light grey	83	39.600,00	<b>49.500,00</b>
satin-finished glass, underside lacquered in white	82	39.600,00	<b>49.500,00</b>
solid natural oak, oiled finish	70	45.680,00	<b>57.100,00</b>
solid dark oak, with protective varnish	44	55.200,00	<b>69.000,00</b>
Carrara marble	50	90.480,00	<b>113.100,00</b>

Table top glass	Table top marble	Table top MDF	Table top solid wood	Base
82 white satin finish 83 light grey satin finish	50 marble Carrara	04 white powder-coated 30 basic dark powder-coated (textured)	04 dark stained solid oak, with protective varnish 70 natural solid oak, oiled	04 white powder-coated (textured) 30 basic dark powder-coated (textured)

# Super Fold Table

Jasper Morrison, 2015

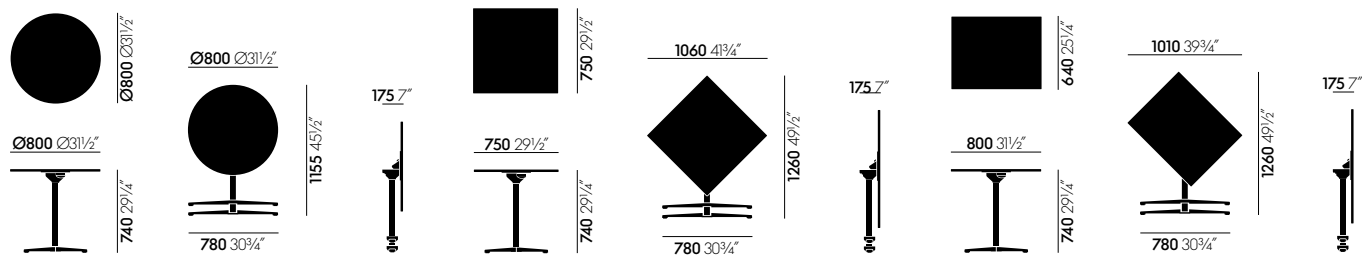

**Table top:** melamine faced in white with smooth straight plastic edge (19 mm), oak veneer (Europe) in natural or dark oak (19 mm) or solid core material with black edge (12 mm) in the colours white or black. Solid core table top in black with anti-fingerprint coating.

**Folding mechanism:** die-cast zinc.

**Column:** powder-coated steel in basic dark.

**Base:** die-cast aluminium.

# Super Fold Table

Jasper Morrison, 2015

**vitra.**

<b>Round table, indoor, Ø 796 mm</b>	Article no.	without VAT in SEK*	with VAT in SEK*
	<b>443 021 01</b>		
white melamine	03	11.440,00	<b>14.300,00</b>
white solid core material	01	12.880,00	<b>16.100,00</b>
black solid core material	30	12.880,00	<b>16.100,00</b>
light oak veneer	17	16.160,00	<b>20.200,00</b>
dark oak veneer	04	16.160,00	<b>20.200,00</b>

<b>Rectangular table, indoor, 640 x 796 mm</b>	Article no.	without VAT in SEK*	with VAT in SEK*
	<b>443 022 01</b>		
melamine white	03	11.440,00	<b>14.300,00</b>
solid core material white	01	12.880,00	<b>16.100,00</b>
solid core material black	30	12.880,00	<b>16.100,00</b>
veneer light oak	17	16.160,00	<b>20.200,00</b>
veneer dark oak	04	16.160,00	<b>20.200,00</b>

<b>Square table, indoor, 750 x 750 mm</b>	Article no.	without VAT in SEK*	with VAT in SEK*
	<b>443 023 01</b>		
melamine white	03	11.440,00	<b>14.300,00</b>
solid core material white	01	12.880,00	<b>16.100,00</b>
solid core material black	30	12.880,00	<b>16.100,00</b>
veneer light oak	17	16.160,00	<b>20.200,00</b>
veneer dark oak	04	16.160,00	<b>20.200,00</b>

# Super Fold Table High

Jasper Morrison, 2015

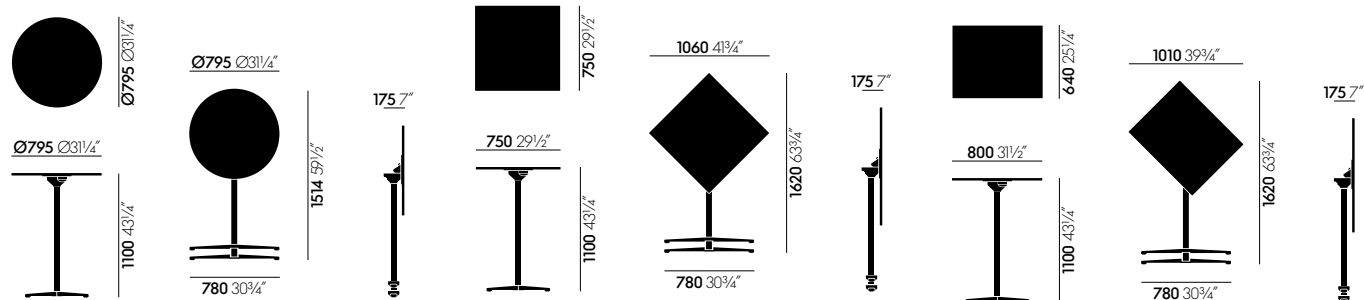

**Table top:** melamine faced in white with smooth straight plastic edge (19 mm), oak veneer (Europe) in natural or dark oak (19 mm) or solid core material with black edge (12 mm) in the colours white or black. Solid core table top in black with anti-fingerprint coating.

**Folding mechanism:** die-cast zinc.

**Column:** powder-coated steel in basic dark.

**Base:** die-cast aluminium.



# Super Fold Table High

Jasper Morrison, 2015

**vitra.**

## Round stand-up table, indoor, Ø 796 mm

	Article no.	without VAT in SEK*	with VAT in SEK*
	<b>443 036 01</b>		
white melamine	03	12.480,00	<b>15.600,00</b>
white solid core material	01	14.160,00	<b>17.700,00</b>
black solid core material	30	14.160,00	<b>17.700,00</b>
dark oak veneer	04	17.280,00	<b>21.600,00</b>
light oak veneer	17	17.280,00	<b>21.600,00</b>

## Square stand-up table, indoor, 750 x 750 mm

	Article no.	without VAT in SEK*	with VAT in SEK*
	<b>443 038 01</b>		
white melamine	03	12.480,00	<b>15.600,00</b>
white solid core material	01	14.160,00	<b>17.700,00</b>
black solid core material	30	14.160,00	<b>17.700,00</b>
dark oak veneer	04	17.280,00	<b>21.600,00</b>
light oak veneer	17	17.280,00	<b>21.600,00</b>

## Rectangular stand-up table, indoor, 640 x 796 mm

	Article no.	without VAT in SEK*	with VAT in SEK*
	<b>443 037 01</b>		
white melamine	03	12.480,00	<b>15.600,00</b>
white solid core material	01	14.160,00	<b>17.700,00</b>
black solid core material	30	14.160,00	<b>17.700,00</b>
dark oak veneer	04	17.280,00	<b>21.600,00</b>
light oak veneer	17	17.280,00	<b>21.600,00</b>

## Table S.A.M. Bois

Jean Prouvé, 1941

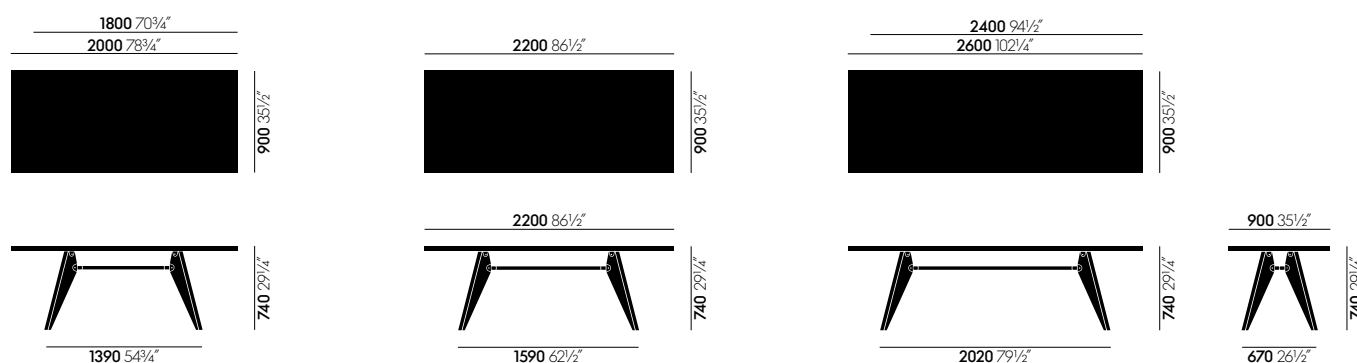

**Table top:** 34 mm thick; solid wood in natural oak with oiled finish, dark stained oak with protective natural lacquer finish, or American walnut with oiled finish.

**Base:** legs matched to table top, solid wood in natural oak with oiled finish, dark stained oak with protective natural lacquer finish, or American walnut with oiled finish; tubular steel crossbar with powder-coated finish (smooth).

**Origin of wood:** oak (*Quercus robur*) from Western Europe and/or Poland; American walnut (*Juglans nigra*) from the USA.

## Table S.A.M. Bois

	Article no.	without VAT in SEK*	with VAT in SEK*
<b>H 740 x W 900 x L 1800 mm</b>	<b>212 028 00</b>		
natural solid oak, oiled	70	44.800,00	<b>56.000,00</b>
dark solid oak, with protective varnish	04	54.080,00	<b>67.600,00</b>
solid American walnut, oiled	75	63.680,00	<b>79.600,00</b>
<b>H 740 x W 900 x L 2000 mm</b>	<b>212 029 00</b>		
natural solid oak, oiled	70	48.160,00	<b>60.200,00</b>
dark solid oak, with protective varnish	04	56.400,00	<b>70.500,00</b>
solid American walnut, oiled	75	73.680,00	<b>92.100,00</b>
<b>H 740 x W 900 x L 2200 mm</b>	<b>212 030 00</b>		
natural solid oak, oiled	70	49.920,00	<b>62.400,00</b>
dark solid oak, with protective varnish	04	58.720,00	<b>73.400,00</b>
solid American walnut, oiled	75	78.800,00	<b>98.500,00</b>
<b>H 740 x W 900 x L 2400 mm</b>	<b>212 031 00</b>		
natural solid oak, oiled	70	58.000,00	<b>72.500,00</b>
dark solid oak, with protective varnish	04	68.000,00	<b>85.000,00</b>
solid American walnut, oiled	75	84.240,00	<b>105.300,00</b>
<b>H 740 x W 900 x L 2600 mm</b>	<b>212 032 00</b>		
natural solid oak, oiled	70	67.200,00	<b>84.000,00</b>
dark solid oak, with protective varnish	04	77.600,00	<b>97.000,00</b>
solid American walnut, oiled	75	88.880,00	<b>111.100,00</b>

# Trapèze

Jean Prouvé, 1950/1954

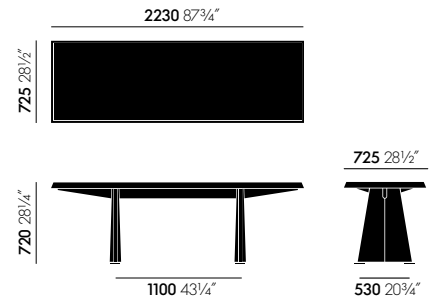

**Table top:** high-pressure laminate, black surface coating.

**Base (legs and crossbeam):** bent sheet steel, powder-coated in black.

## Trapèze

H 720 x W 2230 x D 725 mm

black HPL

Article no.	without VAT in SEK*	with VAT in SEK*
412 391 00	55.920,00	69.900,00

## Desks



Compas Direction  
Jean Prouvé  
188



Eames Desk Unit EDU  
Charles & Ray Eames  
189



Home Desk  
George Nelson  
190

Office and conference chairs (swivel)

Chairs

Tables

**Desks**



Public waiting areas

Lounge chairs and armchairs

Sofas

Coffee and side tables

Stools and benches

Storage and partition elements

**Accessories**

Living, dining, decorative objects, home office,  
clocks, lighting, publications

Quick Ship programme

General terms, conditions  
and information

# Compas Direction

Jean Prouvé, 1953

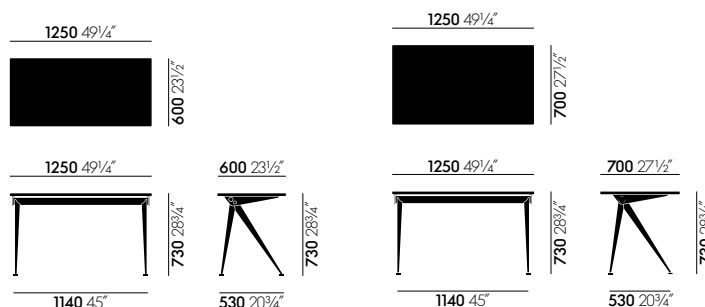

**Table top:** solid wood in natural oak with oiled finish, dark stained oak with protective natural lacquer finish, or American walnut with oiled finish.

**Base:** bent sheet steel, powder-coated finish (smooth).

**Note:** the steel frame in Métal Brut has a raw irregular surface protected by a transparent powder coating.

**Origin of wood:** oak (*Quercus robur*) from Western Europe and/or Poland; American walnut (*Juglans nigra*) from the USA.

## Compas Direction

	Article no.	without VAT in SEK*	with VAT in SEK*
<b>1250 x 600 mm</b>	<b>212 027 00</b>		
solid natural oak, oiled	70	25.320,00	<b>31.650,00</b>
solid dark oak, with protective varnish	04	25.320,00	<b>31.650,00</b>
solid American walnut, oiled	75	27.560,00	<b>34.450,00</b>
<b>Surcharges base</b>			
Colour group 1		0,00	<b>0,00</b>
Colour group 2		1.352,00	<b>1.690,00</b>
<b>1250 x 700 mm</b>	<b>212 060 00</b>		
solid natural oak, oiled	70	26.200,00	<b>32.750,00</b>
solid dark oak, with protective varnish	04	26.200,00	<b>32.750,00</b>
solid American walnut, oiled	75	28.440,00	<b>35.550,00</b>
<b>Surcharges base</b>			
Base chocolate powder-coated (smooth), Color group 1	40	0,00	<b>0,00</b>
Colour group 2		1.352,00	<b>1.690,00</b>

### Base frame Colour group 1

06 Japanese red powder-coated (smooth)  
12 deep black powder-coated (smooth)  
88 Prouvé Blanc Colombe (Ecrú) powder-coated (smooth)

### Base frame Colour group 2

13 Prouvé Gris Vermeer powder-coated (smooth)  
14 Prouvé Bleu Dynastie powder-coated (smooth)  
18 Prouvé Blé Vert powder-coated (smooth)  
41 Prouvé Bleu Marcoule powder-coated (smooth)  
94 Prouvé Métal Brut powder-coated (transparent, smooth)

# Eames Desk Unit EDU

Charles & Ray Eames, 1949

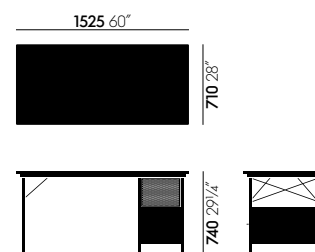

**Table top:** plywood with birch veneer (Poland and Finland).

**Metal surfaces:** black powder-coated finish.

**Panels:** powder-coated aluminium.

**Shelves:** maple plywood with birch face veneer (Poland and Finland), transparent lacquer finish.

**Legs:** individual levelling adjustment.

**Applications:** recommended for residential use only.

## EDU

Article no.	without VAT in SEK*	with VAT in SEK*
<b>213 025 11</b>	14.680,00	<b>18.350,00</b>

# Home Desk

George Nelson, 1958

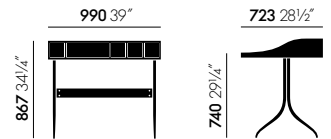

**Top surfaces:** high-pressure laminate in white, wooden side sections in walnut veneer.

**Shelf dividers:** polystyrene.

**Base:** swaged metal tubing, chrome-plated.

**Range of use:** recommended for residential use only.

## Home Desk

		Article no.	without VAT in SEK*	with VAT in SEK*
walnut veneer	white HPL	412 503 00	34.320,00	42.900,00





## Public Waiting



.04 beam seating  
Maarten Van Severen  
194



AIRLINE  
Norman Foster  
196



EPAC beam seating  
Charles & Ray Eames  
200



EPSC beam seating  
Charles & Ray Eames  
202



Tandem Seating  
Charles & Ray Eames  
204



HAL beam seating  
Jasper Morrison  
206



Meda Gate  
Alberto Meda  
209



Soft Wait  
Barber & Osgerby  
Prices and configurations can be found in OSC pro and pCon.



Soft Work  
Barber & Osgerby  
Prices and configurations can be found in OSC pro and pCon.

---

## Chairs with row connectors in other chapters



DSS, DSS-N  
Charles & Ray Eames  
100



MedaSlim  
Alberto Meda  
131

Office and conference chairs (swivel)

Chairs

Tables

Desks

**Public waiting areas**

Lounge chairs and armchairs

Sofas

Coffee and side tables

Stools and benches

Storage and partition elements

**Accessories**

Living, dining, decorative objects, home office,  
clocks, lighting, publications

Quick Ship programme

General terms, conditions  
and information



# .04 beam seating

Maarten Van Severen, 2000

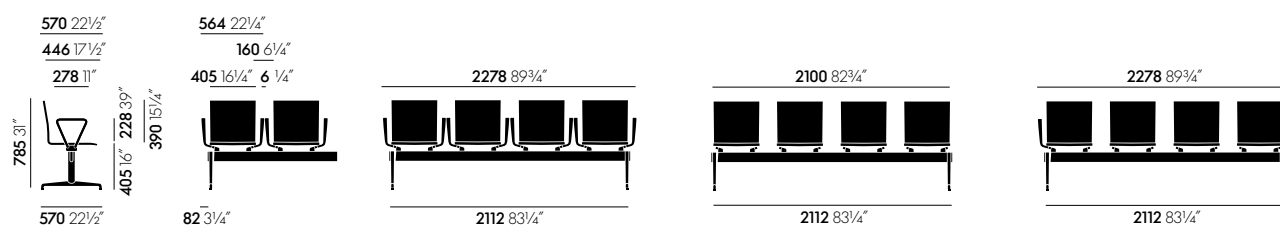

**Backrest and seat:** flexible backrest with integrated leaf springs. Polyurethane integral foam seat shell with upholstered effect, self-supporting on a steel frame.

**Armrests:** with or without armrests in integral foam.

**Table units:** black solid core material.

**Base:** T-beam and aluminium legs epoxy-coated. Equipped with plastic glides for carpet or anti-slip glides for hard floors.

# .04 beam seating

Maarten Van Severen, 2000

<b>.04 seat unit</b>	Article no.	without VAT in SEK*	with VAT in SEK*
	<b>440 084 00</b>		
AO - without armrests	01	5.432,00	<b>6.790,00</b>
AR - with 1 armrest installed on the right	02	6.040,00	<b>7.550,00</b>
AL - with 1 armrest installed on the left	03	6.040,00	<b>7.550,00</b>
AB - with 2 armrests	04	6.760,00	<b>8.450,00</b>

<b>.04 stretchers</b>	Article no.	without VAT in SEK*	with VAT in SEK*
	<b>440 086 00</b>		
AO with 2 units	02	5.720,00	<b>7.150,00</b>
AR with 3 units	03	6.632,00	<b>8.290,00</b>
AL with 4 units	04	7.512,00	<b>9.390,00</b>
AB with 5 units	05	8.240,00	<b>10.300,00</b>

<b>.04 table unit</b>	Article no.	without VAT in SEK*	with VAT in SEK*
	<b>440 085 00</b>		
compact laminate black, 40 x 40 cm	01	3.912,00	<b>4.890,00</b>

### Example of a three-seater

1 x AO	<b>440 084 01 01</b>	Unit without armrest
1 x T	<b>440 085 00</b>	Table unit
1 x AL	<b>440 084 00 02</b>	Unit with one armrest fitted on right
1 x	<b>440 086 00 03</b>	Unit with one armrest fitted on left
1 x	<b>440 086 00</b>	Stretcher for four units incl. two legs

The configuration is defined from right to left in sitting position.

The following combinations are possible using the table element  
(version with and without armrests):



### Seat shell

01 basic dark  
10 bright red

### Glides

04 glides for carpet  
09 anti-slip glides

# Airline

Norman Foster, 1998



Seat and back in polyurethane integral foam

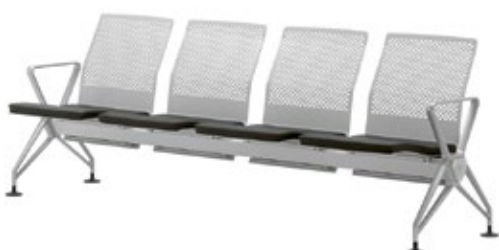

Back perforated, seat upholstered



Seat and back in maple veneer

All measurements are pursuant to EN 1335-1:2000  
More detailed information is found in the chapter 'Explanation of measurements'.

**Seat and backrest elements available in four versions:** moulded maple plywood (clear lacquer finish); perforated steel; steel with padding (black vinyl cover); polyurethane integral skin foam (robust seat shell with upholstered effect, cantilevered on steel frame).

**Armrests:** die-cast aluminium, silver-colour coating.

**Table units:** black solid core material.

**Base:** triangular aluminium profile as the loadbearing element, anodised in silver-grey; die-cast aluminium legs, silver-colour coating; plastic glides for carpet.

**Optional:** side table with a top made of black solid core material.

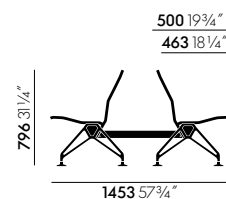
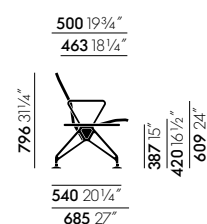
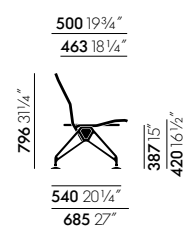

# Airline

## Norman Foster, 1998

<b>Seat and back</b>	Article no.	without VAT in SEK*	with VAT in SEK*
<b>418 100 00</b>			
S1 - seat and backrest perforated, non-upholstered	01	9.440,00	<b>11.800,00</b>
S3 - seat sheet steal non-perforated, upholstered; backrest perforated	03	10.720,00	<b>13.400,00</b>
S2 - seat and backrest sheet steel non-perforated, upholstered	02	11.840,00	<b>14.800,00</b>
W1 - seat and backrest in maple veneer	11	9.520,00	<b>11.900,00</b>
P1 - seat and backrest in polyurethane integral foam black	21	9.280,00	<b>11.600,00</b>
P3 - seat polyurethane integral foam; backrest maple veneer	23	9.280,00	<b>11.600,00</b>
<hr/>			
<b>Stretcher</b>	Article no.	without VAT in SEK*	with VAT in SEK*
<b>418 101 00</b>			
B1 - 2 seat units	01	3.640,00	<b>4.550,00</b>
B2 - 3 seat units	02	4.920,00	<b>6.150,00</b>
B3 - 4 seat units	03	6.232,00	<b>7.790,00</b>
<hr/>			
<b>Leg</b>	Article no.	without VAT in SEK*	with VAT in SEK*
<b>418 102 00</b>			
F1 - without armrest, with bridge	01	3.480,00	<b>4.350,00</b>
F2 - with armrest	02	4.080,00	<b>5.100,00</b>
<hr/>			
<b>Armrest between seating units</b>	Article no.	without VAT in SEK*	with VAT in SEK*
<b>418 103 00</b>			
A1 - silver grey with fitting for double row connection	01	2.632,00	<b>3.290,00</b>
A2 - silver grey without fitting for double row connection, with fixation component	02	2.680,00	<b>3.350,00</b>
<hr/>			
<b>Table unit</b>	Article no.	without VAT in SEK*	with VAT in SEK*
<b>418 104 00</b>			
TS - 300 x 500 mm, black	01	3.640,00	<b>4.550,00</b>
TB - 500 x 500 mm, black	02	5.080,00	<b>6.350,00</b>
<hr/>			
<b>Double row connection</b>	Article no.	without VAT in SEK*	with VAT in SEK*
<b>418 007 00</b>			
L1 - with connection to the armrest	01	896,00	<b>1.120,00</b>
L2 - with connection to stretcher	02	1.800,00	<b>2.250,00</b>
<hr/>			
<b>Side table</b>	Article no.	without VAT in SEK*	with VAT in SEK*
<b>418 008 00</b>			
textured silver grey	31	19.040,00	<b>23.800,00</b>

# Airline

Norman Foster, 1998

**MW:** Factory assembled

**MB:** Assembled on site (assembly equipment on request)

## Possible configurations:

- single row
- double row (back to back)
- single row with alternately positioned seats facing front and back ("kissing position")

## Examples of orders for versions with integrated foam seat and back:

3 x P1	418 100 00 21	Integrated foam seat and back
1 x B3	418 101 00 03	base frame for four seating units
2 x F2	418 102 00 02	Leg with armrest
1 x TB	418 104 00 02	black compact laminate table unit

The configuration is defined from right to left in sitting position.

Sample configuration:

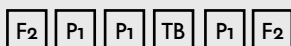

## Notes:

Only the TS component can be used as a side table.

With two side tables the minimum configuration consists of three seating units.



A maximum of four elements (seating/table unit TB) and two side table units (TS) can be mounted on a stretcher with two legs. A double bench is always made up of at least two double connections (L1 or L2).

**In the case of assembly ex works be sure to state the configuration sitting from right to left (see order example above).**



# Airline

Norman Foster, 1998

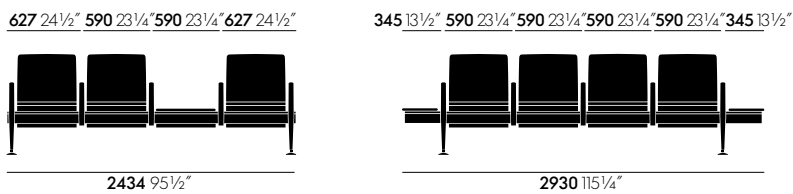
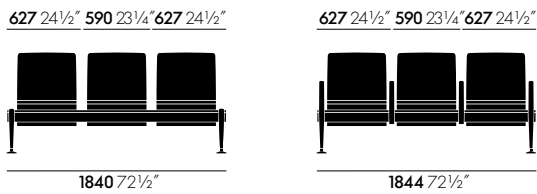
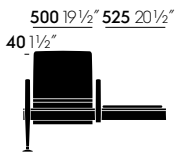
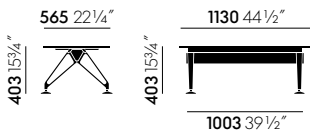
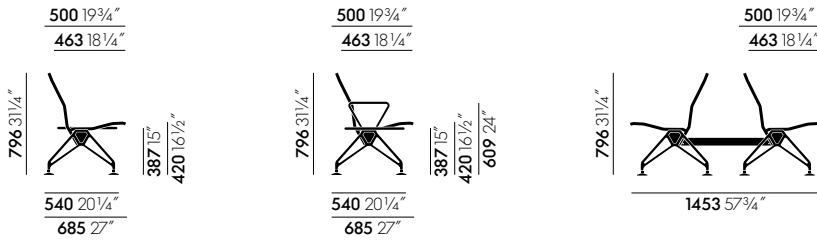

# Eames Plastic Armchair beam seating

Charles & Ray Eames, 1950

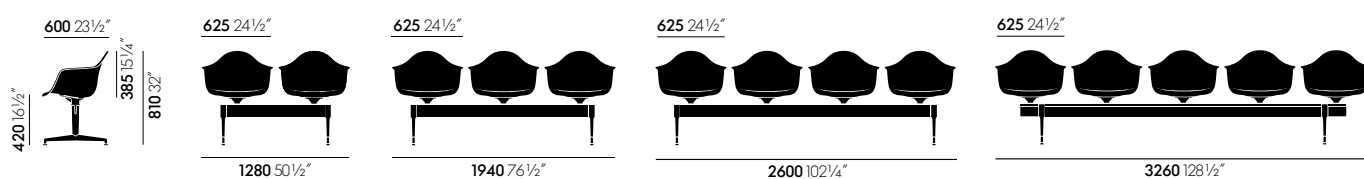

All measurements are pursuant to EN 1335-1:2000

More detailed information is found in the chapter 'Explanation of measurements'.

**Seat shell:** dyed-through polypropylene. All models are available with a seat cushion (screwed to the seat shell) or full upholstery. The fully upholstered version has moulded polyurethane foam padding covered in fabric, attached to the shell with a welted edge. Different shell and upholstery colours and various bases provide a multitude of possible combinations.

**Options:** the Eames Plastic Chair is available as a visitor chair, dining chair, rocking chair, swivel chair or in stacking versions and with ganging brackets for row seating. Beam-mounted shells are suited for use in waiting areas.

**Table unit:** black solid core material (560 x 430 mm).

**Base:** two-legged beam support in different lengths accommodates 2 to 5 chair shells or table units. T-beam: epoxy-coated in basic dark, polished aluminium legs. Fitted with plastic glides for carpet or anti-skid felt glides for hard floors.

# Eames Plastic Armchair beam seating

## Charles & Ray Eames, 1950

**vitra.**

### Eames Plastic Armchair on beam

	Article no.	without VAT in SEK*	with VAT in SEK*
<b>without upholstery</b>	<b>440 119 22</b>		
2 seat units, 0 table units	51	18.720,00	<b>23.400,00</b>
2 seat units, 1 table unit	01	22.400,00	<b>28.000,00</b>
2 seat units, 2 table units	31	26.880,00	<b>33.600,00</b>
3 seat units, 0 table units	71	22.000,00	<b>27.500,00</b>
3 seat units, 1 table unit	11	26.400,00	<b>33.000,00</b>
3 seat units, 2 table units	41	30.720,00	<b>38.400,00</b>
4 seat units, 0 table units	81	26.320,00	<b>32.900,00</b>
4 seat units, 1 table unit	21	30.320,00	<b>37.900,00</b>
5 seat units, 0 table units	91	29.840,00	<b>37.300,00</b>
<b>with seat upholstery fabric F60</b>			
2 seat units, 0 table units	52	20.720,00	<b>25.900,00</b>
2 seat units, 1 table unit	02	24.640,00	<b>30.800,00</b>
2 seat units, 2 table units	32	29.040,00	<b>36.300,00</b>
3 seat units, 0 table units	72	25.120,00	<b>31.400,00</b>
3 seat units, 1 table unit	12	29.440,00	<b>36.800,00</b>
3 seat units, 2 table units	42	33.360,00	<b>41.700,00</b>
4 seat units, 0 table units	82	30.320,00	<b>37.900,00</b>
4 seat units, 1 table unit	22	34.000,00	<b>42.500,00</b>
5 seat units, 0 table units	92	34.640,00	<b>43.300,00</b>
<b>with full upholstery fabric F60</b>	<b>440 169 00</b>		
2 seat units, 0 table units	53	26.320,00	<b>32.900,00</b>
2 seat units, 1 table unit	03	30.320,00	<b>37.900,00</b>
2 seat units, 2 table units	33	34.640,00	<b>43.300,00</b>
3 seat units, 0 table units	73	33.360,00	<b>41.700,00</b>
3 seat units, 1 table unit	13	38.000,00	<b>47.500,00</b>
3 seat units, 2 table units	43	41.760,00	<b>52.200,00</b>
4 seat units, 0 table units	83	41.200,00	<b>51.500,00</b>
4 seat units, 1 table unit	23	44.960,00	<b>56.200,00</b>
5 seat units, 0 table units	93	48.320,00	<b>60.400,00</b>

#### Fabric F60

#### Seat shell

#### Edge

#### Glides

Hopsak	03 poppy red	34 mustard	01 basic dark	04 glides for carpet
	04 white	41 pale rose	04 white	09 anti-slip glides
	11 pebble	42 green		
	12 deep black	43 rusty orange		
	23 ice grey	48 forest		
	24 light grey	56 granite grey		
	26 sunlight	83 sea blue		

# Eames Plastic Side Chair beam seating

Charles & Ray Eames, 1950

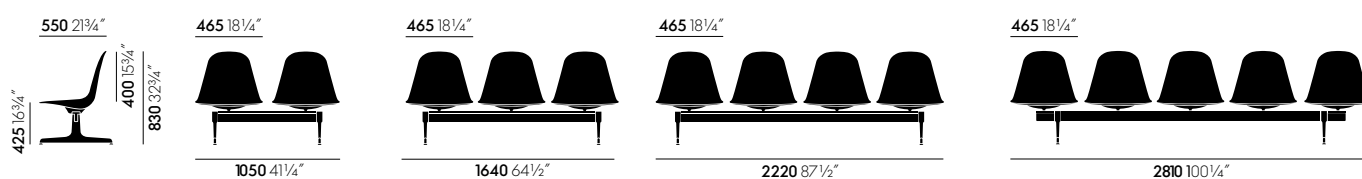

**Seat shell:** dyed-through polypropylene. All models are available with a seat cushion (screwed to the seat shell) or full upholstery. The fully upholstered version has moulded polyurethane foam padding covered in fabric, attached to the shell with a welted edge. Different shell and upholstery colours and various bases provide a multitude of possible combinations.

**Options:** the Eames Plastic Chair is available as a visitor chair, dining chair, rocking chair, swivel chair or in stacking versions and with ganging brackets for row seating. Beam-mounted shells are suited for use in waiting areas.

**Table units:** black solid core material (560 x 430 mm).

**Base:** two-legged base beams in different lengths accommodate 2 to 5 chair shells or table units. T-beam, epoxy-coated in basic dark, polished aluminium legs. Equipped with plastic glides for carpet or anti-skid felt glides for hard floors.

# Eames Plastic Side Chair beam seating

## Charles & Ray Eames, 1950

vitra.

<b>Eames Plastic Side Chair on beam</b>	Article no.	without VAT in SEK*	with VAT in SEK*
<b>without upholstery</b>	<b>440 027 00</b>		
2 seating units / 0 table unit	02	15.920,00	<b>19.900,00</b>
2 seating units / 1 table unit	21	19.760,00	<b>24.700,00</b>
2 seating un. / 2 table units	22	23.680,00	<b>29.600,00</b>
3 seating units / 0 table unit	03	18.160,00	<b>22.700,00</b>
3 seating units / 1 table unit	31	22.400,00	<b>28.000,00</b>
3 seating un. / 2 table units	32	26.320,00	<b>32.900,00</b>
4 seating units / 0 table unit	04	20.720,00	<b>25.900,00</b>
4 seating units / 1 table unit	41	24.640,00	<b>30.800,00</b>
5 seating units / 0 table unit	05	23.200,00	<b>29.000,00</b>
<b>with seat upholstery fabric F60</b>	<b>440 177 00</b>		
2 seating units / 0 table unit	02	18.160,00	<b>22.700,00</b>
2 seating units / 1 table unit	21	21.920,00	<b>27.400,00</b>
3 seating units / 0 table unit	03	21.360,00	<b>26.700,00</b>
3 seating units / 1 table unit	31	25.120,00	<b>31.400,00</b>
3 seating un. / 2 table units	32	29.040,00	<b>36.300,00</b>
4 seating units / 0 table unit	04	24.640,00	<b>30.800,00</b>
4 seating units / 1 table unit	41	28.480,00	<b>35.600,00</b>
5 seating units / 0 table unit	05	28.000,00	<b>35.000,00</b>
<b>with full upholstery fabric F60</b>	<b>440 157 00</b>		
2 seating units / 0 table unit	02	21.360,00	<b>26.700,00</b>
2 seating units / 1 table unit	21	25.280,00	<b>31.600,00</b>
3 seating units / 0 table unit	03	26.880,00	<b>33.600,00</b>
3 seating units / 1 table unit	31	30.800,00	<b>38.500,00</b>
3 seating un. / 2 table units	32	35.120,00	<b>43.900,00</b>
4 seating units / 0 table unit	04	32.480,00	<b>40.600,00</b>
4 seating units / 1 table unit	41	36.160,00	<b>45.200,00</b>
5 seating units / 0 table unit	05	38.000,00	<b>47.500,00</b>

Fabric F60	Seat shell	Edge	Glides
Hopsak	03 poppy red 04 white 11 pebble 12 deep black 23 ice grey 24 light grey 26 sunlight	34 mustard 41 pale rose 42 green 43 rusty orange 48 forest 56 granite grey 83 sea blue	01 basic dark 04 white 04 glides for carpet 09 anti-slip glides

# Eames Tandem Seating ETS

Charles & Ray Eames, 1962

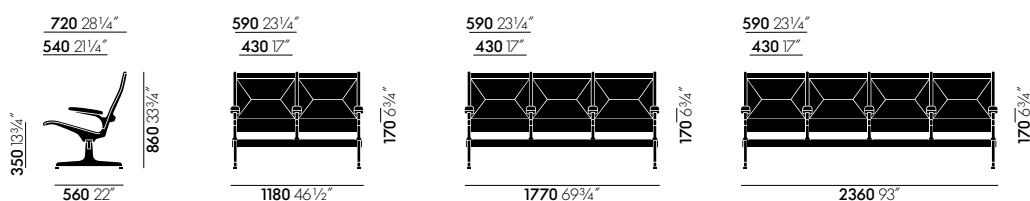

**Backrest and seat:** seat and back panels covered in vinyl or leather, padded sections with welded seams. Frame and armrest supports: chrome-plated die-cast aluminium.

**Armrests:** frame supports in chrome-plated die-cast aluminium, armrest pads made of integral polyurethane foam.

**Base:** substructure with T-beam in basic dark. T-legs in chrome-plated die-cast aluminium. Equipped with plastic glides for carpet or non-slip felt glides for hard floors.

# Eames Tandem Seating ETS

Charles & Ray Eames, 1962

<b>Basic seating unit TS-12</b>	Article no.	without VAT in SEK*	with VAT in SEK*
<b>2 armrests</b>	<b>962 037 00</b>		
Vinyl		36.720,00	<b>45.900,00</b>
Leather L20		43.120,00	<b>53.900,00</b>

<b>Additional seat unit TS-11</b>	Article no.	without VAT in SEK*	with VAT in SEK*
	<b>962 038 00</b>		
Vinyl		24.080,00	<b>30.100,00</b>
Leather L20		30.240,00	<b>37.800,00</b>

<b>TS single row</b>	Article no.	without VAT in SEK*	with VAT in SEK*
<b>TS-1 for 1 unit</b>	<b>926 018 00</b>		
Base chromed	30	12.640,00	<b>15.800,00</b>
<b>TS-2 for 2 units</b>	<b>926 019 00</b>		
Base chromed	30	14.720,00	<b>18.400,00</b>
<b>TS-3 for 3 units</b>	<b>926 020 00</b>		
Base chromed	30	16.800,00	<b>21.000,00</b>
<b>TS-4 for 4 units</b>	<b>926 021 00</b>		
Base chromed	30	18.560,00	<b>23.200,00</b>

<b>Leather L20</b>	<b>Vinyl ETS</b>	<b>Glides</b>
Leather	76 antra II	04 glides for carpet 09 anti-slip glides

# HAL beam seating

Jasper Morrison, 2019

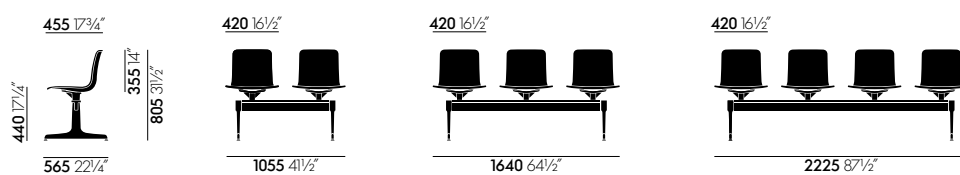

All measurements are pursuant to EN 1335-1:2000  
 More detailed information is found in the chapter 'Explanation of measurements'.

**Seat shell:** dyed-through recycled polypropylene or plywood.

**Table unit:** black solid core material (560 x 430 mm).

**Base:** two-legged beam support in different lengths accommodates 2 to 5 chair shells or table units. T-beam with powder-coated finish, aluminium legs. Equipped with plastic glides for carpet or non-slip glides for hard floors.



# HAL beam seating

Jasper Morrison, 2019

HAL beam seating	Article no.	without VAT in SEK*	with VAT in SEK*
	<b>440 525 00</b>		
2 seat units or table units	02	13.344,00	<b>16.680,00</b>
3 seat units or table units	03	16.288,00	<b>20.360,00</b>
4 seat units or table units	04	18.392,00	<b>22.990,00</b>
5 seat units or table units	05	20.272,00	<b>25.340,00</b>
<b>2-seater bench</b>			
<b>Position 1</b>			
seat, recycled polypropylene	01	848,00	<b>1.060,00</b>
seat, plywood	02	2.832,00	<b>3.540,00</b>
table unit, solid core mat.	03	1.352,00	<b>1.690,00</b>
<b>Position 2</b>			
seat, recycled polypropylene	01	848,00	<b>1.060,00</b>
seat, plywood	02	2.832,00	<b>3.540,00</b>
table unit, solid core mat.	03	1.352,00	<b>1.690,00</b>
<b>3-seater bench</b>			
<b>Position 1</b>			
seat, recycled polypropylene	01	848,00	<b>1.060,00</b>
seat, plywood	02	2.832,00	<b>3.540,00</b>
table unit, solid core mat.	03	1.352,00	<b>1.690,00</b>
<b>Position 2</b>			
seat, recycled polypropylene	01	848,00	<b>1.060,00</b>
seat, plywood	02	2.832,00	<b>3.540,00</b>
table unit, solid core mat.	03	1.352,00	<b>1.690,00</b>
<b>Position 3</b>			
seat, recycled polypropylene	01	848,00	<b>1.060,00</b>
seat, plywood	02	2.832,00	<b>3.540,00</b>
table unit, solid core mat.	03	1.352,00	<b>1.690,00</b>
<b>4-seater bench</b>			
<b>Position 1</b>			
seat, recycled polypropylene	01	848,00	<b>1.060,00</b>
seat, plywood	02	2.832,00	<b>3.540,00</b>
table unit, solid core mat.	03	1.352,00	<b>1.690,00</b>
<b>Position 2</b>			
seat, recycled polypropylene	01	848,00	<b>1.060,00</b>
seat, plywood	02	2.832,00	<b>3.540,00</b>
table unit, solid core mat.	03	1.352,00	<b>1.690,00</b>
<b>Position 3</b>			
seat, recycled polypropylene	01	848,00	<b>1.060,00</b>
seat, plywood	02	2.832,00	<b>3.540,00</b>
table unit, solid core mat.	03	1.352,00	<b>1.690,00</b>
<b>Position 4</b>			
seat, recycled polypropylene	01	848,00	<b>1.060,00</b>
seat, plywood	02	2.832,00	<b>3.540,00</b>
table unit, solid core mat.	03	1.352,00	<b>1.690,00</b>

Seat shell HAL RE	Seat shell HAL Ply	Glides
12 deep black RE	04 dark oak, with protective varnish	04 glides for carpet
14 ivy RE	10 natural oak, with protective varnish	09 anti-slip glides
23 ice grey RE		
29 brick RE		
31 warm grey RE		
35 basalt RE		
85 cotton white RE		
86 cardboard RE		

# HAL beam seating

Jasper Morrison, 2019

**vitra.**

HAL beam seating	Article no.	without VAT in SEK*	with VAT in SEK*
<b>5-seater bench</b>			
<b>Position 1</b>			
seat, recycled polypropylene	01	848,00	<b>1.060,00</b>
seat, plywood	02	2.832,00	<b>3.540,00</b>
table unit, solid core mat.	03	1.352,00	<b>1.690,00</b>
<b>Position 2</b>			
seat, recycled polypropylene	01	848,00	<b>1.060,00</b>
seat, plywood	02	2.832,00	<b>3.540,00</b>
table unit, solid core mat.	03	1.352,00	<b>1.690,00</b>
<b>Position 3</b>			
seat, recycled polypropylene	01	848,00	<b>1.060,00</b>
seat, plywood	02	2.832,00	<b>3.540,00</b>
table unit, solid core mat.	03	1.352,00	<b>1.690,00</b>
<b>Position 4</b>			
seat, recycled polypropylene	01	848,00	<b>1.060,00</b>
seat, plywood	02	2.832,00	<b>3.540,00</b>
table unit, solid core mat.	03	1.352,00	<b>1.690,00</b>
<b>Position 5</b>			
seat, recycled polypropylene	01	848,00	<b>1.060,00</b>
seat, plywood	02	2.832,00	<b>3.540,00</b>
table unit, solid core mat.	03	1.352,00	<b>1.690,00</b>

#### Seat shell HAL RE

12 deep black RE  
14 ivy RE  
23 ice grey RE  
29 brick RE  
31 warm grey RE  
35 basalt RE  
85 cotton white RE  
86 cardboard RE

#### Seat shell HAL Ply

04 dark oak, with protective varnish  
10 natural oak, with protective varnish

#### Glides

04 glides for carpet  
09 anti-slip glides

# Meda Gate

Alberto Meda, 2011

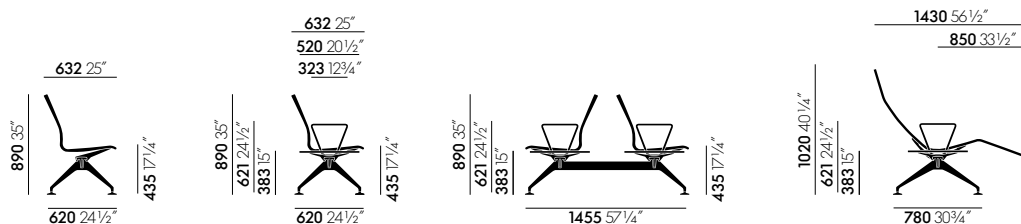

All measurements are pursuant to EN 1335-1:2000  
 More detailed information is found in the chapter 'Explanation of measurements'.

**Seat shell:** Polyurethane integral foam (robust seat shell with upholstered effect, self-supporting on a steel frame) or split leather.

**Armrests:** Ring armrests of die-cast aluminium. With silver coating or polished.

**Base:** Aluminium T support profile. Silver grey natural anodised aluminium or polished anodised aluminium. Die-cast aluminium legs. Silver coating or polished.

**Table unit:** Made of black solid core laminate.

**Note:** A supporting beam with 2 legs can accommodate a maximum of 5 large elements (seat/table elements) and 2 lateral table elements. For the configuration of the bench, please indicate the positions from left to right as viewed from the front (see ordering example below).

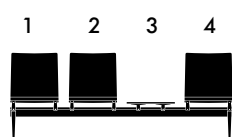

Position 1: seat  
 Position 2: seat  
 Position 3: table  
 Position 4: seat

# Meda Gate

Alberto Meda, 2011

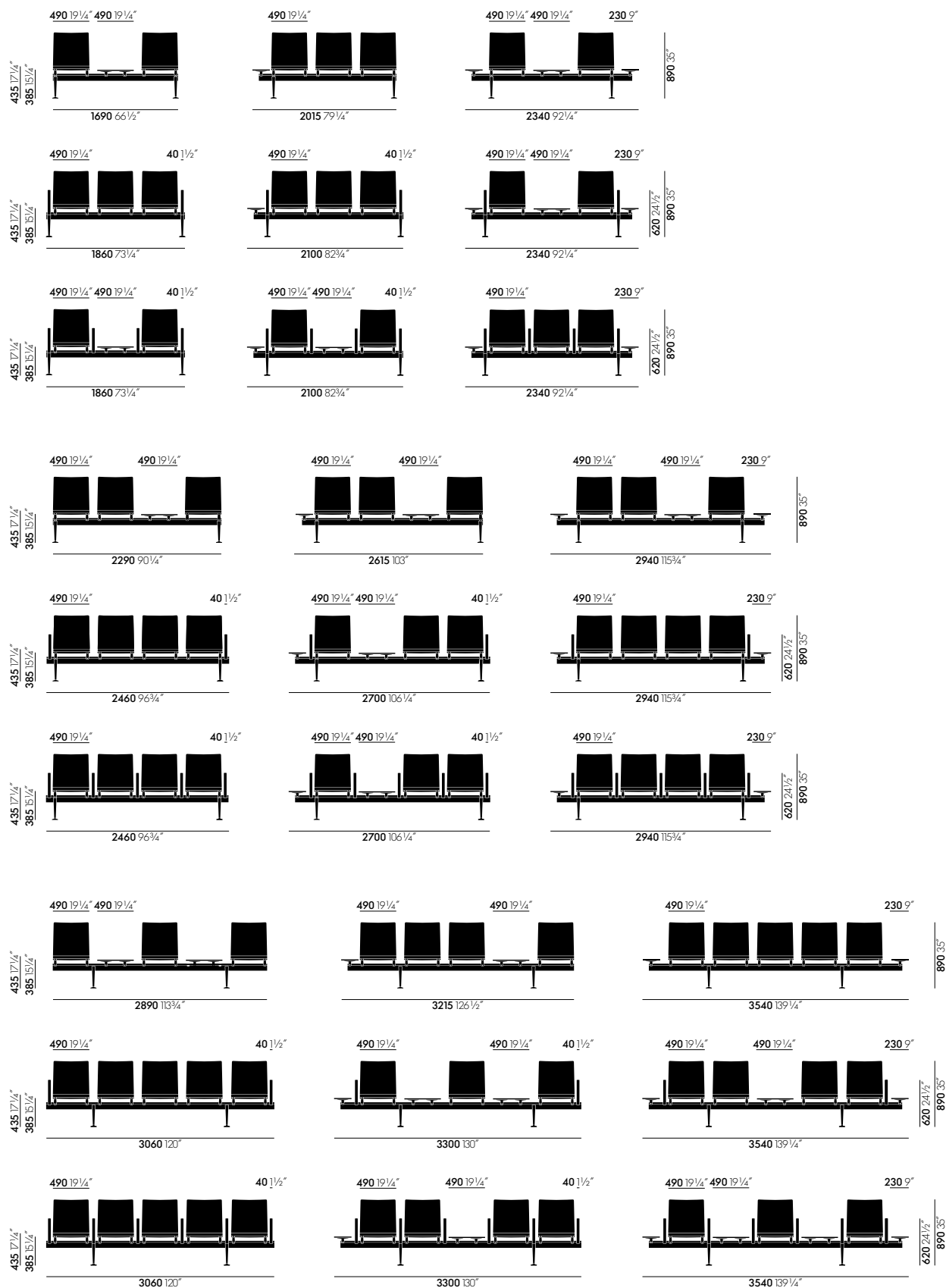

# Meda Gate

Alberto Meda, 2011

vitra.

<b>2 recliners with 3 table units (1x 490 x 520 mm / 2x 230 x 520 mm), with armrests</b>	Article no.	without VAT in SEK*	with VAT in SEK*
		<b>418 205 00</b>	
Seat polyurethane foam, support profile anodised natural, legs coated	11	66.720,00	<b>83.400,00</b>
Seat leather, support profile anodised gloss, legs polished	22	86.160,00	<b>107.700,00</b>

<b>Four-seater double bench with armrests</b>	Article no.	without VAT in SEK*	with VAT in SEK*
		<b>418 204 00</b>	
Seat polyurethane foam, support profile anodised natural, legs coated	11	118.080,00	<b>147.600,00</b>
Seat leather, support profile anodised gloss, legs polished	22	174.800,00	<b>218.500,00</b>

<b>Three-seater bench</b>	Article no.	without VAT in SEK*	with VAT in SEK*
		<b>418 220 00</b>	
<b>Position 1</b>			
seat polyurethane integral foam	01	<b>9.920,00</b>	<b>12.400,00</b>
seat leather	02	15.280,00	<b>19.100,00</b>
table	03	6.712,00	<b>8.390,00</b>
<b>Position 2</b>			
seat polyurethane integral foam	01	<b>9.920,00</b>	<b>12.400,00</b>
seat leather	02	15.280,00	<b>19.100,00</b>
table	03	6.712,00	<b>8.390,00</b>
<b>Position 3</b>			
seat polyurethane integral foam	01	<b>9.920,00</b>	<b>12.400,00</b>
seat leather	02	15.280,00	<b>19.100,00</b>
table	03	6.712,00	<b>8.390,00</b>
<b>Base and support profile</b>			
powder-coated and natural anodised	01	<b>11.760,00</b>	<b>14.700,00</b>
polished/ gloss anodised	02	17.760,00	<b>22.200,00</b>
<b>Armrests</b>			
none	00	<b>0,00</b>	<b>0,00</b>
only outside	01	2.800,00	<b>3.500,00</b>
at all seats	02	5.560,00	<b>6.950,00</b>
<b>Table unit lateral</b>			
none	00	<b>0,00</b>	<b>0,00</b>
left (view from the front)	01	3.720,00	<b>4.650,00</b>
right (view from the front)	02	3.720,00	<b>4.650,00</b>
both sides	03	7.320,00	<b>9.150,00</b>
	<b>Basic price:</b>	<b>41.520,00</b>	<b>51.900,00</b>

#### Seat shell, polyurethane

01 basic dark  
40 chocolate

#### Seat shell, leather Liso

66 nero  
68 chocolate

#### Glides

04 glides for carpet  
09 anti-slip glides

# Meda Gate

Alberto Meda, 2011

vitra.

	Article no.	without VAT in SEK*	with VAT in SEK*
<b>Four-seater bench</b>			
		<b>418 222 00</b>	
<b>Position 1</b>			
seat polyurethane integral foam	01	<b>9.920,00</b>	<b>12.400,00</b>
seat leather	02	15.280,00	<b>19.100,00</b>
table	03	6.712,00	<b>8.390,00</b>
<b>Position 2</b>			
seat polyurethane integral foam	01	<b>9.920,00</b>	<b>12.400,00</b>
seat leather	02	15.280,00	<b>19.100,00</b>
table	03	6.712,00	<b>8.390,00</b>
<b>Position 3</b>			
seat polyurethane integral foam	01	<b>9.920,00</b>	<b>12.400,00</b>
seat leather	02	15.280,00	<b>19.100,00</b>
table	03	6.712,00	<b>8.390,00</b>
<b>Position 4</b>			
seat polyurethane integral foam	01	<b>9.920,00</b>	<b>12.400,00</b>
seat leather	02	15.280,00	<b>19.100,00</b>
table	03	6.712,00	<b>8.390,00</b>
<b>Base and support profile</b>			
powder-coated and natural anodised	01	<b>12.800,00</b>	<b>16.000,00</b>
polished/ gloss anodised	02	19.440,00	<b>24.300,00</b>
<b>Armrests</b>			
none	00	0,00	<b>0,00</b>
only outside	01	2.800,00	<b>3.500,00</b>
at all seats	02	6.840,00	<b>8.550,00</b>
<b>Table unit lateral</b>			
none	00	<b>0,00</b>	<b>0,00</b>
left (view from the front)	01	3.720,00	<b>4.650,00</b>
right (view from the front)	02	3.720,00	<b>4.650,00</b>
both sides	03	7.320,00	<b>9.150,00</b>
	<b>Basic price:</b>	<b>52.480,00</b>	<b>65.600,00</b>

#### Seat shell, polyurethane

01 basic dark  
40 chocolate

#### Seat shell, leather Liso

66 nero  
68 chocolate

#### Glides

04 glides for carpet  
09 anti-slip glides

	Article no.	without VAT in SEK*	with VAT in SEK*
<b>Five-seater bench</b>			
<b>418 224 00</b>			
<b>Position 1</b>			
seat polyurethane integral foam	01	<b>9.920,00</b>	<b>12.400,00</b>
seat leather	02	15.280,00	<b>19.100,00</b>
table	03	6.712,00	<b>8.390,00</b>
<b>Position 2</b>			
seat polyurethane integral foam	01	<b>9.920,00</b>	<b>12.400,00</b>
seat leather	02	15.280,00	<b>19.100,00</b>
table	03	6.712,00	<b>8.390,00</b>
<b>Position 3</b>			
seat polyurethane integral foam	01	<b>9.920,00</b>	<b>12.400,00</b>
seat leather	02	15.280,00	<b>19.100,00</b>
table	03	6.712,00	<b>8.390,00</b>
<b>Position 4</b>			
seat polyurethane integral foam	01	<b>9.920,00</b>	<b>12.400,00</b>
seat leather	02	15.280,00	<b>19.100,00</b>
table	03	6.712,00	<b>8.390,00</b>
<b>Position 5</b>			
seat polyurethane integral foam	01	<b>9.920,00</b>	<b>12.400,00</b>
seat leather	02	15.280,00	<b>19.100,00</b>
table	03	6.712,00	<b>8.390,00</b>
<b>Base and support profile</b>			
powder-coated and natural anodised	01	<b>14.080,00</b>	<b>17.600,00</b>
polished/ gloss anodised	02	21.360,00	<b>26.700,00</b>
<b>Armrests</b>			
none	00	0,00	<b>0,00</b>
only outside	01	2.800,00	<b>3.500,00</b>
at all seats	02	8.240,00	<b>10.300,00</b>
<b>Table unit lateral</b>			
none	00	<b>0,00</b>	<b>0,00</b>
left (view from the front)	01	3.720,00	<b>4.650,00</b>
right (view from the front)	02	3.720,00	<b>4.650,00</b>
both sides	03	7.320,00	<b>9.150,00</b>
<b>Basic price:</b>		<b>63.680,00</b>	<b>79.600,00</b>

**Seat shell, polyurethane**

01 basic dark  
40 chocolate

**Seat shell, leather Liso**

66 nero  
68 chocolate

**Glides**

04 glides for carpet  
09 anti-slip glides

## Lounge chairs and armchairs



Amoebe  
Verner Panton  
216



EA 124/125  
Charles & Ray Eames  
217



EA 222/223  
Charles & Ray Eames  
218



ES 106  
Charles & Ray Eames  
219



Citizen Lowback  
Konstantin Grcic  
220



Citizen Highback  
Konstantin Grcic  
221



Cité  
Jean Prouvé  
222



Coconut Chair  
George Nelson  
223



Cone Chair  
Verner Panton  
224



Heart Cone Chair  
Verner Panton  
225



RAR Fiberglass  
Charles & Ray Eames  
226



RAR  
Charles & Ray Eames  
227



East River Chair  
Hella Jongerius  
228



Fauteuil de Salon  
Jean Prouvé  
229



Grand Relax  
Antonio Citterio  
230



HAL Lounge Chair  
Jasper Morrison  
232



Lounge Chair  
Charles & Ray Eames  
234



La Chaise  
Charles & Ray Eames  
242



LCM  
Charles & Ray Eames  
243



LCW  
Charles & Ray Eames  
244



Organic Highback  
Charles Eames &  
Eero Saarinen  
245



Repos  
Antonio Citterio  
246



Grand Repos  
Antonio Citterio  
248



Petit Repos  
Antonio Citterio  
251



Slow Chair  
R & E Bouroullec  
252

## Compatible products in other chapters



Mariposa Club Armchair  
Barber & Osgerby  
309



Suita Club Armchair  
Antonio Citterio  
356



Office and conference chairs (swivel)

Chairs

Tables

Desks

Public waiting areas

Lounge chairs and armchairs

Sofas

Coffee and side tables

Stools and benches

Storage and partition elements

Accessories

Living, dining, decorative objects, home office,  
clocks, lighting, publications

Quick Ship programme

General terms, conditions  
and information



# Amoebe

Verner Panton, 1970

vitra.



**Amoebe**

**Amoebe Highback**

**Backrest:** laminated frame.

**Upholstery:** polyurethane foam.

**Seat height:** 350 mm (215 mm with applied load, measured in accordance with EN 1335-1:2000).

<b>Amoebe</b>	Article no.	without VAT in SEK*	with VAT in SEK*
	<b>210 004 00</b>		
Fabric F60		14.080,00	<b>17.600,00</b>
Fabric F100		16.240,00	<b>20.300,00</b>

<b>Amoebe Highback</b>	Article no.	without VAT in SEK*	with VAT in SEK*
	<b>210 235 00</b>		
Fabric F60		21.600,00	<b>27.000,00</b>
Fabric F100		24.880,00	<b>31.100,00</b>

Fabric F60

Fabric F100

. Velo

. Tonus

# Aluminium Chair EA 124/125

## Charles & Ray Eames, 1958



EA 124



EA 125

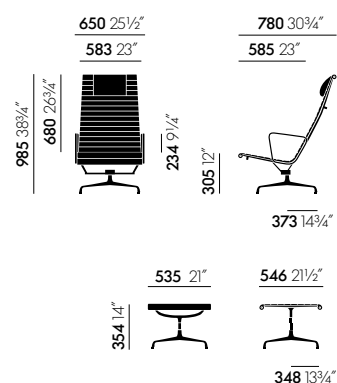

All measurements are pursuant to EN 1335-1:2000  
More detailed information is found in the chapter 'Explanation of measurements'.

### EA 124

**Backrest and seat:** chair with high backrest. High-frequency welded upholstery with horizontal ribbing; cover in fabric or leather. Side profiles and spreaders in die-cast aluminium, with a polished or chrome-plated finish or powder-coated in deep black.

**Seat mechanism:** adjustable backward tilt.

**Armrests:** die-cast aluminium, with a polished or chrome-plated finish or powder-coated in deep black.

**Base:** four-star base in die-cast aluminium, with a polished or chrome-plated finish or powder-coated in deep black.

### EA 125

**Seat:** non-swivel. Upholstered with high-frequency welded ribbing in fabric or leather. Side profiles and spreaders in die-cast aluminium, with a polished or chrome-plated finish or powder-coated in deep black.

**Base:** four-star base in die-cast aluminium, with a polished or chrome-plated finish or powder-coated in deep black.

EA 124	Article no.	without VAT in SEK*	with VAT in SEK*
<b>swivel</b>	<b>412 366 00</b>		
with armrests			
Fabric F60		32.800,00	<b>41.000,00</b>
Leather L20		40.240,00	<b>50.300,00</b>
Leather L50		46.400,00	<b>58.000,00</b>
<b>Surcharges base</b>			
polished	1	0,00	<b>0,00</b>
powder-coated in deep black	4	0,00	<b>0,00</b>
chromed	0	2.920,00	<b>3.650,00</b>

EA 125	Article no.	without VAT in SEK*	with VAT in SEK*
<b>stool</b>	<b>412 367 00</b>		
non-swivel			
Fabric F60		13.520,00	<b>16.900,00</b>
Leather L20		16.400,00	<b>20.500,00</b>
Leather L50		18.080,00	<b>22.600,00</b>
<b>Surcharges base</b>			
polished	1	0,00	<b>0,00</b>
powder-coated in deep black	4	0,00	<b>0,00</b>
chromed	0	864,00	<b>1.080,00</b>

Fabric F60	Leather L20	Leather L50	Glides
· Hopsak	· Leather/back panel Plano	· Leather Premium F/back panel Plano	04 glides for carpet 05 felt glides for hard floor

# Soft Pad Chair EA 222/223

## Charles & Ray Eames, 1969

vitra.



EA 222



EA 223

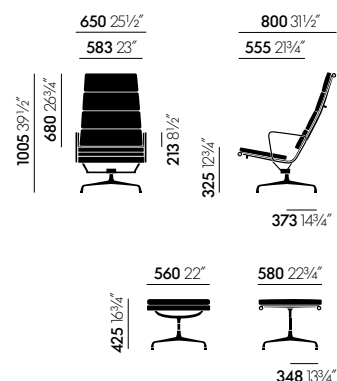

All measurements are pursuant to EN 1335-1:2000  
 More detailed information is found in the chapter 'Explanation of measurements'.

### EA 222

**Backrest and seat:** chair with high backrest. Five sewn-on cushions with polyurethane foam upholstery in leather. Side profiles and spreaders in die-cast aluminium, with a polished or chrome-plated finish or powder-coated in deep black.

**Seat mechanism:** adjustable backward tilt.

**Armrests:** die-cast aluminium, with a polished or chrome-plated finish or powder-coated in deep black.

**Base:** four-star base in die-cast aluminium, with a polished or chrome-plated finish or powder-coated in deep black.

### EA 223

**Seat:** non-swivel. Sewn-on cushion with polyurethane foam upholstery in leather. Side profiles and spreaders in die-cast aluminium, with a polished or chrome-plated finish or powder-coated in deep black.

**Base:** four-star base in die-cast aluminium, with a polished or chrome-plated finish or powder-coated in deep black.

### EA 222

	Article no.	without VAT in SEK*	with VAT in SEK*
<b>swivel</b>	<b>412 383 00</b>		
with armrests			
Leather L20		42.960,00	<b>53.700,00</b>
Leather L50		49.280,00	<b>61.600,00</b>
<b>Surcharges base</b>			
polished	1	0,00	<b>0,00</b>
powder-coated in deep black	4	0,00	<b>0,00</b>
chromed	0	2.920,00	<b>3.650,00</b>

### EA 223

	Article no.	without VAT in SEK*	with VAT in SEK*
<b>Stool</b>	<b>412 384 00</b>		
non-swivel			
Leather L20		17.600,00	<b>22.000,00</b>
Leather L50		20.320,00	<b>25.400,00</b>
<b>Surcharges base</b>			
polished	1	0,00	<b>0,00</b>
powder-coated in deep black	4	0,00	<b>0,00</b>
chromed	0	864,00	<b>1.080,00</b>

#### Leather L20

Leather/back panel Plano

#### Leather L50

Leather Premium F (contrast seam)/back panel Plano

#### Glides

04 glides for carpet  
 05 felt glides for hard floor

# Soft Pad Chaise ES 106

Charles & Ray Eames, 1968

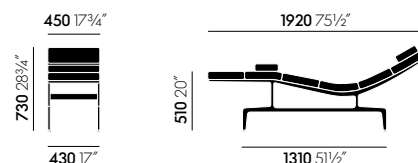

**Upholstery/cover:** padded leather upholstery, six fixed and two loose cushions.

**Base:** die-cast aluminium, powder-coated (smooth).

**Range of use:** recommended for residential use only.

## ES 106

	Article no.	without VAT in SEK*	with VAT in SEK*
	<b>412 034 00</b>		
Leather L20		62.560,00	<b>78.200,00</b>
Leather L50		71.200,00	<b>89.000,00</b>

### Leather L20

Leather/back panel Plano

### Leather L50

Leather Premium F (contrast seam)/back panel Plano

### Glides

04 glides for carpet  
05 felt glides for hard floor

# Citizen

Konstantin Grcic, 2020

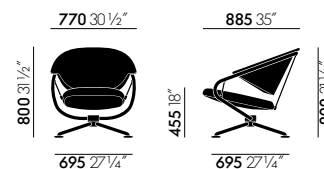

Citizen Lowback

All measurements are pursuant to EN 1335-1:2000  
More detailed information is found in the chapter 'Explanation of measurements'.

**Frame:** tubular steel, powder-coated in deep black (textured finish).

**Back:** support shell in rigid polyurethane foam, encased in moulded polyurethane foam.

**Neck cushion (Citizen Highback):** filled with a mix of 50% polyester fibre and 50% ball fibre.

**Seat:** metal inserts, encased in moulded polyurethane foam. Suspended on frame by means of three steel cables, cathodic dip coating in black.

**Cover:** fabric or leather.

**Seat height:** 455 mm (320 mm with applied load, measured in accordance with EN 1335-1:2000).

**Base:** four-star swivel base made of tubular steel, powder-coated in deep black (textured finish), plastic glides with felt inserts.

Citizen Lowback	Article no.	without VAT in SEK*	with VAT in SEK*
		<b>210 652 00</b>	
Fabric F30		24.560,00	<b>30.700,00</b>
Fabric F40		24.880,00	<b>31.100,00</b>
Fabric F80		26.480,00	<b>33.100,00</b>
Fabric F120		28.000,00	<b>35.000,00</b>
Leather L20		32.560,00	<b>40.700,00</b>
Leather L50		39.440,00	<b>49.300,00</b>

Fabric F30	Fabric F40	Fabric F80	Fabric F120	Leather L20	Leather L50
. Plano	. Laser RE	. Cosy 2	. Credo . Track	. Leather	. Leather Premium F

# Citizen

## Konstantin Grcic, 2020

vitra.

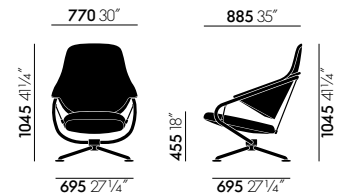

Citizen Highback

All measurements are pursuant to EN 1335-1:2000  
More detailed information is found in the chapter 'Explanation of measurements'.

**Frame:** tubular steel, powder-coated in deep black (textured finish).

**Back:** support shell in rigid polyurethane foam, encased in moulded polyurethane foam.

**Neck cushion (Citizen Highback):** filled with a mix of 50% polyester fibre and 50% ball fibre.

**Seat:** metal inserts, encased in moulded polyurethane foam. Suspended on frame by means of three steel cables, cathodic dip coating in black.

**Cover:** fabric or leather.

**Seat height:** 455 mm (320 mm with applied load, measured in accordance with EN 1335-1:2000).

**Base:** four-star swivel base made of tubular steel, powder-coated in deep black (textured finish), plastic glides with felt inserts.

### Citizen Highback

	Article no.	without VAT in SEK*	with VAT in SEK*
		<b>210 651 00</b>	
Fabric F30		32.080,00	<b>40.100,00</b>
Fabric F40		32.400,00	<b>40.500,00</b>
Fabric F80		34.320,00	<b>42.900,00</b>
Fabric F120		36.160,00	<b>45.200,00</b>
Leather L20		43.760,00	<b>54.700,00</b>
Leather L50		52.000,00	<b>65.000,00</b>
<b>Surcharges neck support cushion</b>			
Fabric F30		1.368,00	<b>1.710,00</b>
Fabric F40		1.432,00	<b>1.790,00</b>
Fabric F80		1.800,00	<b>2.250,00</b>
Fabric F100		1.912,00	<b>2.390,00</b>
Fabric F120		2.120,00	<b>2.650,00</b>
Leather L20		3.192,00	<b>3.990,00</b>
Leather L50		4.200,00	<b>5.250,00</b>

Fabric F30	Fabric F40	Fabric F80	Fabric F100 - for neck cushion	Fabric F120	Leather L20	Leather L50
· Plano	· Laser RE	· Cosy 2	· Aura	· Credo Track	· Leather	· Leather Premium F

# Cité

Jean Prouvé, 1930

vitra.

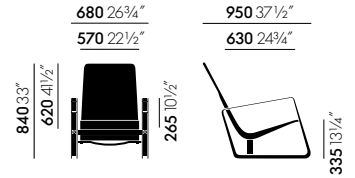

**Cover:** seat and backrest with a continuous cover in fabric or leather.

**Upholstery:** neck cushion in polyurethane foam, height-adjustable.

**Seat height:** 335 mm (210 mm with applied load, measured in accordance with EN 1335-1).

**Base:** bent sheet steel, powder-coated finish (smooth).

**Glides:** fitted with plastic glides for carpet; felt glides for hard floors optionally available.

**Note:** the steel frame in Métal Brut has a raw irregular surface protected by a transparent powder coating.

## Cité

	Article no.	without VAT in SEK*	with VAT in SEK*
	<b>210 437 00</b>		
Fabric F40		31.680,00	<b>39.600,00</b>
Fabric F80		33.440,00	<b>41.800,00</b>
Leather L50		43.360,00	<b>54.200,00</b>
<b>Surcharges base</b>			
Colour group 1		0,00	<b>0,00</b>
Colour group 2		920,00	<b>1.150,00</b>

Fabric F40	Fabric F80	Leather L50
. Mello	. Tress	. Leather Premium F

### Base frame Colour group 1

- 06 Japanese red powder-coated (smooth)
- 12 deep black powder-coated (smooth)
- 88 Prouvé Blanc Colombe (Ecrú) powder-coated (smooth)

### Base frame Colour group 2

- 13 Prouvé Gris Vermeer powder-coated (smooth)
- 14 Prouvé Bleu Dynastie powder-coated (smooth)
- 18 Prouvé Blé Vert powder-coated (smooth)
- 41 Prouvé Bleu Marcoule powder-coated (smooth)
- 94 Prouvé Métal Brut powder-coated (transparent, smooth)

### Glides

- 04 glides for carpet
- 05 felt glides for hard floor



# Coconut Chair

George Nelson, 1955

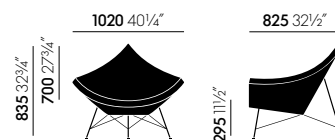

**Shell:** glass fibre reinforced plastic in white.

**Upholstery:** one-piece polyurethane foam padding.

**Seat height:** 295 mm (255 mm with applied load, measured in accordance with EN 1335-1:2000).

**Base:** tubular steel, polished chrome finish.

**Glides:** fitted with plastic glides for carpet; felt glides for hard floors optionally available.

## Coconut Chair

	Article no.	without VAT in SEK*	with VAT in SEK*
		<b>210 459 00</b>	
Fabric F60		35.920,00	<b>44.900,00</b>
Leather L20		50.240,00	<b>62.800,00</b>
Leather L50		56.160,00	<b>70.200,00</b>

### Fabric F60

. Hopsak

### Leather L20

. Leather

### Leather L50

. Leather Premium F

### Glides

04 glides for carpet  
05 felt glides for hard floor

# Cone Chair

Verner Panton, 1958

vitra.

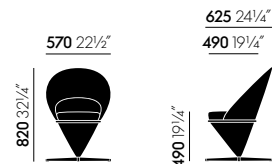
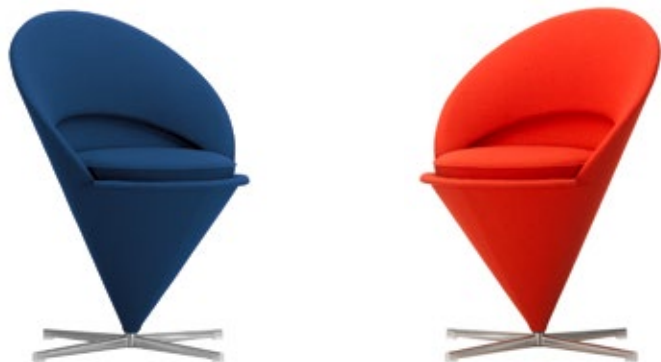

**Body:** GRP (glass fibre reinforced plastic laminate).

**Upholstery:** lightly padded with polyurethane foam. Seat cushion.

**Base:** stainless steel cruciform base, satin finish.

**Glides:** plastic.

## Cone Chair

	Article no.	without VAT in SEK*	with VAT in SEK*
	<b>406 004 00</b>		
Fabric F100		21.280,00	<b>26.600,00</b>

## Fabric F100

Tonus

# Heart Cone Chair

Verner Panton, 1958

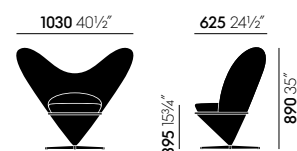

**Body:** GRP (glass fibre reinforced plastic laminate).

**Upholstery:** polyurethane foam.

**Seat height:** 395 mm (applied load 380 mm, measured in accordance with EN 1335-1:2000).

**Base:** stainless steel cruciform base, satin finish.

**Glides:** plastic.

## Heart Cone Chair

	Article no.	without VAT in SEK*	with VAT in SEK*
	<b>406 003 00</b>		
Fabric F100		30.720,00	<b>38.400,00</b>

### Fabric F100

. Tonus

# Eames Fiberglass Chairs

## Charles & Ray Eames, 1950

vitra.

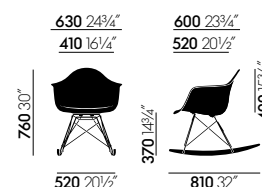

All measurements are pursuant to EN 1335-1:2000  
More detailed information is found in the chapter 'Explanation of measurements'.

**Seat shell:** dyed-through, glass-fibre reinforced polyester (fibreglass). Just like the earliest models, today's fibreglass shells are also slightly transparent in some colours. Optionally available with a moulded foam seat cushion (screwed to the seat shell); cushion can be replaced by the Vitra service team.

### RAR

	Article no.	without VAT in SEK*	with VAT in SEK*
<b>rocking chair</b>	<b>440 455 00</b>		
without upholstery		9.480,00	<b>11.850,00</b>
<b>rocking chair</b>	<b>440 456 00</b>		
with seat upholstery			
Fabric F60		10.432,00	<b>13.040,00</b>
Fabric F200		11.680,00	<b>14.600,00</b>

Fabric F60	Fabric F200	Seat shell (Eames Fiberglass Armchair)	Base RAR	Rocking skids RAR
· Hopsak	· Checker	01 Eames Parchment 04 Eames Elephant Hide Grey 05 Eames Sea Foam Green 06 Eames Raw Umber	01 chrome 04 white powder-coated (smooth) 30 basic dark powder-coated (smooth)	02 golden maple 95 dark maple

# Eames Plastic Armchair RAR

Charles & Ray Eames, 1950

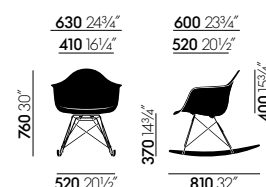

All measurements are pursuant to EN 1335-1:2000  
More detailed information is found in the chapter 'Explanation of measurements'.

**Seat shell:** dyed-through polypropylene. All models are available with a seat cushion (screwed to the seat shell) or full upholstery. The fully upholstered version has moulded polyurethane foam padding covered in fabric, attached to the shell with a welted edge. Different shell and upholstery colours and various bases provide a multitude of possible combinations.

**Options:** the Eames Plastic Chair is available as a visitor chair, dining chair, rocking chair, swivel chair or in stacking versions and with ganging brackets for row seating. Beam-mounted shells are suited for use in waiting areas.

## Eames Plastic Armchair RAR

**RAR base:** wire base with cross struts, chrome-plated or powder-coated, solid maple runners. (RAR = Rocking Armchair Rod Base)

**Origin of wood:** maple (*Acer platanoides*) from Western Europe and/or Poland.

RAR	Article no.	without VAT in SEK*	with VAT in SEK*
<b>rocking chair</b>	<b>440 365 00</b>		
without seat upholstery		5.952,00	<b>7.440,00</b>
<b>rocking chair</b>	<b>440 366 00</b>		
with seat upholstery			
Fabric F60		6.904,00	<b>8.630,00</b>
Fabric F200		8.152,00	<b>10.190,00</b>
<b>rocking chair</b>	<b>440 367 00</b>		
with full upholstery			
Fabric F60		8.768,00	<b>10.960,00</b>

Fabric F60	Fabric F200	Seat shell	Base RAR	Rocking skids RAR
Hopsak	Checker	03 poppy red 04 white 11 pebble 12 deep black 23 ice grey 24 light grey 26 sunlight	34 mustard 41 pale rose 42 green 43 rusty orange 48 forest 56 granite grey 83 sea blue	01 chrome 04 white powder-coated (smooth) 30 basic dark powder-coated (smooth) 02 golden maple 95 dark maple

# East River Chair

Hella Jongerius, 2014

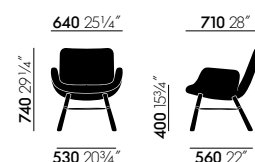

**Seat shell:** laminated.

**Upholstery:** polyurethane foam with fabric and leather cover.

**Cover:** Premium Leather and various fabrics (Laser, Hopsak, Plano) in coordinated colour combinations.

**Seat height:** 400 mm (330 mm with applied load, measured in accordance with EN 1335-1).

**Base:** legs in natural oak with steel cross braces powder-coated in ivory or dark oak legs with braces powder-coated in coffee.

**Glides:** fitted with plastic glides for carpet, felt glides for hard floors additionally included.

**Origin of wood:** oak (Quercus robur) from Western Europe and/or Poland.

## East River Chair

	Article no.	without VAT in SEK*	with VAT in SEK*
	<b>210 441 00</b>		
Fabric mix		22.320,00	<b>27.900,00</b>

**Note:** you will find an overview of the colour and fabric combinations for the different sofa versions in the supplement entitled 'Cover materials'.

### Light mix 01

05 Plano - cream white/sierra grey  
65 Laser RE - ice blue/cream  
71 Leather Premium F - sand  
71 Hopsak - yellow/pastel green

### Red mix 02

63 Hopsak - red/poppy red  
71 Leather Premium F - sand  
74 Laser RE - nude/light red  
96 Plano - red/cognac

### Green mix 04

63 Laser RE - warm grey/cream  
67 Leather Premium F - asphalt  
69 Plano - dark grey  
70 Hopsak - grass green/forest

### Blue mix 05

20 Laser RE - ice blue/moor brown  
66 Plano - nero  
67 Leather Premium F - asphalt  
84 Hopsak - blue/moor brown

### Base

04 dark stained solid oak, with protective varnish  
10 natural oak, with protective varnish

# Fauteuil de Salon

Jean Prouvé, 1939

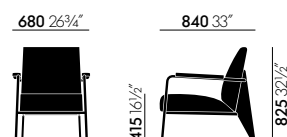

**Seat and backrest:** polyurethane filling; cover in fabric or leather.

**Seat height:** 415 mm (340 mm with applied load, measured in accordance with EN 1335-1:2000).

**Armrests:** solid wood in natural oak with oiled finish, dark stained oak with protective natural lacquer finish, or American walnut with oiled finish.

**Base:** bent sheet steel and tubular steel, powder-coated (smooth).

**Glides:** hard glides for carpet or felt glides for hard floors.

**Origin of wood:** oak (*Quercus robur*) from Western Europe and/or Poland; American walnut (*Juglans nigra*) from the USA.

**Note:** the steel frame in „Métal Brut“ has a raw irregular surface protected by a transparent powder coating.

## Fauteuil de Salon

	Article no.	without VAT in SEK*	with VAT in SEK*
	<b>210 438 00</b>		
Fabric F60		26.080,00	<b>32.600,00</b>
Fabric F80		26.720,00	<b>33.400,00</b>
Fabric F100		27.280,00	<b>34.100,00</b>
Leather L50		36.160,00	<b>45.200,00</b>
<b>Surcharges base</b>			
Colour group 1		0,00	<b>0,00</b>
Colour group 2		920,00	<b>1.150,00</b>

Fabric F60	Fabric F80	Fabric F100	Leather L50	Armrests	Glides
· Twill	· Tress	· Nubia	· Leather Premium F	04 dark stained solid oak, with protective varnish 70 natural solid oak, oiled 75 solid American walnut, oiled	04 glides for carpet 05 felt glides for hard floor

### Base frame Colour group 1

06 Japanese red powder-coated (smooth)  
12 deep black powder-coated (smooth)  
88 Prouvé Blanc Colombe (Ecrú) powder-coated (smooth)

### Base frame Colour group 2

13 Prouvé Gris Vermeer powder-coated (smooth)  
14 Prouvé Bleu Dynastie powder-coated (smooth)  
18 Prouvé Blé Vert powder-coated (smooth)  
41 Prouvé Bleu Marcoule powder-coated (smooth)  
94 Prouvé Métal Brut powder-coated (transparent, smooth)

# Grand Relax

Antonio Citterio, 2019



**Seat/body:** moulded polyurethane foam with plastic frame and integrated synchronised mechanism with locking device.

**Seat heights:** 415 mm (310 mm with applied load, measured in accordance with EN 1335-1:2000) or 465 mm (360 mm with applied load, measured in accordance with EN 1335-1:2000).

**Base:** four-star swivel base in die-cast aluminium, polished or powder-coated finish.

**Seat cushion:** chamber cushion filled with polyurethane foam lozenges and ball fibres.

**Back cushion and neck cushion:** chamber cushion filled with polyurethane foam cubes and a mix of goose feathers and down.

**Note:** Cushions should be regularly shaken and plumped to retain their original fullness and shape.

**Note:** The back shell, the understructure of the seat and ottoman, and the adjustment knob for backrest resistance are covered in Leather Forte (decorative split leather).

**Note:** The base version determines the finish of the other metal parts (mechanism control lever, cap on resistance adjustment knob).

**Note:** total height with headrest in highest position 1080 or 1130 mm.

**Ottoman:** MDF panel covered with polyurethane foam and polyester fleece; chamber cushion filled with polyurethane foam lozenges and ball fibres.

**Base:** non-swivel four-star base in die-cast aluminium, polished or powder-coated finish.

**Glides:** fitted with plastic glides for soft floors or felt glides for hard floors.



# Grand Relax

Antonio Citterio, 2019

**vitra.**

<b>Grand Relax</b>	Article no.	without VAT in SEK*	with VAT in SEK*
	<b>210 590 00</b>		
Fabric F80		49.120,00	<b>61.400,00</b>
Fabric F100		51.120,00	<b>63.900,00</b>
Leather L50		65.360,00	<b>81.700,00</b>

<b>Grand Relax &amp; Ottoman</b>	Article no.	without VAT in SEK*	with VAT in SEK*
	<b>210 592 00</b>		
Fabric F80		65.680,00	<b>82.100,00</b>
Fabric F100		68.320,00	<b>85.400,00</b>
Leather L50		89.200,00	<b>111.500,00</b>

<b>Grand Relax Ottoman</b>	Article no.	without VAT in SEK*	with VAT in SEK*
	<b>210 591 00</b>		
Fabric F80		16.560,00	<b>20.700,00</b>
Fabric F100		17.200,00	<b>21.500,00</b>
Leather L50		23.840,00	<b>29.800,00</b>

<b>Fabric F80</b>	<b>Fabric F100</b>	<b>Leather L50</b>	<b>Leather Forte (deco)</b>
. Corsaro	. Nubia	. Leather Premium F	01 cognac (dark)
. Cosy 2			02 marron (dark)
. Dumet			03 umbra grey
			04 chocolate
			05 nero
			07 sand

<b>Base</b>	<b>Glides</b>	<b>Seat height</b>	<b>Height Ottoman</b>
03 polished aluminium	04 glides for carpet	01 low (415 mm)	01 low (395 mm)
30 basic dark powder-coated (smooth)	05 felt glides for hard floor	02 high (465 mm)	02 high (445 mm)



# HAL Lounge Chair

Jasper Morrison, 2021

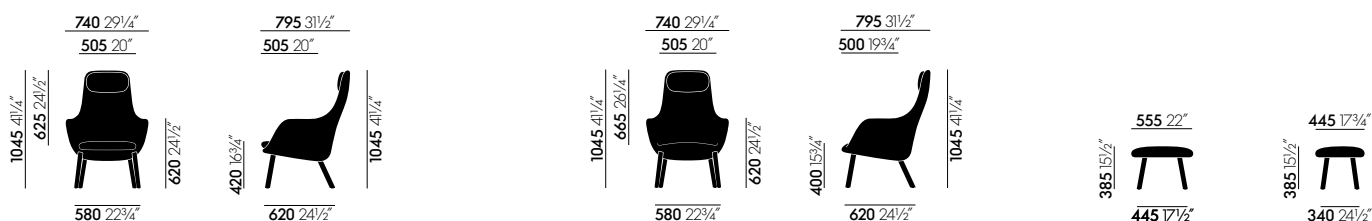

HAL Lounge Chair with loose cushion

HAL Lounge Chair integrated cushion

HAL Lounge Chair Ottoman

All measurements are pursuant to EN 1335-1:2000

More detailed information is found in the chapter 'Explanation of measurements'.

**Chair/body:** fibreglass-reinforced plastic shell made from post-industrial recycled ABS plastic, encased in moulded polyurethane foam.

**Neck cushion filling:** ball fibres and siliconised fibres.

**Filling loose seat cushion:** polyurethane foam.

**Base:** natural oak or dark oak; connection between shell and base made of die-cast aluminium, powder-coated in dim grey.

**Seat heights:** armchair with loose seat cushion 420 mm (320 mm with applied load, measured in accordance with EN 1335-1:2000); armchair with integrated seat cushion 400 mm (320 mm with applied load, measured in accordance with EN 1335-1:2000).

**Ottoman:** plywood panel, polyurethane foam and polyester fibre.

**Base:** natural oak or dark oak, leg connection in fibreglass-reinforced plastic.

**Origin of wood:** oak (*Quercus robur*) from Western Europe and/or Poland.

**Glides:** plastic glides for carpet or felt glides for hard floors.

**Covers:** removable.

# HAL Lounge Chair

Jasper Morrison, 2021

**vitra.**

HAL Lounge Chair	Article no.	without VAT in SEK*	with VAT in SEK*
<b>with integrated seat cushion</b>	<b>440 481 00</b>		
Fabric F40		24.640,00	<b>30.800,00</b>
Fabric F60		26.320,00	<b>32.900,00</b>
Fabric F80		27.840,00	<b>34.800,00</b>
Fabric F100		28.720,00	<b>35.900,00</b>
Fabric F120		30.320,00	<b>37.900,00</b>
Leather L50		40.480,00	<b>50.600,00</b>
<b>with loose seat cushion</b>	<b>440 480 00</b>		
Fabric F40		27.520,00	<b>34.400,00</b>
Fabric F60		29.200,00	<b>36.500,00</b>
Fabric F80		30.960,00	<b>38.700,00</b>
Fabric F100		31.920,00	<b>39.900,00</b>
Fabric F120		33.600,00	<b>42.000,00</b>
Leather L50		43.840,00	<b>54.800,00</b>

HAL Lounge Chair & Ottoman	Article no.	without VAT in SEK*	with VAT in SEK*
<b>with integrated seat cushion</b>	<b>440 483 00</b>		
Fabric F40		33.280,00	<b>41.600,00</b>
Fabric F60		35.200,00	<b>44.000,00</b>
Fabric F80		37.040,00	<b>46.300,00</b>
Fabric F100		38.080,00	<b>47.600,00</b>
Fabric F120		40.480,00	<b>50.600,00</b>
Leather L50		52.960,00	<b>66.200,00</b>
<b>with loose seat cushion</b>	<b>440 482 00</b>		
Fabric F40		36.160,00	<b>45.200,00</b>
Fabric F60		38.080,00	<b>47.600,00</b>
Fabric F80		40.160,00	<b>50.200,00</b>
Fabric F100		41.280,00	<b>51.600,00</b>
Fabric F120		43.760,00	<b>54.700,00</b>
Leather L50		56.320,00	<b>70.400,00</b>

HAL Lounge Ottoman	Article no.	without VAT in SEK*	with VAT in SEK*
	<b>440 484 00</b>		
Fabric F40		8.640,00	<b>10.800,00</b>
Fabric F60		8.880,00	<b>11.100,00</b>
Fabric F80		9.200,00	<b>11.500,00</b>
Fabric F100		9.360,00	<b>11.700,00</b>
Fabric F120		10.160,00	<b>12.700,00</b>
Leather L50		12.480,00	<b>15.600,00</b>

Fabric F40	Fabric F60	Fabric F80	Fabric F100	Fabric F120	Leather L50	Glides	Base
· Laser RE	· Volo	· Cosy 2 · Dumet	· Nubia	· Credo	· Leather Premium F	04 glides for carpet 05 felt glides for hard floor	04 dark stained solid oak, with protective varnish 10 natural oak, with protective varnish

# Lounge Chair

Charles & Ray Eames, 1956

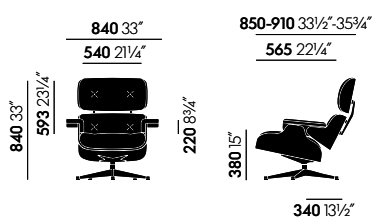

Lounge Chair classic dimensions

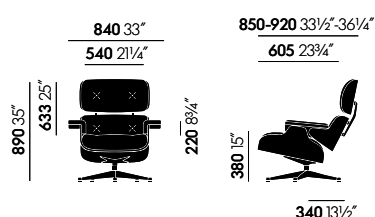

Lounge Chair new dimensions

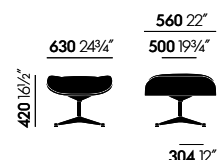

Lounge Chair Ottoman

**Seat and back:** moulded plywood, different face veneers. Classic version in American cherry (USA), santos palisander (Bolivia; certified sustainability) or black-pigmented walnut (USA). White version: white-pigmented walnut (USA). Black version: ash with a black lacquer finish (Germany).

**Upholstery/Cover:** removable cushion units, covers in leather.

**Seat height:** 380 mm (250 mm with applied load, measured in accordance with EN 1335-1:2000).

**Armrests:** upholstered in leather, attached to the seat and back shells with shock mounts (bonded rubber and metal connectors).

**Base:** five-star swivel base or four-star non-swivel base (Ottoman). Both base and back braces in die-cast aluminium.

**Glides:** all bases fitted with hard glides for carpet; felt glides optionally available for hard floors.

# Lounge Chair

Charles & Ray Eames, 1956

Lounge Chair & Ottoman - santos palisander	Article no.	without VAT in SEK*	with VAT in SEK*
		<b>412 122 00</b>	
polished	1	100.648,00	<b>125.810,00</b>
polished / sides black	2	98.568,00	<b>123.210,00</b>
<b>Surcharge Leather</b>			
Leather L50		0,00	<b>0,00</b>
Leather L60		10.864,00	<b>13.580,00</b>

Lounge Chair - santos palisander	Article no.	without VAT in SEK*	with VAT in SEK*
		<b>412 123 00</b>	
polished	1	73.904,00	<b>92.380,00</b>
polished / sides black	2	72.864,00	<b>91.080,00</b>
<b>Surcharge Leather</b>			
Leather L50		0,00	<b>0,00</b>
Leather L60		8.004,00	<b>10.005,00</b>

Ottoman - santos palisander	Article no.	without VAT in SEK*	with VAT in SEK*
		<b>412 124 00</b>	
polished	1	26.744,00	<b>33.430,00</b>
polished / sides black	2	25.704,00	<b>32.130,00</b>
<b>Surcharge leather</b>			
Leather L50		0,00	<b>0,00</b>
Leather L60		2.860,00	<b>3.575,00</b>

**Note:** the choice of colours for the Lounge Chair is coordinated with the veneer and cannot be modified.

#### Leather Premium F (Santos palisander) - L50

66 nero  
68 chocolate  
72 snow  
77 brown  
87 plum  
93 brandy

#### Leather Natural F (Santos palisander) - L60

01 caramel  
66 nero  
68 chocolate  
78 dark sand

#### Glides

04 glides for carpet  
05 felt glides for hard floor

#### Dimensions

01 classic dimensions  
02 new dimensions

# Lounge Chair

Charles & Ray Eames, 1956

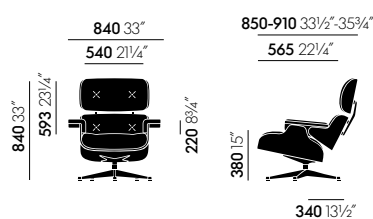

Lounge Chair classic dimensions

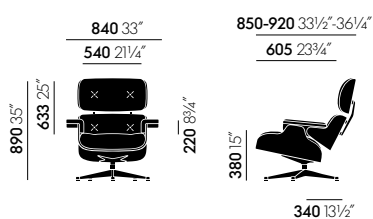

Lounge Chair new dimensions

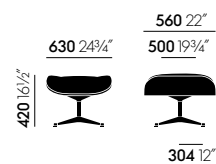

Lounge Chair Ottoman

**Seat and back:** moulded plywood, different face veneers. Classic version in American cherry (USA), santos palisander (Bolivia; certified sustainability) or black-pigmented walnut (USA). White version: white-pigmented walnut (USA). Black version: ash with a black lacquer finish (Germany).

**Upholstery/Cover:** removable cushion units, covers in leather.

**Seat height:** 380 mm (250 mm with applied load, measured in accordance with EN 1335-1:2000).

**Armrests:** upholstered in leather, attached to the seat and back shells with shock mounts (bonded rubber and metal connectors).

**Base:** five-star swivel base or four-star non-swivel base (Ottoman). Both base and back braces in die-cast aluminium.

**Glides:** all bases fitted with hard glides for carpet; felt glides optionally available for hard floors.

# Lounge Chair

Charles & Ray Eames, 1956

Lounge Chair & Ottoman - black-pigmented walnut	Article no.	without VAT in SEK*	with VAT in SEK*
		<b>412 125 00</b>	
polished	1	89.752,00	<b>112.190,00</b>
polished / sides black	2	87.672,00	<b>109.590,00</b>
<b>Surcharge leather</b>			
Leather L50		0,00	<b>0,00</b>
Leather L60		10.864,00	<b>13.580,00</b>

Lounge Chair - black-pigmented walnut	Article no.	without VAT in SEK*	with VAT in SEK*
		<b>412 126 00</b>	
polished	1	66.608,00	<b>83.260,00</b>
polished / sides black	2	65.568,00	<b>81.960,00</b>
<b>Surcharge leather</b>			
Leather L50		0,00	<b>0,00</b>
Leather L60		8.004,00	<b>10.005,00</b>

Ottoman - black-pigmented walnut	Article no.	without VAT in SEK*	with VAT in SEK*
		<b>412 127 00</b>	
polished	1	23.144,00	<b>28.930,00</b>
polished / sides black	2	22.104,00	<b>27.630,00</b>
<b>Surcharge leather</b>			
Leather L50		0,00	<b>0,00</b>
Leather L60		2.860,00	<b>3.575,00</b>

**Note:** the choice of colours for the Lounge Chair is coordinated with the veneer and cannot be modified.

#### Leather Premium F (black-pigmented walnut) - L50

61 umbra grey  
66 nero  
68 chocolate  
69 marron  
72 snow  
77 brown

#### Leather Natural F (black-pigmented walnut) - L60

01 caramel  
66 nero  
68 chocolate  
78 dark sand

#### Glides

04 glides for carpet  
05 felt glides for hard floor

#### Dimensions

01 classic dimensions  
02 new dimensions



# Lounge Chair

Charles & Ray Eames, 1956

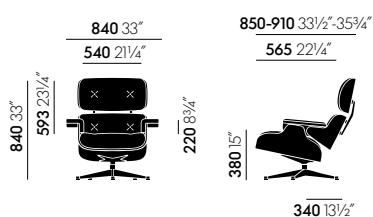

Lounge Chair classic dimensions

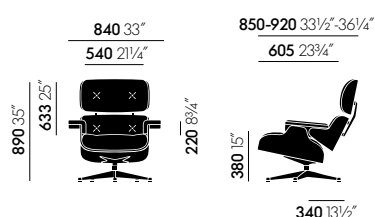

Lounge Chair new dimensions

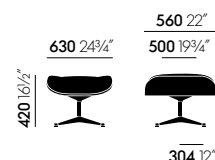

Lounge Chair Ottoman

**Seat and back:** moulded plywood, different face veneers. Classic version in American cherry (USA), santos palisander (Bolivia; certified sustainability) or black-pigmented walnut (USA). White version: white-pigmented walnut (USA). Black version: ash with a black lacquer finish (Germany).

**Upholstery/Cover:** removable cushion units, covers in leather.

**Seat height:** 380 mm (250 mm with applied load, measured in accordance with EN 1335-1:2000).

**Armrests:** upholstered in leather, attached to the seat and back shells with shock mounts (bonded rubber and metal connectors).

**Base:** five-star swivel base or four-star non-swivel base (Ottoman). Both base and back braces in die-cast aluminium.

**Glides:** all bases fitted with hard glides for carpet; felt glides optionally available for hard floors.



# Lounge Chair

Charles & Ray Eames, 1956

Lounge Chair & Ottoman - american cherry	Article no.	without VAT in SEK*	with VAT in SEK*
	<b>412 133 00</b>		
polished	1	81.056,00	<b>101.320,00</b>
polished / sides black	2	78.976,00	<b>98.720,00</b>
<b>Surcharge leather</b>			
Leather L50		0,00	<b>0,00</b>
Leather L60		10.864,00	<b>13.580,00</b>

Lounge Chair - american cherry	Article no.	without VAT in SEK*	with VAT in SEK*
	<b>412 134 00</b>		
polished	1	59.516,00	<b>74.395,00</b>
polished / sides black	2	58.476,00	<b>73.095,00</b>
<b>Surcharge leather</b>			
Leather L50		0,00	<b>0,00</b>
Leather L60		8.004,00	<b>10.005,00</b>

Ottoman - american cherry	Article no.	without VAT in SEK*	with VAT in SEK*
	<b>412 135 00</b>		
polished	1	21.540,00	<b>26.925,00</b>
polished / sides black	2	20.500,00	<b>25.625,00</b>
<b>Surcharge leather</b>			
Leather L50		0,00	<b>0,00</b>
Leather L60		2.860,00	<b>3.575,00</b>

**Note:** the choice of colours for the Lounge Chair is coordinated with the veneer and cannot be modified.

#### Leather Premium F (American cherry) - L50

58 khaki  
61 umbra grey  
66 nero  
68 chocolate  
71 sand  
72 snow  
77 brown

#### Leather Natural F (American cherry) - L60

01 caramel  
66 nero  
68 chocolate  
78 dark sand

#### Glides

04 glides for carpet  
05 felt glides for hard floor

#### Dimensions

01 classic dimensions  
02 new dimensions

# Lounge Chair

Charles & Ray Eames, 1956

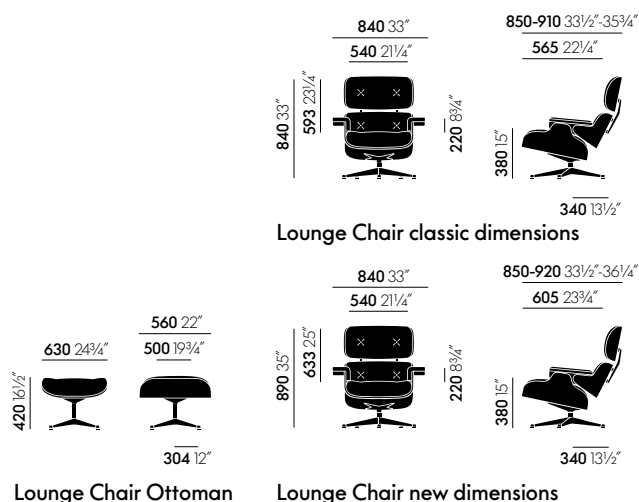

**Seat and back:** moulded plywood, different face veneers. Classic version in American cherry (USA), santos palisander (Bolivia; certified sustainability) or black-pigmented walnut (USA). White version: white-pigmented walnut (USA). Black version: ash with a black lacquer finish (Germany).

**Upholstery/Cover:** removable cushion units, covers in leather.

**Seat height:** 380 mm (250 mm with applied load, measured in accordance with EN 1335-1:2000).

**Armrests:** upholstered in leather, attached to the seat and back shells with shock mounts (bonded rubber and metal connectors).

**Base:** five-star swivel base or four-star non-swivel base (Ottoman). Both base and back braces in die-cast aluminium.

**Glides:** all bases fitted with hard glides for carpet; felt glides optionally available for hard floors.

## Lounge Chair & Ottoman - white-pigmented walnut

	Article no.	without VAT in SEK*	with VAT in SEK*
		<b>412 116 00</b>	
polished	1	89.752,00	<b>112.190,00</b>
<b>Surcharge leather</b>			
Leather L50		0,00	<b>0,00</b>
Leather L60		10.864,00	<b>13.580,00</b>

## Lounge Chair - white-pigmented walnut

	Article no.	without VAT in SEK*	with VAT in SEK*
		<b>412 117 00</b>	
polished	1	66.608,00	<b>83.260,00</b>
<b>Surcharge leather</b>			
Leather L50		0,00	<b>0,00</b>
Leather L60		8.004,00	<b>10.005,00</b>

## Ottoman - white-pigmented walnut

	Article no.	without VAT in SEK*	with VAT in SEK*
		<b>412 118 00</b>	
polished	1	23.144,00	<b>28.930,00</b>
<b>Surcharge leather</b>			
Leather L50		0,00	<b>0,00</b>
Leather L60		2.860,00	<b>3.575,00</b>

**Note:** the choice of colours for the Lounge Chair is coordinated with the veneer and cannot be modified.

Leather Premium F (white-pigmented walnut) - L50

72 snow  
73 clay  
74 olive

Leather Natural F (white-pigmented walnut) - L60

78 dark sand

Glides

04 glides for carpet  
05 felt glides for hard floor

Dimensions

01 classic dimensions  
02 new dimensions

# Lounge Chair

Charles & Ray Eames, 1956

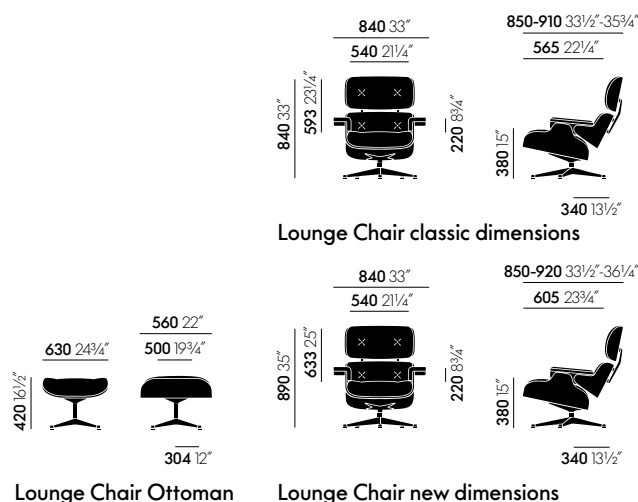

**Seat and back:** moulded plywood, different face veneers. Classic version in American cherry (USA), santos palisander (Bolivia; certified sustainability) or black-pigmented walnut (USA). White version: white-pigmented walnut (USA). Black version: ash with a black lacquer finish (Germany).

**Upholstery/Cover:** removable cushion units, covers in leather.

**Seat height:** 380 mm (250 mm with applied load, measured in accordance with EN 1335-1:2000).

**Armrests:** upholstered in leather, attached to the seat and back shells with shock mounts (bonded rubber and metal connectors).

**Base:** five-star swivel base or four-star non-swivel base (Ottoman). Both base and back braces in die-cast aluminium.

**Glides:** all bases fitted with hard glides for carpet; felt glides optionally available for hard floors.

## Lounge Chair & Ottoman - black ash

	Article no.	without VAT in SEK*	with VAT in SEK*
	<b>412 119 00</b>		
black coated	3	89.752,00	<b>112.190,00</b>
<b>Surcharge leather</b>			
Leather L50		0,00	<b>0,00</b>
Leather L60		10.864,00	<b>13.580,00</b>

## Lounge Chair - black ash

	Article no.	without VAT in SEK*	with VAT in SEK*
	<b>412 120 00</b>		
black coated	3	66.608,00	<b>83.260,00</b>
<b>Surcharge leather</b>			
Leather L50		0,00	<b>0,00</b>
Leather L60		8.004,00	<b>10.005,00</b>

## Ottoman - black ash

	Article no.	without VAT in SEK*	with VAT in SEK*
	<b>412 121 00</b>		
black coated	3	23.144,00	<b>28.930,00</b>
<b>Surcharge leather</b>			
Leather L50		0,00	<b>0,00</b>
Leather L60		2.860,00	<b>3.575,00</b>

**Note:** the choice of colours for the Lounge Chair is coordinated with the veneer and cannot be modified.

Leather Premium F (black ash) - L50	Leather Natural F (black ash) - L60	Glides	Dimensions
66 nero	66 nero	04 glides for carpet	01 classic dimensions
67 asphalt	68 chocolate	05 felt glides for hard floor	02 new dimensions
68 chocolate			



# La Chaise

Charles & Ray Eames, 1948

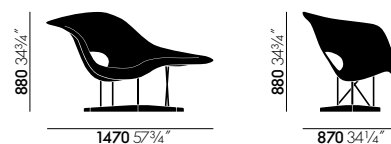

**Shell:** polyester resin, white lacquer finish.

**Base:** chrome-plated tubular steel.

**Cruciform base:** solid natural oak, protective natural lacquer finish.

**Origin of wood:** oak (*Quercus robur*) from Western Europe and/or Poland.

## La Chaise

white shell

Article no.	without VAT in SEK*	with VAT in SEK*
412 100 01	89.040,00	111.300,00

# Plywood Group

## Charles & Ray Eames, 1945/1946

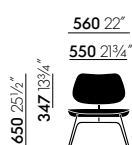

LCM

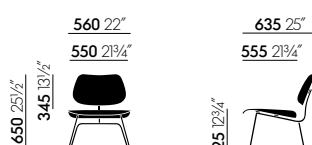

LCM Calf's Skin

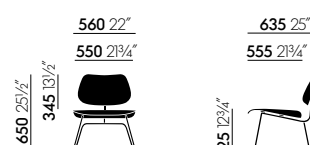

LCM Leather

All measurements are pursuant to EN 1335-1:2000  
More detailed information is found in the chapter 'Explanation of measurements'.

### LCM = Lounge Chair Metal

**Back/seat:** moulded plywood with face veneer in ash or walnut.

**Upholstery:** thin foam padding, covered in leather (LCW Leather) or calfskin hide (LCW Calf's Skin).

**Base:** tubular steel, chrome-plated or powder-coated. Seat and backrest attached to the base with shock mounts (bonded rubber and metal connectors).

### LCM

	Article no.	without VAT in SEK*	with VAT in SEK*
		<b>210 548 00</b>	
natural ash (new)	64	9.600,00	<b>12.000,00</b>
black ash	68	9.600,00	<b>12.000,00</b>
black-pigmented walnut	45	10.480,00	<b>13.100,00</b>

### LCM Calf's Skin

	Article no.	without VAT in SEK*	with VAT in SEK*
		<b>210 549 00</b>	
natural ash (new), hide brown / white	64	21.360,00	<b>26.700,00</b>
black ash, hide black / white	68	21.360,00	<b>26.700,00</b>

### LCM Leather

	Article no.	without VAT in SEK*	with VAT in SEK*
		<b>210 550 00</b>	
natural ash (new), leather nero	64	19.120,00	<b>23.900,00</b>
black ash, leather nero	68	19.120,00	<b>23.900,00</b>
black-pigmented walnut, leather nero	45	20.000,00	<b>25.000,00</b>

#### Base (DCM, LCM)

01 chrome  
30 basic dark powder-coated (smooth)

#### Glides (DCM, LCM)

04 glides for carpet  
05 felt glides for hard floor

# Plywood Group

## Charles & Ray Eames, 1945/1946



LCW



LCW Calf's Skin



LCW Leather

All measurements are pursuant to EN 1335-1:2000  
More detailed information is found in the chapter 'Explanation of measurements'.

### LCW = Lounge Chair Wood

**Back/seat:** moulded plywood with face veneer in ash or walnut.

**Upholstery:** thin foam padding, covered in leather (LCW Leather) or calfskin hide (LCW Calf's Skin).

**Base:** moulded plywood with same face veneer as the back and seat. Seat and backrest attached to the base with shock mounts (bonded rubber and metal connectors).

### LCW

	Article no.	without VAT in SEK*	with VAT in SEK*
			<b>210 551 00</b>
natural ash	64	15.200,00	<b>19.000,00</b>
black ash	68	15.200,00	<b>19.000,00</b>
black-pigmented walnut	45	17.520,00	<b>21.900,00</b>

### LCW Calf's Skin

	Article no.	without VAT in SEK*	with VAT in SEK*
			<b>210 552 00</b>
natural ash (new), hide brown / white	64	27.360,00	<b>34.200,00</b>
black ash, hide black / white	68	27.360,00	<b>34.200,00</b>

### LCW Leather

	Article no.	without VAT in SEK*	with VAT in SEK*
			<b>210 553 00</b>
natural ash (new), leather nero	64	25.120,00	<b>31.400,00</b>
black ash, leather nero	68	25.120,00	<b>31.400,00</b>
black-pigmented walnut, leather nero	45	27.520,00	<b>34.400,00</b>

# Organic Highback

Charles Eames & Eero Saarinen, 1940

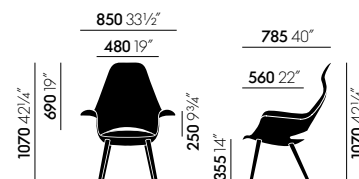

All measurements are pursuant to EN 1335-1:2000  
More detailed information is found in the chapter 'Explanation of measurements'.

**Seat shell:** laminated.

**Upholstery:** polyurethane foam with fabric cover.

**Legs:** black ash or natural oak.

**Glides:** fitted with plastic glides for carpet, felt glides for hard floors additionally included.

**Origin of wood:** oak (*Quercus robur*) and ash (*Fraxinus excelsior*) from Western Europe and/or Poland.

## Organic Highback

	Article no.	without VAT in SEK*	with VAT in SEK*
	<b>210 009 00</b>		
Fabric F60		22.240,00	<b>27.800,00</b>
Fabric F80		23.360,00	<b>29.200,00</b>
Fabric F100		24.240,00	<b>30.300,00</b>
Fabric F120		25.040,00	<b>31.300,00</b>

### Fabric F60

. Hopsak

### Fabric F80

. Cosy 2

### Fabric F100

. Tonus

### Fabric F120

. Credo

### Legs

10 natural oak, with protective varnish  
68 black ash

# Repos

Antonio Citterio, 2011



Repos &amp; Ottoman

Panchina 750

## Repos

**Chair/body:** moulded polyurethane foam with webbed plastic frame and integrated synchronised mechanism with locking device.

**Cover:** fabric or leather, removable.

**Seat heights:** 400 mm (310 mm with applied load, measured in accordance with EN 1335-1:2000) or 450 mm (360 mm with applied load, measured in accordance with EN 1335-1:2000).

**Base:** four-star base in die-cast aluminium, polished or powder-coated finish.

**Note:** the base version determines the finish of the mechanism control lever.

**Neck pillow:** filled with feathers.



# Repos

Antonio Citterio, 2011

vitra.

Repos	Article no.	without VAT in SEK*	with VAT in SEK*
	<b>210 746 00</b>		
Fabric F60		38.800,00	<b>48.500,00</b>
Fabric F80		39.680,00	<b>49.600,00</b>
Fabric F100		41.440,00	<b>51.800,00</b>
Fabric F120		43.840,00	<b>54.800,00</b>
Leather L20		45.600,00	<b>57.000,00</b>
Leather L50		61.440,00	<b>76.800,00</b>
Leather L60		71.920,00	<b>89.900,00</b>

Repos & Ottoman	Article no.	without VAT in SEK*	with VAT in SEK*
	<b>210 747 00</b>		
Fabric F60		53.040,00	<b>66.300,00</b>
Fabric F80		54.400,00	<b>68.000,00</b>
Fabric F100		56.640,00	<b>70.800,00</b>
Fabric F120		60.000,00	<b>75.000,00</b>
Leather L20		62.720,00	<b>78.400,00</b>
Leather L50		85.360,00	<b>106.700,00</b>
Leather L60		99.280,00	<b>124.100,00</b>

Repos & Panchina	Article no.	without VAT in SEK*	with VAT in SEK*
<b>W 750 mm</b>	<b>210 748 00</b>		
Fabric F60		47.760,00	<b>59.700,00</b>
Fabric F80		48.880,00	<b>61.100,00</b>
Fabric F100		50.800,00	<b>63.500,00</b>
Fabric F120		54.320,00	<b>67.900,00</b>
Leather L20		55.840,00	<b>69.800,00</b>
Leather L50		74.800,00	<b>93.500,00</b>
Leather L60		86.480,00	<b>108.100,00</b>

Fabric F60	Fabric F80	Fabric F100	Fabric F120	Leather L20	Leather L50	Leather L60
. Valo . Dumet	. Cosy 2 (cross stitch) . Dumet	. Nubia	. Credo	. Leather (contrast seam)	. Leather Premium F (contrast seam)	. Leather Natural F (contrast seam)

Base	Glides	Seat height	Height Ottoman
03 polished aluminium 30 basic dark powder-coated (smooth)	04 glides for carpet 05 felt glides for hard floor	01 low (400 mm) 02 high (450 mm)	01 low (425 mm) 02 high (475 mm)

# Grand Repos

Antonio Citterio, 2011



Grand Repos &amp; Ottoman

Panchina 750

## Grand Repos

**Chair/body:** moulded polyurethane foam with webbed plastic frame and integrated synchronised mechanism with locking device.

**Cover:** fabric or leather, removable.

**Seat heights:** 400 mm (310 mm with applied load, measured in accordance with EN 1335-1:2000) or 450 mm (360 mm with applied load, measured in accordance with EN 1335-1:2000).

**Base:** four-star base in die-cast aluminium, polished or powder-coated finish.

**Note:** the base version determines the finish of the mechanism control lever.

**Neck pillow:** filled with feathers.

# Grand Repos

Antonio Citterio, 2011

Grand Repos	Article no.	without VAT in SEK*	with VAT in SEK*
	<b>210 749 00</b>		
Fabric F60		42.880,00	<b>53.600,00</b>
Fabric F80		43.840,00	<b>54.800,00</b>
Fabric F100		45.680,00	<b>57.100,00</b>
Fabric F120		48.080,00	<b>60.100,00</b>
Leather L20		50.480,00	<b>63.100,00</b>
Leather L50		67.280,00	<b>84.100,00</b>
Leather L60		79.440,00	<b>99.300,00</b>

Grand Repos & Ottoman	Article no.	without VAT in SEK*	with VAT in SEK*
	<b>210 750 00</b>		
Fabric F60		57.120,00	<b>71.400,00</b>
Fabric F80		58.560,00	<b>73.200,00</b>
Fabric F100		60.880,00	<b>76.100,00</b>
Fabric F120		64.240,00	<b>80.300,00</b>
Leather L20		67.600,00	<b>84.500,00</b>
Leather L50		91.200,00	<b>114.000,00</b>
Leather L60		106.800,00	<b>133.500,00</b>

Grand Repos & Panchina	Article no.	without VAT in SEK*	with VAT in SEK*
<b>W 750 mm</b>	<b>210 751 00</b>		
Fabric F60		51.840,00	<b>64.800,00</b>
Fabric F80		53.040,00	<b>66.300,00</b>
Fabric F100		55.040,00	<b>68.800,00</b>
Fabric F120		58.560,00	<b>73.200,00</b>
Leather L20		60.720,00	<b>75.900,00</b>
Leather L50		80.640,00	<b>100.800,00</b>
Leather L60		94.000,00	<b>117.500,00</b>

Fabric F60	Fabric F80	Fabric F100	Fabric F120	Leather L20	Leather L50	Leather L60
· Valo · Dumet	· Cosy 2 (cross stitch) · Dumet	· Nubia	· Credo	· Leather (contrast seam)	· Leather Premium F (contrast seam)	· Leather Natural F (contrast seam)

Base	Glides	Seat height	Height Ottoman
03 polished aluminium 30 basic dark powder-coated (smooth)	04 glides for carpet 05 felt glides for hard floor	01 low (400 mm) 02 high (450 mm)	01 low (425 mm) 02 high (475 mm)



# Ottoman

Antonio Citterio, 2011

vitra.



Panchina 750



Ottoman

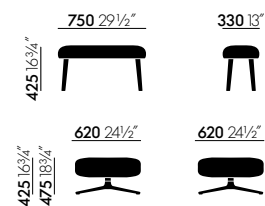

**Panchina:** plywood board, polyurethane foam and polyester fibre.

**Cover:** fabric or leather, removable.

**Legs:** die-cast aluminium, polished or powder-coated finish.

**Glides Panchina:** only available with plastic glides.

**Ottoman:** plastic panel, polyurethane foam and polyester fibre.

**Cover:** fabric or leather, removable.

**Four-star base:** die-cast aluminium, polished or powder-coated finish.

**Glides Ottoman:** fitted with plastic glides for soft floors or felt glides for hard floors.

## Ottoman

	Article no.	without VAT in SEK*	with VAT in SEK*
	<b>210 752 00</b>		
Fabric F60		14.240,00	<b>17.800,00</b>
Fabric F80		14.720,00	<b>18.400,00</b>
Fabric F100		15.200,00	<b>19.000,00</b>
Fabric F120		16.160,00	<b>20.200,00</b>
Leather L20		17.120,00	<b>21.400,00</b>
Leather L50		23.920,00	<b>29.900,00</b>
Leather L60		27.360,00	<b>34.200,00</b>

## Panchina

	Article no.	without VAT in SEK*	with VAT in SEK*
	<b>210 753 00</b>		
Fabric F60		8.960,00	<b>11.200,00</b>
Fabric F80		9.200,00	<b>11.500,00</b>
Fabric F100		9.360,00	<b>11.700,00</b>
Fabric F120		10.480,00	<b>13.100,00</b>
Leather L20		10.240,00	<b>12.800,00</b>
Leather L50		13.360,00	<b>16.700,00</b>
Leather L60		14.560,00	<b>18.200,00</b>

Fabric F60	Fabric F80	Fabric F100	Fabric F120	Leather L20	Leather L50	Leather L60
. Volo . Dumet	. Cosy 2 (cross stitch) . Dumet	. Nubia	. Credo	. Leather (contrast seam)	. Leather Premium F (contrast seam)	. Leather Natural F (contrast seam)

Base	Glides	Seat height	Height Ottoman
03 polished aluminium 30 basic dark powder-coated (smooth)	04 glides for carpet 05 felt glides for hard floor	01 low (400 mm) 02 high (450 mm)	01 low (425 mm) 02 high (475 mm)

# Petit Repos

Antonio Citterio, 2013

vitra.



**Chair/body:** moulded polyurethane foam with plastic frame.

**Seat heights:** 405 mm (330 mm with applied load, measured in accordance with EN 1335-1:2000) or 445 mm (370 mm with applied load, measured in accordance with EN 1335-1:2000).

**Base:** four-star swivel base in die-cast aluminium, polished or powder-coated finish.

## Petit Repos

	Article no.	without VAT in SEK*	with VAT in SEK*
	<b>210 425 00</b>		
Fabric F60		24.160,00	<b>30.200,00</b>
Fabric F80		24.720,00	<b>30.900,00</b>
Fabric F100		25.760,00	<b>32.200,00</b>
Fabric F120		26.720,00	<b>33.400,00</b>
Leather L20		27.920,00	<b>34.900,00</b>
Leather L50		37.680,00	<b>47.100,00</b>
Leather L60		43.760,00	<b>54.700,00</b>

Fabric F60	Fabric F80	Fabric F100	Fabric F120	Leather L20	Leather L50	Leather L60
· Volo	· Cosy 2 (cross stitch) · Dumet	· Nubia	· Credo	· Leather (contrast seam)	· Leather Premium F (contrast seam)	· Leather Natural F (contrast seam)

Base	Glides	Seat height
03 polished aluminium	04 glides for carpet	01 low (400 mm)
30 basic dark powder-coated (smooth)	05 felt glides for hard floor	02 high (450 mm)

# Slow Chair & Ottoman

Ronan & Erwan Bouroullec, 2006



Slow Chair

Ottoman

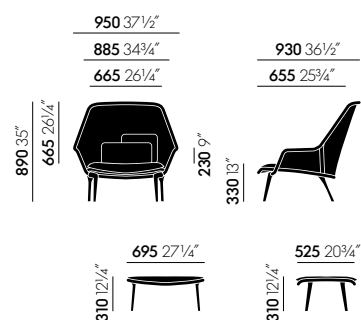

**Frame/Cover:** tubular steel frame with extremely strong, precisely shaped knitted fabric which is stretched over the frame.

**Upholstery:** polyurethane foam and polyester fibre, including a seat cushion and two backrest cushions.

**Seat height:** 330 mm (230 mm with applied load, measured in accordance with EN 1335-1).

**Base:** die-cast aluminium legs with polished or powder-coated finish.

**Glides:** all legs fitted with hard glides for carpet; felt glides optionally available for hard floors.

**Applications:** recommended for home use only.

## Slow Chair

	Article no.	without VAT in SEK*	with VAT in SEK*
	<b>210 223 00</b>		
Base chocolate powder-coated	2	29.280,00	<b>36.600,00</b>
Base polished	1	30.080,00	<b>37.600,00</b>

## Slow Chair Ottoman

	Article no.	without VAT in SEK*	with VAT in SEK*
	<b>210 242 00</b>		
Base chocolate powder-coated	2	12.800,00	<b>16.000,00</b>
Base polished	1	14.240,00	<b>17.800,00</b>

## Slow Chair & Ottoman

	Article no.	without VAT in SEK*	with VAT in SEK*
	<b>210 245 00</b>		
Base chocolate powder-coated	2	42.080,00	<b>52.600,00</b>
Base polished	1	44.320,00	<b>55.400,00</b>

**Note:** you will find an overview of the colour and fabric combinations for the different sofa versions in the appendix entitled 'Cover materials'.

Slow Chair - black	Slow Chair - blue/green	Slow Chair - brown	Slow Chair - brown/cream	Slow Chair - red/cream	Glides
Tricot - black Intreccio - anthracite Tonus - moss-green Laser - black	Tricot - blue/green Twill - ink blue Laser - dark blue/forest Hopsak - nero/forest	Tricot - brown Intreccio - anthracite Tonus - moss-green Aura - blackberry	Tricot - brown/cream Panamone - dark brown Panamone - moss grey Laser - green	Tricot - red/cream Tonus - moss green Coda - cream Laser - green	04 glides for carpet 05 felt glides for hard floor



## Sofas



Abalon Sofa  
R & E Bouroullec  
257



Alcove Sofa  
R & E Bouroullec  
260



Alcove Cabin  
R & E Bouroullec  
272



Alcove Work  
R & E Bouroullec  
279



Alcove Plus Sofa  
R & E Bouroullec  
283



Alcove Plus Work  
R & E Bouroullec  
285



Alcove Plus Desk  
R & E Bouroullec  
288



Alcove Plus Paravent  
R & E Bouroullec  
296



Grand Sofà  
Antonio Citterio  
297



Freeform Sofa  
Isamu Noguchi  
308



Mariposa Sofa  
Barber & Osgerby  
310



Polder  
Hella Jongerius  
313



Soft Modular Sofa  
Jasper Morrison  
315



Suita Sofa Classic  
Antonio Citterio  
324



Suita Sofa pointed cushions  
Antonio Citterio  
333



Suita Sofa tufted  
Antonio Citterio  
344



Suita Daybed  
Antonio Citterio  
351



Suita Club Sofa  
Antonio Citterio  
355



Vlinder Sofa  
Hella Jongerius  
357

---

## Other products in this chapter



Mariposa Club Armchair  
Barber & Osgerby  
309



Suita Club Armchair  
Antonio Citterio  
356



Sofa Tray  
Antonio Citterio  
307

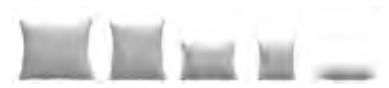

Suita cushions  
Antonio Citterio  
352



Office and conference chairs (swivel)

Chairs

Tables

Desks

Public waiting areas

Lounge chairs and armchairs

Sofas



Coffee and side tables

Stools and benches

Storage and partition elements

Accessories

Living, dining, decorative objects, home office,  
clocks, lighting, publications

Quick Ship programme

General terms, conditions  
and information



# Abalon

Ronan & Erwan Bouroullec, 2022

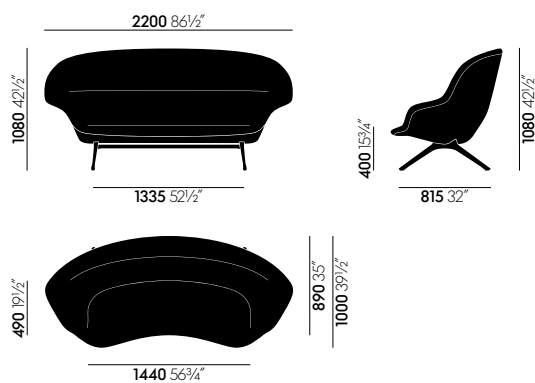

Abalon Sofa

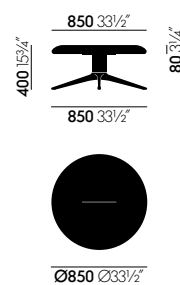

Abalon Platform

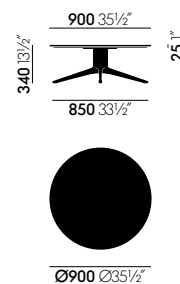

Abalon Table

All measurements are pursuant to EN 1335-1:2000  
 More detailed information is found in the chapter 'Explanation of measurements'.

# Abalon

Ronan & Erwan Bouroullec, 2022

## Abalon Sofa

**Body:** metal frame with moulded polyurethane foam and polyester fleece.

**Seat height:** 400 mm (340 mm with applied load, measured in accordance with EN 1335-1).

**Covers:** knit fabric, removable. Front and back covers are separate and in different colours.

**Legs:** die-cast aluminium, powder-coated.

**Beam:** rectangular tubular steel, powder-coated.

**Glides:** non-slip plastic glides, suitable for soft and hard floors.

## Abalon Platform

**Seat surface:** plywood panel with moulded polyurethane foam and polyester fleece.

**Seat height:** 400 mm (340 mm with applied load, measured in accordance with EN 1335-1).

**Cover:** knit fabric, removable.

**Base:** non-swivel four-star base in die-cast aluminium, powder-coated finish, pedestal in steel, powder-coated finish.

**Glides:** plastic glides for soft floors or felt glides for hard floors.

## Abalon Table

**Table top:** base material MDF (medium-density fibreboard) in real oak veneer or textured powder-coated finish; table thickness 25 mm with 15° bevelled edge.

**Base:** non-swivel four-star base in die-cast aluminium, powder-coated finish, pedestal in steel, powder-coated finish.

**Glides:** plastic glides for soft floors or felt glides for hard floors.

Planum	Drop	Base	Glides (Platform and Table)
01 silver grey (111)	01 dark green/green (961)	12 deep black powder-coated (smooth)	04 glides for carpet
02 dark green (971)	02 dark green/ochre (951)	91 mint powder-coated (smooth)	05 felt glides for hard floor
03 black (1191)	03 dark green/grey (971)		
	04 dark red/red (691)		
	05 dark red/mauve (671)		
	06 light grey/cream (121)		
	07 dark grey/mauve (261)		
	08 mauve/beige (221)		
	09 beige/cream (101)		
	10 black/dark grey (191)		

# Abalon

Ronan & Erwan Bouroullec, 2022

**vitra.**

<b>Abalon Sofa</b>	Article no.	without VAT in SEK*	with VAT in SEK*
	<b>210 740 00</b>		
Front in Drop / back in Planum		58.640,00	<b>73.300,00</b>

<b>Abalon Platform</b>	Article no.	without VAT in SEK*	with VAT in SEK*
	<b>210 742 00</b>		
Drop		15.760,00	<b>19.700,00</b>

<b>Abalon Table</b>	Article no.	without VAT in SEK*	with VAT in SEK*
	<b>210 743 00</b>		
MDF powder-coated in soft light	B1S52	10.720,00	<b>13.400,00</b>
MDF powder-coated in basic dark	B1S30	10.720,00	<b>13.400,00</b>
light oak	C1S17	17.200,00	<b>21.500,00</b>
dark oak	C1S04	17.200,00	<b>21.500,00</b>

<b>Planum</b>	<b>Drop</b>	<b>Base</b>	<b>Glides (Platform and Table)</b>
01 silver grey (111)	01 dark green/green (961)	12 deep black powder-coated (smooth)	04 glides for carpet
02 dark green (971)	02 dark green/ochre (951)	91 mint powder-coated (smooth)	05 felt glides for hard floor
03 black (1191)	03 dark green/grey (971)		
	04 dark red/red (691)		
	05 dark red/mauve (671)		
	06 light grey/cream (121)		
	07 dark grey/mauve (261)		
	08 mauve/beige (221)		
	09 beige/cream (101)		
	10 black/dark grey (191)		



# Alcove Sofa

Ronan & Erwan Bouroullec, 2006/2021

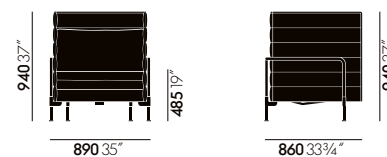

Alcove Fauteuil Lowback (Lounge upholstery)



Alcove Fauteuil Highback (Lounge upholstery)

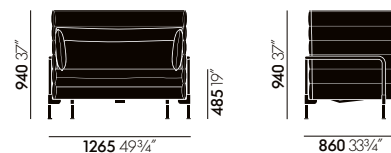

Alcove Love Seat Lowback (Lounge upholstery, with cushion set)

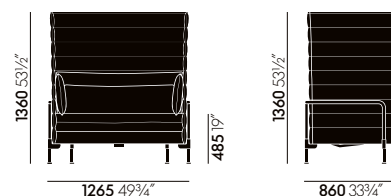

Alcove Love Seat Highback (Work upholstery, with cushion set)

All measurements are pursuant to EN 1335-1:2000  
More detailed information is found in the chapter 'Explanation of measurements'.

# Alcove Sofa

Ronan & Erwan Bouroullec, 2006/2021

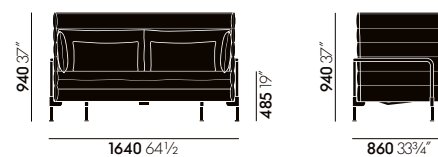

Alcove 2-Seater Lowback (Lounge upholstery, with cushion set)

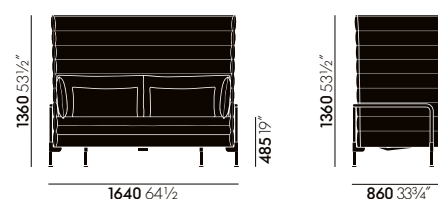

Alcove 2-Seater Highback (Lounge upholstery, with cushion set)

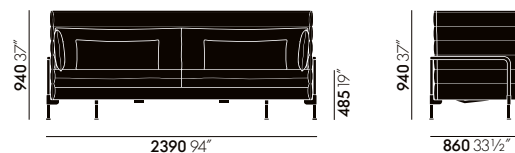

Alcove 3-Seater Lowback (Lounge upholstery, with cushion set)

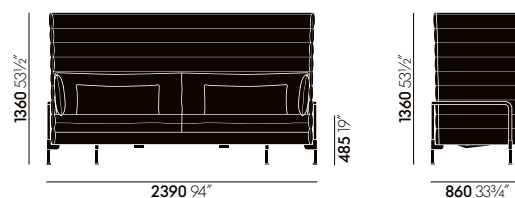

Alcove 3-Seater Highback (Lounge upholstery, with cushion set)

All measurements are pursuant to EN 1335-1:2000  
 More detailed information is found in the chapter 'Explanation of measurements'.

# Alcove Sofa

Ronan & Erwan Bouroullec, 2006/2021

---

**Body:** back and side panels with organic fibreboard core, connected with zip fasteners. Quilted cover with polyester-fibre padding.

**Frame:** tubular steel with chrome-plated finish or powder-coated (smooth).

**Legs:** steel, chrome-plated or powder-coated (smooth). Felt glides. Optionally equipped with lockable castors, in black plastic, soft version for protection of hard floors.

**Upholstery:** Alcove Sofas come in two different upholstery versions: soft ‚Lounge‘ upholstery for relaxed sitting and firmer ‚Work‘ upholstery for work-oriented sitting.

## Lounge Upholstery

**Structural frame:** metal frame with upholstery webbing.

**Seat cushion:** polyurethane foam and polyester fibre.

**Seat height:** 485 mm (325 mm with applied load, measured in accordance with EN 1335-1:2000).

**Back cushions and optional cushion set:** polyurethane chips and microfibre filling.

**Alcove Fauteuil and Love Seat:** incl. 1 back cushion.

**Alcove 2-Seater and 3-Seater:** incl. 2 back cushions.

**Optional cushion set for Love Seat:** 2 armrest cushions (600 x 400 mm) and 1 back cushion (710 x 220 mm).

**Optional cushion set for 2-Seater:** 2 armrest cushions (600 x 400 mm) and 2 back cushions (420 x 220 mm).

**Optional cushion set for 3-Seater:** 2 armrest cushions (600 x 400 mm) and 2 back cushions (710 x 220 mm).

**Covers:** removable.

## Work upholstery

**Structural frame:** metal frame with MDF base board.

**Seat/back cushions:** polyurethane foam and polyester fibre.

**Seat height:** 480 mm (385 mm with applied load, measured in accordance with EN 1335-1:2000).

**Covers:** removable.



# Alcove Sofa

Ronan & Erwan Bouroullec, 2006/2021

**vitra.**

Alcove Fauteuil Lowback		Article no.	without VAT in SEK*	with VAT in SEK*
<b>Work upholstery</b>		<b>210 660 00</b>		
Fabric F40			39.520,00	<b>49.400,00</b>
Fabric F60			42.000,00	<b>52.500,00</b>
Fabric F80			44.720,00	<b>55.900,00</b>
Fabric F120			50.480,00	<b>63.100,00</b>
<b>Surcharges base</b>				
glides		01	0,00	<b>0,00</b>
castors		02	944,00	<b>1.180,00</b>
<b>Surcharges tubular steel frame</b>				
Colour group 1			0,00	<b>0,00</b>
Colour group 2			656,00	<b>820,00</b>
<b>Lounge upholstery</b>		<b>210 661 00</b>		
Fabric F40			43.600,00	<b>54.500,00</b>
Fabric F60			46.400,00	<b>58.000,00</b>
Fabric F80			49.280,00	<b>61.600,00</b>
Fabric F120			55.120,00	<b>68.900,00</b>
<b>Surcharges base</b>				
glides		01	0,00	<b>0,00</b>
castors		02	944,00	<b>1.180,00</b>
<b>Surcharges tubular steel frame</b>				
Colour group 1			0,00	<b>0,00</b>
Colour group 2			656,00	<b>820,00</b>



Fabric F40	Fabric F60	Fabric F80	Fabric F120	Tubular steel frame group 1	Tubular steel frame group 2
. Laser RE	. Volo	. Cosy 2 . Tress	. Credo . Track	01 chrome 12 deep black powder-coated (smooth)	06 Japanese red powder-coated (smooth) 32 dark grey powder-coated (smooth) 52 soft light powder-coated (smooth) 91 mint powder-coated (smooth)

# Alcove Sofa

Ronan & Erwan Bouroullec, 2006/2021

**vitra.**

<b>Alcove Fauteuil Highback</b>		Article no.	without VAT in SEK*	with VAT in SEK*
<b>Work upholstery</b>		<b>210 662 00</b>		
Fabric F40			41.280,00	<b>51.600,00</b>
Fabric F60			43.760,00	<b>54.700,00</b>
Fabric F80			46.640,00	<b>58.300,00</b>
Fabric F120			52.320,00	<b>65.400,00</b>
<b>Surcharges base</b>				
glides		01	0,00	<b>0,00</b>
castors		02	944,00	<b>1.180,00</b>
<b>Surcharges tubular steel frame</b>				
Colour group 1			0,00	<b>0,00</b>
Colour group 2			656,00	<b>820,00</b>
<b>Lounge upholstery</b>		<b>210 663 00</b>		
Fabric F40			46.000,00	<b>57.500,00</b>
Fabric F60			48.560,00	<b>60.700,00</b>
Fabric F80			51.520,00	<b>64.400,00</b>
Fabric F120			57.440,00	<b>71.800,00</b>
<b>Surcharges base</b>				
glides		01	0,00	<b>0,00</b>
castors		02	944,00	<b>1.180,00</b>
<b>Surcharges tubular steel frame</b>				
Colour group 1			0,00	<b>0,00</b>
Colour group 2			656,00	<b>820,00</b>

Fabric F40	Fabric F60	Fabric F80	Fabric F120	Tubular steel frame group 1	Tubular steel frame group 2
. Laser RE	. Volo	. Cosy 2 . Tress	. Credo . Track	01 chrome 12 deep black powder-coated (smooth)	06 Japanese red powder-coated (smooth) 32 dark grey powder-coated (smooth) 52 soft light powder-coated (smooth) 91 mint powder-coated (smooth)

# Alcove Sofa

Ronan & Erwan Bouroullec, 2006/2021

**vitra.**

## Alcove Love Seat Lowback

	Article no.	without VAT in SEK*	with VAT in SEK*
<b>Work upholstery</b>	<b>210 664 00</b>		
Fabric F40		48.480,00	<b>60.600,00</b>
Fabric F60		51.360,00	<b>64.200,00</b>
Fabric F80		54.640,00	<b>68.300,00</b>
Fabric F120		61.520,00	<b>76.900,00</b>
<b>Surcharges base</b>			
glides	01	0,00	<b>0,00</b>
castors	02	944,00	<b>1.180,00</b>
<b>Surcharges tubular steel frame</b>			
Colour group 1		0,00	<b>0,00</b>
Colour group 2		656,00	<b>820,00</b>
<b>Lounge upholstery</b>	<b>210 665 00</b>		
Fabric F40		53.280,00	<b>66.600,00</b>
Fabric F60		56.400,00	<b>70.500,00</b>
Fabric F80		59.680,00	<b>74.600,00</b>
Fabric F120		66.640,00	<b>83.300,00</b>
<b>Surcharges base</b>			
glides	01	0,00	<b>0,00</b>
castors	02	944,00	<b>1.180,00</b>
<b>Surcharges tubular steel frame</b>			
Colour group 1		0,00	<b>0,00</b>
Colour group 2		656,00	<b>820,00</b>



Fabric F40	Fabric F60	Fabric F80	Fabric F120	Tubular steel frame group 1	Tubular steel frame group 2
. Laser RE	. Volo	. Cosy 2 . Tress	. Credo . Track	01 chrome 12 deep black powder-coated (smooth)	06 Japanese red powder-coated (smooth) 32 dark grey powder-coated (smooth) 52 soft light powder-coated (smooth) 91 mint powder-coated (smooth)

# Alcove Sofa

Ronan & Erwan Bouroullec, 2006/2021

**vitra.**

<b>Alcove Love Seat Highback</b>		Article no.	without VAT in SEK*	with VAT in SEK*
<b>Work upholstery</b>		<b>210 666 00</b>		
Fabric F40			58.560,00	<b>73.200,00</b>
Fabric F60			61.440,00	<b>76.800,00</b>
Fabric F80			64.720,00	<b>80.900,00</b>
Fabric F120			71.520,00	<b>89.400,00</b>
<b>Surcharges base</b>				
glides		01	0,00	<b>0,00</b>
castors		02	944,00	<b>1.180,00</b>
<b>Surcharges tubular steel frame</b>				
Colour group 1			0,00	<b>0,00</b>
Colour group 2			656,00	<b>820,00</b>
<b>Lounge upholstery</b>		<b>210 667 00</b>		
Fabric F40			64.720,00	<b>80.900,00</b>
Fabric F60			67.600,00	<b>84.500,00</b>
Fabric F80			71.040,00	<b>88.800,00</b>
Fabric F120			78.080,00	<b>97.600,00</b>
<b>Surcharges base</b>				
glides		01	0,00	<b>0,00</b>
castors		02	944,00	<b>1.180,00</b>
<b>Surcharges tubular steel frame</b>				
Colour group 1			0,00	<b>0,00</b>
Colour group 2			656,00	<b>820,00</b>

Fabric F40	Fabric F60	Fabric F80	Fabric F120	Tubular steel frame group 1	Tubular steel frame group 2
. Laser RE	. Volo	. Cosy 2 . Tress	. Credo . Track	01 chrome 12 deep black powder-coated (smooth)	06 Japanese red powder-coated (smooth) 32 dark grey powder-coated (smooth) 52 soft light powder-coated (smooth) 91 mint powder-coated (smooth)

# Alcove Sofa

Ronan & Erwan Bouroullec, 2006/2021

**vitra.**

<b>Alcove 2-Seater Lowback</b>		Article no.	without VAT in SEK*	with VAT in SEK*
<b>Work upholstery</b>		<b>210 669 00</b>		
Fabric F40			60.000,00	<b>75.000,00</b>
Fabric F60			63.520,00	<b>79.400,00</b>
Fabric F80			67.360,00	<b>84.200,00</b>
Fabric F120			75.360,00	<b>94.200,00</b>
<b>Surcharges base</b>				
glides		01	0,00	<b>0,00</b>
castors		02	944,00	<b>1.180,00</b>
<b>Surcharges tubular steel frame</b>				
Colour group 1			0,00	<b>0,00</b>
Colour group 2			656,00	<b>820,00</b>
<b>Lounge upholstery</b>		<b>210 670 00</b>		
Fabric F40			67.200,00	<b>84.000,00</b>
Fabric F60			70.800,00	<b>88.500,00</b>
Fabric F80			74.560,00	<b>93.200,00</b>
Fabric F120			83.040,00	<b>103.800,00</b>
<b>Surcharges base</b>				
glides		01	0,00	<b>0,00</b>
castors		02	944,00	<b>1.180,00</b>
<b>Surcharges tubular steel frame</b>				
Colour group 1			0,00	<b>0,00</b>
Colour group 2			656,00	<b>820,00</b>



Fabric F40	Fabric F60	Fabric F80	Fabric F120	Tubular steel frame group 1	Tubular steel frame group 2
. Laser RE	. Volo	. Cosy 2 . Tress	. Credo . Track	01 chrome 12 deep black powder-coated (smooth)	06 Japanese red powder-coated (smooth) 32 dark grey powder-coated (smooth) 52 soft light powder-coated (smooth) 91 mint powder-coated (smooth)

# Alcove Sofa

Ronan & Erwan Bouroullec, 2006/2021

**vitra.**

<b>Alcove 2-Seater Highback</b>	Article no.	without VAT in SEK*	with VAT in SEK*
<b>Work upholstery</b>	<b>210 671 00</b>		
Fabric F40		69.600,00	<b>87.000,00</b>
Fabric F60		73.120,00	<b>91.400,00</b>
Fabric F80		76.960,00	<b>96.200,00</b>
Fabric F120		84.880,00	<b>106.100,00</b>
<b>Surcharges base</b>			
glides	01	0,00	<b>0,00</b>
castors	02	944,00	<b>1.180,00</b>
<b>Surcharges tubular steel frame</b>			
Colour group 1		0,00	<b>0,00</b>
Colour group 2		656,00	<b>820,00</b>
<b>Lounge upholstery</b>	<b>210 672 00</b>		
Fabric F40		77.280,00	<b>96.600,00</b>
Fabric F60		80.720,00	<b>100.900,00</b>
Fabric F80		84.800,00	<b>106.000,00</b>
Fabric F120		92.960,00	<b>116.200,00</b>
<b>Surcharges base</b>			
glides	01	0,00	<b>0,00</b>
castors	02	944,00	<b>1.180,00</b>
<b>Surcharges tubular steel frame</b>			
Colour group 1		0,00	<b>0,00</b>
Colour group 2		656,00	<b>820,00</b>

Fabric F40	Fabric F60	Fabric F80	Fabric F120	Tubular steel frame group 1	Tubular steel frame group 2
. Laser RE	. Volo	. Cosy 2 . Tress	. Credo . Track	01 chrome 12 deep black powder-coated (smooth)	06 Japanese red powder-coated (smooth) 32 dark grey powder-coated (smooth) 52 soft light powder-coated (smooth) 91 mint powder-coated (smooth)

# Alcove Sofa

Ronan & Erwan Bouroullec, 2006/2021

**vitra.**

<b>Alcove 3-Seater Lowback</b>		Article no.	without VAT in SEK*	with VAT in SEK*
<b>Work upholstery</b>		<b>210 674 00</b>		
Fabric F40			72.240,00	<b>90.300,00</b>
Fabric F60			76.800,00	<b>96.000,00</b>
Fabric F80			81.840,00	<b>102.300,00</b>
Fabric F120			92.240,00	<b>115.300,00</b>
<b>Surcharges base</b>				
glides		01	0,00	<b>0,00</b>
castors		02	944,00	<b>1.180,00</b>
<b>Surcharges tubular steel frame</b>				
Colour group 1			0,00	<b>0,00</b>
Colour group 2			656,00	<b>820,00</b>
<b>Lounge upholstery</b>		<b>210 675 00</b>		
Fabric F40			80.400,00	<b>100.500,00</b>
Fabric F60			85.040,00	<b>106.300,00</b>
Fabric F80			90.160,00	<b>112.700,00</b>
Fabric F120			100.800,00	<b>126.000,00</b>
<b>Surcharges base</b>				
glides		01	0,00	<b>0,00</b>
castors		02	944,00	<b>1.180,00</b>
<b>Surcharges tubular steel frame</b>				
Colour group 1			0,00	<b>0,00</b>
Colour group 2			656,00	<b>820,00</b>



Fabric F40	Fabric F60	Fabric F80	Fabric F120	Tubular steel frame group 1	Tubular steel frame group 2
. Laser RE	. Volo	. Cosy 2 . Tress	. Credo . Track	01 chrome 12 deep black powder-coated (smooth)	06 Japanese red powder-coated (smooth) 32 dark grey powder-coated (smooth) 52 soft light powder-coated (smooth) 91 mint powder-coated (smooth)

# Alcove Sofa

Ronan & Erwan Bouroullec, 2006/2021

**vitra.**

## Alcove 3-Seater Highback

	Article no.	without VAT in SEK*	with VAT in SEK*
<b>Work upholstery</b>	<b>210 676 00</b>		
Fabric F40		87.680,00	<b>109.600,00</b>
Fabric F60		92.160,00	<b>115.200,00</b>
Fabric F80		97.120,00	<b>121.400,00</b>
Fabric F120		107.360,00	<b>134.200,00</b>
<b>Surcharges base</b>			
glides	01	0,00	<b>0,00</b>
castors	02	944,00	<b>1.180,00</b>
<b>Surcharges tubular steel frame</b>			
Colour group 1		0,00	<b>0,00</b>
Colour group 2		656,00	<b>820,00</b>
<b>Lounge upholstery</b>	<b>210 677 00</b>		
Fabric F40		97.360,00	<b>121.700,00</b>
Fabric F60		102.000,00	<b>127.500,00</b>
Fabric F80		107.120,00	<b>133.900,00</b>
Fabric F120		118.000,00	<b>147.500,00</b>
<b>Surcharges base</b>			
glides	01	0,00	<b>0,00</b>
castors	02	944,00	<b>1.180,00</b>
<b>Surcharges tubular steel frame</b>			
Colour group 1		0,00	<b>0,00</b>
Colour group 2		656,00	<b>820,00</b>

Fabric F40	Fabric F60	Fabric F80	Fabric F120	Tubular steel frame group 1	Tubular steel frame group 2
. Laser RE	. Volo	. Cosy 2 . Tress	. Credo . Track	01 chrome 12 deep black powder-coated (smooth)	06 Japanese red powder-coated (smooth) 32 dark grey powder-coated (smooth) 52 soft light powder-coated (smooth) 91 mint powder-coated (smooth)



# Alcove Sofa

Ronan & Erwan Bouroullec, 2006/2021

**vitra.**

## Cushion set for Love Seat

	Article no.	without VAT in SEK*	with VAT in SEK*
		<b>210 668 00</b>	
Fabric F40		6.280,00	<b>7.850,00</b>
Fabric F60		6.792,00	<b>8.490,00</b>
Fabric F80		7.280,00	<b>9.100,00</b>
Fabric F120		8.560,00	<b>10.700,00</b>

## Cushion set for 2-Seater

	Article no.	without VAT in SEK*	with VAT in SEK*
		<b>210 673 00</b>	
Fabric F40		7.720,00	<b>9.650,00</b>
Fabric F60		8.320,00	<b>10.400,00</b>
Fabric F80		8.960,00	<b>11.200,00</b>
Fabric F120		10.320,00	<b>12.900,00</b>

## Cushion set for 3-Seater

	Article no.	without VAT in SEK*	with VAT in SEK*
		<b>210 678 00</b>	
Fabric F40		7.800,00	<b>9.750,00</b>
Fabric F60		8.560,00	<b>10.700,00</b>
Fabric F80		9.440,00	<b>11.800,00</b>
Fabric F120		11.120,00	<b>13.900,00</b>

Fabric F40	Fabric F60	Fabric F80	Fabric F120	Tubular steel frame group 1	Tubular steel frame group 2
. Laser RE	. Volo	. Cosy 2 . Tress	. Credo . Track	01 chrome 12 deep black powder-coated (smooth)	06 Japanese red powder-coated (smooth) 32 dark grey powder-coated (smooth) 52 soft light powder-coated (smooth) 91 mint powder-coated (smooth)

# Alcove Cabin

Ronan & Erwan Bouroullec, 2012/2021

vitra.



Alcove Cabin Love Seat Lowback

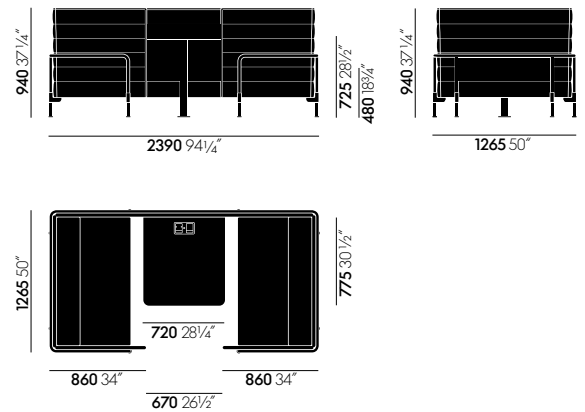

Alcove Cabin Love Seat Highback

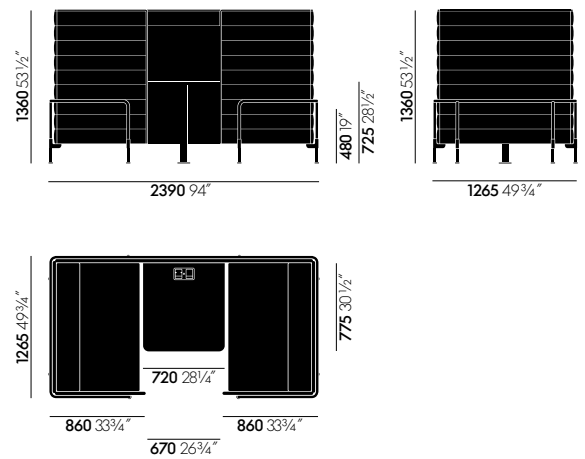

Alcove Cabin 2-Seater Lowback

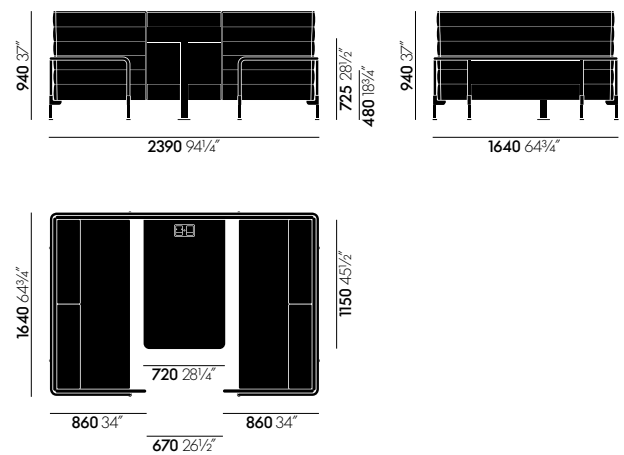

# Alcove Cabin

Ronan & Erwan Bouroullec, 2012/2021

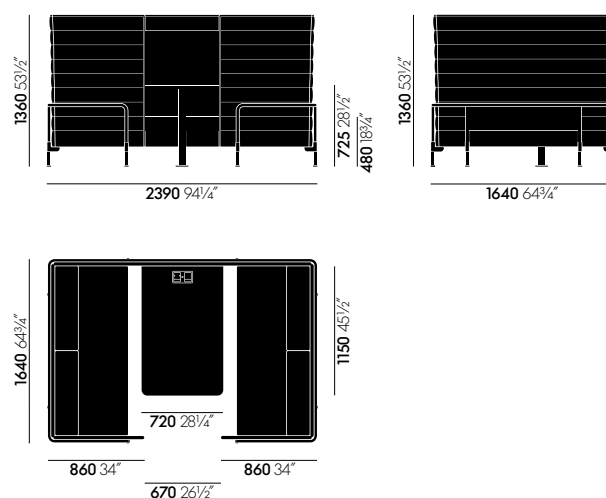

## Alcove Cabin 2-Seater Highback

All measurements are pursuant to EN 1335-1:2000  
More detailed information is found in the chapter 'Explanation of measurements'.

**Structural frame:** tubular steel with chrome-plated finish or powder-coated (smooth), metal frame with MDF base board.

**Body:** back and side panels with organic fibreboard core, connecting panel with organic fibreboard core and metal structure, connected with zip fasteners. Quilted cover with polyester-fibre padding.

**Seat/back cushions:** polyurethane foam and polyester fibre.

**Seat height:** 480 mm (385 mm with applied load, measured in accordance with EN 1335-1:2000).

**Covers:** removable.

**Add-on table:** thickness 25 mm, high-density three-ply fine particle board with melamine coating and 3-mm ABS edge; or MDF board, powder-coated (textured finish); or oak veneer (sourced in Europe) with straight veneered edge 2.5-3.0 mm. Table legs in tubular steel, chrome-plated or powder-coated (smooth). Additional reinforcement in the connecting panel for secure attachment of the table top to the body.

**Table height:** 725 mm.

**Legs:** tubular steel, chrome-plated or powder-coated (smooth). Felt glides. Optionally equipped with lockable castors, in black plastic, soft version for protection of hard floors (only for units without add-on table).

# Alcove Cabin

Ronan & Erwan Bouroullec, 2012/2021

**vitra.**

<b>Alcove Cabin Love Seat Lowback</b>	Article no.	without VAT in SEK*	with VAT in SEK*
<b>Lowback</b>	<b>210 679 00</b>		
Fabric F40		104.640,00	<b>130.800,00</b>
Fabric F60		110.960,00	<b>138.700,00</b>
Fabric F80		118.240,00	<b>147.800,00</b>
Fabric F120		132.960,00	<b>166.200,00</b>
<b>Surcharges base</b>			
glides	01	0,00	<b>0,00</b>
castors (only without add-on table)	02	1.992,00	<b>2.490,00</b>
<b>Surcharges tubular steel frame</b>			
Colour group 1		0,00	<b>0,00</b>
Colour group 2		1.408,00	<b>1.760,00</b>
<b>Surcharges add-on table top 775 x 720 mm</b>			
not included	00000	0,00	<b>0,00</b>
melamine soft light	A1S52	7.560,00	<b>9.450,00</b>
MDF powder-coated in soft light	B1S52	9.280,00	<b>11.600,00</b>
MDF powder-coated in basic dark	B1S30	9.280,00	<b>11.600,00</b>
light oak	C1S17	13.440,00	<b>16.800,00</b>
black oak	C1S50	13.440,00	<b>16.800,00</b>
<b>Surcharges table top electrification</b>			
not included	00	0,00	<b>0,00</b>
Port 180, frame and cover in soft light	5252	3.112,00	<b>3.890,00</b>
Port 180, frame and cover in basic dark	3030	3.112,00	<b>3.890,00</b>
Port 180, frame polished / cover in basic dark	0330	3.400,00	<b>4.250,00</b>
<b>Surcharges equipment for Port 180</b>			
not included	00	0,00	<b>0,00</b>
1x power	01	1.880,00	<b>2.350,00</b>
2x power	02	3.600,00	<b>4.500,00</b>
1x power + 1x USB charger A-C	13	5.920,00	<b>7.400,00</b>
1x power + 1x USB charger C	16	5.640,00	<b>7.050,00</b>

Fabric F40	Fabric F60	Fabric F80	Fabric F120	Tubular steel frame group 1	Tubular steel frame group 2
. Laser RE	. Volo	. Cosy 2 . Tress	. Credo . Track	01 chrome 12 deep black powder-coated (smooth)	06 Japanese red powder-coated (smooth) 32 dark grey powder-coated (smooth) 52 soft light powder-coated (smooth) 91 mint powder-coated (smooth)

# Alcove Cabin

Ronan & Erwan Bouroullec, 2012/2021

vitra.

## Alcove Cabin Love Seat Highback

	Article no.	without VAT in SEK*	with VAT in SEK*
<b>Highback</b>	<b>210 680 00</b>		
Fabric F40		119.280,00	<b>149.100,00</b>
Fabric F60		125.760,00	<b>157.200,00</b>
Fabric F80		132.880,00	<b>166.100,00</b>
Fabric F120		147.760,00	<b>184.700,00</b>
<b>Surcharges base</b>			
glides	01	0,00	<b>0,00</b>
castors (only without add-on table)	02	1.992,00	<b>2.490,00</b>
<b>Surcharges tubular steel frame</b>			
Colour group 1		0,00	<b>0,00</b>
Colour group 2		1.408,00	<b>1.760,00</b>
<b>Surcharges add-on table top 775 x 720 mm</b>			
not included	00000	0,00	<b>0,00</b>
melamine soft light	A1S52	7.560,00	<b>9.450,00</b>
MDF powder-coated in soft light	B1S52	9.280,00	<b>11.600,00</b>
MDF powder-coated in basic dark	B1S30	9.280,00	<b>11.600,00</b>
light oak	C1S17	13.440,00	<b>16.800,00</b>
black oak	C1S50	13.440,00	<b>16.800,00</b>
<b>Surcharges table top electrification</b>			
not included	00	0,00	<b>0,00</b>
Port 180, frame and cover in soft light	5252	3.112,00	<b>3.890,00</b>
Port 180, frame and cover in basic dark	3030	3.112,00	<b>3.890,00</b>
Port 180, frame polished / cover in basic dark	0330	3.400,00	<b>4.250,00</b>
<b>Surcharges equipment for Port 180</b>			
not included	00	0,00	<b>0,00</b>
1x power	01	1.880,00	<b>2.350,00</b>
2x power	02	3.600,00	<b>4.500,00</b>
1x power + 1x USB charger A-C	13	5.920,00	<b>7.400,00</b>
1x power + 1x USB charger C	16	5.640,00	<b>7.050,00</b>
<b>Surcharges screen integration on panel**</b>			
without screen integration	00	0,00	<b>0,00</b>
reinforced panel including VESA mounting***	01	5.272,00	<b>6.590,00</b>

\*\* only possible with Port 180 with "1x Power"

\*\*\* Mount according to VESA standard up to 200 x 200.

Maximum screen size 37 inches, maximum weight 18 kg.

Fabric F40	Fabric F60	Fabric F80	Fabric F120	Tubular steel frame group 1	Tubular steel frame group 2
. Laser RE	. Volo	. Cosy 2 . Tress	. Credo . Track	01 chrome 12 deep black powder-coated (smooth)	06 Japanese red powder-coated (smooth) 32 dark grey powder-coated (smooth) 52 soft light powder-coated (smooth) 91 mint powder-coated (smooth)

# Alcove Cabin

Ronan & Erwan Bouroullec, 2012/2021

**vitra.**

<b>Alcove Cabin 2-Seater Lowback</b>	Article no.	without VAT in SEK*	with VAT in SEK*
<b>Lowback</b>	<b>210 681 00</b>		
Fabric F40		123.120,00	<b>153.900,00</b>
Fabric F60		130.400,00	<b>163.000,00</b>
Fabric F80		138.480,00	<b>173.100,00</b>
Fabric F120		155.200,00	<b>194.000,00</b>
<b>Surcharges base</b>			
glides	01	0,00	<b>0,00</b>
castors (only without add-on table)	02	1.992,00	<b>2.490,00</b>
<b>Surcharges tubular steel frame</b>			
Colour group 1		0,00	<b>0,00</b>
Colour group 2		1.408,00	<b>1.760,00</b>
<b>Surcharges add-on table top 1150x720 mm</b>			
not included	00000	0,00	<b>0,00</b>
melamine soft light	A1S52	8.080,00	<b>10.100,00</b>
MDF powder-coated in soft light	B1S52	10.000,00	<b>12.500,00</b>
MDF powder-coated in basic dark	B1S30	10.000,00	<b>12.500,00</b>
light oak	C1S17	14.400,00	<b>18.000,00</b>
black oak	C1S50	14.400,00	<b>18.000,00</b>
<b>Surcharges table top electrification</b>			
not included	00000	0,00	<b>0,00</b>
Port 180, frame and cover in soft light	5252	3.112,00	<b>3.890,00</b>
Port 180, frame and cover in basic dark	3030	3.112,00	<b>3.890,00</b>
Port 180, frame polished / cover in basic dark	0330	3.400,00	<b>4.250,00</b>
<b>Surcharges equipment for Port 180</b>			
not included	00	0,00	<b>0,00</b>
1x power	01	1.880,00	<b>2.350,00</b>
2x power	02	3.600,00	<b>4.500,00</b>
1x power + 1x USB charger A-C	13	5.920,00	<b>7.400,00</b>
1x power + 1x USB charger C	16	5.640,00	<b>7.050,00</b>

Fabric F40	Fabric F60	Fabric F80	Fabric F120	Tubular steel frame group 1	Tubular steel frame group 2
. Laser RE	. Volo	. Cosy 2 . Tress	. Credo . Track	01 chrome 12 deep black powder-coated (smooth)	06 Japanese red powder-coated (smooth) 32 dark grey powder-coated (smooth) 52 soft light powder-coated (smooth) 91 mint powder-coated (smooth)

# Alcove Cabin

Ronan & Erwan Bouroullec, 2012/2021

vitra.

## Alcove Cabin 2-Seater Highback

	Article no.	without VAT in SEK*	with VAT in SEK*
<b>Highback</b>	<b>210 682 00</b>		
Fabric F40		141.200,00	<b>176.500,00</b>
Fabric F60		148.560,00	<b>185.700,00</b>
Fabric F80		156.640,00	<b>195.800,00</b>
Fabric F120		173.360,00	<b>216.700,00</b>
<b>Surcharges base</b>			
glides	01	0,00	<b>0,00</b>
castors (only without add-on table)	02	1.992,00	<b>2.490,00</b>
<b>Surcharges tubular steel frame</b>			
Colour group 1		0,00	<b>0,00</b>
Colour group 2		1.408,00	<b>1.760,00</b>
<b>Surcharges add-on table top 1150 x 720 mm</b>			
not included	00000	0,00	<b>0,00</b>
melamine soft light	A1S52	8.080,00	<b>10.100,00</b>
MDF powder-coated in soft light	B1S52	10.000,00	<b>12.500,00</b>
MDF powder-coated in basic dark	B1S30	10.000,00	<b>12.500,00</b>
light oak	C1S17	14.400,00	<b>18.000,00</b>
black oak	C1S50	14.400,00	<b>18.000,00</b>
<b>Surcharges table top electrification</b>			
not included	00000	0,00	<b>0,00</b>
Port 180, frame and cover in soft light	5252	3.112,00	<b>3.890,00</b>
Port 180, frame and cover in basic dark	3030	3.112,00	<b>3.890,00</b>
Port 180, frame polished / cover in basic dark	0330	3.400,00	<b>4.250,00</b>
<b>Surcharges equipment for Port 180</b>			
not included	00	0,00	<b>0,00</b>
1x power	01	1.880,00	<b>2.350,00</b>
2x power	02	3.600,00	<b>4.500,00</b>
1x power + 1x USB charger A-C	13	5.920,00	<b>7.400,00</b>
1x power + 1x USB charger C	16	5.640,00	<b>7.050,00</b>
<b>Surcharges screen integration on panel**</b>			
without screen integration	00	0,00	<b>0,00</b>
reinforced panel including VESA mounting***	01	5.272,00	<b>6.590,00</b>

\*\* only possible with Port 180 with "1x Power"

\*\*\* Mount according to VESA standard up to 200 x 200.

Maximum screen size 37 inches, maximum weight 18 kg.

Fabric F40	Fabric F60	Fabric F80	Fabric F120	Tubular steel frame group 1	Tubular steel frame group 2
. Laser RE	. Volo	. Cosy 2 . Tress	. Credo . Track	01 chrome 12 deep black powder-coated (smooth)	06 Japanese red powder-coated (smooth) 32 dark grey powder-coated (smooth) 52 soft light powder-coated (smooth) 91 mint powder-coated (smooth)

# Alcove Cabin

Ronan & Erwan Bouroullec, 2012/2021

**vitra.**

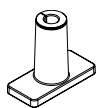

For attaching table lamps to port cable outlet; inner diameter: 10 mm; including reduction sleeve and assembly materials, excl. lamp.

## Lamp adapter for port

	Article no.	without VAT in SEK*	with VAT in SEK*
aluminium powder-coated in soft light	<b>853 466 11</b>	752,00	<b>940,00</b>
polished aluminium	<b>853 466 12</b>	856,00	<b>1.070,00</b>



Including 4 zip fasteners

## Cable net long

		Article no.	without VAT in SEK*	with VAT in SEK*
<b>W 30 x L 1500 mm</b>	polyester basic dark	<b>833 040 02</b>	560,00	<b>700,00</b>
<b>W 30 x L 1500 mm</b>	polyester grey	<b>833 040 12</b>	560,00	<b>700,00</b>



# Alcove Work

Ronan & Erwan Bouroullec, 2010/2021



Alcove Work Lowback

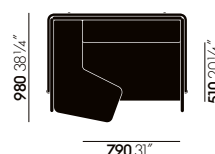

Alcove Work Lowback, tablet desk on left



Alcove Work Highback

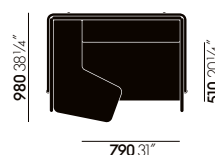

Alcove Work Highback, tablet desk on left

All measurements are pursuant to EN 1335-1:2000  
More detailed information is found in the chapter 'Explanation of measurements'.

**Structural frame:** tubular steel with chrome-plated finish or powder-coated (smooth), metal frame with MDF base board.

**Body:** back and side panels with organic fibreboard core, connected with zip fasteners. Quilted cover with polyester-fibre padding.

**Seat/back cushions:** polyurethane foam and polyester fibre.

**Seat height:** 480 mm (385 mm with applied load, measured in accordance with EN 1335-1:2000).

**Box:** wooden carcass covered in polyurethane foam.

**Tablet desk:** thickness 25 mm, high-density three-ply fine particle board with melamine coating and 3-mm ABS edge; or MDF board, powder-coated (textured finish); or in oak veneer (sourced in Europe) with straight veneered edge 2.5-3.0 mm.

**Covers:** removable.

**Legs:** steel, chrome-plated or powder-coated (smooth). Felt glides. Optionally equipped with lockable castors, in black plastic, soft version for protection of hard floors (only for units without electrification).

# Alcove Work

Ronan & Erwan Bouroullec, 2010/2021

**vitra.**

<b>Alcove Work Lowback</b>	Article no.	without VAT in SEK*	with VAT in SEK*
<b>Lowback</b>	<b>210 683 00</b>		
Fabric F40		56.000,00	<b>70.000,00</b>
Fabric F60		58.960,00	<b>73.700,00</b>
Fabric F80		62.240,00	<b>77.800,00</b>
Fabric F120		69.360,00	<b>86.700,00</b>
<b>Surcharges base</b>			
glides	01	0,00	<b>0,00</b>
castors	02	944,00	<b>1.180,00</b>
<b>Surcharges tubular steel frame</b>			
Colour group 1		0,00	<b>0,00</b>
Colour group 2		656,00	<b>820,00</b>
<b>Surcharges tray</b>			
melamine soft light	A1S52	0,00	<b>0,00</b>
MDF powder-coated in soft light	B1S52	2.552,00	<b>3.190,00</b>
MDF powder-coated basic dark	B1S30	2.552,00	<b>3.190,00</b>
light oak	C1S17	5.080,00	<b>6.350,00</b>
black oak	C1S50	5.080,00	<b>6.350,00</b>
<b>Surcharges tray electrification</b>			
not included	00	0,00	<b>0,00</b>
Punto wireless charging (including USB cable and power supply)	01	5.400,00	<b>6.750,00</b>
Port 120, frame and cover in soft light	5252	1.760,00	<b>2.200,00</b>
Port 120, frame and cover in basic dark	3030	1.760,00	<b>2.200,00</b>
Port 120, frame polished / cover in basic dark	0330	2.072,00	<b>2.590,00</b>
<b>Surcharges equipment for Port 120</b>			
not included	00	0,00	<b>0,00</b>
1x power	01	1.880,00	<b>2.350,00</b>
1x USB charger A-C	12	4.680,00	<b>5.850,00</b>
1x USB charger C	15	4.400,00	<b>5.500,00</b>

Fabric F40	Fabric F60	Fabric F80	Fabric F120
. Laser RE	. Volo	. Cosy 2 . Tress	. Credo . Track

Tubular steel frame group 1	Tubular steel frame group 2	Placement of box
01 chrome	06 Japanese red powder-coated (smooth)	01/R Armrest right/sitting left
12 deep black powder-coated (smooth)	32 dark grey powder-coated (smooth)	02/L Armrest left/sitting right
	52 soft light powder-coated (smooth)	
	91 mint powder-coated (smooth)	

# Alcove Work

Ronan & Erwan Bouroullec, 2010/2021

**vitra.**

## Alcove Work Highback

	Article no.	without VAT in SEK*	with VAT in SEK*
<b>Highback</b>	<b>210 684 00</b>		
Fabric F40		63.920,00	<b>79.900,00</b>
Fabric F60		66.960,00	<b>83.700,00</b>
Fabric F80		70.320,00	<b>87.900,00</b>
Fabric F120		77.280,00	<b>96.600,00</b>
<b>Surcharges base</b>			
glides	01	0,00	<b>0,00</b>
castors	02	944,00	<b>1.180,00</b>
<b>Surcharges tubular steel frame</b>			
Colour group 1		0,00	<b>0,00</b>
Colour group 2		656,00	<b>820,00</b>
<b>Surcharges tray</b>			
melamine soft light	A1S52	0,00	<b>0,00</b>
MDF powder-coated in soft light	B1S52	2.552,00	<b>3.190,00</b>
MDF powder-coated basic dark	B1S30	2.552,00	<b>3.190,00</b>
light oak	C1S17	5.080,00	<b>6.350,00</b>
black oak	C1S50	5.080,00	<b>6.350,00</b>
<b>Surcharges tray electrification</b>			
not included	00	0,00	<b>0,00</b>
Punto wireless charging (including USB cable and power supply)	01	5.400,00	<b>6.750,00</b>
Port 120, frame and cover in soft light	5252	1.760,00	<b>2.200,00</b>
Port 120, frame and cover in basic dark	3030	1.760,00	<b>2.200,00</b>
Port 120, frame polished / cover in basic dark	0330	2.072,00	<b>2.590,00</b>
<b>Surcharges equipment for Port 120</b>			
not included	00	0,00	<b>0,00</b>
1x power	01	1.880,00	<b>2.350,00</b>
1x USB charger A-C	12	4.680,00	<b>5.850,00</b>
1x USB charger C	15	4.400,00	<b>5.500,00</b>

Fabric F40	Fabric F60	Fabric F80	Fabric F120
. Laser RE	. Volo	. Cosy 2 . Tress	. Credo . Track

Tubular steel frame group 1	Tubular steel frame group 2	Placement of box
01 chrome	06 Japanese red powder-coated (smooth)	01/R Armrest right/sitting left
12 deep black powder-coated (smooth)	32 dark grey powder-coated (smooth)	02/L Armrest left/sitting right
	52 soft light powder-coated (smooth)	
	91 mint powder-coated (smooth)	

# Alcove Work

Ronan & Erwan Bouroullec, 2010/2021

**vitra.**

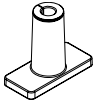

For attaching table lamps to port cable outlet; inner diameter: 10 mm; including reduction sleeve and assembly materials, excl. lamp.

## Lamp adapter for port

	Article no.	without VAT in SEK*	with VAT in SEK*
aluminium powder-coated in soft light	<b>853 466 11</b>	752,00	<b>940,00</b>
polished aluminium	<b>853 466 12</b>	856,00	<b>1.070,00</b>



Including 4 zip fasteners

## Cable net long

		Article no.	without VAT in SEK*	with VAT in SEK*
<b>W 30 x L 1500 mm</b>	polyester basic dark	<b>833 040 02</b>	560,00	<b>700,00</b>
<b>W 30 x L 1500 mm</b>	polyester grey	<b>833 040 12</b>	560,00	<b>700,00</b>

# Alcove Plus Sofa

Ronan & Erwan Bouroullec, 2021

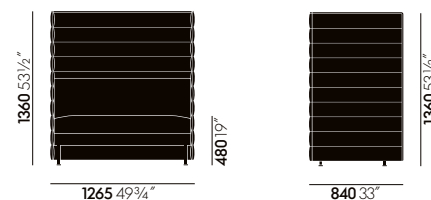

Alcove Plus Love Seat

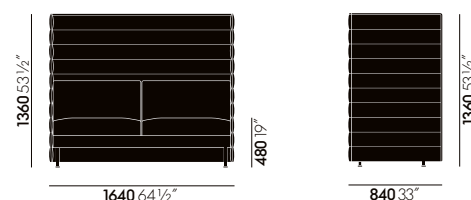

Alcove Plus 2-Seater

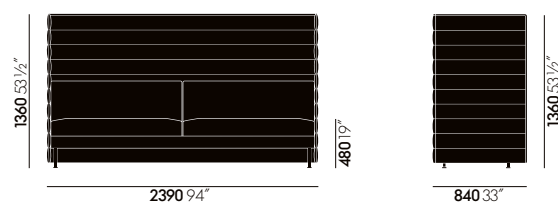

Alcove Plus 3-Seater

All measurements are pursuant to EN 1335-1:2000  
More detailed information is found in the chapter 'Explanation of measurements'.

**Structural frame:** metal frame with MDF base board.

**Body:** back and side panels with organic fibreboard core, connected with zip fasteners. Quilted cover with polyester-fibre padding. A zip fastener along the front edge of the side panels allows for attachment to the optional Alcove Plus Paravent.

**Seat/back cushions:** polyurethane foam and polyester fibre.

**Seat height:** 480 mm (385 mm with applied load, measured in accordance with EN 1335-1:2000).

**Covers:** removable.

**Legs:** steel, chrome-plated or powder-coated (smooth). Felt glides.

# Alcove Plus Sofa

Ronan & Erwan Bouroullec, 2021

**vitra.**

<b>Alcove Plus Love Seat</b>	Article no.	without VAT in SEK*	with VAT in SEK*
	<b>210 685 00</b>		
Fabric F40		58.560,00	<b>73.200,00</b>
Fabric F60		61.920,00	<b>77.400,00</b>
Fabric F80		65.840,00	<b>82.300,00</b>
Fabric F120		73.760,00	<b>92.200,00</b>
<b>Surcharge Base</b>			
Colour group 1		0,00	<b>0,00</b>
Colour group 2		376,00	<b>470,00</b>

<b>Alcove Plus 2-Seater</b>	Article no.	without VAT in SEK*	with VAT in SEK*
	<b>210 686 00</b>		
Fabric F40		69.600,00	<b>87.000,00</b>
Fabric F60		73.760,00	<b>92.200,00</b>
Fabric F80		78.320,00	<b>97.900,00</b>
Fabric F120		87.840,00	<b>109.800,00</b>
<b>Surcharge Base</b>			
Colour group 1		0,00	<b>0,00</b>
Colour group 2		376,00	<b>470,00</b>

<b>Alcove Plus 3-Seater</b>	Article no.	without VAT in SEK*	with VAT in SEK*
	<b>210 687 00</b>		
Fabric F40		87.680,00	<b>109.600,00</b>
Fabric F60		93.040,00	<b>116.300,00</b>
Fabric F80		99.200,00	<b>124.000,00</b>
Fabric F120		111.840,00	<b>139.800,00</b>
<b>Surcharge Base</b>			
Colour group 1		0,00	<b>0,00</b>
Colour group 2		376,00	<b>470,00</b>

Fabric F40	Fabric F60	Fabric F80	Fabric F120	Legs group 1	Legs group 2
. Laser RE	. Volo	. Cosy 2 . Tress	. Credo . Track	01 chrome 12 deep black powder-coated (smooth)	06 Japanese red powder-coated (smooth) 32 dark grey powder-coated (smooth) 52 soft light powder-coated (smooth) 91 mint powder-coated (smooth)

# Alcove Plus Work

Ronan & Erwan Bouroullec, 2021

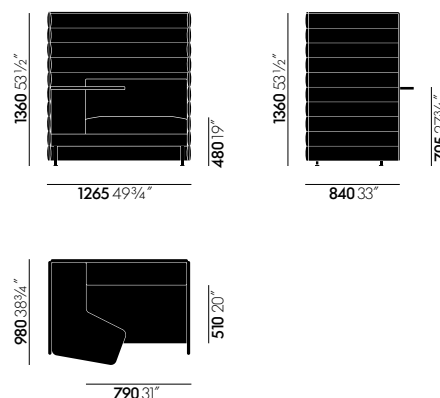

Alcove Plus Work

Alcove Plus Work, tablet desk left

All measurements are pursuant to EN 1335-1:2000  
More detailed information is found in the chapter 'Explanation of measurements'.

**Structural frame:** metal frame with MDF base board.

**Body:** back and side panels with organic fibreboard core, connected with zip fasteners. Quilted cover with polyester-fibre padding. A zip fastener along the front edge of the side panels allows for attachment to the optional Alcove Plus Paravent.

**Seat/back cushions:** polyurethane foam and polyester fibre.

**Seat height:** 480 mm (385 mm with applied load, measured in accordance with EN 1335-1:2000).

**Box:** wooden carcass covered in polyurethane foam.

**Tablet desk:** thickness 25 mm, high-density three-ply fine particle board with melamine coating and 3-mm ABS edge; or MDF board, powder-coated (textured finish); or in oak veneer (sourced in Europe) with straight veneered edge 2.5-3.0 mm.

**Covers:** removable.

**Legs:** steel, chrome-plated or powder-coated (smooth). Felt glides.

# Alcove Plus Work

Ronan & Erwan Bouroullec, 2021

**vitra.**

Alcove Plus Work	Article no.	without VAT in SEK*	with VAT in SEK*
		<b>210 688 00</b>	
Fabric F40		63.920,00	<b>79.900,00</b>
Fabric F60		67.280,00	<b>84.100,00</b>
Fabric F80		71.120,00	<b>88.900,00</b>
Fabric F120		79.200,00	<b>99.000,00</b>
<b>Surcharge legs</b>			
Colour group 1		0,00	<b>0,00</b>
Colour group 2		376,00	<b>470,00</b>
<b>Surcharges tray</b>			
melamine soft light	A1S52	0,00	<b>0,00</b>
MDF powder-coated in soft light	B1S52	2.552,00	<b>3.190,00</b>
MDF powder-coated basic dark	B1S30	2.552,00	<b>3.190,00</b>
light oak	C1S17	5.080,00	<b>6.350,00</b>
black oak	C1S50	5.080,00	<b>6.350,00</b>
<b>Surcharges tray electrification</b>			
not included	00	0,00	<b>0,00</b>
Punto wireless charging (including USB cable and power supply)	01	5.400,00	<b>6.750,00</b>
Port 120, frame and cover in soft light	5252	1.760,00	<b>2.200,00</b>
Port 120, frame and cover in basic dark	3030	1.760,00	<b>2.200,00</b>
Port 120, frame polished / cover in basic dark	0330	2.072,00	<b>2.590,00</b>
<b>Surcharges equipment for Port 120</b>			
not included	00	0,00	<b>0,00</b>
1x power	01	1.880,00	<b>2.350,00</b>
1x USB charger A-C	12	4.680,00	<b>5.850,00</b>
1x USB charger C	15	4.400,00	<b>5.500,00</b>

Fabric F40	Fabric F60	Fabric F80	Fabric F120
. Laser RE	. Volo	. Cosy 2 . Tress	. Credo . Track

Legs group 1	Legs group 2	Placement of box
01 chrome	06 Japanese red powder-coated (smooth)	01/R Armrest right/sitting left
12 deep black powder-coated (smooth)	32 dark grey powder-coated (smooth)	02/L Armrest left/sitting right
	52 soft light powder-coated (smooth)	
	91 mint powder-coated (smooth)	



# Alcove Plus Work

Ronan & Erwan Bouroullec, 2021

vitra.

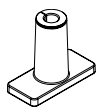

For attaching table lamps to port cable outlet; inner diameter: 10 mm; including reduction sleeve and assembly materials, excl. lamp.

## Lamp adapter for port

	Article no.	without VAT in SEK*	with VAT in SEK*
aluminium powder-coated in soft light	<b>853 466 11</b>	752,00	<b>940,00</b>
polished aluminium	<b>853 466 12</b>	856,00	<b>1.070,00</b>



Including 4 zip fasteners

## Cable net long

		Article no.	without VAT in SEK*	with VAT in SEK*
<b>W 30 x L 1500 mm</b>	polyester basic dark	<b>833 040 02</b>	560,00	<b>700,00</b>
<b>W 30 x L 1500 mm</b>	polyester grey	<b>833 040 12</b>	560,00	<b>700,00</b>



# Alcove Plus Desk

Ronan & Erwan Bouroullec, 2021

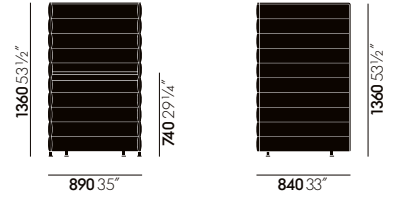

Alcove Plus Desk Small

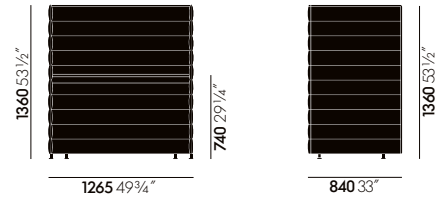

Alcove Plus Desk Medium

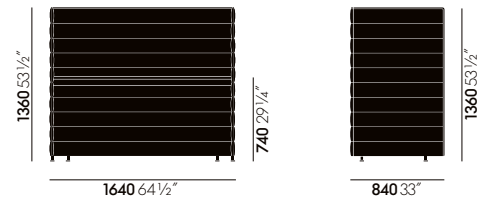

Alcove Plus Desk Large

All measurements are pursuant to EN 1335-1:2000  
More detailed information is found in the chapter 'Explanation of measurements'.

# Alcove Plus Desk

Ronan & Erwan Bouroullec, 2021

---

**Body/structure:** back and side panels with organic fibreboard core and metal frame, connected with zip fasteners. Quilted covers with polyester-fibre padding. A zip fastener along the front edge of the side panels allows for attachment to the optional Alcove Plus Paravent. Metal frame for stabilisation of back and side panels and for support of table top.

**Covers:** removable.

**Table top:** thickness 25 mm, high-density three-ply fine particle board with melamine coating and 3-mm ABS edge; or MDF board, powder-coated (textured finish); or in oak veneer (sourced in Europe) with straight veneered edge 2.5-3.0 mm.

**Table height:** 740 mm.

**Cable basket:** steel wire, powder-coated in black, W 444 x D 114 x H 164 mm. Maximum number of baskets for large desk: 3 units; medium desk: 2 units; and small desk: 1 unit.

**Legs:** tubular steel, chrome-plated or powder-coated (smooth). Non-slip glides, levelling adjustment +/- 10mm.

**Electrification:** When 'table-top electrification' is selected, please configure the suitable Port 120 or 180 as required and order separately along with the feed cable, cable conduit, under-table electrification, distribution block etc. At least one Alcove Plus Desk cable basket is required per Port. The simplest electrification version does not require a Port; cables can be installed on the surface of the table between the table top and panel. The minimum requirement is one cable basket, one power outlet strip and one feed cable. These must also be ordered separately.



# Alcove Plus Desk

Ronan & Erwan Bouroullec, 2021

vitra.

Alcove Plus Desk Small	Article no.	without VAT in SEK*	with VAT in SEK*
	<b>210 689 00</b>		
Fabric F40		45.040,00	<b>56.300,00</b>
Fabric F60		47.360,00	<b>59.200,00</b>
Fabric F80		49.920,00	<b>62.400,00</b>
Fabric F120		55.360,00	<b>69.200,00</b>
<b>Surcharge Base</b>			
Colour group 1		0,00	<b>0,00</b>
Colour group 2		376,00	<b>470,00</b>
<b>Surcharges table top 745 x 700 mm</b>			
melamine soft light	A1S52	0,00	<b>0,00</b>
MDF powder-coated in soft light	B1S52	2.472,00	<b>3.090,00</b>
MDF powder-coated basic dark	B1S30	2.472,00	<b>3.090,00</b>
light oak	C1S17	4.952,00	<b>6.190,00</b>
black oak	C1S50	4.952,00	<b>6.190,00</b>
<b>Surcharges table top electrification</b>			
not provided	00	0,00	<b>0,00</b>
cut-out for Port 120 on right	01	464,00	<b>580,00</b>
cut-out for Port 120 on left	02	464,00	<b>580,00</b>

Alcove Plus Desk Medium	Article no.	without VAT in SEK*	with VAT in SEK*
	<b>210 690 00</b>		
Fabric F40		50.400,00	<b>63.000,00</b>
Fabric F60		52.880,00	<b>66.100,00</b>
Fabric F80		55.680,00	<b>69.600,00</b>
Fabric F120		61.680,00	<b>77.100,00</b>
<b>Surcharge Base</b>			
Colour group 1		0,00	<b>0,00</b>
Colour group 2		376,00	<b>470,00</b>
<b>Surcharges table top 1120 x 700 mm</b>			
melamine soft light	A1S52	0,00	<b>0,00</b>
MDF powder-coated in soft light	B1S52	3.032,00	<b>3.790,00</b>
MDF powder-coated basic dark	B1S30	3.032,00	<b>3.790,00</b>
light oak	C1S17	6.072,00	<b>7.590,00</b>
black oak	C1S50	6.072,00	<b>7.590,00</b>
<b>Surcharges table top electrification</b>			
not provided	00	0,00	<b>0,00</b>
cut-out for Port 180 on right	01	464,00	<b>580,00</b>
cut-out for Port 180 on left	02	464,00	<b>580,00</b>

Fabric F40	Fabric F60	Fabric F80	Fabric F120	Legs group 1	Legs group 2
. Laser RE	. Volo	. Cosy 2 . Tress	. Credo . Track	01 chrome 12 deep black powder-coated (smooth)	06 Japanese red powder-coated (smooth) 32 dark grey powder-coated (smooth) 52 soft light powder-coated (smooth) 91 mint powder-coated (smooth)

# Alcove Plus Desk

Ronan & Erwan Bouroullec, 2021

**vitra.**

<b>Alcove Plus Desk Large</b>	Article no.	without VAT in SEK*	with VAT in SEK*
	<b>210 691 00</b>		
Fabric F40		54.880,00	<b>68.600,00</b>
Fabric F60		57.760,00	<b>72.200,00</b>
Fabric F80		61.120,00	<b>76.400,00</b>
Fabric F120		67.920,00	<b>84.900,00</b>
<b>Surcharge Base</b>			
Colour group 1		0,00	<b>0,00</b>
Colour group 2		376,00	<b>470,00</b>
<b>Surcharges table top 1495 x 700 mm</b>			
melamine soft light	A1S52	0,00	<b>0,00</b>
MDF powder-coated in soft light	B1S52	3.512,00	<b>4.390,00</b>
MDF powder-coated basic dark	B1S30	3.512,00	<b>4.390,00</b>
light oak	C1S17	6.952,00	<b>8.690,00</b>
black oak	C1S50	6.952,00	<b>8.690,00</b>
<b>Surcharges table top electrification</b>			
not provided	00	0,00	<b>0,00</b>
cut-out for Port 180 on right	01	464,00	<b>580,00</b>
cut-out for Port 180 on left	02	464,00	<b>580,00</b>

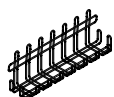

<b>Cable basket</b>		Article no.	without VAT in SEK*	with VAT in SEK*
<b>Steel wire, powder-coated in basic dark</b>	W 444 x D 114 x H 164 mm	<b>210 692 00</b>	944,00	<b>1.180,00</b>

Maximum number of cable baskets for large desk: 3 units; medium desk: 2 units; and small desk: 1 unit

Fabric F40	Fabric F60	Fabric F80	Fabric F120	Legs group 1	Legs group 2
. Laser RE	. Volo	. Cosy 2 . Tress	. Credo . Track	01 chrome 12 deep black powder-coated (smooth)	06 Japanese red powder-coated (smooth) 32 dark grey powder-coated (smooth) 52 soft light powder-coated (smooth) 91 mint powder-coated (smooth)

# Alcove Plus Desk

Ronan & Erwan Bouroullec, 2021

vitra.



Cable outlet with power supply option to be installed in table tops 22-27 mm thick

Port 120	Article no.	without VAT in SEK*	with VAT in SEK*
<b>833 401 01</b>			
<b>Equipment</b>			
without modules	0000		
1x Current Module power	AP01	1.216,00	<b>1.520,00</b>
1x Current Module Data (2x)	AP04	2.496,00	<b>3.120,00</b>
1x Current Module USB charger A-C	AP12	4.224,00	<b>5.280,00</b>
1x Current Module USB charger C	AP15	4.016,00	<b>5.020,00</b>
<b>Surface</b>			
aluminium powder-coated in soft light / plastic in soft light	OF5252	<b>1.328,00</b>	<b>1.660,00</b>
aluminium powder-coated in basic dark / plastic in basic dark	OF3030	1.328,00	<b>1.660,00</b>
aluminium polished / plastic in basic dark	OF0330	1.640,00	<b>2.050,00</b>
<b>Basic price:</b>		<b>1.328,00</b>	<b>1.660,00</b>

**Order:** Optional current module power comes with a GST18 plug. Please order feed and connecting cables separately. Please provide separate cables to connect RJ45 and USB.



Power cable inlet for installation in table tops of thickness 22-27 mm

Port 180	Article no.	without VAT in SEK*	with VAT in SEK*
<b>833 402 01</b>			
<b>Equipment</b>			
without modules	0000		
1x Current Module power	AP01	1.184,00	<b>1.480,00</b>
2x Current Module power	AP02	2.400,00	<b>3.000,00</b>
1x Current power + 1x data 2x	AP03	2.792,00	<b>3.490,00</b>
1x Current power +1 cable hol.	AP05	2.400,00	<b>3.000,00</b>
1x Cur.pow. + 1x VGA, 3,5 jack	AP06	3.584,00	<b>4.480,00</b>
1x Current pow. + 1x RJ45 HDMI	AP07	3.584,00	<b>4.480,00</b>
1x Current power + 1x USB (2x)	AP08	2.792,00	<b>3.490,00</b>
1x Cur.pow. +1x USB charg. A-C	AP13	5.288,00	<b>6.610,00</b>
1x Cur.pow. +1x USB charger C	AP16	5.032,00	<b>6.290,00</b>
<b>Surface</b>			
alum. s.light/ plastic s.light	OF5252	<b>1.544,00</b>	<b>1.930,00</b>
aluminium powder-coated in basic dark / plastic in basic dark	OF3030	1.544,00	<b>1.930,00</b>
aluminium polished / plastic in basic dark	OF0330	1.856,00	<b>2.320,00</b>
<b>Basic price:</b>		<b>1.544,00</b>	<b>1.930,00</b>

**Order:** optional Current modules (power) are supplied with GST18 connectors. A distribution block is required for use of ,2x Current module (power)' (AP02). Please order distribution block and, if necessary, feed cables separately. Cables for RJ45 and USB connections to be provided separately.

# Alcove Plus Desk

Ronan & Erwan Bouroullec, 2021



For attaching table lamps to port cable outlet; inner diameter: 10 mm; including reduction sleeve and assembly materials, excl. lamp.

Lamp adapter for port	Article no.	without VAT in SEK*	with VAT in SEK*
aluminium powder-coated in soft light	<b>853 466 11</b>	752,00	<b>940,00</b>
polished aluminium	<b>853 466 12</b>	856,00	<b>1.070,00</b>



For attaching monitor arms to port cable outlet; inner diameter: 14 mm; including reduction sleeve and assembly materials, excl. monitor arm.

Monitor adapter for port	Article no.	without VAT in SEK*	with VAT in SEK*
aluminium powder-coated in soft light	<b>853 465 11</b>	720,00	<b>900,00</b>
polished aluminium	<b>853 465 12</b>	856,00	<b>1.070,00</b>



Power outlet for workstations with technical unit or for direct attachment to cable basket; without feed cables, connecting cables or patch cables.

**Ordering:** please order feed and connecting cables separately.

Tens Kit 4	Article no.	without VAT in SEK*	with VAT in SEK*
	<b>833 412 01</b>		
<b>Electrification</b>			
DE, AT, NL, ES norm	EL01		
<b>Equipment slot 1</b>			
1x power including housing	1AS01	<b>400,00</b>	<b>500,00</b>
<b>Equipment slot 2</b>			
1x power	2AS01	<b>248,00</b>	<b>310,00</b>
<b>Equipment slot 3</b>			
1x power	3AS01	<b>248,00</b>	<b>310,00</b>
2x RJ45	3AS02	1.408,00	<b>1.760,00</b>
1x HDMI + 1x USB	3AS03	1.792,00	<b>2.240,00</b>
1x VGA + 3 mm jack	3AS04	1.528,00	<b>1.910,00</b>
<b>Equipment slot 4</b>			
1x power	4AS01	<b>248,00</b>	<b>310,00</b>
2x RJ45	4AS02	1.408,00	<b>1.760,00</b>
1x HDMI + 1x USB	4AS03	1.792,00	<b>2.240,00</b>
1x VGA + 3.5mm jack	4AS04	1.528,00	<b>1.910,00</b>
	<b>Basic price:</b>	<b>1.144,00</b>	<b>1.430,00</b>

# Alcove Plus Desk

Ronan & Erwan Bouroullec, 2021

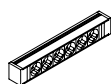

Power outlet for workstations with technical unit or for direct attachment to cable basket; without feed cables, connecting cables or patch cables.

<b>Tens Kit 6</b>	Article no.	without VAT in SEK*	with VAT in SEK*
	<b>833 413 01</b>		
<b>Electrification</b>			
DE, AT, NL, ES norm	EL01		
<b>Equipment slot 1</b>			
1x power including housing	1AS01	<b>472,00</b>	<b>590,00</b>
<b>Equipment slot 2</b>			
1x power	2AS01	<b>248,00</b>	<b>310,00</b>
<b>Equipment slot 3</b>			
1x power	3AS01	<b>248,00</b>	<b>310,00</b>
<b>Equipment slot 4</b>			
1x power	4AS01	<b>248,00</b>	<b>310,00</b>
2x RJ45	4AS02	1.408,00	<b>1.760,00</b>
1x HDMI + 1x USB	4AS03	1.792,00	<b>2.240,00</b>
1x VGA + 3.5mm jack	4AS04	1.528,00	<b>1.910,00</b>
<b>Equipment slot 5</b>			
1x power	5AS01	<b>248,00</b>	<b>310,00</b>
2x RJ45	5AS02	1.408,00	<b>1.760,00</b>
1x HDMI + 1x USB	5AS03	1.792,00	<b>2.240,00</b>
1x VGA + 3.5mm jack	5AS04	1.528,00	<b>1.910,00</b>
<b>Equipment slot 6</b>			
1x power	6AS01	<b>248,00</b>	<b>310,00</b>
2x RJ45	6AS02	1.408,00	<b>1.760,00</b>
1x HDMI + 1x USB	6AS03	1.792,00	<b>2.240,00</b>
1x VGA + 3.5mm jack	6AS04	1.528,00	<b>1.910,00</b>
	<b>Basic price:</b>	<b>1.712,00</b>	<b>2.140,00</b>

**Ordering:** please order feed and connecting cables separately.



# Alcove Plus Desk

Ronan & Erwan Bouroullec, 2021

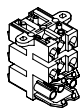

supplies power to up to 5 sockets

<b>Distribution block</b>		Article no.	without VAT in SEK*	with VAT in SEK*
H 60 x W 50 x D 50 mm	black plastic	<b>856 824 00</b>	568,00	<b>710,00</b>



Including 4 zip fasteners

<b>Cable net long</b>		Article no.	without VAT in SEK*	with VAT in SEK*
W 30 x L 1500 mm	polyester basic dark	<b>833 040 02</b>	560,00	<b>700,00</b>
W 30 x L 1500 mm	polyester grey	<b>833 040 12</b>	560,00	<b>700,00</b>



<b>Connection cables</b>		Article no.	without VAT in SEK*	with VAT in SEK*
Connection cable L100	black plastic	<b>853 408 11</b>	432,00	<b>540,00</b>



<b>L300 feed cable</b>		Article no.	without VAT in SEK*	with VAT in SEK*
		<b>833 017 20</b>		
Electrification			656,00	<b>820,00</b>
DE, AT, NL, ES norm with 300 cm power feed cable		ELE01		

# Alcove Plus Paravent

Ronan & Erwan Bouroullec, 2021

vitra.

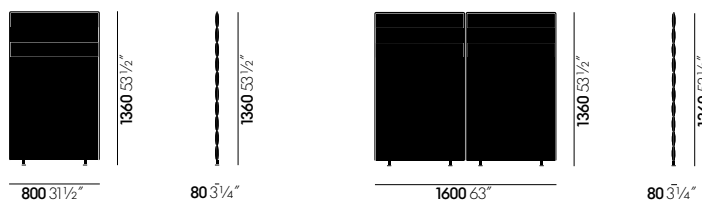

Alcove Plus Paravent

Alcove Plus Paravent one-piece

Alcove Plus Paravent two-piece

All measurements are pursuant to EN 1335-1:2000  
More detailed information is found in the chapter 'Explanation of measurements'.

**Paravent:** panel with organic fibreboard core. Quilted cover with polyester-fibre padding and a zip fastener on both sides for attachment to other Alcove Plus elements: Sofa, Love Seat, Work or Desk.

**Cover:** removable.

**Legs:** steel, chrome-plated or powder-coated (smooth). Felt glides.

**Note:** Alcove Plus Paravents are not designed for free-standing use. They must always be connected to another Alcove Plus element: Sofa, Work or Desk.

## Alcove Plus Paravent one-piece

	Article no.	without VAT in SEK*	with VAT in SEK*
		<b>210 693 00</b>	
Fabric F40		14.000,00	<b>17.500,00</b>
Fabric F60		14.880,00	<b>18.600,00</b>
Fabric F80		16.240,00	<b>20.300,00</b>
Fabric F120		18.640,00	<b>23.300,00</b>
<b>Surcharge Base</b>			
Colour group 1		0,00	<b>0,00</b>
Colour group 2		376,00	<b>470,00</b>

## Alcove Plus Paravent two-piece

	Article no.	without VAT in SEK*	with VAT in SEK*
		<b>210 694 00</b>	
Fabric F40		22.080,00	<b>27.600,00</b>
Fabric F60		23.840,00	<b>29.800,00</b>
Fabric F80		25.680,00	<b>32.100,00</b>
Fabric F120		29.600,00	<b>37.000,00</b>
<b>Surcharge Base</b>			
Colour group 1		0,00	<b>0,00</b>
Colour group 2		376,00	<b>470,00</b>

Fabric F40	Fabric F60	Fabric F80	Fabric F120	Legs group 1	Legs group 2
· Laser RE	· Volo	· Cosy 2 · Tress	· Credo · Track	01 chrome 12 deep black powder-coated (smooth)	06 Japanese red powder-coated (smooth) 32 dark grey powder-coated (smooth) 52 soft light powder-coated (smooth) 91 mint powder-coated (smooth)

# Grand Sofà

Antonio Citterio, 2017

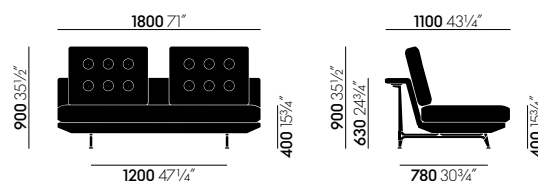

2 1/2-Seater - full backrest, one-piece seat cushion

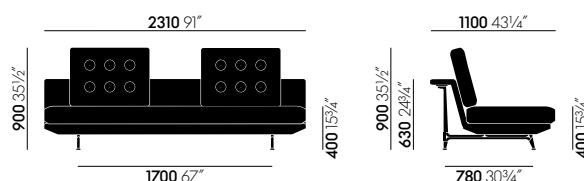

3-Seater - full backrest, one-piece seat cushion

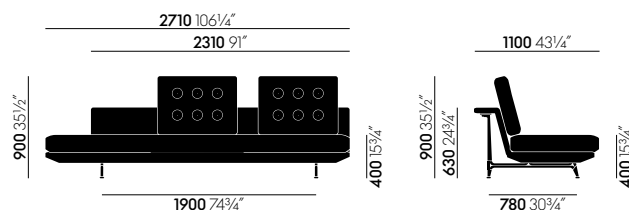

3 1/2-Seater - open on left, one-piece seat cushion

## Grand Sofà

**Body:** metal frame with moulded polyurethane foam.

**Seat cushions:** polyurethane foam core and chamber cushion (filled with polyurethane foam lozenges, latex and a mix of goose feathers and down).

**Lumbar cushion 60 x 30 x 6 cm:** filled with a mix of feathers/down and ball fibre.

**Back cushion 60 x 52 x 8 cm:** filled with a mix of feathers/down and ball fibre.

**Back cushion 70 x 60 x 8 cm:** filled with a mix of feathers/down and ball fibre – combination with neck cushion recommended.

**Back cushion 90 x 60 x 8 cm, latex filling:** heavy filling of latex and feathers – cushion nestles against the angled backrest when used without neck cushion.

**Armrest cushion 59 x 27 x 15 cm:** filled with a mix of feathers/down and ball fibre, sand-weighted.

**Neck cushion 70 x 17 x 15 cm:** filled with a mix of feathers/down and ball fibre, sand-weighted.

**Covers:** removable.

**Legs:** die-cast aluminium, polished or powder-coated.

**Glides:** non-slip.

**Accessory:** Sofa Tray made of steel, covered with split leather.

**Note:** the designations „left“ and „right“ refer to the perspective when viewing the sofa from the front.

**Note:** with the exception of neck and armrest cushions, all cushions are available in a tufted version.

**Note:** back cushions are not included with the sofa and must be ordered separately.

**Note:** cushions should be regularly shaken and plumped to retain their fullness and shape.

**Applications:** recommended for domestic use only.

# Grand Sofà

Antonio Citterio, 2017

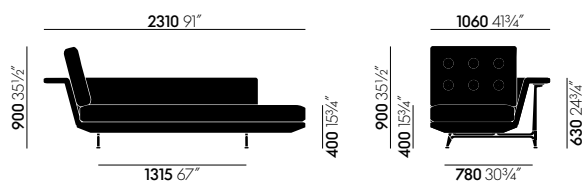

Chaise Longue - right, one-piece seat cushion



Bench

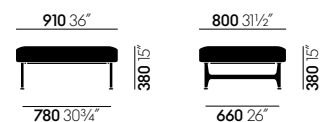

Ottoman

## Grand Sofà Bench

**Structure:** metal frame with wooden panel, polyurethane foam and chamber cushion filled with polyurethane foam lozenges, latex and a mix of goose feathers and down. Cushion in tufted version only.

**Covers:** removable.

**Legs:** die-cast aluminium, polished or powder-coated.

**Glides:** anti-slip glides.

## Grand Sofà Ottoman

**Structure:** wooden panel, polyurethane foam and a chamber cushion filled with polyurethane foam rods, latex and a mix of goose feathers and down. Cushion in tufted version only.

**Covers:** removable.

**Legs:** die-cast aluminium, polished or powder-coated.

**Glides:** anti-slip glides.

**Accessory:** Sofa Tray made of steel, covered with split leather.

# Grand Sofà

Antonio Citterio, 2017

with VAT in SEK\*

	F40 Mello	F80 Corsaro Cosy 2 Dumet Iroko 2 Linho	F100 Reed	F120 Credo	
<b>2½-Seater</b>					
full backrest	<b>210 526 00</b>	73.900,00	78.600,00	81.100,00	83.900,00
surcharge individual seat cushions, tufted		7.890,00	7.890,00	7.890,00	7.890,00
surcharge one-piece seat cushion, tufted		11.900,00	11.900,00	11.900,00	11.900,00
<b>3-Seater</b>					
open on right	<b>210 499 00</b>	79.200,00	84.200,00	87.500,00	91.200,00
open on left	<b>210 498 00</b>	79.200,00	84.200,00	87.500,00	91.200,00
full backrest	<b>210 497 00</b>	79.200,00	84.200,00	87.500,00	91.200,00
surcharge individual seat cushions, tufted		8.490,00	8.490,00	8.490,00	8.490,00
surcharge one-piece seat cushion, tufted		13.300,00	13.300,00	13.300,00	13.300,00
<b>3½-Seater</b>					
open on right	<b>210 525 00</b>	91.000,00	96.800,00	101.200,00	104.600,00
open on left	<b>210 524 00</b>	91.000,00	96.800,00	101.200,00	104.600,00
full backrest	<b>210 523 00</b>	91.000,00	96.800,00	101.200,00	104.600,00
surcharge individual seat cushions, tufted		9.550,00	9.550,00	9.550,00	9.550,00
surcharge one-piece seat cushion, tufted		15.200,00	15.200,00	15.200,00	15.200,00
<b>Chaise Longue</b>					
right	<b>210 528 00</b>	75.500,00	80.500,00	83.300,00	87.000,00
left	<b>210 527 00</b>	75.500,00	80.500,00	83.300,00	87.000,00
surcharge individual seat cushions, tufted		8.090,00	8.090,00	8.090,00	8.090,00
surcharge one-piece seat cushion, tufted		12.700,00	12.700,00	12.700,00	12.700,00
<b>Ottoman</b>					
tufted cushion	<b>210 537 00</b>	31.600,00	32.900,00	33.500,00	34.400,00
<b>Bench</b>					
tufted cushion	<b>210 539 00</b>	54.700,00	56.600,00	58.300,00	59.600,00

# Grand Sofà

Antonio Citterio, 2017

vitra.

with VAT in SEK\*

F40  
Mello

F80  
Corsaro  
Cosy 2  
Dumet  
Iroko 2  
Linho  
Savana

F100  
Nubia  
Reed

F120  
Credo

## backrest cushions

60 x 52 x 8 cm	<b>210 529 00</b>	3.650,00	4.690,00	5.450,00	6.090,00
surcharge tufted upholstery		460,00	460,00	460,00	460,00
70 x 60 x 8 cm	<b>210 530 00</b>	4.590,00	5.850,00	6.690,00	7.450,00
surcharge tufted upholstery		600,00	600,00	600,00	600,00
90 x 60 x 8 cm, latex filling	<b>210 532 00</b>	5.100,00	6.690,00	7.550,00	8.490,00
surcharge tufted upholstery		650,00	650,00	650,00	650,00

## lumbar cushion

60 x 30 x 6 cm	<b>210 533 00</b>	2.790,00	3.650,00	3.990,00	4.550,00
surcharge tufted upholstery		340,00	340,00	340,00	340,00

## neck support cushion

70 x 17 x 15 cm	<b>210 534 00</b>	2.650,00	3.850,00	4.550,00	5.250,00
-----------------	-------------------	----------	----------	----------	----------

## armrest cushion

59 x 27 x 15 cm	<b>210 535 00</b>	3.250,00	4.450,00	5.250,00	5.850,00
-----------------	-------------------	----------	----------	----------	----------

# Grand Sofà

Antonio Citterio, 2017

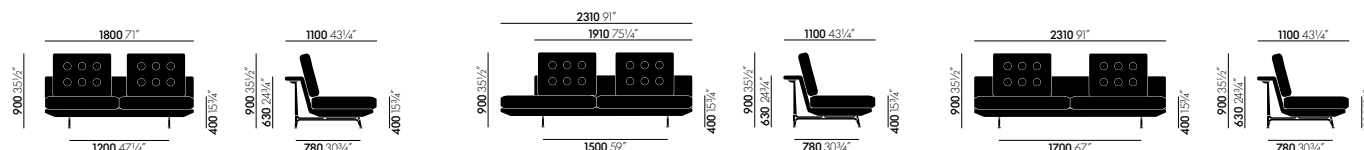

2½-Seater - full backrest, individual seat cushions

3-Seater - open on left, individual seat cushions

3-Seater - full backrest, individual seat cushions

## Grand Sofà 2½-Seater

	Article no.	without VAT in SEK*	with VAT in SEK*
	<b>210 526 00</b>		
Fabric F40		59.120,00	<b>73.900,00</b>
Fabric F80		62.880,00	<b>78.600,00</b>
Fabric F100		64.880,00	<b>81.100,00</b>
Fabric F120		67.120,00	<b>83.900,00</b>

### Surcharge for tufting and seat cushions

seat cushion, divided, non-tufted	01	0,00	<b>0,00</b>
individual seat cushions, tufted	02	6.312,00	<b>7.890,00</b>
seat cushion, one-piece, tufted	03	9.520,00	<b>11.900,00</b>

## Grand Sofà 3-Seater

	Article no.	without VAT in SEK*	with VAT in SEK*
<b>open on right</b>	<b>210 499 00</b>		
Fabric F40		63.360,00	<b>79.200,00</b>
Fabric F80		67.360,00	<b>84.200,00</b>
Fabric F100		70.000,00	<b>87.500,00</b>
Fabric F120		72.960,00	<b>91.200,00</b>
<b>open on left</b>	<b>210 498 00</b>		
Fabric F40		63.360,00	<b>79.200,00</b>
Fabric F80		67.360,00	<b>84.200,00</b>
Fabric F100		70.000,00	<b>87.500,00</b>
Fabric F120		72.960,00	<b>91.200,00</b>
<b>full backrest</b>	<b>210 497 00</b>		
Fabric F40		63.360,00	<b>79.200,00</b>
Fabric F80		67.360,00	<b>84.200,00</b>
Fabric F100		70.000,00	<b>87.500,00</b>
Fabric F120		72.960,00	<b>91.200,00</b>

### Surcharge for tufting and seat cushions

Upholstery version seat cushion, divided, non-tufted	01	0,00	<b>0,00</b>
Upholstery version individual seat cushions, tufted	02	6.792,00	<b>8.490,00</b>
Upholstery version seat cushion, one-piece, tufted	03	10.640,00	<b>13.300,00</b>

Fabric F40	Fabric F80	Fabric F100	Fabric F120	Base
. Mello	. Corsaro	. Nubia	. Credo	03 polished aluminium
	. Cosy 2	. Reed		30 basic dark powder-coated (smooth)
	. Dumet			
	. Iroko 2			
	. Linho			
	. Savana			

# Grand Sofà

Antonio Citterio, 2017

vitra.

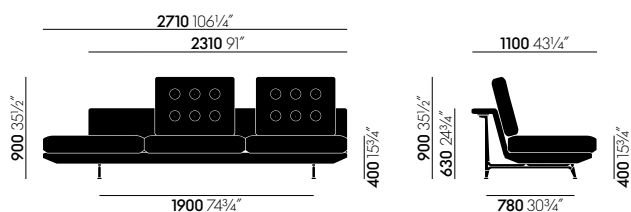

3 1/2-Seater - open on left, individual seat cushions

## Grand Sofà 3 1/2-Seater

	Article no.	without VAT in SEK*	with VAT in SEK*
<b>open on right</b>	<b>210 525 00</b>		
Fabric F40		72.800,00	91.000,00
Fabric F80		77.440,00	96.800,00
Fabric F100		80.960,00	101.200,00
Fabric F120		83.680,00	104.600,00
<b>open on left</b>	<b>210 524 00</b>		
Fabric F40		72.800,00	91.000,00
Fabric F80		77.440,00	96.800,00
Fabric F100		80.960,00	101.200,00
Fabric F120		83.680,00	104.600,00
<b>full backrest</b>	<b>210 523 00</b>		
Fabric F40		72.800,00	91.000,00
Fabric F80		77.440,00	96.800,00
Fabric F100		80.960,00	101.200,00
Fabric F120		83.680,00	104.600,00

### Surcharge for tufting and seat cushions

Upholstery version seat cushion, divided, non-tufted	01	0,00	0,00
Upholstery version individual seat cushions, tufted	02	7.640,00	9.550,00
Upholstery version seat cushion, one-piece, tufted	03	12.160,00	15.200,00

Fabric F40	Fabric F80	Fabric F100	Fabric F120	Base
. Mello	. Corsaro	. Nubia	. Credo	03 polished aluminium
	. Cosy 2	. Reed		30 basic dark powder-coated (smooth)
	. Dumet			
	. Iroko 2			
	. Linho			
	. Savana			



# Grand Sofà

Antonio Citterio, 2017

vitra.

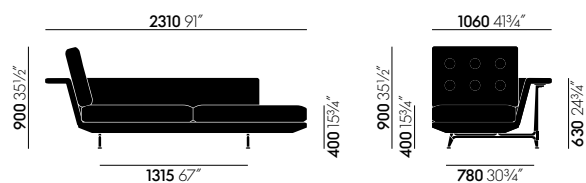
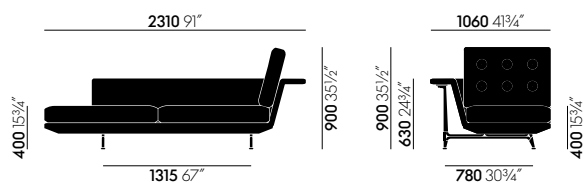

Chaise Longue - left, individual seat cushions

Chaise Longue - right, individual seat cushions

## Grand Sofà Chaise Longue

	Article no.	without VAT in SEK*	with VAT in SEK*
<b>right</b>	<b>210 528 00</b>		
Fabric F40		60.400,00	<b>75.500,00</b>
Fabric F80		64.400,00	<b>80.500,00</b>
Fabric F100		66.640,00	<b>83.300,00</b>
Fabric F120		69.600,00	<b>87.000,00</b>
<b>left</b>	<b>210 527 00</b>		
Fabric F40		60.400,00	<b>75.500,00</b>
Fabric F80		64.400,00	<b>80.500,00</b>
Fabric F100		66.640,00	<b>83.300,00</b>
Fabric F120		69.600,00	<b>87.000,00</b>

### Surcharge for tufting and seat cushions

Upholstery version seat cushion, divided, non-tufted	01	0,00	<b>0,00</b>
Upholstery version individual seat cushions, tufted	02	6.472,00	<b>8.090,00</b>
Upholstery version seat cushion, one-piece, tufted	03	10.160,00	<b>12.700,00</b>

Fabric F40	Fabric F80	Fabric F100	Fabric F120	Base
. Mello	. Corsaro	. Nubia	. Credo	03 polished aluminium
	. Cosy 2	. Reed		30 basic dark powder-coated (smooth)
	. Dumet			
	. Iroko 2			
	. Linho			
	. Savana			

# Grand Sofà

Antonio Citterio, 2017

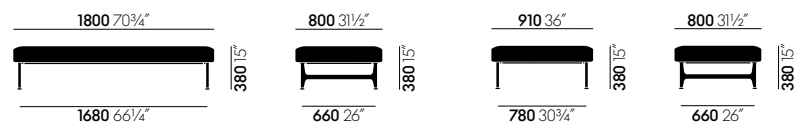

Bench

Ottoman

## Grand Sofà Bench

	Article no.	without VAT in SEK*	with VAT in SEK*
<b>Tufted cushion</b>	<b>210 539 00</b>		
Fabric F40		43.760,00	<b>54.700,00</b>
Fabric F80		45.280,00	<b>56.600,00</b>
Fabric F100		46.640,00	<b>58.300,00</b>
Fabric F120		47.680,00	<b>59.600,00</b>

## Grand Sofà Ottoman

	Article no.	without VAT in SEK*	with VAT in SEK*
<b>Tufted cushion</b>	<b>210 537 00</b>		
Fabric F40		25.280,00	<b>31.600,00</b>
Fabric F80		26.320,00	<b>32.900,00</b>
Fabric F100		26.800,00	<b>33.500,00</b>
Fabric F120		27.520,00	<b>34.400,00</b>

Fabric F40	Fabric F80	Fabric F100	Fabric F120	Base
. Mello	. Corsaro . Cosy 2 . Dumet . Iroko 2 . Linho . Savana	. Nubia . Reed	. Credo	03 polished aluminium 30 basic dark powder-coated (smooth)

# Grand Sofà

Antonio Citterio, 2017

**vitra.**

<b>Grand Sofà backrest cushions</b>	Article no.	without VAT in SEK*	with VAT in SEK*
<b>60 x 52 x 8 cm</b>	<b>210 529 00</b>		
Fabric F40		2.920,00	<b>3.650,00</b>
Fabric F80		3.752,00	<b>4.690,00</b>
Fabric F100		4.360,00	<b>5.450,00</b>
Fabric F120		4.872,00	<b>6.090,00</b>

## Surcharge tufting

Upholstery version non-tufted	01	0,00	<b>0,00</b>
Upholstery version tufted	02	368,00	<b>460,00</b>

<b>70 x 60 x 8 cm</b>	<b>210 530 00</b>		
Fabric F40		3.672,00	<b>4.590,00</b>
Fabric F80		4.680,00	<b>5.850,00</b>
Fabric F100		5.352,00	<b>6.690,00</b>
Fabric F120		5.960,00	<b>7.450,00</b>

## Surcharge tufting

Upholstery version non-tufted	01	0,00	<b>0,00</b>
Upholstery version tufted	02	480,00	<b>600,00</b>

<b>90 x 60 x 8 cm, latex filling</b>	<b>210 532 00</b>		
Fabric F40		4.080,00	<b>5.100,00</b>
Fabric F80		5.352,00	<b>6.690,00</b>
Fabric F100		6.040,00	<b>7.550,00</b>
Fabric F120		6.792,00	<b>8.490,00</b>

## Surcharge tufting

Upholstery version non-tufted	01	0,00	<b>0,00</b>
Upholstery version tufted	02	520,00	<b>650,00</b>

Fabric F40	Fabric F80	Fabric F100	Fabric F120
. Mello	. Corsaro . Cosy 2 . Dumet . Iroko 2 . Linho . Savana	. Nubia . Reed	. Credo



# Grand Sofà

Antonio Citterio, 2017

**vitra.**

## Grand Sofà lumbar cushion

	Article no.	without VAT in SEK*	with VAT in SEK*
<b>60 x 30 x 6 cm</b>	<b>210 533 00</b>		
Fabric F40		2.232,00	<b>2.790,00</b>
Fabric F80		2.920,00	<b>3.650,00</b>
Fabric F100		3.192,00	<b>3.990,00</b>
Fabric F120		3.640,00	<b>4.550,00</b>
<b>Surcharge tufting</b>			
Upholstery version non-tufted	01	0,00	<b>0,00</b>
Upholstery version tufted	02	272,00	<b>340,00</b>

## Grand Sofà neck support cushion

	Article no.	without VAT in SEK*	with VAT in SEK*
<b>70 x 17 x 15 cm</b>	<b>210 534 00</b>		
Fabric F40		2.120,00	<b>2.650,00</b>
Fabric F80		3.080,00	<b>3.850,00</b>
Fabric F100		3.640,00	<b>4.550,00</b>
Fabric F120		4.200,00	<b>5.250,00</b>

## Grand Sofà armrest cushion

	Article no.	without VAT in SEK*	with VAT in SEK*
<b>59 x 27 x 15 cm</b>	<b>210 535 00</b>		
Fabric F40		2.600,00	<b>3.250,00</b>
Fabric F80		3.560,00	<b>4.450,00</b>
Fabric F100		4.200,00	<b>5.250,00</b>
Fabric F120		4.680,00	<b>5.850,00</b>

Fabric F40	Fabric F80	Fabric F100	Fabric F120
. Mello	. Corsaro	. Nubia	. Credo
	. Cosy 2	. Reed	
	. Dumet		
	. Iroko 2		
	. Linho		
	. Savana		

# Sofa Tray

Antonio Citterio, 2017

vitra.

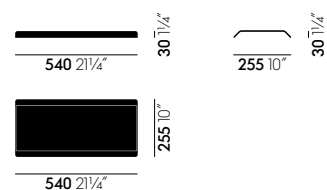

**Material:** steel, covered with split leather.

## Sofa Tray

540 x 254 x 30 mm

covered with Leather Forte (Deco)

Article no. without VAT in SEK\* with VAT in SEK\*

210 536 00

3.400,00

4.250,00

### Leather Forte (deco)

- 01 cognac (dark)
- 02 marron (dark)
- 03 umbra grey
- 04 chocolate
- 05 nero
- 07 sand

# Freeform Sofa

Isamu Noguchi, 1946

vitra.

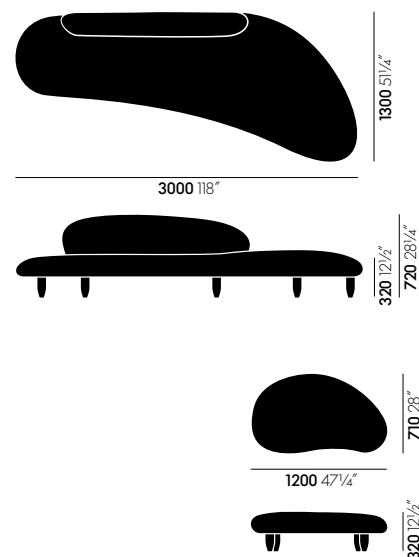

**Frame:** solid beech.

**Body and cushions:** wooden frame with polyurethane foam.

**Covers:** removable.

**Seat height:** 320 mm (280 mm with applied load, measured in accordance with EN 1335-1).

**Legs:** solid maple, natural finish or walnut stain.

**Origin of wood:** beech (*Fagus sylvatica*), maple (*Acer platanoides*) and walnut (*Juglans regia*) from Poland and Austria.

Freeform Sofa	Article no.	without VAT in SEK*	with VAT in SEK*
	<b>210 182 00</b>		
Fabric F120		89.680,00	<b>112.100,00</b>

Ottoman	Article no.	without VAT in SEK*	with VAT in SEK*
	<b>210 181 00</b>		
Fabric F120		25.120,00	<b>31.400,00</b>

Fabric F120

Legs

. Credo

maple, stained walnut-coloured  
54 maple

# Mariposa Club Armchair

Edward Barber & Jay Osgerby, 2017

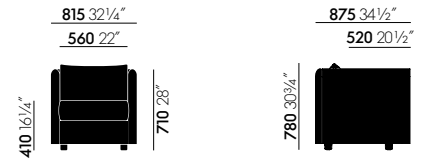

All measurements are pursuant to EN 1335-1:2000  
More detailed information is found in the chapter 'Explanation of measurements'.

- Structural frame:** webbed metal frame with polyurethane foam.
- Seat cushions:** multilayer PU foam upholstery.
- Back cushions:** foam cube and ball fibre filling; back cushions attached to backrest by zip fastener.
- Seat height:** 410 mm (309 mm with applied load, measured in accordance with EN 1335-1:2000).
- Covers:** removable.
- Glides:** plastic glides with levelling adjustment.

## Mariposa Club Armchair

	Article no.	without VAT in SEK*	with VAT in SEK*
	<b>210 480 00</b>		
Fabric F30		24.800,00	<b>31.000,00</b>
Fabric F40		25.440,00	<b>31.800,00</b>
Fabric F60		26.560,00	<b>33.200,00</b>
Fabric F80		27.840,00	<b>34.800,00</b>
Fabric F100		28.880,00	<b>36.100,00</b>
Fabric F120		31.280,00	<b>39.100,00</b>

Fabric F30	Fabric F40	Fabric F60	Fabric F80	Fabric F100	Fabric F120
. Plano	. Laser RE . Mello	. Olimpo . Volo	. Corsaro . Dumet . Iroko 2 . Linho . Savana	. Aura . Nubia . Reed	. Credo

# Mariposa Sofa

Edward Barber & Jay Osgerby, 2014

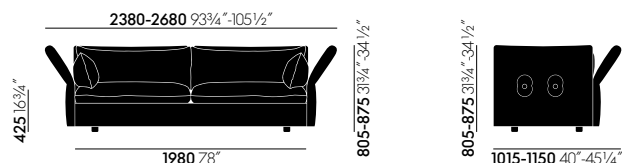

Mariposa 3-Seater

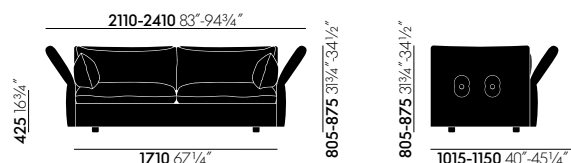

Mariposa 2½-Seater

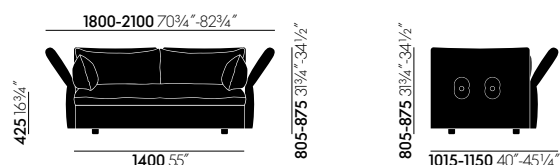

Mariposa 2-Seater

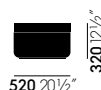

Mariposa Ottoman large

Mariposa Ottoman medium

All measurements are pursuant to EN 1335-1:2000  
More detailed information is found in the chapter 'Explanation of measurements'.

**Structural frame:** webbed metal frame with polyurethane foam.

**Seat cushions:** polyurethane and visco foams with chamber cushion overlay. Chamber cushion overlay filled with feathers and PU rods.

**Back and armrest cushions:** chamber cushion filled with stripped-quill feathers and PU rods.

**Covers:** removable.

**Seat height:** 425 mm (280 mm with applied load, measured in accordance with EN 1335-1:2000).

**Glides:** plastic glides with levelling adjustment.

**Note:** cushions should be regularly shaken and plumped to retain their fullness and shape.

**Applications:** recommended for home use only.

**Note:** for transport purposes Mariposa can be partially disassembled. The instructions can be found in the SSE.

## Mariposa Ottoman

**Base:** MDF board with felt glides.

**Upholstery:** polyurethane foam with polyester fleece.

**Range of use:** recommended for residential use only.



# Mariposa Sofa

Edward Barber & Jay Osgerby, 2014

**vitra.**

<b>Mariposa 3-Seater</b>		Article no.	without VAT in SEK*	with VAT in SEK*
			<b>210 452 00</b>	
Fabric F40			69.680,00	<b>87.100,00</b>
Fabric F60			74.960,00	<b>93.700,00</b>
Fabric F80			80.400,00	<b>100.500,00</b>
Fabric F100			88.800,00	<b>111.000,00</b>
Fabric F120			97.120,00	<b>121.400,00</b>
<b>Mariposa 2 1/2-Seater</b>		Article no.	without VAT in SEK*	with VAT in SEK*
			<b>210 453 00</b>	
Fabric F40			60.800,00	<b>76.000,00</b>
Fabric F60			65.520,00	<b>81.900,00</b>
Fabric F80			70.080,00	<b>87.600,00</b>
Fabric F100			77.280,00	<b>96.600,00</b>
Fabric F120			84.320,00	<b>105.400,00</b>
<b>Mariposa 2-Seater</b>		Article no.	without VAT in SEK*	with VAT in SEK*
			<b>210 451 00</b>	
Fabric F40			53.040,00	<b>66.300,00</b>
Fabric F60			56.560,00	<b>70.700,00</b>
Fabric F80			60.800,00	<b>76.000,00</b>
Fabric F100			67.360,00	<b>84.200,00</b>
Fabric F120			73.280,00	<b>91.600,00</b>
<b>Mariposa Ottoman large</b>		Article no.	without VAT in SEK*	with VAT in SEK*
			<b>210 455 00</b>	
Fabric F40			8.960,00	<b>11.200,00</b>
Fabric F60			9.760,00	<b>12.200,00</b>
Fabric F80			10.320,00	<b>12.900,00</b>
Fabric F100			11.680,00	<b>14.600,00</b>
Fabric F120			12.400,00	<b>15.500,00</b>
<b>Mariposa Ottoman medium</b>		Article no.	without VAT in SEK*	with VAT in SEK*
			<b>210 454 00</b>	
Fabric F40			7.240,00	<b>9.050,00</b>
Fabric F60			7.800,00	<b>9.750,00</b>
Fabric F80			8.400,00	<b>10.500,00</b>
Fabric F100			9.120,00	<b>11.400,00</b>
Fabric F120			10.000,00	<b>12.500,00</b>

Fabric F40	Fabric F60	Fabric F80	Fabric F100	Fabric F120
. Laser RE	. Olimpo	. Corsaro	. Aura	. Credo
. Mello	. Volo	. Dumet	. Nubia	
		. Iroko 2	. Reed	
		. Linho		
		. Savana		



# Mariposa Sofa

Edward Barber & Jay Osgerby, 2014

vitra.

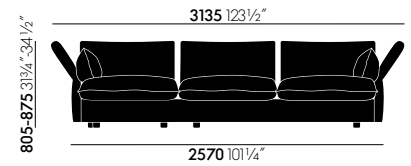
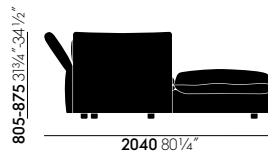
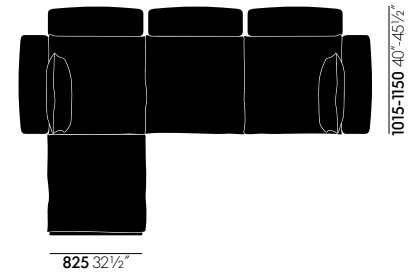

All measurements are pursuant to EN 1335-1:2000  
More detailed information is found in the chapter 'Explanation of measurements'.

**Structural frame:** webbed metal frame with polyurethane foam.

**Seat cushions:** polyurethane and visco foams with chamber cushion overlay. Chamber cushion overlay filled with feathers and PU rods.

**Back and armrest cushions:** chamber cushion filled with stripped-quill feathers and PU rods.

**Covers:** removable.

**Seat height:** 425 mm (280 mm with applied load, measured in accordance with EN 1335-1:2000).

**Glides:** plastic glides with levelling adjustment.

**Applications:** recommended for domestic use only.

**Note:** the designations ‚left‘ and ‚right‘ refer to the perspective when viewing the sofa from the front.

## Mariposa Corner

	Article no.	without VAT in SEK*	with VAT in SEK*
	<b>210 650 00</b>		
Fabric F40		116.800,00	<b>146.000,00</b>
Fabric F60		122.880,00	<b>153.600,00</b>
Fabric F80		132.240,00	<b>165.300,00</b>
Fabric F100		143.120,00	<b>178.900,00</b>
Fabric F120		154.320,00	<b>192.900,00</b>

Fabric F40	Fabric F60	Fabric F80	Fabric F100	Fabric F120	Configuration Chaise Longue
<ul style="list-style-type: none"> <li>. Laser RE</li> <li>. Mello</li> </ul>	<ul style="list-style-type: none"> <li>. Olimpo</li> <li>. Volo</li> </ul>	<ul style="list-style-type: none"> <li>. Corsaro</li> <li>. Dumet</li> <li>. Iroko 2</li> <li>. Linho</li> <li>. Savana</li> </ul>	<ul style="list-style-type: none"> <li>. Aura</li> <li>. Nubia</li> <li>. Reed</li> </ul>	<ul style="list-style-type: none"> <li>. Credo</li> </ul>	<ul style="list-style-type: none"> <li>01/R Chaise Longue right / sitting left</li> <li>02/L Chaise Longue left / sitting right</li> </ul>

# Polder

Hella Jongerius, 2005/2015



Polder Sofa

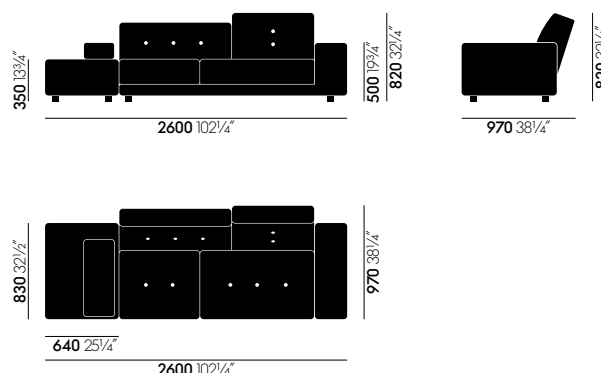

Polder Compact

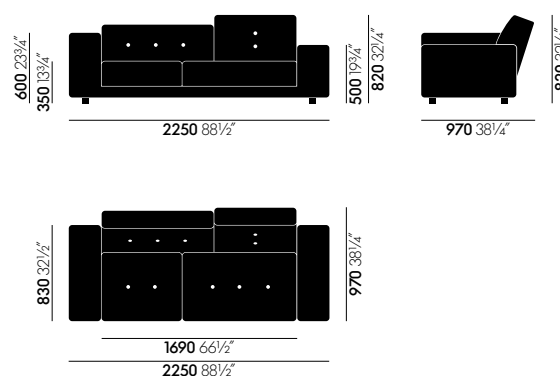

Polder Ottoman

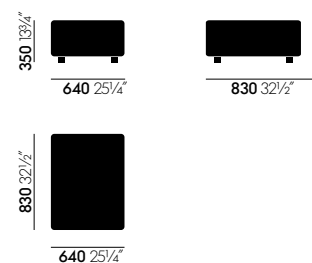

**Structural frame:** wooden frame.

**Seat cushions:** polyurethane foam with interactive pocket spring core, chamber cushion structure (filled with foam cubes and lozenges) and polyester fleece.

**Back cushions:** polyurethane foam with polyester fleece and chamber cushions (filled with foam cubes and lozenges).

**Armrest cushion:** detached bolster, freely positionable, sand-weighted, polyurethane foam filling.

**Cover:** coordinated combinations of various colours and fabric types, removable.

**Buttons:** made of wood or horn, colour and grain subject to natural variations.

**Ottoman:** wooden frame with polyurethane foam. The fabric and colour of the Ottoman matches that of the sofa.

**Applications:** recommended for domestic use only.

**Note:** you will find an overview of the colour and fabric combinations for the different sofa versions in the appendix 'Colour & Material Library'.

**Note:** the designations 'left' and 'right' refer to the perspective when viewing the sofa from the front.

<b>Polder Sofa</b>	Article no.	without VAT in SEK*	with VAT in SEK*
	<b>210 754 00</b>		
fabric		64.080,00	<b>80.100,00</b>

<b>Polder Compact</b>	Article no.	without VAT in SEK*	with VAT in SEK*
	<b>210 755 00</b>		
fabric		58.000,00	<b>72.500,00</b>

<b>Polder Ottoman</b>	Article no.	without VAT in SEK*	with VAT in SEK*
	<b>210 756 00</b>		
fabric		11.440,00	<b>14.300,00</b>

**Fabric mix „The Sea Greens“**

05 Aura - steel blue  
08 Volo - green-grey  
13 Canvas (836)  
17 Cosy 2 - reed green  
20 Credo - dolphin/steel blue  
28 Dumet - sage/steel blue

**Fabric mix „The Antarctic Blues“**

11 Volo - night blue  
18 Tress - royal blue melange  
19 Reed - indigo  
21 Cosy 2 - dark blue  
31 Dumet - indigo melange  
37 Remix (762)

**Fabric mix „The Earth Reds“**

10 Reed - brick  
15 Cosy 2 - rusty orange  
15 Track - brick/dark red  
53 Aura - poppy red  
77 Volo - brick  
77 Aura - brick

**Fabric mix „The Pebble Greys“**

03 Aura - sand  
03 Mello - cement  
03 Reed - stone  
07 Track - mid-grey/cream  
10 Canvas (124)  
14 Volo - iron grey

**Configuration armrests Polder Compact**

01/R Low armrest right/sitting left  
02/L Low armrest left/sitting right

**Configuration armrest Polder Sofa**

01/R Armrest right/sitting left  
02/L Armrest left/sitting right

**Set of buttons**

01 Light set of buttons  
02 Dark set of buttons

# Soft Modular Sofa

Jasper Morrison, 2016

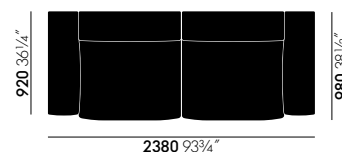

Two seater

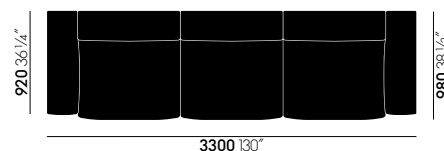

Three seater

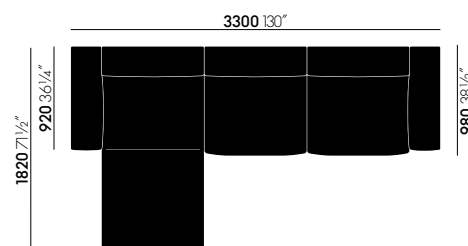

Three seater with Chaise Longue

All measurements are pursuant to EN 1335-1:2000

More detailed information is found in the chapter 'Explanation of measurements'.

## Soft Modular Sofa

**Seat:** steel frame, wood construction with steel springs, polyurethane foam structure and visco cover.

**Seat height:** 380 mm (270 mm with applied load, measured in accordance with EN 1335-1:2000).

**Armrests and backrest:** wood construction with polyurethane foam structure and chamber cushion overlay (filling made of polyurethane foam rods and polyester fibres).

**Covers:** removable.

**Throw cushions:** foam cube and ball fibre filling.

**Neck cushion:** polypropylene pellet filling.

**Glides:** plastic glides with levelling adjustment.

**Ottoman structure:** wood construction, steel springs and polyurethane foam structure with visco cover.

**Note:** the designations ,left' and ,right' refer to the perspective when viewing the sofa from the front.

**Note:** corner elements are not suited as end units.

**Note:** the armrests are available in high or low versions.

# Soft Modular Sofa

Jasper Morrison, 2016

**vitra.**

with VAT in SEK*	F40 Laser RE Mello	F60 Olimpo Volo	F80 Cosy 2 Dumet Iroko 2 Linho Savana Tress	F100 Aura Nubia Reed	F120 Credo Track	L20 Leather	L50 Leather Premium F	
<b>Lateral part</b>								
Lateral part, right	<b>210 460 00</b>	28.900,00	30.400,00	32.900,00	34.500,00	36.400,00	42.500,00	61.700,00
Lateral part, left	<b>210 461 00</b>	28.900,00	30.400,00	32.900,00	34.500,00	36.400,00	42.500,00	61.700,00
<b>Central part</b>								
Central part	<b>210 462 00</b>	25.400,00	25.800,00	27.300,00	28.900,00	29.900,00	35.000,00	47.000,00
<b>Platform</b>								
Platform, right	<b>210 494 00</b>	20.600,00	22.000,00	22.800,00	23.600,00	25.400,00	28.900,00	39.400,00
Platform, left	<b>210 495 00</b>	20.600,00	22.000,00	22.800,00	23.600,00	25.400,00	28.900,00	39.400,00
Platform, central	<b>210 496 00</b>	20.600,00	22.000,00	22.800,00	23.600,00	25.400,00	28.900,00	39.400,00
<b>Corner part</b>								
Corner element, right	<b>210 463 00</b>	31.300,00	33.400,00	35.000,00	36.400,00	38.200,00	45.000,00	61.700,00
Corner element, left	<b>210 464 00</b>	31.300,00	33.400,00	35.000,00	36.400,00	38.200,00	45.000,00	61.700,00
<b>Chaise Longue</b>								
Chaise Longue, right	<b>210 465 00</b>	39.400,00	41.900,00	44.300,00	47.000,00	49.500,00	57.800,00	80.700,00
Chaise Longue, left	<b>210 466 00</b>	39.400,00	41.900,00	44.300,00	47.000,00	49.500,00	57.800,00	80.700,00
<b>Ottoman</b>								
Ottoman	<b>210 467 00</b>	16.000,00	17.500,00	18.300,00	19.000,00	19.800,00	23.600,00	31.300,00
<b>Cushions</b>								
Cushion 30 x 40 cm	<b>210 470 00</b>	1.140,00	1.460,00	1.600,00	1.750,00	2.090,00	2.450,00	3.550,00
Cushion 40 x 40 cm	<b>210 471 00</b>	1.300,00	1.600,00	1.750,00	1.900,00	2.200,00	2.590,00	4.150,00
Cushion 50 x 50 cm	<b>210 472 00</b>	1.460,00	1.750,00	2.090,00	2.200,00	2.590,00	3.000,00	5.050,00
Neck cushion, short	<b>210 468 00</b>	1.000,00	1.300,00	1.460,00	1.750,00	1.900,00	2.200,00	3.550,00
Neck cushion, long	<b>210 469 00</b>	1.900,00	2.200,00	2.750,00	3.250,00	3.550,00	4.250,00	6.600,00

# Soft Modular Sofa

## Jasper Morrison, 2016

vitra.

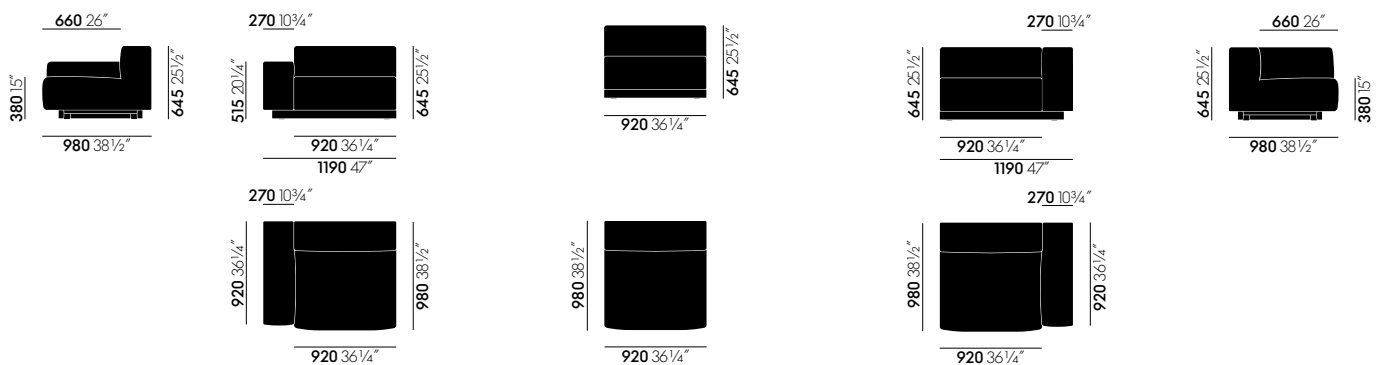

Side element left - low armrest

Central element

Side element right - high armrest

All measurements are pursuant to EN 1335-1:2000  
More detailed information is found in the chapter 'Explanation of measurements'.

### Soft Modular Sofa side elements

	Article no.	without VAT in SEK*	with VAT in SEK*
<b>Lateral part right</b>	<b>210 460 00</b>		
Fabric F40		23.120,00	<b>28.900,00</b>
Fabric F60		24.320,00	<b>30.400,00</b>
Fabric F80		26.320,00	<b>32.900,00</b>
Fabric F100		27.600,00	<b>34.500,00</b>
Fabric F120		29.120,00	<b>36.400,00</b>
Leather L20		34.000,00	<b>42.500,00</b>
Leather L50		49.360,00	<b>61.700,00</b>
<b>Lateral part left</b>	<b>210 461 00</b>		
Fabric F40		23.120,00	<b>28.900,00</b>
Fabric F60		24.320,00	<b>30.400,00</b>
Fabric F80		26.320,00	<b>32.900,00</b>
Fabric F100		27.600,00	<b>34.500,00</b>
Fabric F120		29.120,00	<b>36.400,00</b>
Leather L20		34.000,00	<b>42.500,00</b>
Leather L50		49.360,00	<b>61.700,00</b>

### Soft Modular Sofa central part

	Article no.	without VAT in SEK*	with VAT in SEK*
<b>Central part</b>	<b>210 462 00</b>		
Fabric F40		20.320,00	<b>25.400,00</b>
Fabric F60		20.640,00	<b>25.800,00</b>
Fabric F80		21.840,00	<b>27.300,00</b>
Fabric F100		23.120,00	<b>28.900,00</b>
Fabric F120		23.920,00	<b>29.900,00</b>
Leather L20		28.000,00	<b>35.000,00</b>
Leather L50		37.600,00	<b>47.000,00</b>

Fabric F40	Fabric F60	Fabric F80	Fabric F100	Fabric F120	Leather L20	Leather L50	Height armrests
. Laser RE . Mello	. Olimpo . Volo	. Cosy 2 . Dumet . Iroko 2 . Linho . Savana . Tress	. Aura . Nubia . Reed	. Credo . Track	. Leather	. Leather Premium F	01 low 02 high

# Soft Modular Sofa

Jasper Morrison, 2016

**vitra.**

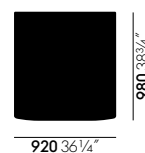
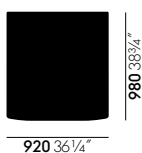
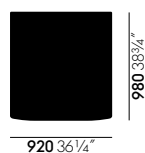
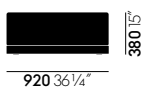
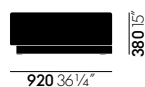

**Platform left**

**Platform central**

**Platform right**

All measurements are pursuant to EN 1335-1:2000  
More detailed information is found in the chapter 'Explanation of measurements'.

## Soft Modular Sofa platform

	Article no.	without VAT in SEK*	with VAT in SEK*
<b>Platform right</b>	<b>210 494 00</b>		
Fabric F40		16.480,00	<b>20.600,00</b>
Fabric F60		17.600,00	<b>22.000,00</b>
Fabric F80		18.240,00	<b>22.800,00</b>
Fabric F100		18.880,00	<b>23.600,00</b>
Fabric F120		20.320,00	<b>25.400,00</b>
Leather L20		23.120,00	<b>28.900,00</b>
Leather L50		31.520,00	<b>39.400,00</b>
<b>Platform left</b>	<b>210 495 00</b>		
Fabric F40		16.480,00	<b>20.600,00</b>
Fabric F60		17.600,00	<b>22.000,00</b>
Fabric F80		18.240,00	<b>22.800,00</b>
Fabric F100		18.880,00	<b>23.600,00</b>
Fabric F120		20.320,00	<b>25.400,00</b>
Leather L20		23.120,00	<b>28.900,00</b>
Leather L50		31.520,00	<b>39.400,00</b>
<b>Platform central</b>	<b>210 496 00</b>		
Fabric F40		16.480,00	<b>20.600,00</b>
Fabric F60		17.600,00	<b>22.000,00</b>
Fabric F80		18.240,00	<b>22.800,00</b>
Fabric F100		18.880,00	<b>23.600,00</b>
Fabric F120		20.320,00	<b>25.400,00</b>
Leather L20		23.120,00	<b>28.900,00</b>
Leather L50		31.520,00	<b>39.400,00</b>



## Soft Modular Sofa

Jasper Morrison, 2016

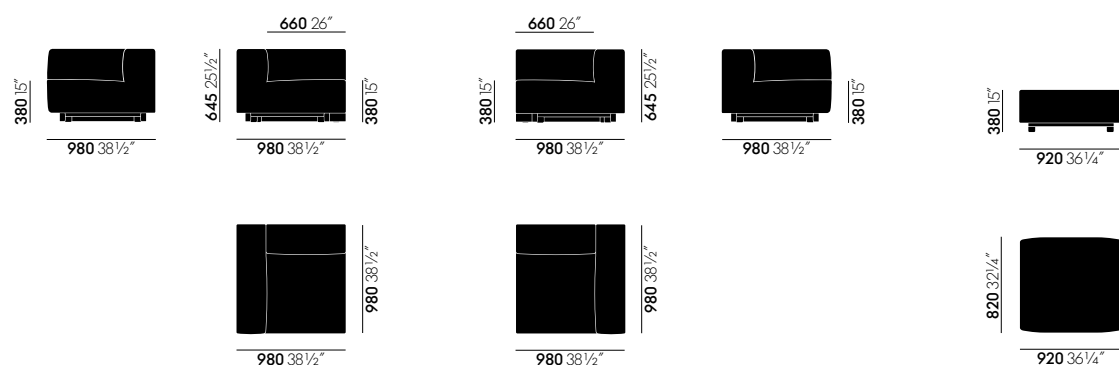

Corner element left

Corner element right

Ottoman

All measurements are pursuant to EN 1335-1:2000  
 More detailed information is found in the chapter 'Explanation of measurements'.

## Soft Modular Sofa corner parts

	Article no.	without VAT in SEK*	with VAT in SEK*
<b>Corner element right</b>	<b>210 463 00</b>		
Fabric F40		25.040,00	<b>31.300,00</b>
Fabric F60		26.720,00	<b>33.400,00</b>
Fabric F80		28.000,00	<b>35.000,00</b>
Fabric F100		29.120,00	<b>36.400,00</b>
Fabric F120		30.560,00	<b>38.200,00</b>
Leather L20		36.000,00	<b>45.000,00</b>
Leather L50		49.360,00	<b>61.700,00</b>
<b>Corner element left</b>	<b>210 464 00</b>		
Fabric F40		25.040,00	<b>31.300,00</b>
Fabric F60		26.720,00	<b>33.400,00</b>
Fabric F80		28.000,00	<b>35.000,00</b>
Fabric F100		29.120,00	<b>36.400,00</b>
Fabric F120		30.560,00	<b>38.200,00</b>
Leather L20		36.000,00	<b>45.000,00</b>
Leather L50		49.360,00	<b>61.700,00</b>

## Soft Modular Sofa Ottoman

	Article no.	without VAT in SEK*	with VAT in SEK*
<b>Ottoman</b>	<b>210 467 00</b>		
Fabric F40		12.800,00	<b>16.000,00</b>
Fabric F60		14.000,00	<b>17.500,00</b>
Fabric F80		14.640,00	<b>18.300,00</b>
Fabric F100		15.200,00	<b>19.000,00</b>
Fabric F120		15.840,00	<b>19.800,00</b>
Leather L20		18.880,00	<b>23.600,00</b>
Leather L50		25.040,00	<b>31.300,00</b>

Fabric F40	Fabric F60	Fabric F80	Fabric F100	Fabric F120	Leather L20	Leather L50	Height armrests
. Laser RE . Mello	. Olimpo . Volo	. Cosy 2 . Dumet . Iroko 2 . Linho . Savana . Tress	. Aura . Nubia . Reed	. Credo . Track	. Leather	. Leather Premium F	01 low 02 high

## Soft Modular Sofa

Jasper Morrison, 2016

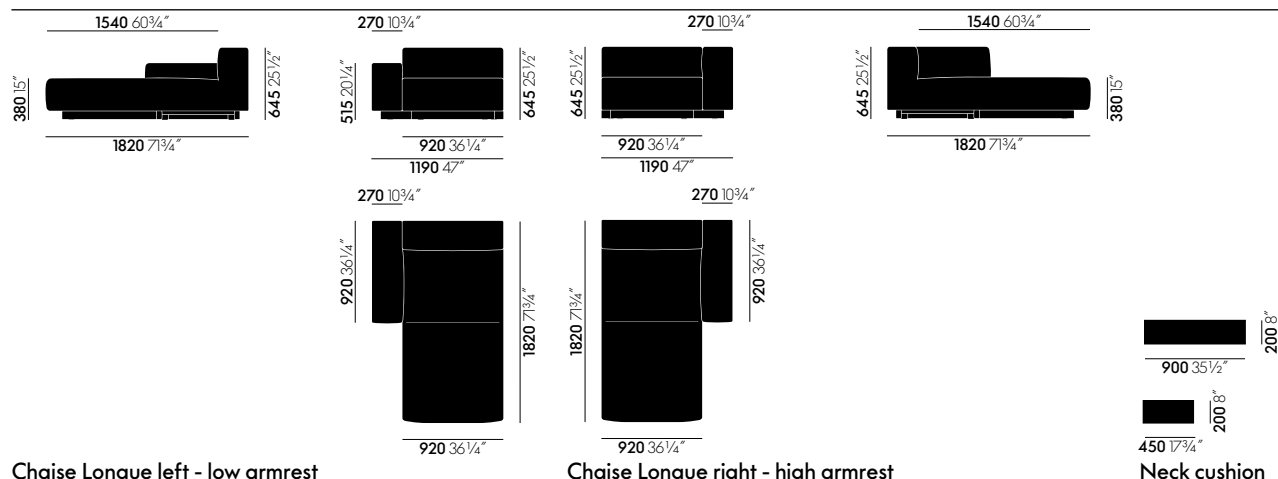

Chaise Longue left - low armrest

Chaise Longue right - high armrest

Neck cushion

All measurements are pursuant to EN 1335-1:2000

More detailed information is found in the chapter 'Explanation of measurements'.

## Soft Modular Sofa Chaises Longues

	Article no.	without VAT in SEK*	with VAT in SEK*
<b>Chaise Longue right</b>	<b>210 465 00</b>		
Fabric F40		31.520,00	<b>39.400,00</b>
Fabric F60		33.520,00	<b>41.900,00</b>
Fabric F80		35.440,00	<b>44.300,00</b>
Fabric F100		37.600,00	<b>47.000,00</b>
Fabric F120		39.600,00	<b>49.500,00</b>
Leather L20		46.240,00	<b>57.800,00</b>
Leather L50		64.560,00	<b>80.700,00</b>
<b>Chaise Longue left</b>	<b>210 466 00</b>		
Fabric F40		31.520,00	<b>39.400,00</b>
Fabric F60		33.520,00	<b>41.900,00</b>
Fabric F80		35.440,00	<b>44.300,00</b>
Fabric F100		37.600,00	<b>47.000,00</b>
Fabric F120		39.600,00	<b>49.500,00</b>
Leather L20		46.240,00	<b>57.800,00</b>
Leather L50		64.560,00	<b>80.700,00</b>

## Soft Modular Sofa neck support cushions

	Article no.	without VAT in SEK*	with VAT in SEK*
<b>Neck cushion, short</b>	<b>210 468 00</b>		
Fabric F40		800,00	<b>1.000,00</b>
Fabric F60		1.040,00	<b>1.300,00</b>
Fabric F80		1.168,00	<b>1.460,00</b>
Fabric F100		1.400,00	<b>1.750,00</b>
Fabric F120		1.520,00	<b>1.900,00</b>
Leather L20		1.760,00	<b>2.200,00</b>
Leather L50		2.840,00	<b>3.550,00</b>
<b>Neck cushion, long</b>	<b>210 469 00</b>		
Fabric F40		1.520,00	<b>1.900,00</b>
Fabric F60		1.760,00	<b>2.200,00</b>
Fabric F80		2.200,00	<b>2.750,00</b>
Fabric F100		2.600,00	<b>3.250,00</b>
Fabric F120		2.840,00	<b>3.550,00</b>
Leather L20		3.400,00	<b>4.250,00</b>
Leather L50		5.280,00	<b>6.600,00</b>

# Soft Modular Sofa

## Jasper Morrison, 2016

vitra.



### Decorative cushions

All measurements are pursuant to EN 1335-1:2000  
More detailed information is found in the chapter 'Explanation of measurements'.

### Soft Modular Sofa cushions

	Article no.	without VAT in SEK*	with VAT in SEK*
<b>Cushion 30 x 40 cm</b>	<b>210 470 00</b>		
Fabric F40		912,00	<b>1.140,00</b>
Fabric F60		1.168,00	<b>1.460,00</b>
Fabric F80		1.280,00	<b>1.600,00</b>
Fabric F100		1.400,00	<b>1.750,00</b>
Fabric F120		1.672,00	<b>2.090,00</b>
Leather L20		1.960,00	<b>2.450,00</b>
Leather L50		2.840,00	<b>3.550,00</b>
<b>Cushion 40 x 40 cm</b>	<b>210 471 00</b>		
Fabric F40		1.040,00	<b>1.300,00</b>
Fabric F60		1.280,00	<b>1.600,00</b>
Fabric F80		1.400,00	<b>1.750,00</b>
Fabric F100		1.520,00	<b>1.900,00</b>
Fabric F120		1.760,00	<b>2.200,00</b>
Leather L20		2.072,00	<b>2.590,00</b>
Leather L50		3.320,00	<b>4.150,00</b>
<b>Cushion 50 x 50 cm</b>	<b>210 472 00</b>		
Fabric F40		1.168,00	<b>1.460,00</b>
Fabric F60		1.400,00	<b>1.750,00</b>
Fabric F80		1.672,00	<b>2.090,00</b>
Fabric F100		1.760,00	<b>2.200,00</b>
Fabric F120		2.072,00	<b>2.590,00</b>
Leather L20		2.400,00	<b>3.000,00</b>
Leather L50		4.040,00	<b>5.050,00</b>

Fabric F40	Fabric F60	Fabric F80	Fabric F100	Fabric F120	Leather L20	Leather L50	Height armrests
. Laser RE . Mello	. Olimpo . Volo	. Cosy 2 . Dumet . Iroko 2 . Linho . Savana . Tress	. Aura . Nubia . Reed	. Credo . Track	. Leather	. Leather Premium F	01 low 02 high

# Suita

Antonio Citterio, 2010/2019

**vitra.**



Suita Sofa 3-Seater, back cushions: Classic

**Characteristics:**

- firm and soft upholstery
- Fabric and leather
- 3-Seater with 2 seat cushions and 2 back cushions



Suita Sofa 3-Seater, back cushions: pointed cushions

**Characteristics:**

- Soft upholstery
- Fabric and leather
- 3-Seater with 2 seat cushions and 5 back cushions



Suita Sofa 3-Seater, tufted

**Characteristics:**

- Soft upholstery
- Fabric, no leather
- 3-Seater with one one-piece seat cushion and 3 back cushions
- Daybed available

# Suita

Antonio Citterio, 2010/2019

## Suita

**Legs:** die-cast aluminium, polished or powder-coated.

**Body:** webbed metal frame with moulded polyurethane foam.

**Classic seat cushions, firm:** polyurethane foam and polyester fibre.

**Classic seat cushions, soft and tufted:** polyurethane foam core and chamber cushion overlay (filled with polyurethane foam lozenges, latex and a mix of goose feathers and down).

**Seat height:** 430 mm (315 mm with applied load, measured in accordance with EN 1335-1:2000).

**Classic back cushions, firm:** chamber cushions filled with polyurethane chips and feathers.

**Classic back cushions, soft:** chamber cushions filled with polyurethane foam cubes and feathers.

**Tufted back cushions:** chamber cushions filled with polyurethane foam cubes and ball fibres.

**Pointed cushions 40 x 40 cm and 40 x 60 cm:** filled with 100% feathers.

**Pointed cushions 60 x 60 cm and 60 x 80 cm:** filled with polyurethane foam lozenges and feathers.

**Bolsters:** filled with polyurethane foam lozenges and feathers.

**Armrest cushions:** latex and siliconised fibres.

**Covers:** removable.

**Glides:** non-slip.

**Head section:** moulded polyurethane foam with metal frame.

**Shelf:** aluminium profile, powder-coated die-cast zinc with linoleum inlay.

**Daybed:** metal frame with wooden panel, polyurethane foam, soft seat cushion.

**Covers:** removable.

**Glides:** non-slip.

**Ottoman, firm:** wooden panel, polyurethane foam, firm seat cushion.

**Ottoman, soft and tufted:** wooden panel, polyurethane foam core and chamber cushion overlay (filled with polyurethane foam lozenges, latex and a mix of goose feathers and down).

**Covers:** removable.

**Glides (for Suita Ottoman and Suita Club Armchair):** glides for carpet or felt glides for hard floors.

**Note:** the designations ‚left‘ and ‚right‘ refer to the perspective when viewing the sofa from the front.

**Note:** ripples and indentations from sitting (pressure marks) and partially visible outlines of the chamber cushions are characteristic of high-quality, soft upholstery in combination with a removable cover and can be more or less pronounced, depending on the selected cover material. To retain the fullness and shape of your sofa, cushions should be regularly shaken and plumped.

**Application:** soft upholstery version recommended for domestic use only.

Fabric F40	Fabric F60	Fabric F80	Fabric F100	Fabric F120	Leather L20	Leather L50	Leather L60
· Laser RE · Mello	· Olimpo · Volo	· Corsaro · Cosy 2 (cross stitch) · Dumet · Iroko 2 · Linho · Savana	· Nubia · Reed	· Credo	· Leather	· Leather Premium F	· Leather Natural F

Base	Tray	Tray inlay
03 polished aluminium 30 basic dark powder-coated (smooth)	30 basic dark powder-coated (smooth)	01 pebble 02 charcoal

# Suita, back cushions Classic

Antonio Citterio, 2010/2019



## Suita Sofa, back cushion Classic

with VAT in SEK\*

	F40 Laser RE Mello	F60 Olimpo Volo	F80 Corsaro Cosy 2 Dumet Iroko 2 Linho Savana	F100 Nubia Reed	F120 Credo	L20 Leather	L60 Leather Premium F	L60 Leather Natural F
<b>Suita Sofa 2-Seater</b>	<b>210 593 00</b>							
Upholstery firm	52.200,00	56.100,00	59.700,00	63.600,00	67.400,00	79.100,00	103.800,00	135.900,00
<b>Surcharges</b>								
Upholstery soft	4.250,00	4.250,00	4.250,00	4.250,00	4.250,00	4.250,00	4.250,00	4.250,00
+ Head Section	13.700,00	14.800,00	16.000,00	17.200,00	18.300,00	21.900,00	29.300,00	40.400,00
+ Tray	14.900,00	14.900,00	14.900,00	14.900,00	14.900,00	14.900,00	14.900,00	14.900,00

## Suita Sofa 2-Seater open

**210 594 00**

Upholstery firm	50.700,00	54.000,00	57.300,00	60.800,00	64.100,00	77.600,00	99.100,00	127.400,00
<b>Surcharges</b>								
Upholstery soft	4.250,00	4.250,00	4.250,00	4.250,00	4.250,00	4.250,00	4.250,00	4.250,00
+ Tray	14.900,00	14.900,00	14.900,00	14.900,00	14.900,00	14.900,00	14.900,00	14.900,00

## Suita Sofa 3-Seater

**210 595 00**

Upholstery firm	64.800,00	69.100,00	73.700,00	77.900,00	82.400,00	94.400,00	124.900,00	165.600,00
<b>Surcharges</b>								
Upholstery soft	5.250,00	5.250,00	5.250,00	5.250,00	5.250,00	5.250,00	5.250,00	5.250,00
+ Head Section	14.600,00	16.000,00	17.500,00	18.900,00	20.300,00	23.000,00	31.300,00	42.800,00
+ Tray	17.000,00	17.000,00	17.000,00	17.000,00	17.000,00	17.000,00	17.000,00	17.000,00

## Suita Sofa 3-Seater open

**210 596 00**

Upholstery firm	63.400,00	67.700,00	71.700,00	76.000,00	80.200,00	93.000,00	120.000,00	155.700,00
<b>Surcharges</b>								
Upholstery soft	5.250,00	5.250,00	5.250,00	5.250,00	5.250,00	5.250,00	5.250,00	5.250,00
+ Tray	17.000,00	17.000,00	17.000,00	17.000,00	17.000,00	17.000,00	17.000,00	17.000,00

# Suita, back cushions Classic

Antonio Citterio, 2010/2019

## Suita Sofa, back cushion Classic

with VAT in SEK\*

	F40 Laser RE Mello	F60 Olimpo Volo	F80 Corsaro Cosy 2 Dumet Iroko 2 Linho Savana	F100 Nubia Reed	F120 Credo	L20 Leather	L50 Leather Premium F	L60 Leather Natural F
--	--------------------------	-----------------------	---	-----------------------	---------------	----------------	-----------------------------	-----------------------------

### Suita Sofa Chaise Longue small 210 597 00

Upholstery firm	47.800,00	50.600,00	53.700,00	56.800,00	59.800,00	72.000,00	94.100,00	123.000,00
<b>Surcharges</b>								
Upholstery soft	4.250,00	4.250,00	4.250,00	4.250,00	4.250,00	4.250,00	4.250,00	4.250,00
+ Head Section	9.000,00	9.550,00	10.000,00	10.700,00	11.200,00	12.300,00	16.400,00	22.300,00

### Suita Sofa Chaise Longue large 210 598 00

Upholstery firm	70.900,00	74.700,00	78.600,00	82.700,00	86.600,00	95.600,00	123.800,00	160.800,00
<b>Surcharges</b>								
Upholstery soft	5.250,00	5.250,00	5.250,00	5.250,00	5.250,00	5.250,00	5.250,00	5.250,00
+ Head Section	9.000,00	9.550,00	10.000,00	10.700,00	11.200,00	12.300,00	16.400,00	22.300,00

### Suita Ottoman 210 599 00

Upholstery firm	19.600,00	20.500,00	21.500,00	22.700,00	23.500,00	26.600,00	35.600,00	48.100,00
-----------------	-----------	-----------	-----------	-----------	-----------	-----------	-----------	-----------

### Suita Cushions

Cushion for head section	210 615 00	1.130,00	1.280,00	1.470,00	1.640,00	1.790,00	2.350,00	3.350,00	4.750,00
Armrest cushion 59 x 15 x 27 cm	210 600 00	2.550,00	3.190,00	3.890,00	4.650,00	5.290,00	5.390,00	8.190,00	12.000,00
Armrest cushion 59x15x27 cm (set of 2)	210 648 00	4.250,00	4.900,00	5.600,00	6.450,00	7.100,00	10.900,00	16.200,00	23.900,00
Roll cushions 54 x Ø16 cm	210 616 00	1.430,00	1.680,00	1.910,00	2.150,00	2.450,00	2.750,00	3.850,00	5.390,00

# Suita, back cushions Classic

Antonio Citterio, 2010/2019

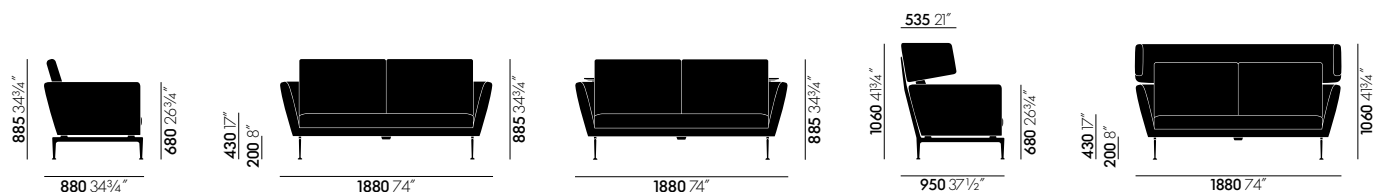

Suita Sofa 2-Seater

Suita Sofa 2-Seater  
with tray

Suita Sofa 2-Seater with head section

## Suita Sofa 2-Seater, classic

	Article no.	without VAT in SEK*	with VAT in SEK*
		<b>210 593 00</b>	
Fabric F40		41.760,00	<b>52.200,00</b>
Fabric F60		44.880,00	<b>56.100,00</b>
Fabric F80		47.760,00	<b>59.700,00</b>
Fabric F100		50.880,00	<b>63.600,00</b>
Fabric F120		53.920,00	<b>67.400,00</b>
Leather L20		63.280,00	<b>79.100,00</b>
Leather L50		83.040,00	<b>103.800,00</b>
Leather L60		108.720,00	<b>135.900,00</b>
<b>Surcharges upholstery</b>			
Comfort soft	02	3.400,00	<b>4.250,00</b>
<b>Surcharges shelf</b>			
basic dark		11.920,00	<b>14.900,00</b>
<b>Surcharges head section</b>			
Fabric F40		10.960,00	<b>13.700,00</b>
Fabric F60		11.840,00	<b>14.800,00</b>
Fabric F80		12.800,00	<b>16.000,00</b>
Fabric F100		13.760,00	<b>17.200,00</b>
Fabric F120		14.640,00	<b>18.300,00</b>
Leather L20		17.520,00	<b>21.900,00</b>
Leather L50		23.440,00	<b>29.300,00</b>
Leather L60		32.320,00	<b>40.400,00</b>

Fabric F40	Fabric F60	Fabric F80	Fabric F100	Fabric F120	Leather L20	Leather L50	Leather L60
· Laser RE · Mello	· Olimpo · Volo	· Corsaro · Cosy 2 (cross stitch) · Dumet · Iroko 2 · Linho · Savana	· Nubia · Reed	· Credo	· Leather	· Leather Premium F	· Leather Natural F

Base	Tray	Tray inlay
03 polished aluminium 30 basic dark powder-coated (smooth)	30 basic dark powder-coated (smooth)	01 pebble 02 charcoal



# Suita, back cushions Classic

Antonio Citterio, 2010/2019

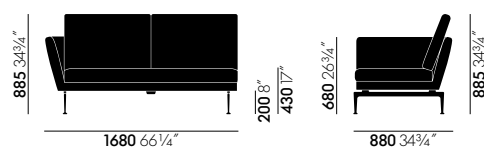

Suita Sofa 2-Seater, open, armrest left

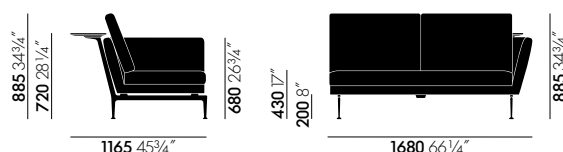

Suita Sofa 2-Seater, open, armrest right, with tray

## Suita Sofa 2-Seater open, classic

	Article no.	without VAT in SEK*	with VAT in SEK*
	<b>210 594 00</b>		
Fabric F40		40.560,00	<b>50.700,00</b>
Fabric F60		43.200,00	<b>54.000,00</b>
Fabric F80		45.840,00	<b>57.300,00</b>
Fabric F100		48.640,00	<b>60.800,00</b>
Fabric F120		51.280,00	<b>64.100,00</b>
Leather L20		62.080,00	<b>77.600,00</b>
Leather L50		79.280,00	<b>99.100,00</b>
Leather L60		101.920,00	<b>127.400,00</b>
<b>Surcharges upholstery</b>			
Comfort soft	02	3.400,00	<b>4.250,00</b>
<b>Surcharges tray</b>			
basic dark		11.920,00	<b>14.900,00</b>

Fabric F40	Fabric F60	Fabric F80	Fabric F100	Fabric F120	Leather L20	Leather L50	Leather L60
· Laser RE · Mello	· Olimpo · Volo	· Corsaro · Cosy 2 (cross stitch) · Dumet · Ireko 2 · Linho · Savana	· Nubia · Reed	· Credo	· Leather	· Leather Premium F	· Leather Natural F

Base	Tray	Tray inlay
03 polished aluminium 30 basic dark powder-coated (smooth)	30 basic dark powder-coated (smooth)	01 pebble 02 charcoal

# Suita, back cushions Classic

Antonio Citterio, 2010/2019

vitra.

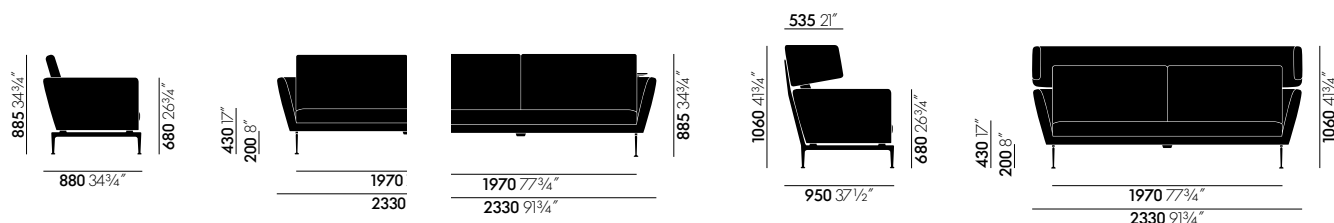

Suita Sofa 3-Seater

Suita Sofa 3-Seater with tray

Suita Sofa 3-Seater with head section

## Suita Sofa 3-seater, classic

	Article no.	without VAT in SEK*	with VAT in SEK*
		<b>210 595 00</b>	
Fabric F40		51.840,00	<b>64.800,00</b>
Fabric F60		55.280,00	<b>69.100,00</b>
Fabric F80		58.960,00	<b>73.700,00</b>
Fabric F100		62.320,00	<b>77.900,00</b>
Fabric F120		65.920,00	<b>82.400,00</b>
Leather L20		75.520,00	<b>94.400,00</b>
Leather L50		99.920,00	<b>124.900,00</b>
Leather L60		132.480,00	<b>165.600,00</b>
<b>Surcharges upholstery</b>			
Comfort soft	02	4.200,00	<b>5.250,00</b>
<b>Surcharges tray</b>			
basic dark		13.600,00	<b>17.000,00</b>
<b>Surcharges header section</b>			
Fabric F40		11.680,00	<b>14.600,00</b>
Fabric F60		12.800,00	<b>16.000,00</b>
Fabric F80		14.000,00	<b>17.500,00</b>
Fabric F100		15.120,00	<b>18.900,00</b>
Fabric F120		16.240,00	<b>20.300,00</b>
Leather L20		18.400,00	<b>23.000,00</b>
Leather L50		25.040,00	<b>31.300,00</b>
Leather L60		34.240,00	<b>42.800,00</b>

Fabric F40	Fabric F60	Fabric F80	Fabric F100	Fabric F120	Leather L20	Leather L50	Leather L60
· Laser RE · Mello	· Olimpo · Volo	· Corsaro · Cosy 2 (cross stitch) · Dumet · Iroko 2 · Linho · Savana	· Nubia · Reed	· Credo	· Leather	· Leather Premium F	· Leather Natural F

Base	Tray	Tray inlay
03 polished aluminium 30 basic dark powder-coated (smooth)	30 basic dark powder-coated (smooth)	01 pebble 02 charcoal

# Suita, back cushions Classic

Antonio Citterio, 2010/2019

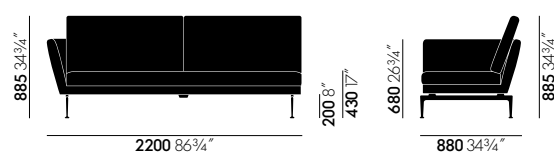

Suita Sofa 3-Seater, open, armrest left

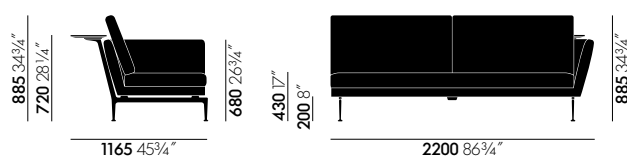

Suita Sofa 3-Seater, open, armrest right, with tray

## Suita Sofa 3-Seater open, classic

	Article no.	without VAT in SEK*	with VAT in SEK*
			<b>210 596 00</b>
Fabric F40		50.720,00	<b>63.400,00</b>
Fabric F60		54.160,00	<b>67.700,00</b>
Fabric F80		57.360,00	<b>71.700,00</b>
Fabric F100		60.800,00	<b>76.000,00</b>
Fabric F120		64.160,00	<b>80.200,00</b>
Leather L20		74.400,00	<b>93.000,00</b>
Leather L50		96.000,00	<b>120.000,00</b>
Leather L60		124.560,00	<b>155.700,00</b>
<b>Surcharges upholstery</b>			
Comfort soft	02	4.200,00	<b>5.250,00</b>
<b>Surcharges tray</b>			
basic dark		13.600,00	<b>17.000,00</b>

Fabric F40	Fabric F60	Fabric F80	Fabric F100	Fabric F120	Leather L20	Leather L50	Leather L60
· Laser RE · Mello	· Olimpo · Volo	· Corsaro · Cosy 2 (cross stitch) · Dumet · Iroko 2 · Linho · Savana	· Nubia · Reed	· Credo	· Leather	· Leather Premium F	· Leather Natural F

Base	Tray	Tray inlay
03 polished aluminium 30 basic dark powder-coated (smooth)	30 basic dark powder-coated (smooth)	01 pebble 02 charcoal

# Suita, back cushions Classic

Antonio Citterio, 2010/2019

**vitra.**



Suita Chaise Longue small, left

Suita Chaise Longue small, right, with head section

## Suita Chaise Longue small, classic

	Article no.	without VAT in SEK*	with VAT in SEK*
	<b>210 597 00</b>		
Fabric F40		38.240,00	<b>47.800,00</b>
Fabric F60		40.480,00	<b>50.600,00</b>
Fabric F80		42.960,00	<b>53.700,00</b>
Fabric F100		45.440,00	<b>56.800,00</b>
Fabric F120		47.840,00	<b>59.800,00</b>
Leather L20		57.600,00	<b>72.000,00</b>
Leather L50		75.280,00	<b>94.100,00</b>
Leather L60		98.400,00	<b>123.000,00</b>
<b>Surcharges upholstery</b>			
Comfort soft	02	3.400,00	<b>4.250,00</b>
<b>Surcharges header section</b>			
Fabric F40		7.200,00	<b>9.000,00</b>
Fabric F60		7.640,00	<b>9.550,00</b>
Fabric F80		8.000,00	<b>10.000,00</b>
Fabric F100		8.560,00	<b>10.700,00</b>
Fabric F120		8.960,00	<b>11.200,00</b>
Leather L20		9.840,00	<b>12.300,00</b>
Leather L50		13.120,00	<b>16.400,00</b>
Leather L60		17.840,00	<b>22.300,00</b>

Fabric F40	Fabric F60	Fabric F80	Fabric F100	Fabric F120	Leather L20	Leather L50	Leather L60
· Laser RE · Mello	· Olimpo · Volo	· Corsaro · Cosy 2 (cross stitch) · Dumet · Iroko 2 · Linho · Savana	· Nubia · Reed	· Credo	· Leather	· Leather Premium F	· Leather Natural F

## Base

- 03 polished aluminium
- 30 basic dark powder-coated (smooth)

# Suita, back cushions Classic

Antonio Citterio, 2010/2019

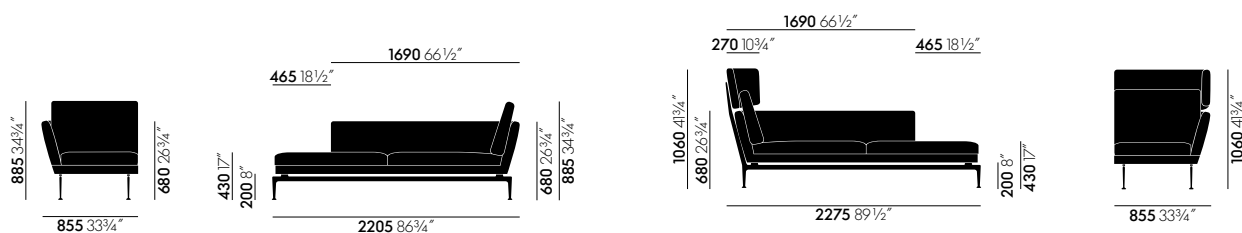

Suita Chaise Longue large, left

Suita Chaise Longue large, right, with head section

## Suita Chaise Longue large, classic

	Article no.	without VAT in SEK*	with VAT in SEK*
	<b>210 598 00</b>		
Fabric F40		56.720,00	<b>70.900,00</b>
Fabric F60		59.760,00	<b>74.700,00</b>
Fabric F80		62.880,00	<b>78.600,00</b>
Fabric F100		66.160,00	<b>82.700,00</b>
Fabric F120		69.280,00	<b>86.600,00</b>
Leather L20		76.480,00	<b>95.600,00</b>
Leather L50		99.040,00	<b>123.800,00</b>
Leather L60		128.640,00	<b>160.800,00</b>
<b>Surcharges upholstery</b>			
Comfort soft	02	4.200,00	<b>5.250,00</b>
<b>Surcharges header section</b>			
Fabric F40		7.200,00	<b>9.000,00</b>
Fabric F60		7.640,00	<b>9.550,00</b>
Fabric F80		8.000,00	<b>10.000,00</b>
Fabric F100		8.560,00	<b>10.700,00</b>
Fabric F120		8.960,00	<b>11.200,00</b>
Leather L20		9.840,00	<b>12.300,00</b>
Leather L50		13.120,00	<b>16.400,00</b>
Leather L60		17.840,00	<b>22.300,00</b>

Fabric F40	Fabric F60	Fabric F80	Fabric F100	Fabric F120	Leather L20	Leather L50	Leather L60
· Laser RE · Mello	· Olimpo · Volo	· Corsaro · Cosy 2 (cross stitch) · Dumet · Iroko 2 · Linho · Savana	· Nubia · Reed	· Credo	· Leather	· Leather Premium F	· Leather Natural F

## Base

- 03 polished aluminium
- 30 basic dark powder-coated (smooth)

# Suita, back cushions Classic

Antonio Citterio, 2010/2019

**vitra.**



## Suita Ottoman

Suita Ottoman	Article no.	without VAT in SEK*	with VAT in SEK*
	<b>210 599 00</b>		
Fabric F40		15.680,00	<b>19.600,00</b>
Fabric F60		16.400,00	<b>20.500,00</b>
Fabric F80		17.200,00	<b>21.500,00</b>
Fabric F100		18.160,00	<b>22.700,00</b>
Fabric F120		18.800,00	<b>23.500,00</b>
Leather L20		21.280,00	<b>26.600,00</b>
Leather L50		28.480,00	<b>35.600,00</b>
Leather L60		38.480,00	<b>48.100,00</b>

Fabric F40	Fabric F60	Fabric F80	Fabric F100	Fabric F120	Leather L20	Leather L50	Leather L60
· Laser RE · Mello	· Olimpo · Volo	· Corsaro · Cosy 2 (cross stitch) · Dumet · Ireko 2 · Linho · Savana	· Nubia · Reed	· Credo	· Leather	· Leather Premium F	· Leather Natural F

Base	Glides, Ottoman
03 polished aluminium 30 basic dark powder-coated (smooth)	04 glides for carpet 05 felt glides for hard floor

# Suita, back cushions: pointed

Antonio Citterio, 2010/2019



## Suita Sofa, back pointed cushion

with VAT in SEK\*

	F40 Laser RE Mello	F60 Olimpo Volo	F80 Corsaro Cosy 2 Dumet Iroko 2 Linho Savana	F100 Nubia Reed	F120 Credo	L20 Leather	L50 Leather Premium F	L60 Leather Natural F
--	--------------------------	-----------------------	---	-----------------------	---------------	----------------	-----------------------------	-----------------------------

### Suita Sofa 2-Seater 210 609 00

Upholstery soft	57.800,00	61.600,00	65.400,00	69.100,00	73.100,00	84.200,00	108.800,00	141.000,00
-----------------	-----------	-----------	-----------	-----------	-----------	-----------	------------	------------

#### Surcharges

+ Head Section	13.700,00	14.800,00	16.000,00	17.200,00	18.300,00	21.900,00	29.300,00	40.400,00
+ Tray	14.900,00	14.900,00	14.900,00	14.900,00	14.900,00	14.900,00	14.900,00	14.900,00

### Suita Sofa 2-Seater open 210 610 00

Upholstery soft	56.600,00	59.900,00	63.400,00	66.700,00	70.400,00	83.300,00	104.700,00	133.000,00
-----------------	-----------	-----------	-----------	-----------	-----------	-----------	------------	------------

#### Surcharges

+ Tray	14.900,00	14.900,00	14.900,00	14.900,00	14.900,00	14.900,00	14.900,00	14.900,00
--------	-----------	-----------	-----------	-----------	-----------	-----------	-----------	-----------

### Suita Sofa 3-Seater 210 611 00

Upholstery soft	71.300,00	75.700,00	80.200,00	84.400,00	89.000,00	100.700,00	131.300,00	171.700,00
-----------------	-----------	-----------	-----------	-----------	-----------	------------	------------	------------

#### Surcharges

+ Head Section	14.600,00	16.000,00	17.500,00	18.900,00	20.300,00	23.000,00	31.300,00	42.800,00
+ Tray	17.000,00	17.000,00	17.000,00	17.000,00	17.000,00	17.000,00	17.000,00	17.000,00

### Suita Sofa 3-Seater open 210 612 00

Upholstery soft	69.600,00	74.100,00	78.200,00	82.300,00	86.600,00	99.000,00	126.000,00	161.800,00
-----------------	-----------	-----------	-----------	-----------	-----------	-----------	------------	------------

#### Surcharges

+ Tray	17.000,00	17.000,00	17.000,00	17.000,00	17.000,00	17.000,00	17.000,00	17.000,00
--------	-----------	-----------	-----------	-----------	-----------	-----------	-----------	-----------

# Suita, back cushions: pointed

Antonio Citterio, 2010/2019

## Suita Sofa, back pointed cushion

with VAT in SEK\*

F40	F60	F80	F100	F120	L20	L50	L60
Laser RE Mello	Olimpo Volo	Corsaro Cosy 2 Dumet Iroko 2 Linho Savana	Nubia Reed	Credo	Leather	Leather Premium F	Leather Natural F

### Suita Sofa Chaise Longue small 210 613 00

Upholstery soft	52.200,00	55.400,00	58.300,00	61.400,00	64.600,00	76.800,00	98.600,00	127.700,00
<b>Surcharges</b>								
+ Head Section	9.000,00	9.550,00	10.000,00	10.700,00	11.200,00	12.300,00	16.400,00	22.300,00

### Suita Sofa Chaise Longue large 210 614 00

Upholstery soft	77.700,00	81.500,00	85.400,00	89.300,00	93.100,00	101.800,00	129.900,00	166.900,00
<b>Surcharges</b>								
+ Head Section	9.000,00	9.550,00	10.000,00	10.700,00	11.200,00	12.300,00	16.400,00	22.300,00

### Suita Ottoman 210 599 00

Upholstery firm	19.600,00	20.500,00	21.500,00	22.700,00	23.500,00	26.600,00	35.600,00	48.100,00
-----------------	-----------	-----------	-----------	-----------	-----------	-----------	-----------	-----------

## Suita Cushions

Cushion for head section	210 615 00	1.130,00	1.280,00	1.470,00	1.640,00	1.790,00	2.350,00	3.350,00	4.750,00
Armrest cushion 59 x 15 x 27 cm	210 600 00	2.550,00	3.190,00	3.890,00	4.650,00	5.290,00	5.390,00	8.190,00	12.000,00
Armrest cushion 59x15x27 cm (set of 2)	210 648 00	4.250,00	4.900,00	5.600,00	6.450,00	7.100,00	10.900,00	16.200,00	23.900,00
Roll cushions 54 x Ø16 cm	210 616 00	1.430,00	1.680,00	1.910,00	2.150,00	2.450,00	2.750,00	3.850,00	5.390,00
Pointed cushion 40 x 40 cm	210 617 00	930,00	1.130,00	1.330,00	1.530,00	1.740,00	2.200,00	3.250,00	4.590,00
Pointed cushion 40 x 60 cm	210 618 00	1.570,00	1.840,00	2.150,00	2.490,00	2.790,00	3.790,00	5.050,00	6.750,00
Pointed cushion 60 x 60 cm	210 619 00	1.890,00	2.200,00	2.550,00	2.790,00	3.150,00	4.590,00	5.790,00	7.490,00
Pointed cushion 80 x 60 cm	210 620 00	2.790,00	3.290,00	3.790,00	4.390,00	4.790,00	6.450,00	7.890,00	10.000,00



# Suita, back cushions: pointed

Antonio Citterio, 2010/2019

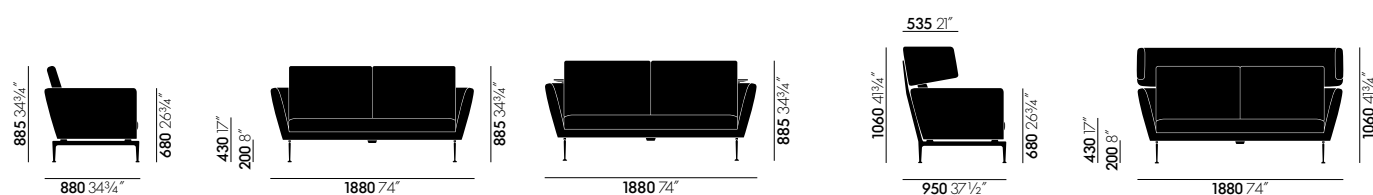

Suita Sofa 2-Seater

Suita Sofa 2-Seater  
with tray

Suita Sofa 2-Seater with head section

## Suita Sofa 2-Seater, pointed cushions

	Article no.	without VAT in SEK*	with VAT in SEK*
	<b>210 609 00</b>		
Fabric F40		46.240,00	<b>57.800,00</b>
Fabric F60		49.280,00	<b>61.600,00</b>
Fabric F80		52.320,00	<b>65.400,00</b>
Fabric F100		55.280,00	<b>69.100,00</b>
Fabric F120		58.480,00	<b>73.100,00</b>
Leather L20		67.360,00	<b>84.200,00</b>
Leather L50		87.040,00	<b>108.800,00</b>
Leather L60		112.800,00	<b>141.000,00</b>
<b>Surcharges tray</b>			
basic dark		11.920,00	<b>14.900,00</b>
<b>Surcharges header section</b>			
Fabric F40		10.960,00	<b>13.700,00</b>
Fabric F60		11.840,00	<b>14.800,00</b>
Fabric F80		12.800,00	<b>16.000,00</b>
Fabric F100		13.760,00	<b>17.200,00</b>
Fabric F120		14.640,00	<b>18.300,00</b>
Leather L20		17.520,00	<b>21.900,00</b>
Leather L50		23.440,00	<b>29.300,00</b>
Leather L60		32.320,00	<b>40.400,00</b>

Fabric F40	Fabric F60	Fabric F80	Fabric F100	Fabric F120	Leather L20	Leather L50	Leather L60
· Laser RE · Mello	· Olimpo · Volo	· Corsaro · Cosy 2 (cross stitch) · Dumet · Iroko 2 · Linho · Savana	· Nubia · Reed	· Credo	· Leather	· Leather Premium F	· Leather Natural F

Base	Tray	Tray inlay
03 polished aluminium 30 basic dark powder-coated (smooth)	30 basic dark powder-coated (smooth)	01 pebble 02 charcoal

# Suita, back cushions: pointed

Antonio Citterio, 2010/2019

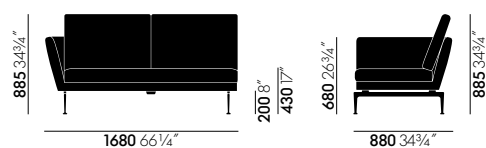

Suita Sofa 2-Seater, open, armrest left

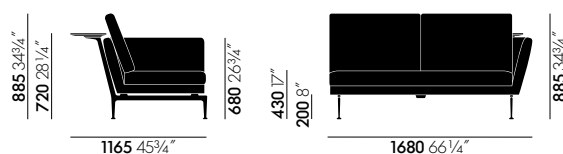

Suita Sofa 2-Seater, open, armrest right, with tray

## Suita Sofa 2-Seater open, pointed cushions

	Article no.	without VAT in SEK*	with VAT in SEK*
	<b>210 610 00</b>		
Fabric F40		45.280,00	<b>56.600,00</b>
Fabric F60		47.920,00	<b>59.900,00</b>
Fabric F80		50.720,00	<b>63.400,00</b>
Fabric F100		53.360,00	<b>66.700,00</b>
Fabric F120		56.320,00	<b>70.400,00</b>
Leather L20		66.640,00	<b>83.300,00</b>
Leather L50		83.760,00	<b>104.700,00</b>
Leather L60		106.400,00	<b>133.000,00</b>
<b>Surcharges tray</b>			
basic dark		11.920,00	<b>14.900,00</b>

Fabric F40	Fabric F60	Fabric F80	Fabric F100	Fabric F120	Leather L20	Leather L50	Leather L60
· Laser RE · Mello	· Olimpo · Volo	· Corsaro · Cosy 2 (cross stitch) · Dumet · Ireko 2 · Linho · Savana	· Nubia · Reed	· Credo	· Leather	· Leather Premium F	· Leather Natural F

Base	Tray	Tray inlay
03 polished aluminium 30 basic dark powder-coated (smooth)	30 basic dark powder-coated (smooth)	01 pebble 02 charcoal

# Suita, back cushions: pointed

Antonio Citterio, 2010/2019

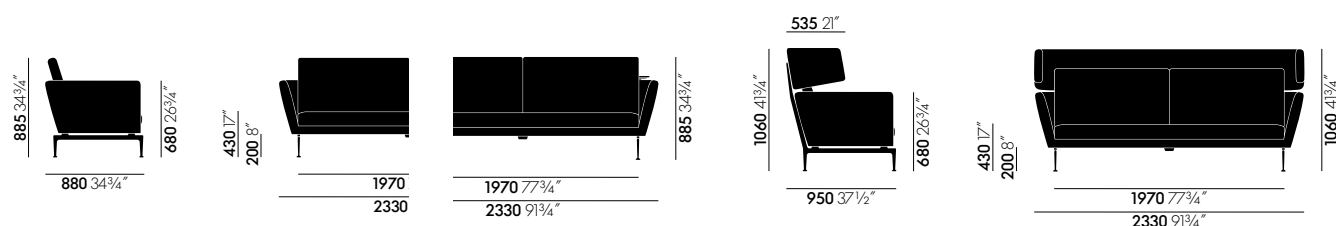

Suita Sofa 3-Seater

Suita Sofa 3-Seater with tray

Suita Sofa 3-Seater with head section

## Suita Sofa 3-Seater, pointed cushions

	Article no.	without VAT in SEK*	with VAT in SEK*
	<b>210 611 00</b>		
Fabric F40		57.040,00	<b>71.300,00</b>
Fabric F60		60.560,00	<b>75.700,00</b>
Fabric F80		64.160,00	<b>80.200,00</b>
Fabric F100		67.520,00	<b>84.400,00</b>
Fabric F120		71.200,00	<b>89.000,00</b>
Leather L20		80.560,00	<b>100.700,00</b>
Leather L50		105.040,00	<b>131.300,00</b>
Leather L60		137.360,00	<b>171.700,00</b>
<b>Surcharges tray</b>			
basic dark		13.600,00	<b>17.000,00</b>
<b>Surcharges header section</b>			
Fabric F40		11.680,00	<b>14.600,00</b>
Fabric F60		12.800,00	<b>16.000,00</b>
Fabric F80		14.000,00	<b>17.500,00</b>
Fabric F100		15.120,00	<b>18.900,00</b>
Fabric F120		16.240,00	<b>20.300,00</b>
Leather L20		18.400,00	<b>23.000,00</b>
Leather L50		25.040,00	<b>31.300,00</b>
Leather L60		34.240,00	<b>42.800,00</b>

Fabric F40	Fabric F60	Fabric F80	Fabric F100	Fabric F120	Leather L20	Leather L50	Leather L60
· Laser RE · Mello	· Olimpo · Volo	· Corsaro · Cosy 2 (cross stitch) · Dumet · Iroko 2 · Linho · Savana	· Nubia · Reed	· Credo	· Leather	· Leather Premium F	· Leather Natural F

Base	Tray	Tray inlay
03 polished aluminium 30 basic dark powder-coated (smooth)	30 basic dark powder-coated (smooth)	01 pebble 02 charcoal

# Suita, back cushions: pointed

Antonio Citterio, 2010/2019

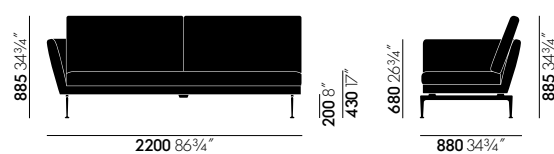

Suita Sofa 3-Seater, open, armrest left

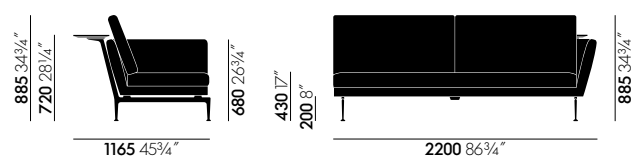

Suita Sofa 3-Seater, open, armrest right, with tray

## Suita Sofa 3-Seater open, pointed cushions

	Article no.	without VAT in SEK*	with VAT in SEK*
	<b>210 612 00</b>		
Fabric F40		55.680,00	<b>69.600,00</b>
Fabric F60		59.280,00	<b>74.100,00</b>
Fabric F80		62.560,00	<b>78.200,00</b>
Fabric F100		65.840,00	<b>82.300,00</b>
Fabric F120		69.280,00	<b>86.600,00</b>
Leather L20		79.200,00	<b>99.000,00</b>
Leather L50		100.800,00	<b>126.000,00</b>
Leather L60		129.440,00	<b>161.800,00</b>
<b>Surcharges tray</b>			
basic dark		13.600,00	<b>17.000,00</b>

Fabric F40	Fabric F60	Fabric F80	Fabric F100	Fabric F120	Leather L20	Leather L50	Leather L60
· Laser RE	· Olimpo	· Corsaro	· Nubia	· Credo	· Leather	· Leather Premium F	· Leather Natural F
· Mello	· Volo	· Cosy 2 (cross stitch)	· Reed				
		· Dumet					
		· Iroko 2					
		· Linho					
		· Savana					

Base	Tray	Tray inlay
03 polished aluminium	30 basic dark powder-coated (smooth)	01 pebble
30 basic dark powder-coated (smooth)		02 charcoal

# Suita, back cushions: pointed

Antonio Citterio, 2010/2019

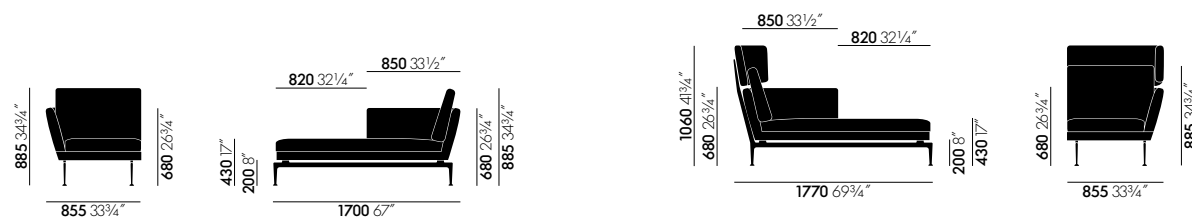

Suita Chaise Longue small, left

Suita Chaise Longue small, right, with head section

## Suita Chaise Longue small, pointed cushions

	Article no.	without VAT in SEK*	with VAT in SEK*
	<b>210 613 00</b>		
Fabric F40		41.760,00	<b>52.200,00</b>
Fabric F60		44.320,00	<b>55.400,00</b>
Fabric F80		46.640,00	<b>58.300,00</b>
Fabric F100		49.120,00	<b>61.400,00</b>
Fabric F120		51.680,00	<b>64.600,00</b>
Leather L20		61.440,00	<b>76.800,00</b>
Leather L50		78.880,00	<b>98.600,00</b>
Leather L60		102.160,00	<b>127.700,00</b>
<b>Surcharges header section</b>			
Fabric F40		7.200,00	<b>9.000,00</b>
Fabric F60		7.640,00	<b>9.550,00</b>
Fabric F80		8.000,00	<b>10.000,00</b>
Fabric F100		8.560,00	<b>10.700,00</b>
Fabric F120		8.960,00	<b>11.200,00</b>
Leather L20		9.840,00	<b>12.300,00</b>
Leather L50		13.120,00	<b>16.400,00</b>
Leather L60		17.840,00	<b>22.300,00</b>

Fabric F40	Fabric F60	Fabric F80	Fabric F100	Fabric F120	Leather L20	Leather L50	Leather L60
· Laser RE · Mello	· Olimpo · Volo	· Corsaro · Cosy 2 (cross stitch) · Dumet · Iroko 2 · Linho · Savana	· Nubia · Reed	· Credo	· Leather	· Leather Premium F	· Leather Natural F

## Base

- 03 polished aluminium
- 30 basic dark powder-coated (smooth)

# Suita, back cushions: pointed

Antonio Citterio, 2010/2019

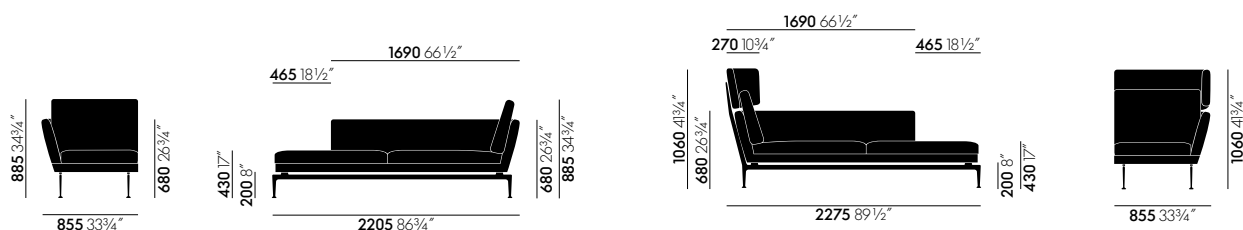

Suita Chaise Longue large, left

Suita Chaise Longue large, right, with head section

## Suita Chaise Longue large, pointed cushions

	Article no.	without VAT in SEK*	with VAT in SEK*
		<b>210 614 00</b>	
Fabric F40		62.160,00	<b>77.700,00</b>
Fabric F60		65.200,00	<b>81.500,00</b>
Fabric F80		68.320,00	<b>85.400,00</b>
Fabric F100		71.440,00	<b>89.300,00</b>
Fabric F120		74.480,00	<b>93.100,00</b>
Leather L20		81.440,00	<b>101.800,00</b>
Leather L50		103.920,00	<b>129.900,00</b>
Leather L60		133.520,00	<b>166.900,00</b>

## Surcharges header section

Fabric F40	7.200,00	<b>9.000,00</b>
Fabric F60	7.640,00	<b>9.550,00</b>
Fabric F80	8.000,00	<b>10.000,00</b>
Fabric F100	8.560,00	<b>10.700,00</b>
Fabric F120	8.960,00	<b>11.200,00</b>
Leather L20	9.840,00	<b>12.300,00</b>
Leather L50	13.120,00	<b>16.400,00</b>
Leather L60	17.840,00	<b>22.300,00</b>

Fabric F40	Fabric F60	Fabric F80	Fabric F100	Fabric F120	Leather L20	Leather L50	Leather L60
· Laser RE · Mello	· Olimpo · Volo	· Corsaro · Cosy 2 (cross stitch) · Dumet · Iroko 2 · Linho · Savana	· Nubia · Reed	· Credo	· Leather	· Leather Premium F	· Leather Natural F

## Base

03 polished aluminium  
30 basic dark powder-coated (smooth)

# Suita, back cushions: pointed

Antonio Citterio, 2010/2019



## Suita Ottoman

### Suita Ottoman

	Article no.	without VAT in SEK*	with VAT in SEK*
	<b>210 599 00</b>		
Fabric F40		15.680,00	<b>19.600,00</b>
Fabric F60		16.400,00	<b>20.500,00</b>
Fabric F80		17.200,00	<b>21.500,00</b>
Fabric F100		18.160,00	<b>22.700,00</b>
Fabric F120		18.800,00	<b>23.500,00</b>
Leather L20		21.280,00	<b>26.600,00</b>
Leather L50		28.480,00	<b>35.600,00</b>
Leather L60		38.480,00	<b>48.100,00</b>

Fabric F40	Fabric F60	Fabric F80	Fabric F100	Fabric F120	Leather L20	Leather L50	Leather L60
· Laser RE · Mello	· Olimpo · Volo	· Corsaro · Cosy 2 (cross stitch) · Dumet · Iroko 2 · Linho · Savana	· Nubia · Reed	· Credo	· Leather	· Leather Premium F	· Leather Natural F

#### Base

03 polished aluminium  
30 basic dark powder-coated (smooth)

#### Glides, Ottoman

04 glides for carpet  
05 felt glides for hard floor

# Suita cushions

Antonio Citterio, 2010/2019

**vitra.**



## Pointed Cushion

	Article no.	without VAT in SEK*	with VAT in SEK*
<b>40 x 40 cm</b>	<b>210 617 00</b>		
Fabric F40		744,00	<b>930,00</b>
Fabric F60		904,00	<b>1.130,00</b>
Fabric F80		1.064,00	<b>1.330,00</b>
Fabric F100		1.224,00	<b>1.530,00</b>
Fabric F120		1.392,00	<b>1.740,00</b>
Leather L20		1.760,00	<b>2.200,00</b>
Leather L50		2.600,00	<b>3.250,00</b>
Leather L60		3.672,00	<b>4.590,00</b>

## Pointed Cushion

	Article no.	without VAT in SEK*	with VAT in SEK*
<b>40 x 60 cm</b>	<b>210 618 00</b>		
Fabric F40		1.256,00	<b>1.570,00</b>
Fabric F60		1.472,00	<b>1.840,00</b>
Fabric F80		1.720,00	<b>2.150,00</b>
Fabric F100		1.992,00	<b>2.490,00</b>
Fabric F120		2.232,00	<b>2.790,00</b>
Leather L20		3.032,00	<b>3.790,00</b>
Leather L50		4.040,00	<b>5.050,00</b>
Leather L60		5.400,00	<b>6.750,00</b>

## Pointed Cushion

	Article no.	without VAT in SEK*	with VAT in SEK*
<b>60 x 60 cm</b>	<b>210 619 00</b>		
Fabric F40		1.512,00	<b>1.890,00</b>
Fabric F60		1.760,00	<b>2.200,00</b>
Fabric F80		2.040,00	<b>2.550,00</b>
Fabric F100		2.232,00	<b>2.790,00</b>
Fabric F120		2.520,00	<b>3.150,00</b>
Leather L20		3.672,00	<b>4.590,00</b>
Leather L50		4.632,00	<b>5.790,00</b>
Leather L60		5.992,00	<b>7.490,00</b>

## Pointed Cushion

	Article no.	without VAT in SEK*	with VAT in SEK*
<b>80 x 60 cm</b>	<b>210 620 00</b>		
Fabric F40		2.232,00	<b>2.790,00</b>
Fabric F60		2.632,00	<b>3.290,00</b>
Fabric F80		3.032,00	<b>3.790,00</b>
Fabric F100		3.512,00	<b>4.390,00</b>
Fabric F120		3.832,00	<b>4.790,00</b>
Leather L20		5.160,00	<b>6.450,00</b>
Leather L50		6.312,00	<b>7.890,00</b>
Leather L60		8.000,00	<b>10.000,00</b>



# Suita cushions

Antonio Citterio, 2010/2019

**vitra.**



## Suita Cushions

Pointed cushion sets	80 x 60 cm	60 x 60 cm	60 x 40 cm	40 x 40 cm	54 x 16 cm
2-Seater	1x	1x	1x	1x	
3-Seater	1x	2x	1x	1x	
Chaise Longue large	1x	1x	1x	1x	
Chaise Longue small		1x	1x		
Daybed					1x



# Suita, tufted

Antonio Citterio, 2010/2019



## Suita Sofa, tufted

with VAT in SEK\*

F40 Laser RE Mello	F60 Olimpo Volo	F80 Corsaro Cosy 2 Dumet Iroko 2 Linho Savana	F100 Nubia Reed	F120 Credo
--------------------------	-----------------------	---	-----------------------	---------------

### Suita Sofa 2-Seater 210 601 00

Upholstery soft	61.800,00	65.700,00	69.500,00	73.700,00	77.500,00
<b>Surcharges</b>					
+ Head Section	13.700,00	14.800,00	16.000,00	17.200,00	18.300,00
+ Tray	14.900,00	14.900,00	14.900,00	14.900,00	14.900,00

### Suita Sofa 2-Seater open 210 602 00

Upholstery soft	60.400,00	64.000,00	67.300,00	70.800,00	74.300,00
<b>Surcharges</b>					
+ Tray	14.900,00	14.900,00	14.900,00	14.900,00	14.900,00

### Suita Sofa 3-Seater 210 603 00

Upholstery soft	76.800,00	81.300,00	85.800,00	90.300,00	94.900,00
<b>Surcharges</b>					
+ Head Section	14.600,00	16.000,00	17.500,00	18.900,00	20.300,00
+ Tray	17.000,00	17.000,00	17.000,00	17.000,00	17.000,00

### Suita Sofa 3-Seater open 210 604 00

Upholstery soft	74.900,00	79.300,00	83.700,00	88.000,00	92.200,00
<b>Surcharges</b>					
+ Tray	17.000,00	17.000,00	17.000,00	17.000,00	17.000,00

### Suita Sofa Chaise Longue small 210 605 00

Upholstery soft	56.500,00	59.600,00	63.000,00	65.900,00	69.000,00
<b>Surcharges</b>					
+ Head Section	9.000,00	9.550,00	10.000,00	10.700,00	11.200,00

### Suita Sofa Chaise Longue large 210 606 00

Upholstery soft	83.200,00	87.100,00	91.200,00	95.200,00	99.100,00
<b>Surcharges</b>					
+ Head Section	9.000,00	9.550,00	10.000,00	10.700,00	11.200,00

### Suita Ottoman 210 607 00

Upholstery soft	25.100,00	26.200,00	27.300,00	28.100,00	29.500,00
-----------------	-----------	-----------	-----------	-----------	-----------

### Suita Daybed, with roll cushion 210 608 00

Upholstery soft	42.500,00	44.300,00	46.500,00	48.300,00	50.300,00
-----------------	-----------	-----------	-----------	-----------	-----------

### Suita Cushions

Cushion for head section	<b>210 615 00</b>	1.130,00	1.280,00	1.470,00	1.640,00	1.790,00
Armrest cushion 59 x 15 x 27 cm	<b>210 600 00</b>	2.550,00	3.190,00	3.890,00	4.650,00	5.290,00
Armrest cushion 59x15x27 cm (set of 2)	<b>210 648 00</b>	4.250,00	4.900,00	5.600,00	6.450,00	7.100,00
Roll cushions 54 x Ø16 cm	<b>210 616 00</b>	1.430,00	1.680,00	1.910,00	2.150,00	2.450,00

# Suita, tufted

Antonio Citterio, 2010/2019

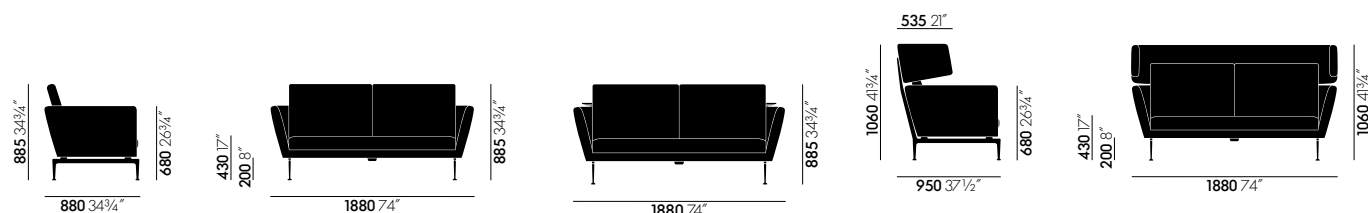

Suita Sofa 2-Seater

Suita Sofa 2-Seater  
with tray

Suita Sofa 2-Seater with head section

## Suita Sofa 2-Seater tufted

	Article no.	without VAT in SEK*	with VAT in SEK*
	<b>210 601 00</b>		
Fabric F40		49.440,00	<b>61.800,00</b>
Fabric F60		52.560,00	<b>65.700,00</b>
Fabric F80		55.600,00	<b>69.500,00</b>
Fabric F100		58.960,00	<b>73.700,00</b>
Fabric F120		62.000,00	<b>77.500,00</b>
<b>Surcharges tray</b>			
basic dark		11.920,00	<b>14.900,00</b>
<b>Surcharges header section</b>			
Fabric F40		10.960,00	<b>13.700,00</b>
Fabric F60		11.840,00	<b>14.800,00</b>
Fabric F80		12.800,00	<b>16.000,00</b>
Fabric F100		13.760,00	<b>17.200,00</b>
Fabric F120		14.640,00	<b>18.300,00</b>

Fabric F40	Fabric F60	Fabric F80	Fabric F100	Fabric F120
. Laser RE	. Olimpo	. Corsaro	. Nubia	. Credo
. Mello	. Valo	. Cosy 2 (cross stitch)	. Reed	
		. Dumer		
		. Iroko 2		
		. Linho		
		. Savana		

Base	Tray	Tray inlay
03 polished aluminium	30 basic dark powder-coated (smooth)	01 pebble
30 basic dark powder-coated (smooth)		02 charcoal

# Suita, tufted

Antonio Citterio, 2010/2019

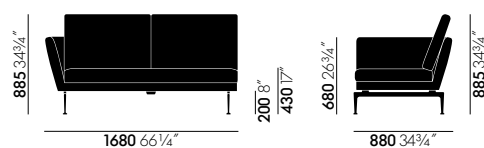

Suita Sofa 2-Seater, open, armrest left

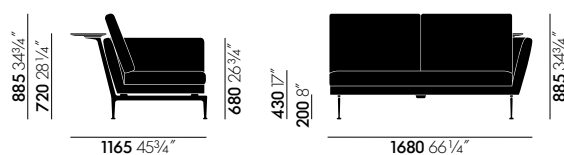

Suita Sofa 2-Seater, open, armrest right, with tray

## Suita Sofa Two-Seater open, tufted

	Article no.	without VAT in SEK*	with VAT in SEK*
	<b>210 602 00</b>		
Fabric F40		48.320,00	<b>60.400,00</b>
Fabric F60		51.200,00	<b>64.000,00</b>
Fabric F80		53.840,00	<b>67.300,00</b>
Fabric F100		56.640,00	<b>70.800,00</b>
Fabric F120		59.440,00	<b>74.300,00</b>
<b>Surcharges tray</b>			
basic dark		11.920,00	<b>14.900,00</b>

Fabric F40	Fabric F60	Fabric F80	Fabric F100	Fabric F120
· Laser RE	· Olimpo	· Corsaro	· Nubia	· Credo
· Mello	· Valo	· Cosy 2 (cross stitch)	· Reed	
		· Dumet		
		· Iroko 2		
		· Linho		
		· Savana		

Base	Tray	Tray inlay
03 polished aluminium	30 basic dark powder-coated (smooth)	01 pebble
30 basic dark powder-coated (smooth)		02 charcoal

# Suita, tufted

Antonio Citterio, 2010/2019

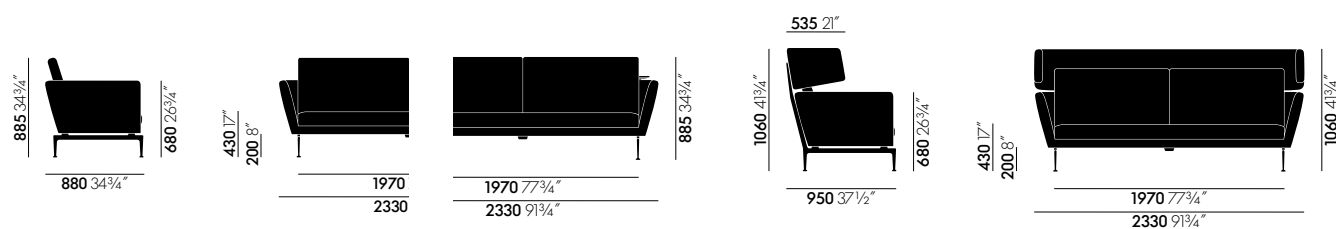

Suita Sofa 3-Seater

Suita Sofa 3-Seater with tray

Suita Sofa 3-Seater with head section

## Suita Sofa 3-Seater tufted

	Article no.	without VAT in SEK*	with VAT in SEK*
	<b>210 603 00</b>		
Fabric F40		61.440,00	<b>76.800,00</b>
Fabric F60		65.040,00	<b>81.300,00</b>
Fabric F80		68.640,00	<b>85.800,00</b>
Fabric F100		72.240,00	<b>90.300,00</b>
Fabric F120		75.920,00	<b>94.900,00</b>
<b>Surcharges tray</b>			
basic dark		13.600,00	<b>17.000,00</b>
<b>Surcharges header section</b>			
Fabric F40		11.680,00	<b>14.600,00</b>
Fabric F60		12.800,00	<b>16.000,00</b>
Fabric F80		14.000,00	<b>17.500,00</b>
Fabric F100		15.120,00	<b>18.900,00</b>
Fabric F120		16.240,00	<b>20.300,00</b>

Fabric F40	Fabric F60	Fabric F80	Fabric F100	Fabric F120
. Laser RE	. Olimpo	. Corsaro	. Nubia	. Credo
. Mello	. Valo	. Cosy 2 (cross stitch)	. Reed	
		. Dumer		
		. Iroko 2		
		. Linho		
		. Savana		

Base	Tray	Tray inlay
03 polished aluminium	30 basic dark powder-coated (smooth)	01 pebble
30 basic dark powder-coated (smooth)		02 charcoal

# Suita, tufted

Antonio Citterio, 2010/2019

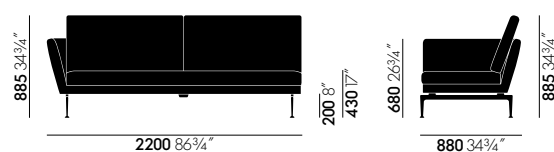

Suita Sofa 3-Seater, open, armrest left

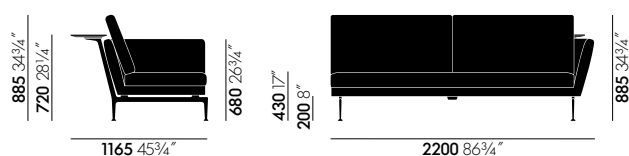

Suita Sofa 3-Seater, open, armrest right, with tray

## Suita Sofa 3-Seater open, tufted

	Article no.	without VAT in SEK*	with VAT in SEK*
	<b>210 604 00</b>		
Fabric F40		59.920,00	<b>74.900,00</b>
Fabric F60		63.440,00	<b>79.300,00</b>
Fabric F80		66.960,00	<b>83.700,00</b>
Fabric F100		70.400,00	<b>88.000,00</b>
Fabric F120		73.760,00	<b>92.200,00</b>
<b>Surcharges tray</b>			
basic dark		13.600,00	<b>17.000,00</b>

Fabric F40	Fabric F60	Fabric F80	Fabric F100	Fabric F120
. Laser RE	. Olimpo	. Corsaro	. Nubia	. Credo
. Mello	. Valo	. Cosy 2 (cross stitch)	. Reed	
		. Dumet		
		. Iroko 2		
		. Linho		
		. Savana		

Base	Tray	Tray inlay
03 polished aluminium	30 basic dark powder-coated (smooth)	01 pebble
30 basic dark powder-coated (smooth)		02 charcoal

# Suita, tufted

Antonio Citterio, 2010/2019



Suita Chaise Longue small, left

Suita Chaise Longue small, right, with head section

## Suita Chaise Longue small, tufted

	Article no.	without VAT in SEK*	with VAT in SEK*
	<b>210 605 00</b>		
Fabric F40		45.200,00	<b>56.500,00</b>
Fabric F60		47.680,00	<b>59.600,00</b>
Fabric F80		50.400,00	<b>63.000,00</b>
Fabric F100		52.720,00	<b>65.900,00</b>
Fabric F120		55.200,00	<b>69.000,00</b>
<b>Surcharges header section</b>			
Fabric F40		7.200,00	<b>9.000,00</b>
Fabric F60		7.640,00	<b>9.550,00</b>
Fabric F80		8.000,00	<b>10.000,00</b>
Fabric F100		8.560,00	<b>10.700,00</b>
Fabric F120		8.960,00	<b>11.200,00</b>

Fabric F40	Fabric F60	Fabric F80	Fabric F100	Fabric F120
. Laser RE	. Olimpo	. Corsaro	. Nubia	. Credo
. Mello	. Volo	. Cosy 2 (cross stitch)	. Reed	
		. Dumet		
		. Iroko 2		
		. Linho		
		. Savana		

### Base

- 03 polished aluminium
- 30 basic dark powder-coated (smooth)

# Suita, tufted

Antonio Citterio, 2010/2019

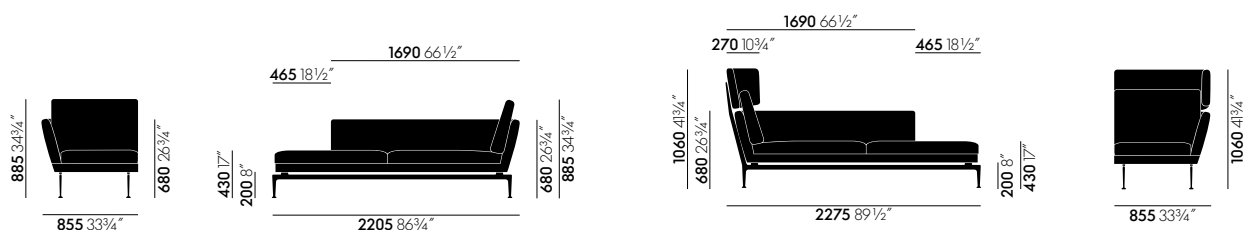

Suita Chaise Longue large, left

Suita Chaise Longue large, right, with head section

## Suita Chaise Longue large, tufted

	Article no.	without VAT in SEK*	with VAT in SEK*
	<b>210 606 00</b>		
Fabric F40		66.560,00	<b>83.200,00</b>
Fabric F60		69.680,00	<b>87.100,00</b>
Fabric F80		72.960,00	<b>91.200,00</b>
Fabric F100		76.160,00	<b>95.200,00</b>
Fabric F120		79.280,00	<b>99.100,00</b>
<b>Surcharges header section</b>			
Fabric F40		7.200,00	<b>9.000,00</b>
Fabric F60		7.640,00	<b>9.550,00</b>
Fabric F80		8.000,00	<b>10.000,00</b>
Fabric F100		8.560,00	<b>10.700,00</b>
Fabric F120		8.960,00	<b>11.200,00</b>

Fabric F40	Fabric F60	Fabric F80	Fabric F100	Fabric F120
· Laser RE	· Olimpo	· Corsaro	· Nubia	· Credo
· Mello	· Valo	· Cosy 2 (cross stitch)	· Reed	
		· Dumet		
		· Irako 2		
		· Linho		
		· Savana		

### Base

- 03 polished aluminium
- 30 basic dark powder-coated (smooth)



# Suita Ottoman & Daybed

Antonio Citterio, 2010/2019

**vitra.**

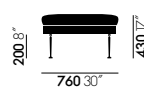
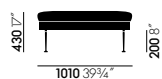

## Suita Ottoman

## Suita Daybed

### Suita Ottoman tufted

	Article no.	without VAT in SEK*	with VAT in SEK*
	<b>210 607 00</b>		
Fabric F40		20.080,00	<b>25.100,00</b>
Fabric F60		20.960,00	<b>26.200,00</b>
Fabric F80		21.840,00	<b>27.300,00</b>
Fabric F100		22.480,00	<b>28.100,00</b>
Fabric F120		23.600,00	<b>29.500,00</b>

### Suita Daybed tufted

	Article no.	without VAT in SEK*	with VAT in SEK*
<b>Daybed with roll cushion</b>	<b>210 608 00</b>		
Fabric F40		34.000,00	<b>42.500,00</b>
Fabric F60		35.440,00	<b>44.300,00</b>
Fabric F80		37.200,00	<b>46.500,00</b>
Fabric F100		38.640,00	<b>48.300,00</b>
Fabric F120		40.240,00	<b>50.300,00</b>

Fabric F40	Fabric F60	Fabric F80	Fabric F100	Fabric F120
· Laser RE	· Olimpo	· Corsaro	· Nubia	· Credo
· Mello	· Valo	· Cosy 2 (cross stitch)	· Reed	
		· Dumet		
		· Iroko 2		
		· Linho		
		· Savana		

Base	Glides, Ottoman
03 polished aluminium	04 glides for carpet
30 basic dark powder-coated (smooth)	05 felt glides for hard floor

# Suita cushions

Antonio Citterio, 2010/2019

**vitra.**

<b>Cushion for head section</b>	Article no.	without VAT in SEK*	with VAT in SEK*
	<b>210 615 00</b>		
Fabric F40		904,00	<b>1.130,00</b>
Fabric F60		1.024,00	<b>1.280,00</b>
Fabric F80		1.176,00	<b>1.470,00</b>
Fabric F100		1.312,00	<b>1.640,00</b>
Fabric F120		1.432,00	<b>1.790,00</b>
Leather L20		1.880,00	<b>2.350,00</b>
Leather L50		2.680,00	<b>3.350,00</b>
Leather L60		3.800,00	<b>4.750,00</b>

<b>Armrest cushion</b>	Article no.	without VAT in SEK*	with VAT in SEK*
<b>59 x 15 x 27 cm</b>	<b>210 600 00</b>		
Fabric F40		2.040,00	<b>2.550,00</b>
Fabric F60		2.552,00	<b>3.190,00</b>
Fabric F80		3.112,00	<b>3.890,00</b>
Fabric F100		3.720,00	<b>4.650,00</b>
Fabric F120		4.232,00	<b>5.290,00</b>
Leather L20		4.312,00	<b>5.390,00</b>
Leather L50		6.552,00	<b>8.190,00</b>
Leather L60		9.600,00	<b>12.000,00</b>

<b>Armrest cushion (set of 2)</b>	Article no.	without VAT in SEK*	with VAT in SEK*
<b>59 x 15 x 27 cm</b>	<b>210 648 00</b>		
Fabric F40		3.400,00	<b>4.250,00</b>
Fabric F60		3.920,00	<b>4.900,00</b>
Fabric F80		4.480,00	<b>5.600,00</b>
Fabric F100		5.160,00	<b>6.450,00</b>
Fabric F120		5.680,00	<b>7.100,00</b>
Leather L20		8.720,00	<b>10.900,00</b>
Leather L50		12.960,00	<b>16.200,00</b>
Leather L60		19.120,00	<b>23.900,00</b>

<b>Suita bolster cushion</b>	Article no.	without VAT in SEK*	with VAT in SEK*
<b>54 x ø 16 mm</b>	<b>210 616 00</b>		
Fabric F40		1.144,00	<b>1.430,00</b>
Fabric F60		1.344,00	<b>1.680,00</b>
Fabric F80		1.528,00	<b>1.910,00</b>
Fabric F100		1.720,00	<b>2.150,00</b>
Fabric F120		1.960,00	<b>2.450,00</b>
Leather L20		2.200,00	<b>2.750,00</b>
Leather L50		3.080,00	<b>3.850,00</b>
Leather L60		4.312,00	<b>5.390,00</b>

# Suita cushions

Antonio Citterio, 2010/2019

**vitra.**



## Pointed Cushion

	Article no.	without VAT in SEK*	with VAT in SEK*
<b>40 x 40 cm</b>	<b>210 617 00</b>		
Fabric F40		744,00	<b>930,00</b>
Fabric F60		904,00	<b>1.130,00</b>
Fabric F80		1.064,00	<b>1.330,00</b>
Fabric F100		1.224,00	<b>1.530,00</b>
Fabric F120		1.392,00	<b>1.740,00</b>
Leather L20		1.760,00	<b>2.200,00</b>
Leather L50		2.600,00	<b>3.250,00</b>
Leather L60		3.672,00	<b>4.590,00</b>

## Pointed Cushion

	Article no.	without VAT in SEK*	with VAT in SEK*
<b>40 x 60 cm</b>	<b>210 618 00</b>		
Fabric F40		1.256,00	<b>1.570,00</b>
Fabric F60		1.472,00	<b>1.840,00</b>
Fabric F80		1.720,00	<b>2.150,00</b>
Fabric F100		1.992,00	<b>2.490,00</b>
Fabric F120		2.232,00	<b>2.790,00</b>
Leather L20		3.032,00	<b>3.790,00</b>
Leather L50		4.040,00	<b>5.050,00</b>
Leather L60		5.400,00	<b>6.750,00</b>

## Pointed Cushion

	Article no.	without VAT in SEK*	with VAT in SEK*
<b>60 x 60 cm</b>	<b>210 619 00</b>		
Fabric F40		1.512,00	<b>1.890,00</b>
Fabric F60		1.760,00	<b>2.200,00</b>
Fabric F80		2.040,00	<b>2.550,00</b>
Fabric F100		2.232,00	<b>2.790,00</b>
Fabric F120		2.520,00	<b>3.150,00</b>
Leather L20		3.672,00	<b>4.590,00</b>
Leather L50		4.632,00	<b>5.790,00</b>
Leather L60		5.992,00	<b>7.490,00</b>

## Pointed Cushion

	Article no.	without VAT in SEK*	with VAT in SEK*
<b>80 x 60 cm</b>	<b>210 620 00</b>		
Fabric F40		2.232,00	<b>2.790,00</b>
Fabric F60		2.632,00	<b>3.290,00</b>
Fabric F80		3.032,00	<b>3.790,00</b>
Fabric F100		3.512,00	<b>4.390,00</b>
Fabric F120		3.832,00	<b>4.790,00</b>
Leather L20		5.160,00	<b>6.450,00</b>
Leather L50		6.312,00	<b>7.890,00</b>
Leather L60		8.000,00	<b>10.000,00</b>

# Suita cushions

Antonio Citterio, 2010/2019

**vitra.**



## Suita Cushions

Pointed cushion sets	80 x 60 cm	60 x 60 cm	60 x 40 cm	40 x 40 cm	54 x 16 cm
2-Seater	1x	1x	1x	1x	
3-Seater	1x	2x	1x	1x	
Chaise Longue large	1x	1x	1x	1x	
Chaise Longue small		1x	1x		
Daybed					1x

# Suita Club Sofa

Antonio Citterio, 2010

**vitra.**

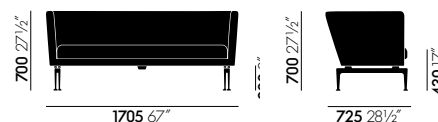

## Suita Club Sofa and Armchair:

**Body:** moulded polyurethane foam with webbed metal frame.

**Seat cushion:** polyurethane foam and polyester fibre.

**Seat height:** 430 mm (355 mm with applied load, measured in accordance with EN 1335-1:2000).

**Legs:** die-cast aluminium, polished or powder-coated.

**Glides for Suita Club Sofa:** non-slip glides.

**Glides for Suita Club Armchair:** glides for carpet or felt glides for hard floors.

## Suita Club Sofa

	Article no.	without VAT in SEK*	with VAT in SEK*
	<b>210 338 00</b>		
Fabric F40		37.120,00	<b>46.400,00</b>
Fabric F60		39.840,00	<b>49.800,00</b>
Fabric F120		48.480,00	<b>60.600,00</b>
Leather L20		54.160,00	<b>67.700,00</b>
Leather L50		66.640,00	<b>83.300,00</b>

Fabric F40	Fabric F60	Fabric F120	Leather L20	Leather L50	Base
. Laser RE	. Volo	. Credo	. Leather	. Leather Premium F	03 polished aluminium 30 basic dark powder-coated (smooth)

# Suita Club Armchair

Antonio Citterio, 2010

**vitra.**

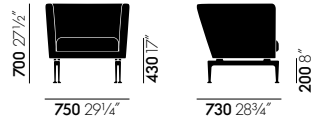

## Suita Club Armchair

	Article no.	without VAT in SEK*	with VAT in SEK*
	<b>210 333 00</b>		
Fabric F40		21.680,00	<b>27.100,00</b>
Fabric F60		23.360,00	<b>29.200,00</b>
Fabric F80		23.920,00	<b>29.900,00</b>
Fabric F100		25.040,00	<b>31.300,00</b>
Fabric F120		26.720,00	<b>33.400,00</b>
Leather L20		29.520,00	<b>36.900,00</b>
Leather L50		38.240,00	<b>47.800,00</b>
Leather L60		50.720,00	<b>63.400,00</b>

Fabric F40	Fabric F60	Fabric F80	Fabric F100	Fabric F120	Leather L20	Leather L50	Leather L60
· Laser RE · Mello	· Olimpo · Velo	· Corsaro · Cosy 2 (cross stitch) · Dumet · Iroko 2 · Linho · Savana	· Nubia · Reed	· Credo	· Leather	· Leather Premium F	· Leather Natural F

Base	Glides
03 polished aluminium 30 basic dark powder-coated (smooth)	04 glides for carpet 05 felt glides for hard floor

# Vlinder Sofa

Hella Jongerius, 2018

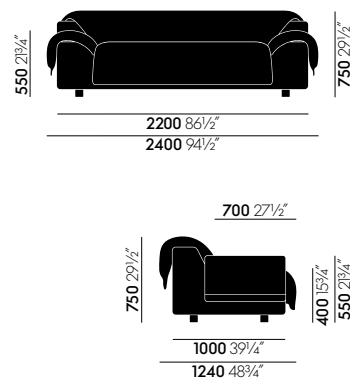

All measurements are pursuant to EN 1335-1:2000  
More detailed information is found in the chapter 'Explanation of measurements'.

**Body frame:** wooden construction, with zigzag springs in the seat section and upholstery webbing in the backrest.

**Upholstery construction (body):** multilayer polyurethane foam in different levels of firmness, top layer made of viscoelastic foam, with polyester fleece.

**Cover:** chamber cushion structure, filled with a mix of goose feathers and down, as well as polyurethane and latex rods. Three-part design (two armrest sections, one seat-backrest section). Secured to sofa body with zip fasteners.

**Seat height with cover:** 400 mm (270 mm with applied load, measured in accordance with EN 1335-1:2000).

**Covers:** all covers are removable.

**Glides:** steel legs with felt glides

**Note:** designed only for private use. We recommend that the cover is regularly shaken.

Vlinder Sofa	Article no.	without VAT in SEK*	with VAT in SEK*
dark reds	210 588 01	95.760,00	119.700,00
dark greens	210 588 02	95.760,00	119.700,00
light reds	210 588 03	95.760,00	119.700,00
light greens	210 588 04	95.760,00	119.700,00

## Coffee and side tables



Abalon Table  
R & E Bouroullec  
360



Coffee Table  
Isamu Noguchi  
361



Eames Coffee Table  
Charles & Ray Eames  
362



Elliptical Table ETR  
Charles & Ray Eames  
363



Flower Table  
Alexander Girard  
364



Guéridon Bas  
Jean Prouvé  
365



Metal Side Table  
R & E Bouroullec  
366



Wooden Side Table  
R & E Bouroullec  
369



NesTable  
Jasper Morrison  
370



Occasional Low Table  
Jasper Morrison  
371



Occasional Table LTR  
Charles & Ray Eames  
372



Plate Table  
Jasper Morrison  
373



Office and conference chairs (swivel)

Chairs

Tables

Desks

Public waiting areas

Lounge chairs and armchairs

Sofas

Coffee and side tables

Stools and benches

Storage and partition elements

Accessories

Living, dining, decorative objects, home office,  
clocks, lighting, publications

Quick Ship programme

General terms, conditions  
and information

# Abalon Table

Ronan & Erwan Bouroullec, 2022

vitra.

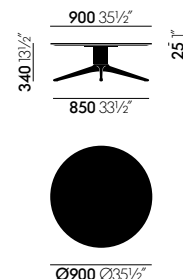

All measurements are pursuant to EN 1335-1:2000  
More detailed information is found in the chapter 'Explanation of measurements'.

**Table top:** base material MDF (medium-density fibreboard) in real oak veneer or textured powder-coated finish; table thickness 25 mm with 15° bevelled edge.

**Base:** non-swivel four-star base in die-cast aluminium, powder-coated finish, pedestal in steel, powder-coated finish.

**Glides:** plastic glides for soft floors or felt glides for hard floors.

Abalon Table	Article no.	without VAT in SEK*	with VAT in SEK*
	<b>210 743 00</b>		
MDF powder-coated in soft light	B1S52	10.720,00	<b>13.400,00</b>
MDF powder-coated in basic dark	B1S30	10.720,00	<b>13.400,00</b>
light oak	C1S17	17.200,00	<b>21.500,00</b>
dark oak	C1S04	17.200,00	<b>21.500,00</b>

#### Base

12 deep black powder-coated (smooth)  
91 mint powder-coated (smooth)

#### Glides (Platform and Table)

04 glides for carpet  
05 felt glides for hard floor

# Coffee Table

Isamu Noguchi, 1944

vitra.

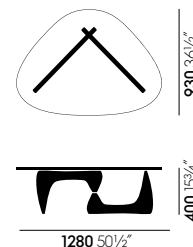

**Table top:** heavy glass, 19 mm, ground rounded edges.

**Base:** solid ash in black, walnut or maple, lacquered finish, rounded edges.

**Origin of wood:** ash (*Fraxinus excelsior*), walnut (*Juglans nigra*) and maple (*Acer platanoides*) from Western Europe and/or Poland.

Coffee Table	Article no.	without VAT in SEK*	with VAT in SEK*
black ash	201 300 01	23.200,00	29.000,00
walnut	201 300 02	32.880,00	41.100,00
maple	201 300 03	23.200,00	29.000,00

# Eames Coffee Table

Charles & Ray Eames, 1953

vitra.

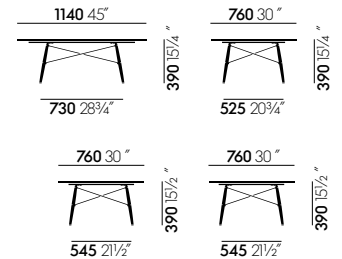

**Table top:** solid American walnut with oiled finish or Carrara marble, brushed and waxed.

**Base platform:** MDF board.

**Base:** solid ash, honey-coloured or black finish; steel rod cross struts, powder-coated in basic dark.

**Origin of wood:** ash (*Fraxinus excelsior*) from Western Europe and/or Poland; American walnut (*Juglans nigra*) from the USA.

## Eames Coffee Table, 1140 x 760

	Article no.	without VAT in SEK*	with VAT in SEK*
white marble, base in black ash	210 521 21	22.480,00	28.100,00
white marble, base in honey-toned ash	210 521 22	22.480,00	28.100,00
solid American walnut, oiled finish, base in black ash	210 521 31	27.920,00	34.900,00
solid American walnut, oiled finish, base in honey-toned ash	210 521 32	27.920,00	34.900,00
Base black ash	for stone table tops	210 521 91	8.160,00
Base ash honey tone	for stone table tops	210 521 92	8.160,00

## Eames Coffee Table square, 760 x 760

	Article no.	without VAT in SEK*	with VAT in SEK*
white marble, base in black ash	210 520 21	20.160,00	25.200,00
white marble, base in honey-toned ash	210 520 22	20.160,00	25.200,00
solid American walnut, oiled finish, base in black ash	210 520 31	22.560,00	28.200,00
solid American walnut, oiled finish, base in honey-toned ash	210 520 32	22.560,00	28.200,00
Base black ash	for stone table tops	210 520 91	6.952,00
Base ash honey tone	for stone table tops	210 520 92	6.952,00

# Elliptical Table ETR

Charles & Ray Eames, 1951

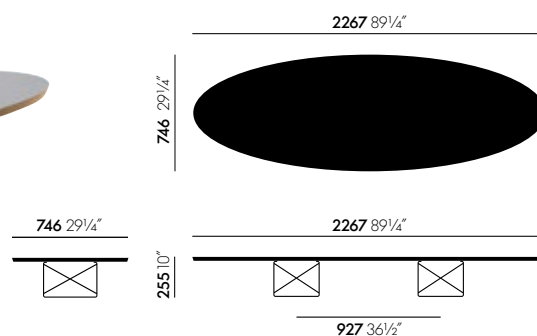

**Table top:** plywood core, high-pressure laminate surface.

**Base:** steel wire, chrome-plated or powder-coated.

**Range of use:** recommended for residential use only.

## Elliptical Table ETR

	Article no.	without VAT in SEK*	with VAT in SEK*
HPL black, base chromed	412 106 00	19.880,00	24.850,00
HPL white, base chromed	412 107 00	19.880,00	24.850,00
HPL black, base powder-coated in basic dark	412 106 01	19.880,00	24.850,00
HPL white, base powder-coated in basic dark	412 107 01	19.880,00	24.850,00

# Flower Table

Alexander Girard, 1977

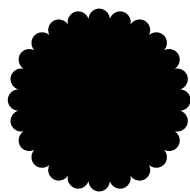

Ø800 31½"

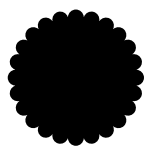

Ø600 23½"

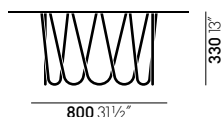

800 31½"

330 13"

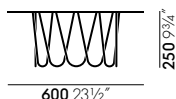

600 23½"

250 9¾"

Flower Table, large

Flower Table, small

- **Table top and base:** powder-coated steel. Suited for outdoor use.



Flower Table

Large, anthracite

**201 390 06**

SEK\* 7.880,00 / **9.850,00**



Flower Table

Small, anthracite

**201 390 05**

SEK\* 6.040,00 / **7.550,00**



Flower Table

large, red

**201 390 02**

SEK\* 7.880,00 / **9.850,00**



Flower Table

Small, red

**201 390 01**

SEK\* 6.040,00 / **7.550,00**

# Guéridon Bas

Jean Prouvé, 1944

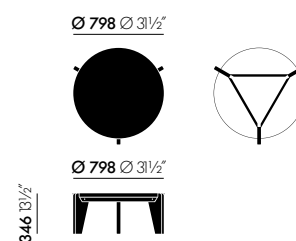

**Table top:** solid wood in natural oak with oiled finish, dark stained oak with protective natural lacquer finish, or American walnut with oiled finish.

**Base:** legs matched to table top, solid wood in natural oak with oiled finish, dark stained oak with protective natural lacquer finish, or American walnut with oiled finish; connecting element: bent sheet metal, powder-coated (smooth) in deep black.

**Origin of wood:** oak (*Quercus robur*) from Western Europe and/or Poland; American walnut (*Juglans nigra*) from the USA.

## Guéridon Bas

	Article no.	without VAT in SEK*	with VAT in SEK*
	<b>212 043 00</b>		
solid natural oak, oiled	70	21.000,00	<b>26.250,00</b>
solid dark oak, with protective varnish	04	24.200,00	<b>30.250,00</b>
solid American walnut, oiled	75	27.080,00	<b>33.850,00</b>

# Metal Side Tables

Ronan & Erwan Bouroullec, 2004

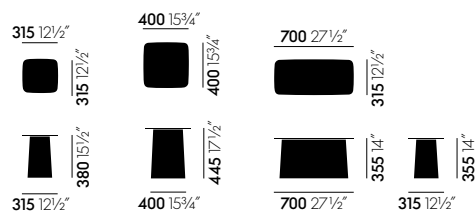

**Table top and base:** bent and welded sheet steel, powder-coated with highly polished finish.

**Glides:** felt glides.



**Metal Side Table**

white

**210 167 01**

SEK\* 5.240,00 / **6.550,00**



**Metal Side Table**

white

**210 166 01**

SEK\* 6.120,00 / **7.650,00**



**Metal Side Table**

white

**210 165 01**

SEK\* 7.000,00 / **8.750,00**



**Metal Side Table**

chocolate

**210 167 04**

SEK\* 5.240,00 / **6.550,00**



**Metal Side Table**

chocolate

**210 166 04**

SEK\* 6.120,00 / **7.650,00**



**Metal Side Table**

chocolate

**210 165 04**

SEK\* 7.000,00 / **8.750,00**



# Metal Side Tables

## Ronan & Erwan Bouroullec, 2004

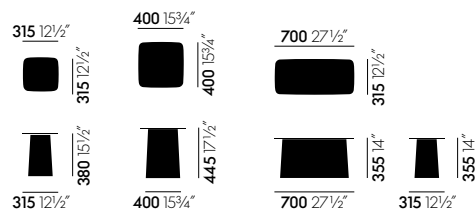

**Table top and base:** bent and welded sheet steel, galvanised, optional powder-coating with fine surface texture. The galvanised version is finished with an irregular surface polish.

**Glides:** polyamide.

**Applications:** galvanised Metal Side Tables, optionally powder-coated with a fine surface texture, are suitable for indoor and outdoor use. If used frequently outdoors, the galvanised version without powder coating can acquire a typical patina over time.



**Metal Side Table (Outdoor)**

soft light

**210 506 52**

SEK\* 5.752,00 / **7.190,00**



**Metal Side Table (Outdoor)**

soft light

**210 507 52**

SEK\* 6.600,00 / **8.250,00**



**Metal Side Table (Outdoor)**

soft light

**210 508 52**

SEK\* 7.672,00 / **9.590,00**



**Metal Side Table (Outdoor)**

ice grey

**210 506 23**

SEK\* 5.752,00 / **7.190,00**



**Metal Side Table (Outdoor)**

ice grey

**210 507 23**

SEK\* 6.600,00 / **8.250,00**



**Metal Side Table (Outdoor)**

ice grey

**210 508 23**

SEK\* 7.672,00 / **9.590,00**



**Metal Side Table (Outdoor)**

dim grey

**210 506 21**

SEK\* 5.752,00 / **7.190,00**



**Metal Side Table (Outdoor)**

dim grey

**210 507 21**

SEK\* 6.600,00 / **8.250,00**



**Metal Side Table (Outdoor)**

dim grey

**210 508 21**

SEK\* 7.672,00 / **9.590,00**

# Metal Side Tables

Ronan & Erwan Bouroullec, 2004

---



**Metal Side Table (Outdoor)**

black

**210 506 12**

SEK\* 5.752,00 / **7.190,00**

---



**Metal Side Table (Outdoor)**

black

**210 507 12**

SEK\* 6.600,00 / **8.250,00**

---



**Metal Side Table (Outdoor)**

black

**210 508 12**

SEK\* 7.672,00 / **9.590,00**

---



**Metal Side Table (Outdoor)**

galvanised

**215 121 01**

SEK\* 5.240,00 / **6.550,00**

---



**Metal Side Table (Outdoor)**

galvanised

**215 122 01**

SEK\* 6.120,00 / **7.650,00**

---



**Metal Side Table (Outdoor)**

galvanised

**215 123 01**

SEK\* 7.000,00 / **8.750,00**

---

# Wooden Side Tables

Ronan & Erwan Bouroullec, 2015

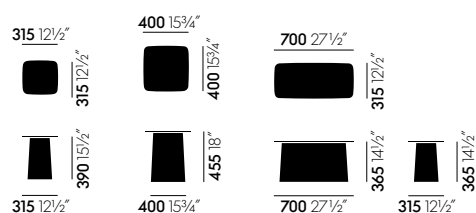

**Table top and base:** moulded plywood.

**Glides:** felt glides.



**Wooden Side Table small**

light oak

**210 512 11**

SEK\* 7.960,00 / **9.950,00**



**Wooden Side Table medium**

light oak

**210 513 11**

SEK\* 9.080,00 / **11.350,00**



**Wooden Side Table large**

light oak

**210 514 11**

SEK\* 10.920,00 / **13.650,00**



**Wooden Side Table small**

dark oak

**210 512 12**

SEK\* 7.960,00 / **9.950,00**



**Wooden Side Table medium**

dark oak

**210 513 12**

SEK\* 9.080,00 / **11.350,00**



**Wooden Side Table large**

dark oak

**210 514 12**

SEK\* 10.920,00 / **13.650,00**



**Wooden Side Table small**

walnut

**210 512 13**

SEK\* 8.600,00 / **10.750,00**



**Wooden Side Table medium**

walnut

**210 513 13**

SEK\* 9.560,00 / **11.950,00**



**Wooden Side Table large**

walnut

**210 514 13**

SEK\* 11.400,00 / **14.250,00**

## NesTable

Jasper Morrison, 2007



**Tray:** polyurethane.

**Column:** steel, powder-coated textured finish.

**Extension bar:** steel, polished chrome finish.

**Base:** die-cast aluminium, powder-coated textured finish.

**NesTable**

basic dark

H 574 x W 500 x D 350 mm

**860 130 14**SEK\* 6.760,00 / **8.450,00****NesTable**

soft mint

H 574 x W 500 x D 350 mm

**860 130 18**SEK\* 6.760,00 / **8.450,00****NesTable**

sea blue

H 574 x W 500 x D 350 mm

**860 130 21**SEK\* 6.760,00 / **8.450,00****NesTable**

bright red

H 574 x W 500 x D 350 mm

**860 130 20**SEK\* 6.760,00 / **8.450,00****NesTable**

soft light

H 574 x W 500 x D 350 mm

**860 130 15**SEK\* 6.760,00 / **8.450,00****NesTable**

ice grey

H 574 x W 500 x D 350 mm

**860 130 19**SEK\* 6.760,00 / **8.450,00****NesTable**

warm grey

H 574 x W 500 x D 350 mm

**860 130 17**SEK\* 6.760,00 / **8.450,00**

# Occasional Low Table

Jasper Morrison, 2016

vitra.

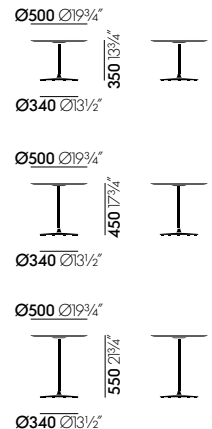

**Table top:** solid wood in natural oak with oiled finish, dark stained oak with protective natural lacquer finish, or American walnut with oiled finish; or die-cast aluminium with powder-coated textured finish.

**Column:** steel, powder-coated textured finish.

**Base:** die-cast zinc, powder-coated textured finish.

**Origin of wood:** oak (*Quercus robur*) from Western Europe and/or Poland; American walnut (*Juglans nigra*) from the USA.

## Occasional Low Table 35

	Article no.	without VAT in SEK*	with VAT in SEK*
aluminium, powder-coated in chocolate, base in chocolate	210 515 11	5.800,00	7.250,00
solid natural oak, oiled finish, base in chocolate	210 515 21	6.792,00	8.490,00
Dark stained oak with protective natural lacquer finish, base in colour chocolate	210 515 24	6.792,00	8.490,00
solid American walnut, oiled finish, base in chocolate	210 515 23	8.600,00	10.750,00

## Occasional Low Table 45

	Article no.	without VAT in SEK*	with VAT in SEK*
aluminium, powder-coated in chocolate, base in chocolate	210 516 11	5.880,00	7.350,00
solid natural oak, oiled finish, base in chocolate	210 516 21	6.872,00	8.590,00
Dark stained oak with protective natural lacquer finish, base in colour chocolate	210 516 24	6.872,00	8.590,00
solid American walnut, oiled finish, base in chocolate	210 516 23	8.600,00	10.750,00

## Occasional Low Table 55

	Article no.	without VAT in SEK*	with VAT in SEK*
aluminium, powder-coated in chocolate, base in chocolate	210 517 11	5.960,00	7.450,00
solid natural oak, oiled finish, base in chocolate	210 517 21	6.952,00	8.690,00
Dark stained oak with protective natural lacquer finish, base in colour chocolate	210 517 24	6.952,00	8.690,00
solid American walnut, oiled finish, base in chocolate	210 517 23	8.760,00	10.950,00

# Occasional Table LTR

Charles & Ray Eames, 1950

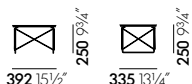

**Wooden table top:** solid wood in natural oak with oiled finish, dark stained oak with protective natural lacquer finish, or American walnut with oiled finish.

**Origin of wood:** oak (*Quercus robur*) from Western Europe and/or Poland; American walnut (*Juglans nigra*) from the USA.

**HPL table top:** plywood core, high-pressure laminate surface.

**Gold leaf table top:** plywood core, gilded surface with transparent coating.

**Marble table top:** Carrara marble (Italy).

**Base:** steel wire, chrome-plated or powder-coated.



**Occasional Table LTR**

HPL white,  
base chromed

**201 195 03**

SEK\* 2.760,00 / **3.450,00**



**Occasional Table LTR**

HPL black,  
base chromed

**201 195 04**

SEK\* 2.760,00 / **3.450,00**



**Occasional Table LTR**

gold leaf,  
base chromed

**201 195 09**

SEK\* 5.960,00 / **7.450,00**



**Occasional Table LTR**

solid American walnut,  
base chromed

**201 195 13**

SEK\* 4.312,00 / **5.390,00**



**Occasional Table LTR**

HPL white,  
base basic dark

**201 195 33**

SEK\* 2.760,00 / **3.450,00**



**Occasional Table LTR**

HPL black,  
base basic dark

**201 195 30**

SEK\* 2.760,00 / **3.450,00**



**Occasional Table LTR**

gold leaf,  
base basic dark

**201 195 39**

SEK\* 5.960,00 / **7.450,00**



**Occasional Table LTR**

solid American walnut,  
base basic dark

**201 195 16**

SEK\* 4.312,00 / **5.390,00**



**Occasional Table LTR**

natural solid oak,  
base chromed

**201 195 11**

SEK\* 3.432,00 / **4.290,00**



**Occasional Table LTR**

dark solid oak,  
base chromed

**201 195 20**

SEK\* 3.640,00 / **4.550,00**



**Occasional Table LTR**

Light-coloured marble,  
chrome-plated base

**201 195 18**

SEK\* 6.440,00 / **8.050,00**



**Occasional Table LTR**

natural solid oak,  
base basic dark

**201 195 14**

SEK\* 3.432,00 / **4.290,00**



**Occasional Table LTR**

dark solid oak,  
base basic dark

**201 195 21**

SEK\* 3.640,00 / **4.550,00**



**Occasional Table LTR**

Light-coloured marble,  
base in basic dark

**201 195 19**

SEK\* 6.440,00 / **8.050,00**

# Plate Table

Jasper Morrison, 2004



**Table top:** solid natural oak with oiled finish or dark stained oak with protective natural lacquer finish; powder-coated MDF; or Carrara marble, brushed and waxed; table thickness 15 mm.

**Base:** die-cast aluminium and powder-coated tubular steel.

**Origin of wood:** oak (*Quercus robur*) from Western Europe and/or Poland.

Plate Table 410 x 410	Article no.	without VAT in SEK*	with VAT in SEK*
Carrara marble, base powder-coated in white (textured finish)	210 540 11	13.760,00	17.200,00
MDF white, base powder-coated in white (textured finish)	210 540 31	9.120,00	11.400,00
MDF in basic dark, base powder-coated in basic dark (textured)	210 540 33	9.120,00	11.400,00
Solid natural oak, oiled finish, base powder- coated in basic dark (textured)	210 540 24	10.080,00	12.600,00
Dark oak, protective natural lacquer finish, base powder-coated in basic dark (textured)	210 540 25	12.080,00	15.100,00

Plate Table 410 x 710	Article no.	without VAT in SEK*	with VAT in SEK*
Carrara marble, base powder-coated in white (textured finish)	210 542 11	14.640,00	18.300,00
MDF white, base powder-coated in white (textured finish)	210 542 31	10.080,00	12.600,00
MDF in basic dark, base powder-coated in basic dark (textured)	210 542 33	10.080,00	12.600,00
Solid natural oak, oiled finish, base powder- coated in basic dark (textured)	210 542 24	12.080,00	15.100,00
Dark oak, protective natural lacquer finish, base powder-coated in basic dark (textured)	210 542 25	13.120,00	16.400,00

# Plate Table

Jasper Morrison, 2004

**vitra.**

## Plate Table 410 x 1130

	Article no.	without VAT in SEK*	with VAT in SEK*
Carrara marble, base powder-coated in white (textured finish)	210 543 11	18.880,00	23.600,00
MDF white, base powder-coated in white (textured finish)	210 543 31	12.080,00	15.100,00
MDF in basic dark, base powder-coated in basic dark (textured)	210 543 33	12.080,00	15.100,00
Solid natural oak, oiled finish, base powder- coated in basic dark (textured)	210 543 24	14.640,00	18.300,00
Dark oak, protective natural lacquer finish, base powder-coated in basic dark (textured)	210 543 25	16.240,00	20.300,00

## Plate Table 710 x 710

	Article no.	without VAT in SEK*	with VAT in SEK*
Carrara marble, base powder-coated in white (textured finish)	210 541 11	18.880,00	23.600,00
MDF white, base powder-coated in white (textured finish)	210 541 31	12.400,00	15.500,00
MDF in basic dark, base powder-coated in basic dark (textured)	210 541 33	12.400,00	15.500,00
Solid natural oak, oiled finish, base powder- coated in basic dark (textured)	210 541 24	14.160,00	17.700,00
Dark oak, protective natural lacquer finish, base powder-coated in basic dark (textured)	210 541 25	16.320,00	20.400,00

## Plate Table 710 x 1130

	Article no.	without VAT in SEK*	with VAT in SEK*
Carrara marble, base powder-coated in white (textured finish)	210 544 11	27.040,00	33.800,00
MDF white, base powder-coated in white (textured finish)	210 544 31	16.640,00	20.800,00
MDF in basic dark, base powder-coated in basic dark (textured)	210 544 33	16.640,00	20.800,00
Solid natural oak, oiled finish, base powder- coated in basic dark (textured)	210 544 24	19.680,00	24.600,00
Dark oak, protective natural lacquer finish, base powder-coated in basic dark (textured)	210 544 25	23.280,00	29.100,00





## Stools and benches



Bovist  
Hella Jongerius  
378



Butterfly Stool  
Sori Yanagi  
379



Chap  
Konstantin Grcic  
380



Cork Family  
Jasper Morrison  
381



Elephant Stool  
Sori Yanagi  
382



Nelson Bench  
George Nelson  
383



Stools  
Charles & Ray Eames  
384



Tabouret 307  
Jean Prouvé  
385



Tabouret Bois  
Jean Prouvé  
386



Tabouret Métallique  
Jean Prouvé  
387



Visiona Stool  
Verner Panton  
388



Wiggle Stool  
Frank Gehry  
389

---

## Other products in this chapter



Wiggle Side Chair  
Frank Gehry  
389

Office and conference chairs (swivel)

Chairs

Tables

Desks

Public waiting areas

Lounge chairs and armchairs

Sofas

Coffee and side tables

**Stools and benches**

Storage and partition elements

**Accessories**

Living, dining, decorative objects, home office,  
clocks, lighting, publications

Quick Ship programme

General terms, conditions  
and information



# Bovist

Hella Jongerius, 2019



380 15

Ø540 Ø214

All measurements are pursuant to EN 1335-1:2000  
More detailed information is found in the chapter 'Explanation of measurements'.

**Filling:** synthetic beads.

**Upholstery cover:** Tailored Fabric (87% new wool, 7% cotton, 6% polyamide).

**Bottom cover:** Pure (UK: Volo).



## Bovist

dark reds

**210 589 01**

SEK\* 7.032,00 / **8.790,00**



## Bovist

dark greens

**210 589 02**

SEK\* 7.032,00 / **8.790,00**



## Bovist

light greens

**210 589 04**

SEK\* 7.032,00 / **8.790,00**



## Bovist

light reds

**210 589 03**

SEK\* 7.032,00 / **8.790,00**

# Butterfly Stool

Sori Yanagi, 1954

---



**Material:** moulded maple plywood with natural finish (Germany/France) or santos palisander (Bolivia), brass fittings.

---



## Butterfly Stool

moulded plywood

maple

**201 370 01**

SEK\* 6.872,00 / **8.590,00**

---



## Butterfly Stool

moulded plywood

palisander

**201 370 02**

SEK\* 8.600,00 / **10.750,00**

---

# Chap

Konstantin Grcic, 2021

vitra.



**Material:** recycled polypropylene, 100% recyclable.



**Chap**  
deep black RE  
**201 393 01**  
SEK\* 840,00 / 1.050,00



**Chap**  
brick RE  
**201 393 04**  
SEK\* 840,00 / 1.050,00



**Chap**  
dark grey RE  
**201 393 02**  
SEK\* 840,00 / 1.050,00



**Chap**  
sea blue RE  
**201 393 03**  
SEK\* 840,00 / 1.050,00



**Chap Tray**  
deep black RE  
**201 398 01**  
SEK\* 280,00 / 350,00



**Chap Tray**  
brick RE  
**201 398 04**  
SEK\* 280,00 / 350,00



**Chap Tray**  
dark grey RE  
**201 398 02**  
SEK\* 280,00 / 350,00



**Chap Tray**  
sea blue RE  
**201 398 03**  
SEK\* 280,00 / 350,00

# Cork Family

Jasper Morrison, 2004

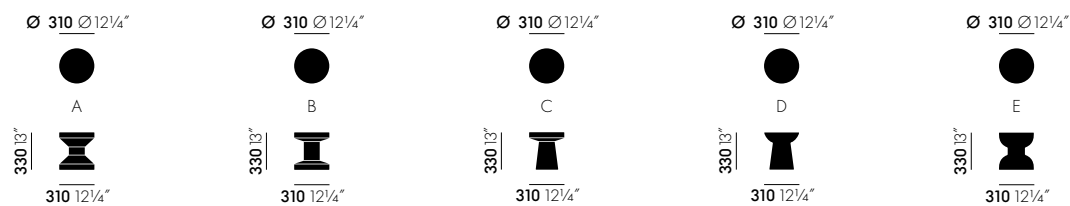

**Material:** pure cork, lathe-turned, untreated surface.



## Cork Family

Model A

**210 012 01**

SEK\* 4.152,00 / **5.190,00**



## Cork Family

Model B

**210 023 01**

SEK\* 4.152,00 / **5.190,00**



## Cork Family

Model C

**210 024 01**

SEK\* 4.152,00 / **5.190,00**



## Cork Family

Model D

**210 646 01**

SEK\* 4.152,00 / **5.190,00**



## Cork Family

Model E

**210 647 01**

SEK\* 4.152,00 / **5.190,00**

# Elephant Stool

Sori Yanagi, 1954

---



**Material:** dyed-through polypropylene.

**Applications:** suitable for outdoor use. Special additives help to prevent colours from fading due to UV radiation. However, if the stool is exposed to sunlight for prolonged periods, the colour may change over time. We recommend limited exposure to sunlight.

---



## Elephant Stool

black

**210 020 02**

SEK\* 952,00 / **1.190,00**

---



## Elephant Stool

cream

**210 020 30**

SEK\* 952,00 / **1.190,00**

---



# Nelson Bench

George Nelson, 1946



**Seat:** slatted wood in solid ash, lacquered.

**Base:** ash, lacquered in black.

**Applications:** not recommended for public spaces.

**Origin of wood:** ash (*Fraxinus excelsior*) from Western Europe and/or Poland.



## Nelson Bench

H 353 x W 1220 x D 469 mm

black ash

**210 231 02**

SEK\* 7.880,00 / **9.850,00**



## Nelson Bench

H 353 x W 1837 x D 469 mm

black ash

**405 502 02**

SEK\* 11.560,00 / **14.450,00**



## Nelson Bench

H 353 x W 1220 x D 469 mm

natural ash

**210 231 01**

SEK\* 7.880,00 / **9.850,00**



## Nelson Bench

H 353 x W 1837 x D 469 mm

natural ash

**405 502 00**

SEK\* 11.560,00 / **14.450,00**

# Stools

Charles & Ray Eames, 1960

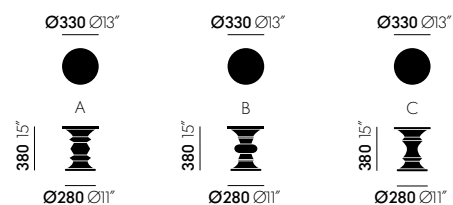

Model A

Model B

Model C

**Material:** laminated sections of solid walnut, lathe-turned, transparent lacquer finish.

**Origin of wood:** walnut (*Juglans nigra*) from Western Europe and/or Poland.

Stools		Article no.	without VAT in SEK*	with VAT in SEK*
Model A	solid walnut	412 355 01	14.280,00	17.850,00
Model B	solid walnut	412 356 01	14.280,00	17.850,00
Model C	solid walnut	412 357 01	14.280,00	17.850,00

# Tabouret N° 307

Jean Prouvé, 1951

vitra.

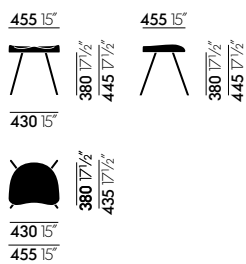

**Base:** steel, powder-coated finish.

**Seat:** solid natural oak with oiled finish or solid dark stained oak with clear protective lacquer finish. Plastic glides.



## Tabouret 307

Natural solid oak

**212 059 70**

SEK\* 7.112,00 / **8.890,00**



## Tabouret 307

Dark solid oak

**212 059 04**

SEK\* 7.112,00 / **8.890,00**



# Tabouret Bois

Jean Prouvé, 1941

vitra.



**Seat and base:** solid wood in natural oak with oiled finish, dark stained oak with protective natural lacquer finish, or American walnut with oiled finish; connecting element: sheet metal, powder-coated (smooth) in deep black.

**Origin of wood:** oak (*Quercus robur*) from Western Europe and/or Poland; American walnut (*Juglans nigra*) from the USA.

## Tabouret Bois

	Article no.	without VAT in SEK*	with VAT in SEK*
	<b>212 026 00</b>		
natural solid oak, oiled	70	6.520,00	<b>8.150,00</b>
dark solid oak, with protective varnish	04	6.520,00	<b>8.150,00</b>
solid American walnut, oiled	75	7.912,00	<b>9.890,00</b>

# Tabouret Métallique

Jean Prouvé, 1936

380 15"



285 11 1/4"



Ø 380 15"

**Material:** bent sheet steel, powder-coated finish. Plastic glides.



## Tabouret Métallique

Prouvé Blanc Colombe (Ecrú)

**212 058 88**

SEK\* 6.232,00 / **7.790,00**



## Tabouret Métallique

Japanese red

**212 058 06**

SEK\* 6.232,00 / **7.790,00**



## Tabouret Métallique

Prouvé Bleu Marcoule

**212 058 41**

SEK\* 6.232,00 / **7.790,00**



## Tabouret Métallique

deep black

**212 058 12**

SEK\* 6.232,00 / **7.790,00**

# Visiona Stool

Verner Panton, 1970/2012

**vitra.**

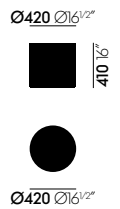

**Upholstery:** polyurethane foam with polystyrene core and polyester filling.

**Base:** MDF board with felt glides.

Visiona Stool	Article no.	without VAT in SEK*	with VAT in SEK*
	<b>210 424 00</b>		
Fabric F40		4.200,00	<b>5.250,00</b>
Fabric F60		4.680,00	<b>5.850,00</b>
Fabric F100		5.960,00	<b>7.450,00</b>

#### Fabric F40

. Laser RE

#### Fabric F60

. Hopsak  
. Twill  
. Volo

#### Fabric F100

. Tonus

# Wiggle Side Chair & Wiggle Stool

Frank Gehry, 1972



Wiggle Side Chair

**Structure:** corrugated cardboard.

**Edges:** hardboard.

## Wiggle Side Chair

	Article no.	without VAT in SEK*	with VAT in SEK*
natural	210 186 01	9.440,00	11.800,00

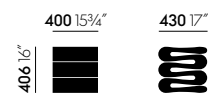

Wiggle Stool

**Structure:** corrugated cardboard.

**Edges:** hardboard.

## Wiggle Stool

	Article no.	without VAT in SEK*	with VAT in SEK*
natural	210 226 01	5.032,00	6.290,00

## Storage and partition elements



Eames Storage Unit ESU  
Charles & Ray Eames  
392



Living Tower  
Verner Panton  
393



Office and conference chairs (swivel)

Chairs

Tables

Desks

Public waiting areas

Lounge chairs and armchairs

Sofas

Coffee and side tables

Stools and benches

**Storage and partition elements**

**Accessories**

Living, dining, decorative objects, home office,  
clocks, lighting, publications

Quick Ship programme

General terms, conditions  
and information



# Eames Storage Unit ESU

Charles & Ray Eames, 1949

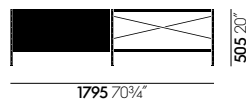

ESU Shelf - 1 HU

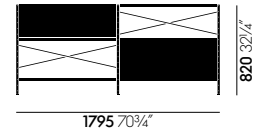
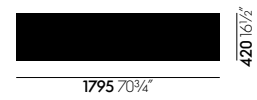

ESU Shelf - 2 HU

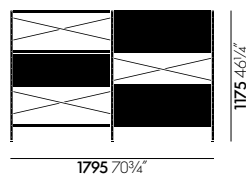
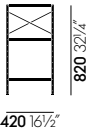

ESU Shelf - 3 HU

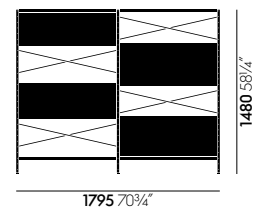

ESU Shelf - 4 HU

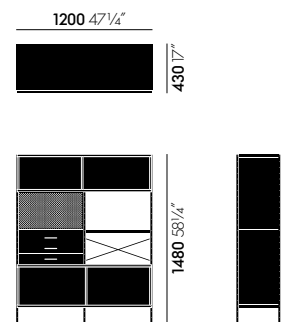
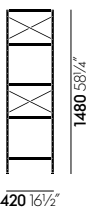

ESU Bookcase

**Metal surfaces:** black powder-coated finish.

**Shelves:** birch plywood with maple face veneer (Poland and Finland), transparent lacquer finish.

**Panels:** powder-coated aluminium.

**Legs:** individual levelling adjustment.

**Applications:** recommended for domestic use only.

## ESU Shelf

	Article no.	without VAT in SEK*	with VAT in SEK*
1 HU	213 024 11	16.760,00	20.950,00
2 HU	213 024 12	20.760,00	25.950,00
3 HU	213 024 13	25.080,00	31.350,00
4 HU	213 024 14	27.800,00	34.750,00

## ESU Bookcase

	Article no.	without VAT in SEK*	with VAT in SEK*
	213 026 11	27.960,00	34.950,00

## Publications



Vitra Design Museum  
482

Office and conference chairs (swivel)

Chairs

Tables

Desks

Public waiting areas

Lounge chairs and armchairs

Sofas

Coffee and side tables

Stools and benches

Storage and partition elements

### Accessories

Living, dining, decorative objects, home office,  
clocks, lighting and publications

Quick Ship programme

General terms, conditions  
and information



# Coat Dots

Hella Jongerius, 2013

---



Ø50 22"



50-75 2"-3"

**Balls:** beech wood, painted in various colours.

**Wall mount:** aluminium.

**Product contents:** 3 balls, incl. screws and wall plugs for installation.

**Origin of wood:** beech (*Fagus sylvatica*) from Western Europe and/or Poland.

---



## Coat Dots

set of 3, green

**201 164 02**

SEK\* 760,00 / **950,00**

---



## Coat Dots

set of 3, red

**201 164 01**

SEK\* 760,00 / **950,00**

---



## Coat Dots

set of 3, white

**201 164 03**

SEK\* 760,00 / **950,00**

---

## Corniches

Ronan &amp; Erwan Bouroullec, 2012

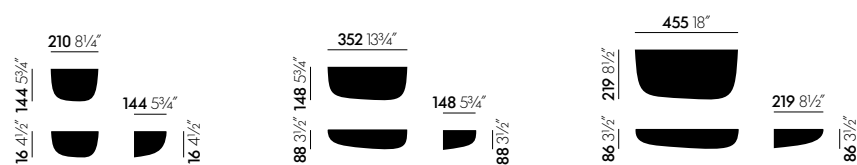

**Shell:** ASA plastic, high-gloss surface.

**Wall bracket:** polyamide.

**Packaging:** premium gift box.



### Corniches small

white

**215 060 01**

SEK\* 632,00 / 790,00



### Corniches small

orange

**215 060 04**

SEK\* 632,00 / 790,00



### Corniches small

Japanese red

**215 060 03**

SEK\* 632,00 / 790,00



### Corniches small

khaki

**215 060 06**

SEK\* 632,00 / 790,00



### Corniches small

dark grey

**215 060 05**

SEK\* 632,00 / 790,00



### Corniches small

black

**215 060 02**

SEK\* 632,00 / 790,00



### Corniches medium

white

**215 061 01**

SEK\* 872,00 / 1.090,00



### Corniches medium

orange

**215 061 04**

SEK\* 872,00 / 1.090,00



### Corniches medium

Japanese red

**215 061 03**

SEK\* 872,00 / 1.090,00



### Corniches medium

khaki

**215 061 06**

SEK\* 872,00 / 1.090,00



### Corniches medium

dark grey

**215 061 05**

SEK\* 872,00 / 1.090,00



### Corniches medium

black

**215 061 02**

SEK\* 872,00 / 1.090,00



### Corniches large

white

**215 062 01**

SEK\* 952,00 / 1.190,00



### Corniches large

orange

**215 062 04**

SEK\* 952,00 / 1.190,00



### Corniches large

Japanese red

**215 062 03**

SEK\* 952,00 / 1.190,00



### Corniches large

khaki

**215 062 06**

SEK\* 952,00 / 1.190,00



### Corniches large

dark grey

**215 062 05**

SEK\* 952,00 / 1.190,00



### Corniches large

black

**215 062 02**

SEK\* 952,00 / 1.190,00



# Hang it all

Charles & Ray Eames, 1953

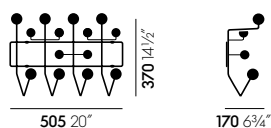

**Frame:** coated steel wire.

**Balls:** painted wood, various colours.

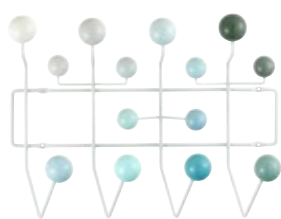

## Hang it all

White, multi-tone

**201 191 03**

SEK\* 2.680,00 / **3.350,00**

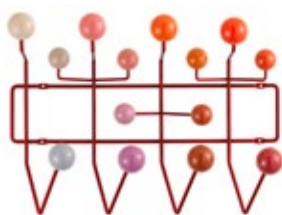

## Hang it all

Red, multi-tone

**201 191 01**

SEK\* 2.680,00 / **3.350,00**

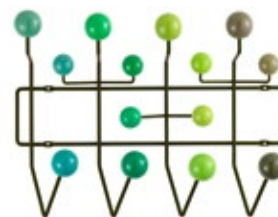

## Hang it all

Green, multi-tone

**201 191 02**

SEK\* 2.680,00 / **3.350,00**

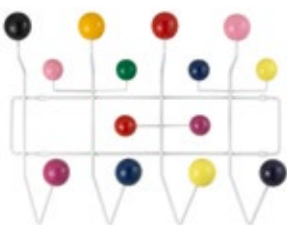

## Hang it all

White, multi-coloured

**201 190 01**

SEK\* 2.680,00 / **3.350,00**

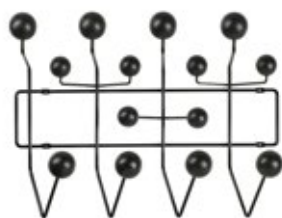

## Hang it all

Black, black ash

**201 191 04**

SEK\* 2.680,00 / **3.350,00**

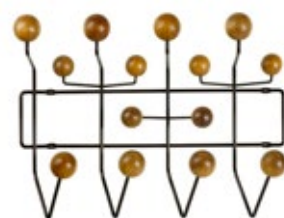

## Hang it all

Chocolate, walnut

**201 191 05**

SEK\* 2.680,00 / **3.350,00**

Limited Edition, as long as stock lasts

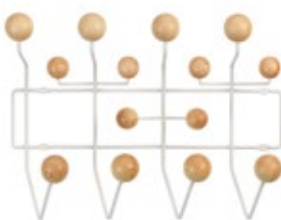

## Hang it all

White, pine

**201 191 06**

SEK\* 2.680,00 / **3.350,00**

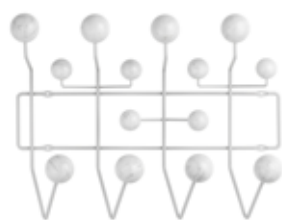

## Hang it all

Soft grey, marble

**201 191 07**

SEK\* 12.760,00 / **15.950,00**

# Rayonnage Mural

Jean Prouvé, 1936

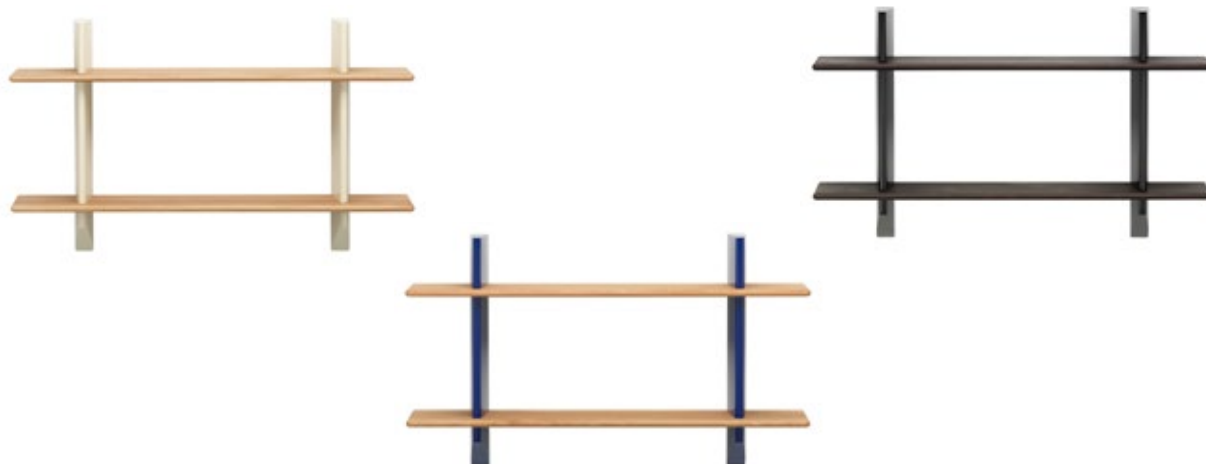

**Wall brackets:** bent sheet steel, powder-coated finish. Includes wall mounts in aluminium.

**Shelves:** solid natural oak with oiled finish or solid dark stained oak with clear protective lacquer finish.

## Dimensions

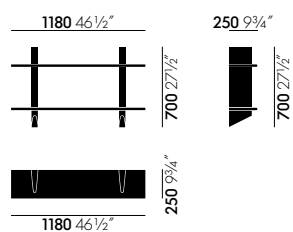

Rayonnage Mural

# Rayonnage Mural

Jean Prouvé, 1936



## Rayonnage Mural

deep black,  
dark solid oak

**213 027 02**

SEK\* 13.280,00 / **16.600,00**



## Rayonnage Mural

deep black,  
natural solid oak

**213 027 01**

SEK\* 13.280,00 / **16.600,00**



## Rayonnage Mural

Japanese red,  
dark solid oak

**213 027 12**

SEK\* 13.280,00 / **16.600,00**



## Rayonnage Mural

Japanese red,  
natural solid oak

**213 027 11**

SEK\* 13.280,00 / **16.600,00**



## Rayonnage Mural

Prouvé Blanc Colombe (Ecrú),  
dark solid oak

**213 027 22**

SEK\* 13.280,00 / **16.600,00**



## Rayonnage Mural

Prouvé Blanc Colombe (Ecrú),  
natural solid oak

**213 027 21**

SEK\* 13.280,00 / **16.600,00**



## Rayonnage Mural

Prouvé Bleu Marcoule,  
dark solid oak

**213 027 32**

SEK\* 13.280,00 / **16.600,00**



## Rayonnage Mural

Prouvé Bleu Marcoule,  
natural solid oak

**213 027 31**

SEK\* 13.280,00 / **16.600,00**



# Uten.Silo

Dorothee Becker, 1969

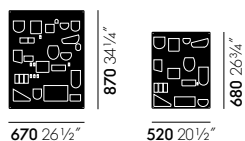

**Material:** ABS plastic.

**Hooks:** nickle-plated metal.



## Uten.Silo I

white

H 870 x W 670 x D 65 mm

**201 290 01**

SEK\* 3.560,00 / **4.450,00**



## Uten.Silo I

black

H 870 x W 670 x D 65 mm

**201 290 02**

SEK\* 3.560,00 / **4.450,00**



## Uten.Silo I

red

H 870 x W 670 x D 65 mm

**201 290 03**

SEK\* 3.560,00 / **4.450,00**



## Uten.Silo II

white

H 680 x W 520 x D 65 mm

**201 295 01**

SEK\* 2.792,00 / **3.490,00**



## Uten.Silo II

black

H 680 x W 520 x D 65 mm

**201 295 02**

SEK\* 2.792,00 / **3.490,00**



## Uten.Silo II

red

H 680 x W 520 x D 65 mm

**201 295 03**

SEK\* 2.792,00 / **3.490,00**



# Colour Block Blankets

Hella Jongerius, 2016

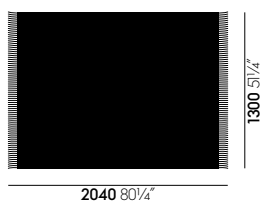

**Material:** 100% Peruvian highland wool.



## Colour Block Blankets

black-blue

2040 x 1300 mm

**201 639 03**

SEK\* 2.520,00 / **3.150,00**



## Colour Block Blankets

blue-bordeaux

2040 x 1300 mm

**201 639 01**

SEK\* 2.520,00 / **3.150,00**



## Colour Block Blankets

pink-beige

2040 x 1300 mm

**201 639 02**

SEK\* 2.520,00 / **3.150,00**

# Eames Wool Blanket

Charles & Ray Eames, 1947

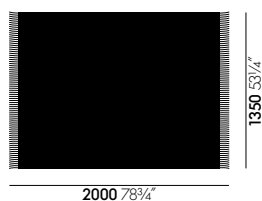

**Material:** 100% Merino lambswool, produced in a jacquard weave.

**Characteristics:** Merino lambswool is a high-quality natural fibre obtained from the first shearing of Merino lambs. It is extremely light, fine and soft to the touch while also providing optimal warmth and thermal balance.

**Quality:** working with premium natural fibres requires considerable technical know-how and manual skill. For this reason, Vitra blankets are made by a German blanket manufacturer with over 100 years of experience in fabricating products from natural fibres. Their expert hand craftsmanship ensures the high-quality execution of the designs.



## Eames Wool Blanket

black

1350 x 2000 mm

**203 529 99**

SEK\* 3.672,00 / **4.590,00**



## Eames Wool Blanket

light blue

2000 x 1350 mm

**203 529 96**

SEK\* 3.672,00 / **4.590,00**

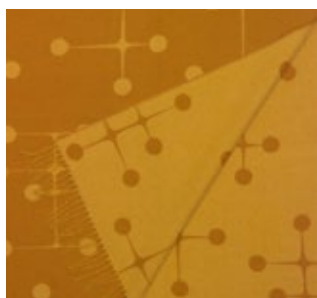

## Eames Wool Blanket

mustard

2000 x 1350 mm

**203 529 98**

SEK\* 3.672,00 / **4.590,00**



## Eames Wool Blanket

taupe

2000 x 1350 mm

**203 529 97**

SEK\* 3.672,00 / **4.590,00**



# Embroidered Pillows

Alexander Girard, 1952



**Filling:** duck half down.

**Cover fabric:** Twill, embroidered.



## Embroidered Pillows

Home Sweet Home, light grey

H 300 x W 400

**201 633 01**

SEK\* 1.992,00 / **2.490,00**



## Embroidered Pillows

Double Heart, red

H 400 x W 400

**201 633 06**

SEK\* 1.992,00 / **2.490,00**



## Embroidered Pillows

Double Heart 2, blue

H 300 x W 400

**201 633 08**

SEK\* 1.992,00 / **2.490,00**

# Graphic Print Pillows

Alexander Girard, 1961



400 15<sup>3</sup>/<sub>4</sub>"

400 x 300 mm



400 15<sup>3</sup>/<sub>4</sub>"

400 x 400 mm

**Fabric:** 100% cotton.

**Filling:** duck half down.



## Graphic Print Pillows

International Love Heart

H 400 x W 400 mm

**201 657 04**

SEK\* 840,00 / **1.050,00**



## Graphic Print Pillows

Snake, ultramarine

H 400 x W 400 mm

**201 657 02**

SEK\* 840,00 / **1.050,00**



## Graphic Print Pillows

Love Heart, crimson

H 400 x W 400 mm

**201 657 03**

SEK\* 840,00 / **1.050,00**



## Graphic Print Pillows

Eyes

H 300 x W 400 mm

**201 657 01**

SEK\* 760,00 / **950,00**



# Herringbone Pillows

Raw-Edges, 2019

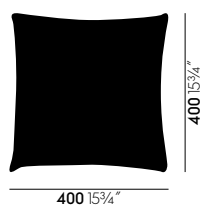

**Fabric:** 100% cotton.

**Filling:** duck half down.



**Herringbone Pillows**

blue

**201 381 04**

SEK\* 872,00 / 1.090,00



**Herringbone Pillows**

brown

**201 381 05**

SEK\* 872,00 / 1.090,00



**Herringbone Pillows**

olive

**201 381 01**

SEK\* 872,00 / 1.090,00



**Herringbone Pillows**

red

**201 381 03**

SEK\* 872,00 / 1.090,00



**Herringbone Pillows**

yellow

**201 381 02**

SEK\* 872,00 / 1.090,00

# Seat Dots

## Hella Jongerius, 2016

**Material:** firm, high-quality fleece pad, Plano fabric cover on both sides, Ø 38 cm.



### Seat Dots

parchment/cream white  
tobacco/cream white

**201 622 01**

SEK\* 472,00 / 590,00



### Seat Dots

yellow/pastel green  
parchment/cream white

**201 622 02**

SEK\* 472,00 / 590,00



### Seat Dots

cream white/sierra grey  
light grey/ice blue

**201 622 03**

SEK\* 472,00 / 590,00



### Seat Dots

pink/sierra grey  
light grey/sierra grey

**201 622 04**

SEK\* 472,00 / 590,00



### Seat Dots

coconut/forest  
forest/sierra grey

**201 622 05**

SEK\* 472,00 / 590,00



### Seat Dots

red/poppy red  
orange

**201 622 06**

SEK\* 472,00 / 590,00



### Seat Dots

red/coconut  
poppy red

**201 622 07**

SEK\* 472,00 / 590,00



### Seat Dots

classic green/forest  
classic green/cognac

**201 622 08**

SEK\* 472,00 / 590,00



### Seat Dots

mint/forest  
petrol/nero

**201 622 09**

SEK\* 472,00 / 590,00



### Seat Dots

nero/ice blue  
petrol/nero

**201 622 10**

SEK\* 472,00 / 590,00



### Seat Dots

blue/coconut  
nero/ice blue

**201 622 11**

SEK\* 472,00 / 590,00



### Seat Dots

dark grey/nero  
marron/nero

**201 622 12**

SEK\* 472,00 / 590,00



### Seat Dots

nero/cream white  
sierra grey/nero

**201 622 13**

SEK\* 472,00 / 590,00



### Seat Dots

dark red/nero  
dark red/ice blue

**201 622 14**

SEK\* 472,00 / 590,00





Eames Fiberglass & Plastic Sidechair



HAL

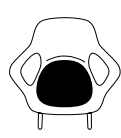

HAL Armchair

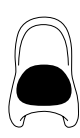

Panton & Panton Classic



EVO-C



Wire Chair

### Soft Seats type B - set of 3

	Article no.	without VAT in SEK*	with VAT in SEK*
	<b>201 626 00</b>		
<b>both sides with fabric cover</b>	<b>00</b>		
Fabric F30		1.896,00	<b>2.370,00</b>
Fabric F40		2.136,00	<b>2.670,00</b>
Fabric F60		2.376,00	<b>2.970,00</b>
Fabric F80		2.640,00	<b>3.300,00</b>
Fabric F120		3.480,00	<b>4.350,00</b>
<b>one side with non-slip coating</b>	<b>01</b>		
Fabric F30		1.896,00	<b>2.370,00</b>
Fabric F40		2.136,00	<b>2.670,00</b>
Fabric F60		2.376,00	<b>2.970,00</b>
Fabric F80		2.640,00	<b>3.300,00</b>
Fabric F120		3.480,00	<b>4.350,00</b>
Leather L20		3.960,00	<b>4.950,00</b>
Leather L50		4.536,00	<b>5.670,00</b>



All Plastic Chair



Belleville Chair



Belleville Armchair



Chaise Tout Bois



HAL

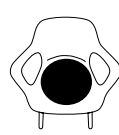

HAL Armchair



Panton & Panton Classic

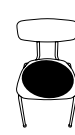

Moca



Tip Ton

### Soft Seats type C - set of 3

	Article no.	without VAT in SEK*	with VAT in SEK*
	<b>201 627 00</b>		
<b>both sides with fabric cover</b>	<b>00</b>		
Fabric F30		1.896,00	<b>2.370,00</b>
Fabric F40		2.136,00	<b>2.670,00</b>
Fabric F60		2.376,00	<b>2.970,00</b>
Fabric F80		2.640,00	<b>3.300,00</b>
Fabric F120		3.480,00	<b>4.350,00</b>
<b>one side with non-slip coating</b>	<b>01</b>		
Fabric F30		1.896,00	<b>2.370,00</b>
Fabric F40		2.136,00	<b>2.670,00</b>
Fabric F60		2.376,00	<b>2.970,00</b>
Fabric F80		2.640,00	<b>3.300,00</b>
Fabric F120		3.480,00	<b>4.350,00</b>
Leather L20		3.960,00	<b>4.950,00</b>
Leather L50		4.536,00	<b>5.670,00</b>

Fabric F30	Fabric F40	Fabric F60	Fabric F80	Fabric F120	Leather L20	Leather L50
Plano	Laser RE	Hopsak Twill Volo	Corsaro Cosy 2 Dumet Iroko 2 Tress	Credo	Leather	Leather Premium F





**Note:** available as single cushions preconfigured in a limited range of fabrics and colours for fast delivery or in sets of three with a larger choice of fabrics and colours but longer delivery times.

<b>Soft Seats type A – single cushions</b>	Non-slip coating on one side	Article no.	without VAT in SEK*	with VAT in SEK*
Plano 87 nero/cream white		201 625 01	632,00	790,00
Plano 74 sierra grey/nero		201 625 02	632,00	790,00
Plano 05 cream white/sierra grey		201 625 03	632,00	790,00
Plano 03 parchment/cream white		201 625 04	632,00	790,00
Plano 12 light grey/ice blue		201 625 05	632,00	790,00
Hopsak 24 dark grey/nero		201 625 06	792,00	990,00
Hopsak 05 dark grey		201 625 07	792,00	990,00
Hopsak 23 nero/ivory		201 625 08	792,00	990,00
Hopsak 81 ice blue/ivory		201 625 09	792,00	990,00
Hopsak 79 warm grey/ivory		201 625 10	792,00	990,00
Hopsak 20 green/ivory		201 625 75	792,00	990,00
Hopsak 17 nude/ivory		201 625 76	792,00	990,00
Hopsak 83 blue/ivory		201 625 77	792,00	990,00
Hopsak 16 yellow/ivory		201 625 78	792,00	990,00
Hopsak 18 mustard/ivory		201 625 79	792,00	990,00
Hopsak 68 pink/poppy red		201 625 80	792,00	990,00
Cosy 2 11 merino black		201 625 11	880,00	1.100,00
Cosy 2 10 classic grey		201 625 12	880,00	1.100,00
Cosy 2 01 pebble grey		201 625 13	880,00	1.100,00
Cosy 2 02 fossil		201 625 14	880,00	1.100,00
Cosy 2 12 pale blue		201 625 15	880,00	1.100,00
Dumet 33 carbon/black		201 625 16	880,00	1.100,00
Dumet 32 sierra grey melange		201 625 17	880,00	1.100,00
Dumet 28 sage/steel blue		201 625 18	880,00	1.100,00
Dumet 06 pebble melange		201 625 19	880,00	1.100,00
Dumet 01 ivory melange		201 625 20	880,00	1.100,00
Laser RE 13 stone grey		201 625 23	712,00	890,00
Laser RE 65 ice blue/cream		201 625 24	712,00	890,00
Laser RE 03 dark grey		201 625 25	712,00	890,00
Laser RE 20 ice blue/moor brown		201 625 26	712,00	890,00
Laser RE 63 warm grey/cream		201 625 27	712,00	890,00
Corsaro 13 black melange		201 625 28	880,00	1.100,00
Corsaro 12 graphite melange		201 625 29	880,00	1.100,00
Corsaro 08 sierra melange		201 625 30	880,00	1.100,00
Corsaro 01 pale blue melange		201 625 31	880,00	1.100,00
Corsaro 05 stone melange		201 625 32	880,00	1.100,00
Leather Premium F 67 asphalt		201 625 33	1.512,00	1.890,00
Leather Premium F 65 granite		201 625 34	1.512,00	1.890,00
Leather Premium F 73 clay		201 625 35	1.512,00	1.890,00

**Note:** available as single cushions preconfigured in a limited range of fabrics and colours for fast delivery or in sets of three with a larger choice of fabrics and colours but longer delivery times.

<b>Soft Seats type B – single cushions</b>	Non-slip coating on one side	Article no.	without VAT in SEK*	with VAT in SEK*
Plano 87 nero/cream white		201 626 01	632,00	790,00
Plano 74 sierra grey/nero		201 626 02	632,00	790,00
Plano 05 cream white/sierra grey		201 626 03	632,00	790,00
Plano 03 parchment/cream white		201 626 04	632,00	790,00
Plano 12 light grey/ice blue		201 626 05	632,00	790,00
<hr/>				
Hopsak 24 dark grey/nero		201 626 06	792,00	990,00
Hopsak 05 dark grey		201 626 07	792,00	990,00
Hopsak 23 nero/ivory		201 626 08	792,00	990,00
Hopsak 81 ice blue/ivory		201 626 09	792,00	990,00
Hopsak 79 warm grey/ivory		201 626 10	792,00	990,00
Hopsak 20 green/ivory		201 626 75	792,00	990,00
Hopsak 17 nude/ivory		201 626 76	792,00	990,00
Hopsak 83 blue/ivory		201 626 77	792,00	990,00
Hopsak 16 yellow/ivory		201 626 78	792,00	990,00
Hopsak 18 mustard/ivory		201 626 79	792,00	990,00
Hopsak 68 pink/poppy red		201 626 80	792,00	990,00
<hr/>				
Cosy 2 11 merino black		201 626 11	880,00	1.100,00
Cosy 2 10 classic grey		201 626 12	880,00	1.100,00
Cosy 2 01 pebble grey		201 626 13	880,00	1.100,00
Cosy 2 02 fossil		201 626 14	880,00	1.100,00
Cosy 2 12 pale blue		201 626 15	880,00	1.100,00
<hr/>				
Dumet 33 carbon/black		201 626 16	880,00	1.100,00
Dumet 32 sierra grey melange		201 626 17	880,00	1.100,00
Dumet 28 sage/steel blue		201 626 18	880,00	1.100,00
Dumet 06 pebble melange		201 626 19	880,00	1.100,00
Dumet 01 ivory melange		201 626 20	880,00	1.100,00
<hr/>				
Laser RE 13 stone grey		201 626 23	712,00	890,00
Laser RE 65 ice blue/cream		201 626 24	712,00	890,00
Laser RE 03 dark grey		201 626 25	712,00	890,00
Laser RE 20 ice blue/moor brown		201 626 26	712,00	890,00
Laser RE 63 warm grey/cream		201 626 27	712,00	890,00
<hr/>				
Corsaro 13 black melange		201 626 28	880,00	1.100,00
Corsaro 12 graphite melange		201 626 29	880,00	1.100,00
Corsaro 08 sierra melange		201 626 30	880,00	1.100,00
Corsaro 01 pale blue melange		201 626 31	880,00	1.100,00
Corsaro 05 stone melange		201 626 32	880,00	1.100,00
<hr/>				
Leather Premium F 67 asphalt		201 626 33	1.512,00	1.890,00
Leather Premium F 65 granite		201 626 34	1.512,00	1.890,00
Leather Premium F 73 clay		201 626 35	1.512,00	1.890,00



**Note:** available as single cushions preconfigured in a limited range of fabrics and colours for fast delivery or in sets of three with a larger choice of fabrics and colours but longer delivery times.

Soft Seats type C – single cushions	Non-slip coating on one side	Article no.	without VAT in SEK*	with VAT in SEK*
Plano 87 nero/cream white		201 627 01	632,00	790,00
Plano 74 sierra grey/nero		201 627 02	632,00	790,00
Plano 05 cream white/sierra grey		201 627 03	632,00	790,00
Plano 03 parchment/cream white		201 627 04	632,00	790,00
Plano 12 light grey/ice blue		201 627 05	632,00	790,00
Hopsak 24 dark grey/nero		201 627 06	792,00	990,00
Hopsak 05 dark grey		201 627 07	792,00	990,00
Hopsak 23 nero/ivory		201 627 08	792,00	990,00
Hopsak 81 ice blue/ivory		201 627 09	792,00	990,00
Hopsak 79 warm grey/ivory		201 627 10	792,00	990,00
Hopsak 20 green/ivory		201 627 75	792,00	990,00
Hopsak 17 nude/ivory		201 627 76	792,00	990,00
Hopsak 83 blue/ivory		201 627 77	792,00	990,00
Hopsak 16 yellow/ivory		201 627 78	792,00	990,00
Hopsak 18 mustard/ivory		201 627 79	792,00	990,00
Hopsak 68 pink/poppy red		201 627 80	792,00	990,00
Cosy 2 11 merino black		201 627 11	880,00	1.100,00
Cosy 2 10 classic grey		201 627 12	880,00	1.100,00
Cosy 2 01 pebble grey		201 627 13	880,00	1.100,00
Cosy 2 02 fossil		201 627 14	880,00	1.100,00
Cosy 2 12 pale blue		201 627 15	880,00	1.100,00
Dumet 33 carbon/black		201 627 16	880,00	1.100,00
Dumet 32 sierra grey melange		201 627 17	880,00	1.100,00
Dumet 28 sage/steel blue		201 627 18	880,00	1.100,00
Dumet 06 pebble melange		201 627 19	880,00	1.100,00
Dumet 01 ivory melange		201 627 20	880,00	1.100,00
Laser RE 13 stone grey		201 627 23	712,00	890,00
Laser RE 65 ice blue/cream		201 627 24	712,00	890,00
Laser RE 03 dark grey		201 627 25	712,00	890,00
Laser RE 20 ice blue/moor brown		201 627 26	712,00	890,00
Laser RE 63 warm grey/cream		201 627 27	712,00	890,00
Corsaro 13 black melange		201 627 28	880,00	1.100,00
Corsaro 12 graphite melange		201 627 29	880,00	1.100,00
Corsaro 08 sierra melange		201 627 30	880,00	1.100,00
Corsaro 01 pale blue melange		201 627 31	880,00	1.100,00
Corsaro 05 stone melange		201 627 32	880,00	1.100,00
Leather Premium F 67 asphalt		201 627 33	1.512,00	1.890,00
Leather Premium F 65 granite		201 627 34	1.512,00	1.890,00
Leather Premium F 73 clay		201 627 35	1.512,00	1.890,00

# Soft Seats Outdoor

## 2023

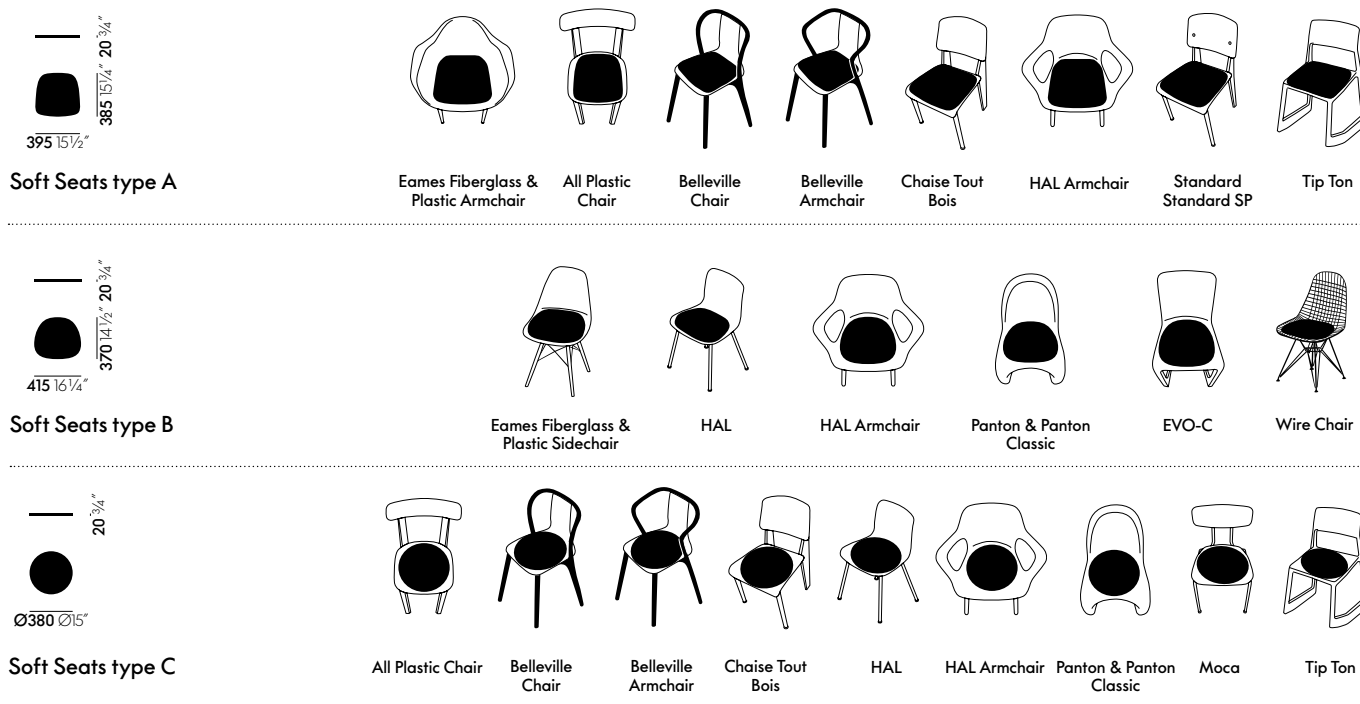

### Materials

**Upholstery:** padding made of polyurethane foam for outdoor use, 2-cm thick (Oeko-Tex).

**Cover:** water-repellent outdoor fabric, with zip fastener (always in black), removable. Cover can be washed at 30 degrees.

**Note:** always with non-slip fabric on reverse side.

### Soft Seats Outdoor type A - single cushions

	Article no.	without VAT in SEK*	with VAT in SEK*
Simmons 53 white/steel blue	201 625 69	960,00	1.200,00
Simmons 55 grey/white	201 625 70	960,00	1.200,00
Simmons 61 grey	201 625 71	960,00	1.200,00

### Soft Seats Outdoor type B - single cushions

	Article no.	without VAT in SEK*	with VAT in SEK*
Simmons 53 white/steel blue	201 626 69	960,00	1.200,00
Simmons 55 grey/white	201 626 70	960,00	1.200,00
Simmons 61 grey	201 626 71	960,00	1.200,00

### Soft Seats Outdoor type C - single cushions

	Article no.	without VAT in SEK*	with VAT in SEK*
Simmons 53 white/steel blue	201 627 69	960,00	1.200,00
Simmons 55 grey/white	201 627 70	960,00	1.200,00
Simmons 61 grey	201 627 71	960,00	1.200,00





**Material:** polycarbonate.

**Equipment:** wireless charger, 2 power connections, 2 USB-A connections, 1 USB-C connection.

**Cable length:** 1.5 metres.

Ampi		Article no.	without VAT in SEK*	with VAT in SEK*
basic dark	ELE01: DE, AT, NL, ES norm	<b>201 394 01</b>	1.840,00	<b>2.300,00</b>
soft grey	ELE01: DE, AT, NL, ES norm	<b>201 394 02</b>	1.840,00	<b>2.300,00</b>

GST18 plug		Article no.	without VAT in SEK*	with VAT in SEK*
Adapter cable 0.5m	EU standard	<b>201 403 01</b>	224,00	<b>280,00</b>



# Chap

Konstantin Grcic, 2021

vitra.



**Material:** recycled polypropylene, 100% recyclable.



**Chap**  
deep black RE  
**201 393 01**  
SEK\* 840,00 / 1.050,00



**Chap**  
brick RE  
**201 393 04**  
SEK\* 840,00 / 1.050,00



**Chap**  
dark grey RE  
**201 393 02**  
SEK\* 840,00 / 1.050,00



**Chap**  
sea blue RE  
**201 393 03**  
SEK\* 840,00 / 1.050,00



**Chap Tray**  
deep black RE  
**201 398 01**  
SEK\* 280,00 / 350,00



**Chap Tray**  
brick RE  
**201 398 04**  
SEK\* 280,00 / 350,00



**Chap Tray**  
dark grey RE  
**201 398 02**  
SEK\* 280,00 / 350,00



**Chap Tray**  
sea blue RE  
**201 398 03**  
SEK\* 280,00 / 350,00



# Magnet Dots

Hella Jongerius, 2016

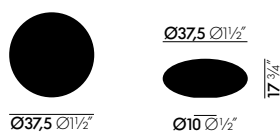

**Dots:** dyed-through polypropylene.

**Magnet:** inset ferrite magnet. One magnet can hold up to 5 sheets of paper (DIN A4).

**Package contents:** 5 Magnet Dots per set.



## Magnet Dots

set of 5, bright

**215 105 03**

SEK\* 232,00 / **290,00**



## Magnet Dots

set of 5, dark

**215 105 04**

SEK\* 232,00 / **290,00**



## Magnet Dots

set of 5, green

**215 105 01**

SEK\* 232,00 / **290,00**



## Magnet Dots

set of 5, red

**215 105 02**

SEK\* 232,00 / **290,00**



# Akari Light Sculptures

Isamu Noguchi, 1951



## Akari Light Sculptures

**Lampshades:** washi paper, some partially painted. Some models with end pieces in wood/bamboo.

**Structure:** bamboo/steel wire.

**Legs:** painted steel wire.

**Light source:** 4W LED

**Socket:** E27

**Dimmability:** not dimmable.

**Kelvin:** 2700 K (warm white).

**Plug:** Euro flat, 2-pin (type C plug).

**Max. watt:** 12W

**Energy efficiency:** E

**Cable length for table lamps:** 130 cm.

**Cable length for floor lamps:** 300 cm.

**Cable length for ceiling lamps:** 220 cm.

# Akari Light Sculptures

Isamu Noguchi, 1951

vitra.



**1A**  
H 430 x W 250 x D 250  
**201 570 01**  
SEK\* 2.760,00 / **3.450,00**



**1AD**  
H 430 x W 260 x D 260  
**201 570 02**  
SEK\* 3.192,00 / **3.990,00**



**1AG**  
H 430 x W 260 x D 260  
**201 571 01**  
SEK\* 3.192,00 / **3.990,00**



**1AY**  
H 430 x W 260 x D 260  
**201 570 03**  
SEK\* 3.192,00 / **3.990,00**



**1N**  
H 390 x W 250 x D 250  
**201 572 01**  
SEK\* 2.760,00 / **3.450,00**



**3X**  
H 380 x W 230 x D 230  
**201 578 01**  
SEK\* 2.712,00 / **3.390,00**



**20N**  
H 630 x W 420 x D 420  
**201 574 01**  
SEK\* 4.200,00 / **5.250,00**



**24N**  
H 580 x W 400 x D 400  
**201 658 01**  
SEK\* 5.560,00 / **6.950,00**



**UF1-H**  
H 510 x W 200 x D 200  
**201 546 01**  
SEK\* 4.200,00 / **5.250,00**



**3A**  
H 560 x W 280 x D 280  
**201 577 01**  
SEK\* 5.480,00 / **6.850,00**



**3AD**  
H 560 x W 250 x D 250  
**201 585 01**  
SEK\* 5.672,00 / **7.090,00**



**9AD**  
H 620 x W 440 x D 440  
**201 586 01**  
SEK\* 5.960,00 / **7.450,00**



**7A**  
H 630 x W 300 x D 300  
**201 648 01**  
SEK\* 5.960,00 / **7.450,00**



**9A**  
H 620 x W 440 x D 440  
**201 649 01**  
SEK\* 5.960,00 / **7.450,00**



**YA2**  
H 510 x W 360 x D 360  
**201 593 01**  
SEK\* 3.432,00 / **4.290,00**

All dimensions in mm.  
Prices excl./incl. VAT

\* recommended retail price

1/2023 (SE-EN)

475



# Akari Light Sculptures

Isamu Noguchi, 1951

vitra.



**UF4-33N**

H 1900 x W 470 x D 470

**201 559 01**

SEK\* 17.400,00 / **21.750,00**



**UF4-L8**

H 1880 x W 410 x D 410

**201 562 01**

SEK\* 16.920,00 / **21.150,00**



**UF4-L10**

H 1930 x W 480 x D 480

**201 560 01**

SEK\* 17.640,00 / **22.050,00**



**BB3-55DD**

H 1850 x W 530 x D 530

**201 537 01**

SEK\* 20.120,00 / **25.150,00**



**BB3-33S**

H 1700 x W 750 x D 250

**201 536 01**

SEK\* 23.400,00 / **29.250,00**



**UF3-Q**

H 1450 x W 560 x D 560

**201 557 01**

SEK\* 10.200,00 / **12.750,00**



**10A**

H 1230 x W 530 x D 530

**201 530 01**

SEK\* 6.872,00 / **8.590,00**



**13A**

H 1360 x W 490 x D 490

**201 591 01**

SEK\* 8.760,00 / **10.950,00**



**14A**

H 1580 x W 510 x D 510

**201 531 01**

SEK\* 10.040,00 / **12.550,00**



**25N**

H 1170 x W 830 x D 830

**201 659 01**

SEK\* 16.920,00 / **21.150,00**

# Akari Light Sculptures

Isamu Noguchi, 1951



**45A**  
H 450 x W 450 x D 450  
**201 508 01**  
SEK\* 3.192,00 / **3.990,00**



**55A**  
H 550 x W 550 x D 550  
**201 509 01**  
SEK\* 3.832,00 / **4.790,00**



**75A**  
H 750 x W 750 x D 750  
**201 510 01**  
SEK\* 10.520,00 / **13.150,00**



**120A**  
H 1200 x W 1200 x D 1200  
**201 511 01**  
SEK\* 27.000,00 / **33.750,00**



**55D**  
H 520 x W 550 x D 550  
**201 515 01**  
SEK\* 3.512,00 / **4.390,00**



**75D**  
H 690 x W 740 x D 740  
**201 516 01**  
SEK\* 8.440,00 / **10.550,00**



**26A**  
H 250 x W 450 x D 450  
**201 507 01**  
SEK\* 3.192,00 / **3.990,00**



**21A**  
H 280 x W 650 x D 650  
**201 506 01**  
SEK\* 5.160,00 / **6.450,00**



**15A**  
H 330 x W 880 x D 880  
**201 505 01**  
SEK\* 9.160,00 / **11.450,00**



**50EN**  
H 250 x W 500 x D 500  
**201 518 01**  
SEK\* 3.832,00 / **4.790,00**



**70EN**  
H 330 x W 700 x D 700  
**201 519 01**  
SEK\* 5.912,00 / **7.390,00**



**23A**  
H 700 x W 320 x D 320  
**201 583 01**  
SEK\* 3.672,00 / **4.590,00**



**45X**  
H 430 x W 430 x D 430  
**201 525 01**  
SEK\* 3.912,00 / **4.890,00**



**33N**  
H 1600 x W 470 x D 470  
**201 522 01**  
SEK\* 8.680,00 / **10.850,00**



**E**  
H 2950 x W 480 x D 480  
**201 527 01**  
SEK\* 21.960,00 / **27.450,00**



**16A**  
H 280 x W 520 x D 480  
**201 650 01**  
SEK\* 5.512,00 / **6.890,00**



**YP1**  
H 380 x W 500 x D 500  
**201 592 01**  
SEK\* 4.600,00 / **5.750,00**

All dimensions in mm.  
Prices excl./incl. VAT



## Lampe de Bureau

Jean Prouvé, 1930

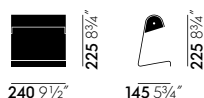

**Material:** powder-coated sheet steel, 1 bulb included.

**Socket:** E14.

**Light source:** Osram Candle, frosted.

**Dimmability:** no dimmer.

**Kelvin:** 2700 K (warm white).

**Plug:** Euro flat 2-pin (type C plug), UK 3-pin (type G plug) or US 2-pin (type A plug).

**Cable length:** from cable outlet to switch 50 cm, from switch to plug 200 cm.

**Max. watt:** 12 W.

**Energy efficiency:** F

## Lampe de Bureau

		Article no.	without VAT in SEK*	with VAT in SEK*
Japanese red	220-240 V, 50/60 Hz, Plug Type C	201 264 01	2.632,00	3.290,00
deep black	220-240 V, 50/60 Hz, Plug Type C	201 264 02	2.632,00	3.290,00
mint	220-240 V, 50/60 Hz, Plug Type C	201 264 03	2.632,00	3.290,00
Prouvé Blanc Colombe (Ecrú)	220-240 V, 50/60 Hz, Plug Type C	201 264 04	2.632,00	3.290,00
Prouvé Bleu Marcoule	220-240 V, 50/60 Hz, Plug Type C	201 264 05	2.632,00	3.290,00

# Potence

Jean Prouvé, 1947/1950

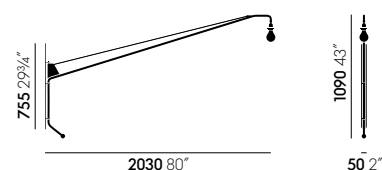
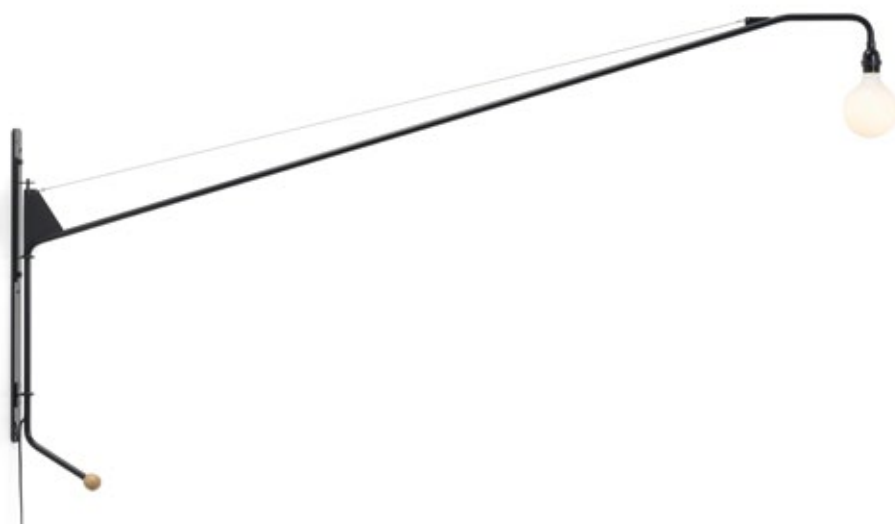

**Material:** powder-coated tubular steel, oakwood handle, cord dimmer, 1 bulb included.

**Socket:** E27.

**Light source:** Porcelain III, LED Globe 125 mm.

**Dimmability:** dimmer.

**Kelvin:** 2700 K (warm white).

**Plug:** Euro flat 2-pin (type C plug), UK 3-pin (type G plug) or US 2-pin (type A plug).

**Cable length:** from cable outlet to dimmer 75 cm, from dimmer to plug 300 cm.

**Max. watt:** 12 W.

**Energy efficiency:** F

Potence		Article no.	without VAT in SEK*	with VAT in SEK*
deep black	220-240 V, 50/60 Hz, Plug Type C	412 399 00	12.760,00	15.950,00
Prouvé Blanc Colombe (Ecrú)	220-240V, 50/60 Hz, Plug Type C	412 399 02	12.760,00	15.950,00



# Petite Potence

Jean Prouvé, 1947

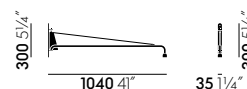

**Material:** powder-coated tubular steel, cord dimmer, 1 bulb included.

**Socket:** E27.

**Light source:** Porcelain II, LED Globe 80 mm.

**Dimmability:** dimmer.

**Kelvin:** 2700 K (warm white).

**Plug:** Euro flat 2-pin (type C plug), UK 3-pin (type G plug) or US 2-pin (type A plug).

**Cable length:** from cable outlet to dimmer 95 cm, from dimmer to plug 300 cm.

**Max. watt:** 12 W.

**Energy efficiency:** F

Petite Potence		Article no.	without VAT in SEK*	with VAT in SEK*
Japanese red	220-240 V, 50/60 Hz, Plug Type C	201 265 01	8.600,00	10.750,00
deep black	220-240 V, 50/60 Hz, Plug Type C	201 265 02	8.600,00	10.750,00
Prouvé Blanc Colombe (Ecrú)	220-240V, 50/60 Hz, Plug Type C	201 265 03	8.600,00	10.750,00
Prouvé Bleu Marcoule	220-240V, 50/60Hz, Plug Type C	201 265 04	8.600,00	10.750,00

# Abat-Jour Conique

Jean Prouvé, 1947

vitra.



Potence with Abat-Jour Conique



Petite Potence with Abat-Jour Conique



- **Material:** steel wire, powder-coated. Fabric cover made of brushed cotton in white, with plastic backing.
- **Product contents:** lampshade and light bulb.
- **Light bulb type E27:** LED Superstar Classic, A75, dimmable, E27
- **Energy efficiency:** F

## Abat-Jour Conique

Abat-Jour Conique (E27)

Article no.	without VAT in SEK*	with VAT in SEK*
201 297 01	3.112,00	3.890,00





## Quick Ship programme



DSR Fiberglass  
Charles & Ray Eames  
488



DSW Fiberglass  
Charles & Ray Eames  
488



DAR  
Charles & Ray Eames  
489



DAW  
Charles & Ray Eames  
489



DSR  
Charles & Ray Eames  
490



DSW  
Charles & Ray Eames  
490



Panton Chair  
Verner Panton  
491



AM Chair  
Alberto Meda  
491



ID Mesh  
Antonio Citterio  
492



ID Soft  
Antonio Citterio  
492



Physix  
Alberto Meda  
493



Rookie  
Konstantin Grcic  
493

The chapter 'Quick Ship programme' lists products available with a fast delivery. Their article numbers begin with 'QS'.

Vitra delivers standard order quantities from stock. Items sent with standard packing are dispatched in the next scheduled shipment, involving no extra cost.

Items can be ordered in the Online Sales Configurator <https://salesconfigurator.vitra.com/> provided stocks are available, and the respective delivery times can be checked. However, if the daily quota is exhausted, no delivery times will be shown.

Other versions, special orders and stock orders are not available through the Quick Ship programme.

All products in the Quick Ship programme are identified in the price list by a lorry symbol. 

## Office and conference chairs (swivel)

Chairs

Tables

Desks

Public waiting areas

Lounge chairs and armchairs

Sofas

Coffee and side tables

Stools and benches

Storage and partition elements

Accessories

Living, dining, decorative objects, home office, clocks, lighting, publications

Quick Ship programme

General terms, conditions and information





# Quick Ship programme

## Various Designers

**vitra.**

### Dining Chairs

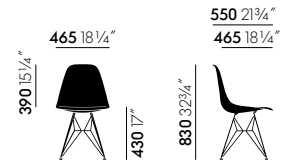

All measurements are pursuant to EN 1335-1:2000

More detailed information is found in the chapter 'Explanation of measurements'.

<b>Eames Fiberglass Side Chair DSR, seat shell in colour Eames Elephant Hide Grey</b>		Article no.	without VAT in SEK*	with VAT in SEK*
Base powder-coated in basic dark (smooth)	Felt glides for hard floors in basic dark	QS4 040 0A	5.928,00	7.410,00
Base powder-coated in basic dark (smooth)	Carpet glides in basic dark	QS4 040 0C	5.928,00	7.410,00

<b>Eames Fiberglass Side Chair DSR, shell colour Eames Sea Foam Green</b>		Article no.	without VAT in SEK*	with VAT in SEK*
Base powder-coated in basic dark (smooth)	Felt glides for hard floors in basic dark	QS4 040 0B	5.928,00	7.410,00
Base powder-coated in basic dark (smooth)	Carpet glides in basic dark	QS4 040 0D	5.928,00	7.410,00

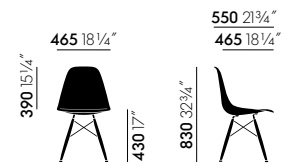

All measurements are pursuant to EN 1335-1:2000

More detailed information is found in the chapter 'Explanation of measurements'.

<b>Eames Fiberglass Side Chair DSW, shell colour Eames Elephant Hide Grey</b>		Article no.	without VAT in SEK*	with VAT in SEK*
Base in black maple	Felt glides for hard floors in basic dark	QS4 040 5A	7.400,00	9.250,00
Base in black maple	Carpet glides in basic dark	QS4 040 5E	7.400,00	9.250,00
Base in dark maple	Felt glides for hard floors in basic dark	QS4 040 5B	7.400,00	9.250,00
Base in dark maple	Carpet glides in basic dark	QS4 040 5F	7.400,00	9.250,00

<b>Eames Fiberglass Side Chair DSW, shell colour Eames Sea Foam Green</b>		Article no.	without VAT in SEK*	with VAT in SEK*
Base in black maple	Felt glides for hard floors in basic dark	QS4 040 5C	7.400,00	9.250,00
Base in black maple	Carpet glides in basic dark	QS4 040 5G	7.400,00	9.250,00
Base in dark maple	Felt glides for hard floors in basic dark	QS4 040 5D	7.400,00	9.250,00
Base in dark maple	Carpet glides in basic dark	QS4 040 5H	7.400,00	9.250,00



# Quick Ship programme

## Various Designers

**vitra.**

### Dining Chairs

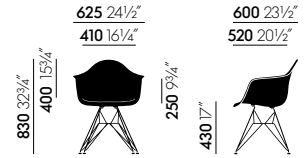

All measurements are pursuant to EN 1335-1:2000

More detailed information is found in the chapter 'Explanation of measurements'.

#### Eames Plastic Armchair DAR, shell colour white

		Article no.	without VAT in SEK*	with VAT in SEK*
chrome-plated base	Felt glides for hard floors in basic dark	QS4 032 0A	4.088,00	5.110,00
Chrome-plated base	Carpet glides in basic dark	QS4 032 0C	4.088,00	5.110,00

#### Eames Plastic Armchair DAR, shell colour deep black

		Article no.	without VAT in SEK*	with VAT in SEK*
chrome-plated base	Felt glides for hard floors in basic dark	QS4 032 0B	4.088,00	5.110,00
chrome-plated base	Carpet glides in basic dark	QS4 032 0D	4.088,00	5.110,00

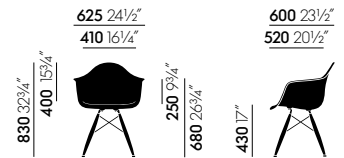

All measurements are pursuant to EN 1335-1:2000

More detailed information is found in the chapter 'Explanation of measurements'.

#### Eames Plastic Armchair DAW, shell colour white

		Article no.	without VAT in SEK*	with VAT in SEK*
Base in honey-toned ash	Felt glides for hard floors in basic dark	QS4 032 5A	5.896,00	7.370,00
Base in honey-toned ash	Carpet glides in basic dark	QS4 032 5F	5.896,00	7.370,00
Base in golden maple	Felt glides for hard floors in basic dark	QS4 032 5B	5.560,00	6.950,00
Base in golden maple	Carpet glides in basic dark	QS4 032 5E	5.560,00	6.950,00

#### Eames Plastic Armchair DAW, shell colour deep black

		Article no.	without VAT in SEK*	with VAT in SEK*
Base in honey-toned ash	Felt glides for hard floors in basic dark	QS4 032 5C	5.896,00	7.370,00
Base in honey-toned ash	Carpet glides in basic dark	QS4 032 5H	5.896,00	7.370,00
Base in golden maple	Felt glides for hard floors in basic dark	QS4 032 5D	5.560,00	6.950,00
Base in golden maple	Carpet glides in basic dark	QS4 032 5G	5.560,00	6.950,00





# Quick Ship programme

## Various Designers

**vitra.**

### Dining Chairs



All measurements are pursuant to EN 1335-1:2000

More detailed information is found in the chapter 'Explanation of measurements'.

#### Eames Plastic Side Chair DSR, shell colour white

		Article no.	without VAT in SEK*	with VAT in SEK*
Chrome-plated base	Felt glides for hard floors in basic dark	QS4 030 0A	2.952,00	3.690,00
Chrome-plated base	Carpet glides in basic dark	QS4 030 0C	2.952,00	3.690,00

#### Eames Plastic Side Chair DSR, shell colour deep black

		Article no.	without VAT in SEK*	with VAT in SEK*
Chrome-plated base	Felt glides for hard floors in basic dark	QS4 030 0B	2.952,00	3.690,00
Chrome-plated base	Carpet glides in basic dark	QS4 030 0D	2.952,00	3.690,00

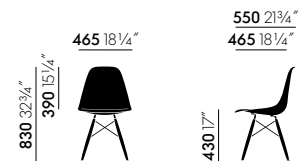

All measurements are pursuant to EN 1335-1:2000

More detailed information is found in the chapter 'Explanation of measurements'.

#### Eames Plastic Side Chair DSW, shell colour white

		Article no.	without VAT in SEK*	with VAT in SEK*
Base in honey-toned ash	Felt glides for hard floors in basic dark	QS4 030 5B	4.760,00	5.950,00
Base in honey-toned ash	Carpet glides in basic dark	QS4 030 5F	4.760,00	5.950,00
Base in golden maple	Felt glides for hard floors in basic dark	QS4 030 5A	4.424,00	5.530,00
Base in golden maple	Carpet glides in basic dark	QS4 030 5E	4.424,00	5.530,00

#### Eames Plastic Side Chair DSW, shell colour deep black

		Article no.	without VAT in SEK*	with VAT in SEK*
Base in honey-toned ash	Felt glides for hard floors in basic dark	QS4 030 5D	4.760,00	5.950,00
Base in honey-toned ash	Carpet glides in basic dark	QS4 030 5H	4.760,00	5.950,00
Base in golden maple	Felt glides for hard floors in basic dark	QS4 030 5C	4.424,00	5.530,00
Base in golden maple	Carpet glides in basic dark	QS4 030 5G	4.424,00	5.530,00



# Quick Ship programme

## Various Designers

**vitra.**

### Dining Chairs

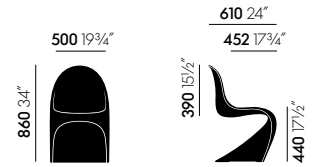

All measurements are pursuant to EN 1335-1:2000  
More detailed information is found in the chapter 'Explanation of measurements'.

### Panton Chair

	Article no.	without VAT in SEK*	with VAT in SEK*
Chair in white	QS4 003 5A	3.032,00	3.790,00

### Task Chairs

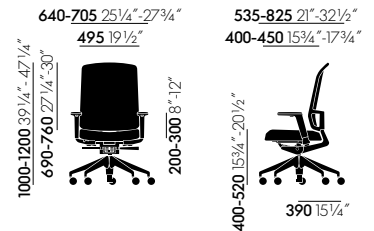

All measurements are pursuant to EN 1335-1:2000  
More detailed information is found in the chapter 'Explanation of measurements'.

### AM Chair, seat cover in Plano nero, back cover in LightNet black

	Article no.	without VAT in SEK*	with VAT in SEK*
Hard braked castors for carpet	QS1 705 0A	8.000,00	10.000,00
Soft braked castors for hard floors	QS1 705 0B	8.000,00	10.000,00

ProMotion mechanism with seat depth adjustment, no forward tilt, armrests and back frame in deep black, 2D-armrests, plastic base in deep black

ProMotion mechanism with seat depth adjustment, no forward tilt, armrests and back frame in deep black, 2D-armrests, plastic base in deep black





# Quick Ship programme

## Various Designers

**vitra.**

### Task Chairs

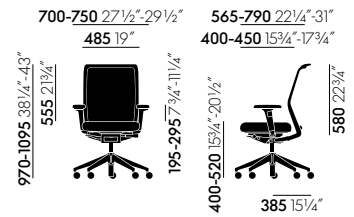

All measurements are pursuant to EN 1335-1:2000  
More detailed information is found in the chapter 'Explanation of measurements'.

ID Mesh, seat cover in Plano nero, back cover in Diamond Mesh nero		Article no.	without VAT in SEK*	with VAT in SEK*
Hard braked castors for carpet	FlowMotion mechanism with forward tilt and seat depth adjustment; frame in colour basic dark; 2D armrests F, polished aluminium; five-star base in plastic, basic dark	QS3 140 1A	9.376,00	11.720,00
Soft braked castors for hard floors	FlowMotion mechanism with forward tilt, with seat depth adjustment; frame in colour basic dark; 2D armrests F, polished aluminium; five-star base in plastic, basic dark	QS3 140 1B	9.376,00	11.720,00

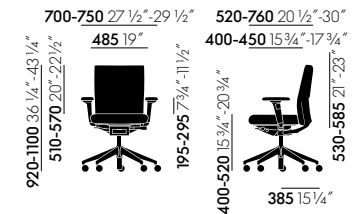

All measurements are pursuant to EN 1335-1:2000  
More detailed information is found in the chapter 'Explanation of measurements'.

ID Soft, seat and backrest covers in Plano nero		Article no.	without VAT in SEK*	with VAT in SEK*
Hard braked castors for carpet	FlowMotion mechanism with forward tilt and seat depth adjustment; frame in colour basic dark; 2D armrests F, polished aluminium; five-star base in plastic, basic dark	QS3 140 2A	10.360,00	12.950,00
Soft braked castors for hard floors	FlowMotion mechanism with forward tilt and seat depth adjustment; frame in colour basic dark; 2D armrests F, polished aluminium; five-star base in plastic, basic dark	QS3 140 2B	10.360,00	12.950,00



# Quick Ship programme

## Various Designers

**vitra.**

### Task Chairs

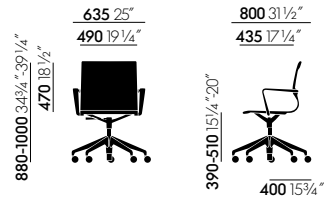

All measurements are pursuant to EN 1335-1:2000  
More detailed information is found in the chapter 'Explanation of measurements'.

#### Physix, cover material TrioKnit, black pearl

		Article no.	without VAT in SEK*	with VAT in SEK*
<b>Hard braked castors for carpet</b>	Five-star aluminium base in deep black, frame and mechanical unit in deep black	<b>QS1 721 0A</b>	10.272,00	<b>12.840,00</b>
<b>Soft braked castors for hard floors</b>	Five-star aluminium base in deep black, frame and mechanical unit in deep black	<b>QS1 721 0B</b>	10.272,00	<b>12.840,00</b>

#### Physix, cover material TrioKnit, silver grey

		Article no.	without VAT in SEK*	with VAT in SEK*
<b>Hard braked castors for carpet</b>	Five-star aluminium base in soft grey, frame and mechanical unit in soft grey	<b>QS1 721 0E</b>	10.272,00	<b>12.840,00</b>
<b>Soft braked castors for hard floors</b>	Five-star aluminium base in soft grey, frame and mechanical unit in soft grey	<b>QS1 721 0F</b>	10.272,00	<b>12.840,00</b>

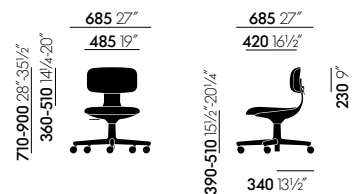

All measurements are pursuant to EN 1335-1:2000  
More detailed information is found in the chapter 'Explanation of measurements'.

#### Rookie, cover material Plano, nero

		Article no.	without VAT in SEK*	with VAT in SEK*
<b>Hard braked castors for carpet</b>	Shell colour deep black, five-star plastic base in deep black	<b>QS1 901 1B</b>	4.408,00	<b>5.510,00</b>
<b>Soft braked castors for hard floors</b>	Shell colour deep black, five-star plastic base in deep black	<b>QS1 901 1A</b>	4.408,00	<b>5.510,00</b>

#### Rookie, cover material Plano, cream white/sierra grey

		Article no.	without VAT in SEK*	with VAT in SEK*
<b>Hard braked castors for carpet</b>	Shell colour soft grey, five-star plastic base in soft grey	<b>QS1 901 1D</b>	4.408,00	<b>5.510,00</b>
<b>Soft braked castors for hard floors</b>	Shell colour soft grey, five-star plastic base in soft grey	<b>QS1 901 1C</b>	4.408,00	<b>5.510,00</b>







Office and conference chairs (swivel)

Chairs

Tables

- 497 Overview of cover materials
- 500 Explanation of measurements
- 502 Distribution rights
- 503 General Conditions of Sale and Delivery

Desks

Public waiting areas

Lounge chairs and armchairs

Sofas

Coffee and side tables

Stools and benches

Storage and partition elements

Accessories

Living, dining, decorative objects, home office,  
clocks, lighting, publications

Quick Ship programme

General terms, conditions  
and information





# Overview of cover materials

## Textiles with a price group

Fabric orders in full metres only.

Price group	without VAT in SEK / lin. m	Article no.	Material	Width	Weight	
F2o	950.00	Nova	62304800	100% polyester	142 cm +/- 2 cm	400 g/m <sup>2</sup>
		Vinyl Valencia	62308900	22% polyester, 78% PVC	137 cm	650 g/m <sup>2</sup>
F3o	1120.00	Plano	62303900	100% polyester	142 cm +/- 2 cm	265 g/m <sup>2</sup>
F4o	1240.00	Laser RE	63100600	100% recycled polyester	144 cm +/- 2 cm	520 g/m <sup>2</sup>
		Mello	62407700	80% cotton, 20% polyester	142 cm +/- 2 cm	530 g/m <sup>2</sup>
		Reflect	63100900	100% recycled polyester	142 cm +/- 2 cm	310 g/m <sup>2</sup>
F6o	1570.00	Hopsak	62300500	100% polyamide	127 cm +/- 2 cm	550 g/m <sup>2</sup>
		Olimpo	62401400	70% linen, 30% rayon	146 cm +/- 3 cm	520 g/m <sup>2</sup>
		Twill	62403300	30% polyamide, 70% new wool	155 cm +/- 2 cm	325 g/m <sup>2</sup>
		Volo	62404700	15% polyamide, 85% new wool	145 cm +/- 3 cm	435 g/m <sup>2</sup>
F8o	1910.00	Corsaro	62403900	5% polyamide, 10% cotton, 46% polyacrylics, 5% linen, 20% wool, 14% polyester	140 cm +/- 2 cm	450 g/m <sup>2</sup>
		Cosy 2	62407600	20% polyamide, 80% new wool	154 cm +/- 2 cm	590 g/m <sup>2</sup>
		Dumet	62403600	9% polyamide, 46% cotton, 8% linen, 22% wool, 15% rayon	147 cm +/- 2 cm	485 g/m <sup>2</sup>
		Iroko 2	62406300	32% cotton, 48% polyacrylics, 20% polyester	152 cm +/- 3 cm	700 g/m <sup>2</sup>
		Linho	62407000	9% polyamide, 91% linen	137 cm +/- 2 cm	450 g/m <sup>2</sup>
		Savana	63100400	8% polyamide, 19% cotton, 50% polyacrylics, 23% linen	140 cm	820 g/m <sup>2</sup>
		Tress	62407300	8% polyamide, 73% new wool, 19% polyester	142 cm +/- 2 cm	310 g/m <sup>2</sup>
F1oo	2280.00	Aura	62405900	3% polyamide, 97% new wool	144 cm +/- 2 cm	390 g/m <sup>2</sup>
		Nubia	63100300	2% polyamide, 30% new wool, 25% polyacrylics, 43% polyester	140 cm	570 g/m <sup>2</sup>
		Reed	62407200	7% polyamide, 48% cotton, 25% new wool, 20% linen	142 cm +/- 2 cm	400 g/m <sup>2</sup>
		Tonus	62309800	90% new wool, 10% helanca	140 cm	490 g/m <sup>2</sup>
F12o	2660.00	Credo	62401300	5% polyamide, 95% new wool	145 cm +/- 2 cm	640 g/m <sup>2</sup>
		Track	62408100	10% polyamide, 90% new wool	143 cm +/- 2 cm	480 g/m <sup>2</sup>
F2oo	3970.00	Checker	62406201	77% cotton, 23% polyester	140 cm	467 g/m <sup>2</sup>



# Overview of cover materials

## Leathers with a price group

Leather exclusively available in half (ca. 2.7 m<sup>2</sup>) or full hides (ca. 5-6 m<sup>2</sup>).

Price group	without VAT in SEK / m <sup>2</sup>		Article no.	Material	Thickness
L10	-	Leather Liso	*	Split leather	1.8-2.0 mm
L20	-	Leather Forte (deco)	*	Split leather with decorative finish	1.8-2.0 mm
		Leather	62300100	Robust cowhide with a distinctive, even grain	1.1-1.3 mm
L50	3480.00	Leather Premium F	63100500	Semi-aniline nappa leather with a very soft and supple feel, vegetable tanned	1.1-1.3 mm
L60	5060.00	Leather Natural F	62401700	Aniline nappa leather with a natural open-pore grain, vegetable tanned	1.1-1.3 mm

\* The material cannot be ordered from Vitra in linear metres/hides.

# Overview of cover materials

## Textiles with no price group

Fabric orders in full metres only.

without VAT in SEK / lin. m		Article no.	Material	Width	Weight
-	Coda	*	10% nylon, 90% new wool	140 cm	860 g/m <sup>2</sup>
110.00	Diamond Mesh	62401900	100% polyester	165 cm	600 g/m <sup>2</sup>
-	Drop	*	20% nylon, 60% new wool, 20% polyester	157 cm +/- 2 cm	520 g/m <sup>2</sup>
1930.00	FleeceNet	62404900	46% polyamide, 1% spandex, 53% polyester	135 cm +/- 2 cm	430 g/m <sup>2</sup>
-	Intreccio	*	23% cotton, 77% new wool	140 cm	780 g/m <sup>2</sup>
1570.00	Netweave Aluminium Chair	62301000	71% polyurethane, 29% polyester	138 cm +/- 2 cm	630 g/m <sup>2</sup>
-	Planum	*	14% nylon, 44% new wool, 42% polyester	162 cm +/- 2 cm	400 g/m <sup>2</sup>
110.00	Silk Mesh nero	62402000	33% polyamide, 67% polyester	170 cm +/- 3 cm	300 g/m <sup>2</sup>
	Silk Mesh colours		100% polyester		
-	Simmons	*	83% polypropylene, 17% polyester	140 cm	330 g/m <sup>2</sup>
-	Duo Knit	**	4% spandex, 96% polyester		540 g/m <sup>2</sup> +/- 10%
-	Netline	**	100% polyester		360 g/m <sup>2</sup>
-	SingleKnit	**	5% spandex, 95% polyester		475 g/m <sup>2</sup>
-	Striped Knit	**	4% spandex, 96% polyester		540 g/m <sup>2</sup> +/- 10%
-	Tricot Slow Chair	**	100% polyester		607 g/m <sup>2</sup>
-	TrioKnit	**	4% spandex, 96% polyester		607 g/m <sup>2</sup>

\* The material cannot be ordered from Vitra in linear metres/hides.

\*\* The covers are knit-to-fit and not available by the metre.



## Office task chair, using the example of ID Soft

Dimensions measured in accordance with EN 1335-1:2000

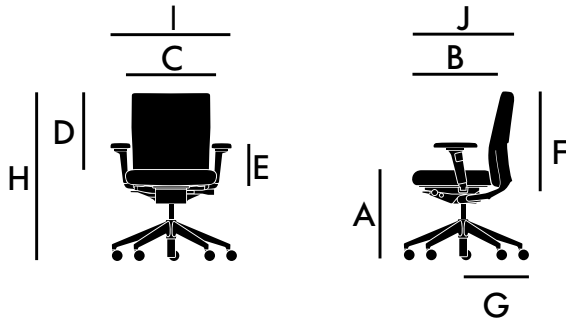
**A Seat height**

(measured at central vertical axis with applied weight load of 64 kg)

**B Seat depth**

(distance from front edge of seat to foremost point of the lumbar zone)

**C Seat width**

(measured horizontally to central vertical axis)

**D Height of top edge of backrest from seat surface**

(measured at central vertical axis with applied weight load of 64 kg)

**E Height of armrest from seat surface**

(measured at central vertical axis with applied weight load of 64 kg)

**F Height of backrest section****G Maximum base radius**

(including castors/glides)

**H Height****I Width of upper part****J Depth of upper part**

## Visitor chair, using the example of the Softshell Chair

Dimensions measured in accordance with EN 1335-1:2000

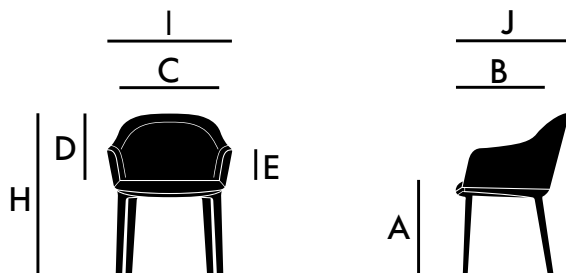
**A Seat height**

(measured in back third of seat surface with applied weight load of 64 kg)

**B Seat depth**

(distance from front edge of seat to foremost point of the lumbar zone)

**C Seat width**

(measured in back third of seat surface with applied weight load of 64 kg)

**D Height of top edge of backrest from seat surface**

(measured at central vertical axis with applied weight load of 64 kg)

**E Height of armrest from seat surface**

(measured from back third of seat surface with applied weight load of 64 kg)

**H Height****I Width****J Depth**

## Lounge chairs and armchairs, using the example of the Eames Lounge Chair

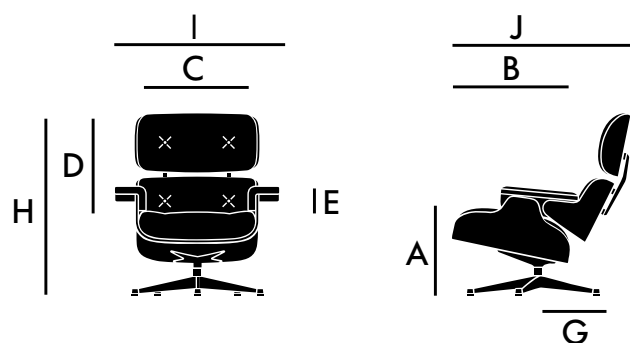
**A Seat height**

(highest point of the seat in new condition, without applied load, measured along axis of symmetry)

**B Seat depth**

(distance from front edge of seat to foremost point of the lumbar zone)

**C Seat width**

(horizontal to central vertical axis with applied weight load of 64 kg)

**D Height of top edge of backrest from seat surface**

(measured at central vertical axis with applied weight load of 64 kg)

**E Height of armrest from seat surface**

(measured at central vertical axis with applied weight load of 64 kg)

**G Maximum base radius**

(including castors/glides)

**H Height****I Width of upper part****J Depth of upper part**

With upholstered furniture, dimensions can vary by up to approximately 30 mm due to varying firmness and a tolerance range for the convex profiles of foam padding.

If the seat height measured in accordance with EN 1335-1:2000 is listed, it has been measured in the rear third of the seat surface under a weight load of 64 kg.

## Sofas, using the example of the Suita Sofa

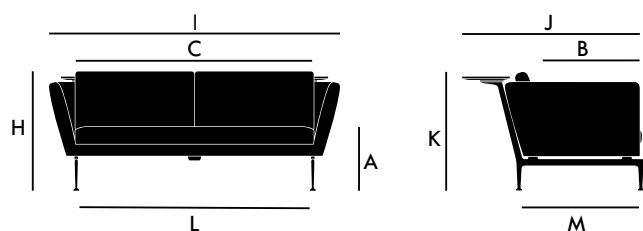
**A Seat height**

(highest point of the seat in new condition, without applied load)

**B Seat depth**

(distance from front edge of seat to foremost point of the lumbar zone)

**C Seat width****H Height****I Width of body****J Depth of body****K Height of shelf****L Width of base**

(distance from inner edge to inner edge)

**M Depth of base**

(distance from inner edge to inner edge)

With upholstered furniture, dimensions can vary by up to approximately 30 mm due to varying firmness and a tolerance range for the convex profiles of foam padding.

If the seat height measured in accordance with EN 1335-1:2000 is listed, it has been measured in the rear third of the seat surface under a weight load of 64 kg.













**vitra.**

Color & Material Library  
2023

english



# Colour & Material Library

**vitra.**

The Vitra Colour & Material Library comprises a variety of textiles and leathers, but also features solid materials, including the colours and textures of plastics, metals, woods and other materials. Together, these form a system offering countless possible combinations with a coherence that make it easy for architects, interior designers or private clients to define a lively interior collage with a strong identity.

*'The Vitra Colour & Material Library encourages creative freedom and fires the imagination – not by making everything possible, but by providing a clear display of options.'*  
Hella Jongerius.



## Hella Jongerius

The Dutch designer Hella Jongerius lives and works in Berlin. She founded the Jongeriuslab studio in 1993. For Vitra, the Dutch designer has developed distinctive pieces such as the Polder Sofa and the East River Chair. Jongerius has consistently addressed the significance of colours and surfaces in contemporary design in her work with textiles, ceramics and furniture. She has been the Art Director for colours and materials at Vitra for

many years and developed the Vitra Colour & Material Library – a system that enables the versatile combination of different materials and colours throughout the extensive Vitra product collection.



© Studio Likeness

## Colour Worlds

The aim of this collaboration is to create a unique realm of Vitra colours and materials that augment contemporary designs and renew classic pieces in the collection. Her colour concept for Vitra organises all colours in four contrasting colour worlds. The greens, the reds, the lights and the darks suit both home and office. The system encompasses the entire spectrum of colours,

while the different colour worlds classify their specific purpose. The Vitra Colour and Material Library is no advice kit. It is to be used as a tool, both within the design and production process as well as outside of the company grounds.

### GREENS

After living in a green environment for thousands of years, distinguishing prey or edible plants, our eyes' colour receptors have become most sensitive to the greens. A biological evolutionary process now enables us to differentiate many shades.



### DARKS

Retreating and absorbing, the darks are more distant and calm. They take in light and hold warmth. They are shadow colours – the darker a colour, the further it seems to be away from its observer.



### LIGHTS

The light colours, which we call 'lights', accentuate, reflect and project other colours. They remind us of an empty sheet of paper, untouched snow and are a Western symbol of purity.



### REDS

Red hues appear vibrant, dynamic and more immediate than other colours. Along with oranges and yellows, they need light to unfold their true beauty. Red is the first colour that babies acknowledge.





## Bridge Colour Palettes

Bridge colours in the Vitra Colour and Material Library offer a link between various contrasting objects and materials. Every bridge colour appears in several materials and textiles and results in a corresponding palette – a range of hues based on one single tone that vary slightly in appearance, depending on the material's characteristics. Every new colour is designed to accentuate the respective material's texture and surface qualities. Because whether a surface is glossy, translucent or rough, and how the surfaces react to shadow play and reflections, determines the colour's hue within a bridge colour palette.

The brick colour looks darker on a matt plastic than in an Aura fabric because the textile's construction is based on a cluster of yarns and binding that exhibit a satiny complexion. The customer can choose from a range of colour options and materials within each bridge colour palette to create a link between various pieces of furniture for tone-on-tone settings.

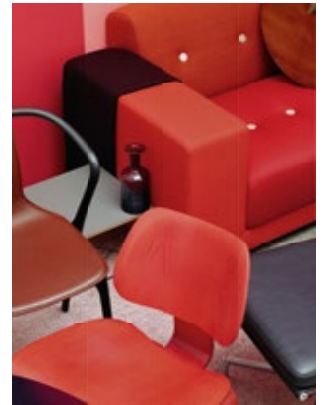
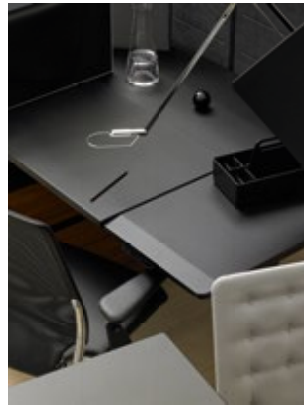
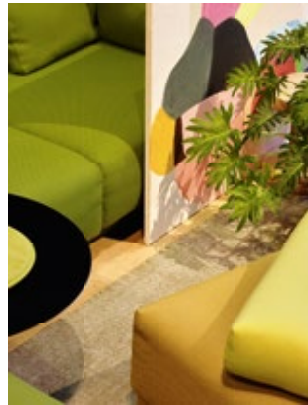

cognac



avocado



mustard



basic dark



brick



poppy red



blue



coffee



warm grey



ice grey



classic red



chocolate



cream



light grey

## Duotones

A duotone weave, just like an impressionist painting, can demonstrate how the perception of colours is an activity. Participation is necessary in order to actually see the colour emerge from the thick and loose yarns or brushstrokes. The world of industrial production tends to exclude such activity, as it excludes instability. Yet it is precisely this instability that brings colours to life and makes us gaze at them.

The duotone concept sets up a colour conversation between the warp and the weft. The warp is typically in a darker colour than the weft yarn, which gives an optical depth to the weave. The interweaving of two different colours unites the realm of office spaces with the softness and intimacy of home. A colour composed of layers keeps a colour fascinating. You have to blink twice. Is that surface red? Or is it grey? It does not look the same in the morning as it does in the evening or in winter and summer.

### Hopsak

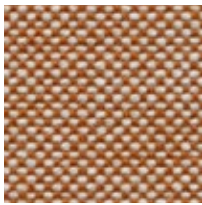

88  
cognac/ivory



63  
red/poppy red

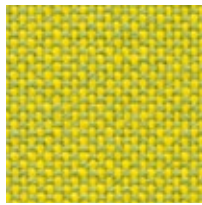

71  
yellow/pastel green

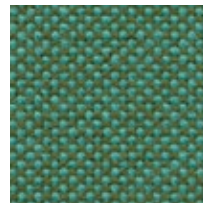

86  
mint/forest

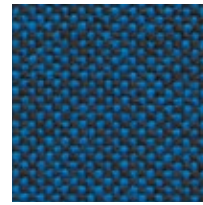

84  
blue/moor brown

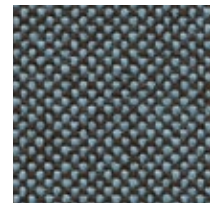

82  
ice blue/moor brown



## Designer Libraries

Within the Vitra Colour & Material Library each designer developed it's own colour palette based on his own aesthetics, the design approach and the furniture shape. The library guarantees that almost all colours, surfaces and textiles are easy to combine or offers matching colour partners – even across the different Designers libraries. In addition the so called signature colours make the individual palettes unique for each designer. Signature colours are shades that can only be used by one designer. They are sometimes even limited to one product only. Usually, design-

ers themselves will suggest a signature colour because they like that specific shade or have a particular role in mind for this colour. When re-introducing classic designs, a decision will be made in close cooperation with Hella Jongerius and the respective designer's family or heirs.



Konstantin Grcic   Antonio Citterio   Jay Osgerby   Alberto Meda   Jasper Morrison   Erwan Bouroullec & Ronan Bouroullec   Edward Barber   Hella Jongerius



Erwan & Ronan Bouroullec



Hella Jongerius



Jasper Morrison

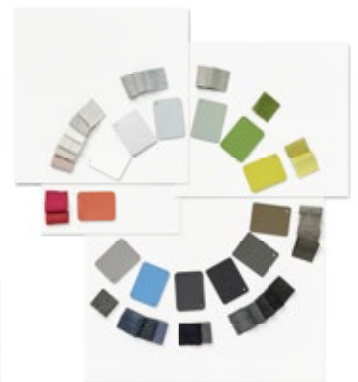

Jay Osgerby & Edward Barber

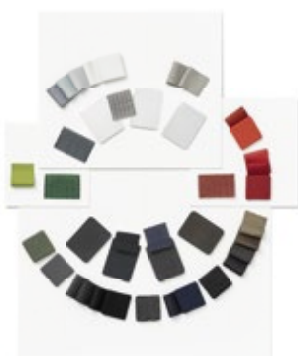

Alberto Meda



Charles Eames



Jean Prouvé



Konstantin Grcic

**Textiles**

8	Aura	21	LightNet	34	Silk Mesh
9	Checker	22	Linho	35	Simmons
10	Corsaro	23	Mello	36	SingleKnit
11	Cosy 2	24	Netline	37	Striped Knit
12	Credo	25	Netweave Aluminium Chair	38	Tonus
13	Diamond Mesh	26	Nova	39	Track
14	Drop	27	Nubia	40	Tress
15	Dumet	28	Olimpo	41	TrioKnit
16	Duo Knit	29	Plano	42	Twill
17	FleeceNet	30	Planum	43	Volo
18	Hopsak	31	Reed	44	Overview of cover materials
19	Iroko 2	32	Reflect		
20	Laser RE	33	Savana	46	Kvadrat Selection

**Leather**

50	Leather
53	Leather Premium F
56	Leather Natural F
57	Leather Forte (deco)
58	Leather Liso
59	Overview of Leather

**Surfaces**

60	Plastic	79	HPL
64	Recycled plastic	80	Solid core HPL
65	Fibreglass	81	Linoleum
66	Polyurethane	81	Bonded leather
67	Metal	82	Marble
73	Solid Wood	82	Glass
75	Veneer	83	Cork
77	MDF	83	Corrugated Cardboard
78	Melamine	84	Fleece

**Product-specific combinations**

85	East River Chair
86	Polder
87	Slow Chair & Ottoman

# Aura

## Home, F100

**vitra.**



The woollen textile Aura has a classic satin (atlas) weave with a fine, soft surface. This fabric is distinguished by a supremely soft feel, lustrous sheen and smooth even surface. The solid and mixed colours feature dynamic, highly saturated tones made possible by wool's excellent dyeability.

Aura is available in 26 colours.

Material	3% polyamide, 97% new wool
Weight	390 g/m <sup>2</sup> (11.5 oz/y <sup>2</sup> )
Width	144 cm +/- 2 cm (56")
Abrasion resistance	20,000 Martindale
Fastness to light	Type 5
Pilling	Grade 3-4
Fastness to rubbing	Grade 3-4 dry and wet

Citizen (neck cushion)  
Mariposa Club Armchair  
Mariposa Sofa  
Soft Modular Sofa  
Softshell Chair

### Aura

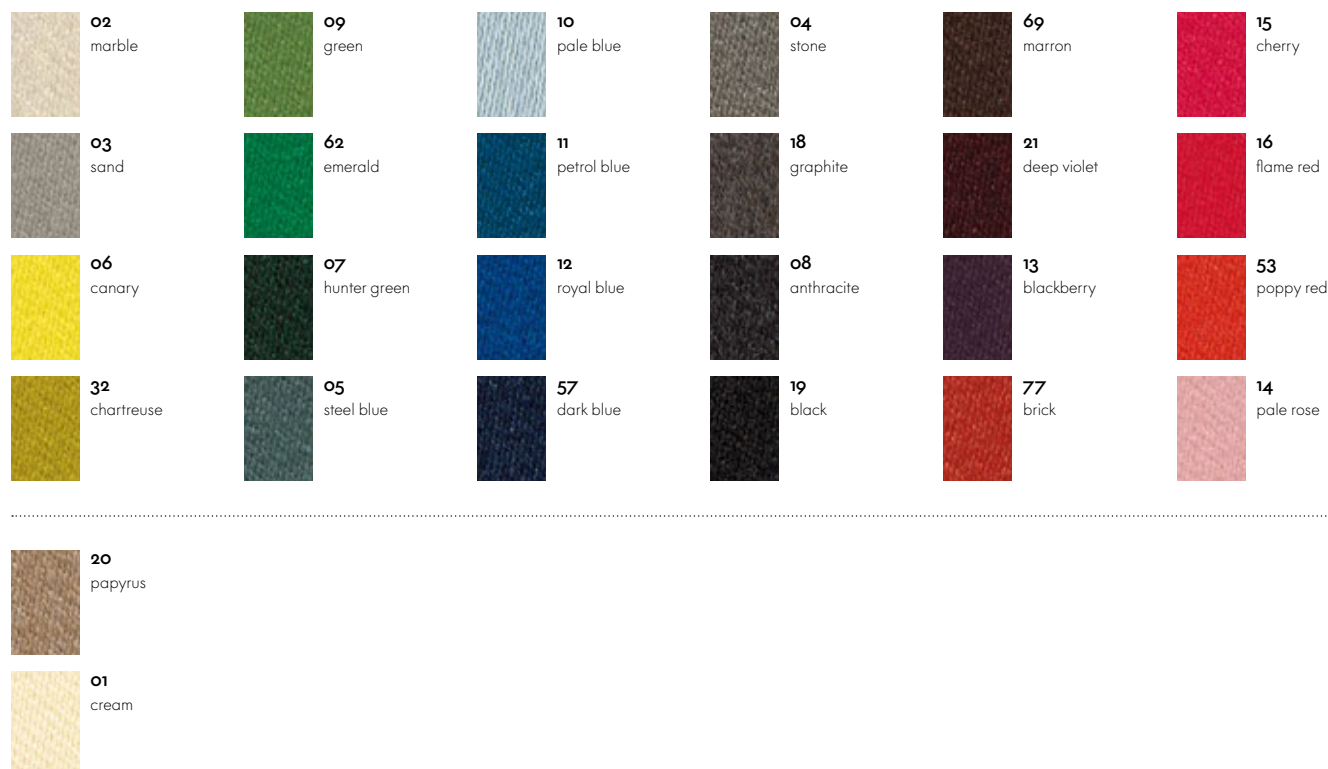

# Checker

Home, F200

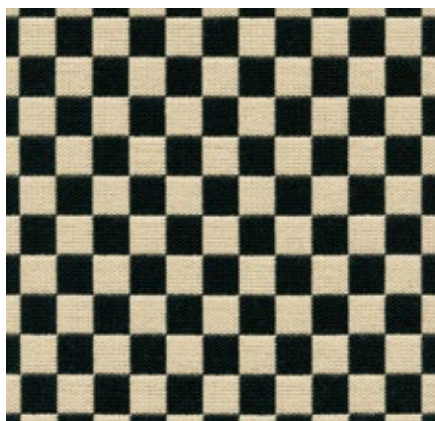

Alexander Girard developed the textile pattern 'Checker' in 1965 as part of his legendary redesign of the corporate image for Braniff International Airlines. The checkerboard design is a prime illustration of Girard's radical break from the conventional low-key aesthetic that characterised the sector at that time. The soft double weave fabric, with a high percentage of cotton, demonstrates exceptional purity of colour and its geometric pattern lends a striking note to any environment.

Material	77% cotton, 23% polyester
Weight	467 g/m <sup>2</sup> (13.8 oz/y <sup>2</sup> )
Abrasion resistance	20,000 Martindale
Fastness to light	Type 6
Pilling	Grade 4-5
Fastness to rubbing	Grade 4-5 dry and wet

Eames Plastic Chairs  
Wire Chair

## Checker



01  
black/white

# Corsaro

Home, F80

**vitra.**



Corsaro is a sophisticated combination of fine and coarse yarns that give the fabric a natural look with a Mediterranean flair.

The two-tone and three-tone shades interwoven with several novelty yarns add particular vibrancy to large surface areas.

Corsaro is available in 13 colours.

Material	5% polyamide, 10% cotton, 46% polyacrylics, 5% linen, 20% wool, 14% polyester
Weight	450 g/m <sup>2</sup> (13.3 oz/y <sup>2</sup> )
Width	140 cm +/- 2 cm (55'')
Abrasion resistance	35,000 Martindale
Fastness to light	Type 5
Pilling	Grade 3-4
Fastness to rubbing	Grade 3-4 dry and wet

Grand Relax  
Grand Sofà  
Mariposa Club Armchair  
Mariposa Sofa

Soft Seats  
Suita Club Armchair  
Suita

## Corsaro



**01**  
pale blue  
melange



**11**  
steel blue  
melange

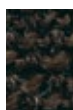

**02**  
dark brown  
melange



**08**  
sierra  
melange



**04**  
dark blue  
melange



**07**  
canola  
melange



**10**  
pepper  
melange



**03**  
dark grey  
melange



**09**  
bamboo  
melange



**12**  
graphite  
melange



**13**  
black  
melange



**05**  
stone  
melange



**06**  
sand  
melange

# Cosy 2

Home/Office, F80

**vitra.**



Cosy 2 is a high-quality milled woollen cloth with a warm character. The lively melange yarn emphasises the fabric's natural colours – from delicate shades to vibrant hues – and gains added elegance with colour-coordinated stitching. The fabric offers thermal comfort and excellent durability, making it suited for upholstered furniture in office settings as well as residential applications.

Cosy 2 is available in 15 colours.

Material	20% polyamide, 80% new wool
Weight	590 g/m <sup>2</sup> (17.4 oz/y <sup>2</sup> )
Width	154 cm +/- 2 cm (60")
Abrasion resistance	50,000 Martindale
Fastness to light	Type 6
Pilling	Grade 4-5
Fastness to rubbing	Grade 4-5 dry and wet

Alcove  
Alcove Plus  
Citizen

Grand Relax  
Grand Sofà  
HAL Lounge Chair

Organic Chair  
Soft Modular Sofa  
Soft Seats

## Cosy 2

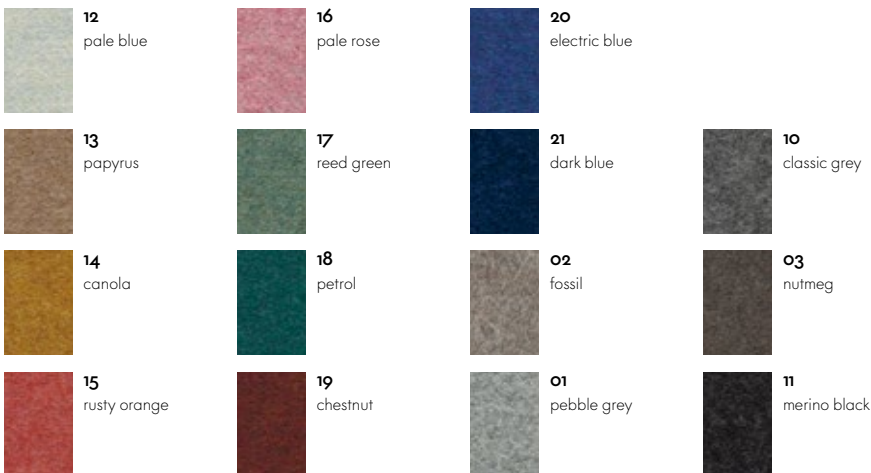

Petit Repos  
Repos & Grand Repos

Suita Club Armchair  
Suita

## Cosy 2 (cross stitch)





# Credo

Home/Office, F120

**vitra.**



Credo is a durable woollen fabric made of premium worsted yarn with a pleasant feel. The two- and three-tone colours give this fabric a characteristic structure and vibrant appearance. Credo allows for an effective exchange of heat to ensure comfortable thermal conditions for the sitter. The fabric can also be used in office environments.

Credo is available in 22 colours.

Material	5% polyamide, 95% new wool
Weight	640 g/m <sup>2</sup> (18.9 oz/y <sup>2</sup> )
Width	145 cm +/- 2 cm (57")
Abrasion resistance	100,000 Martindale
Fastness to light	Type 6
Pilling	Grade 4-5
Fastness to rubbing	Grade 4-5 dry and wet

Alcove  
Alcove Plus  
Citizen  
Freeform Sofa  
Grand Sofà  
HAL Lounge Chair

HAL Soft  
Mariposa Club Armchair  
Mariposa Sofa  
Organic Chair  
Petit Repos  
Repos & Grand Repos

Soft Modular Sofa  
Soft Seats  
Suita  
Suita Club Armchair  
Suita Club Sofa

## Credo



**11**  
cream/dolphin



**20**  
dolphin/steel blue



**06**  
anthracite/elephant



**05**  
chocolate/black



**16**  
red chilli



**14**  
sand/avocado



**21**  
royal blue/elephant



**07**  
black/anthracite



**27**  
bitter chocolate



**15**  
saffron



**19**  
lime/curry



**22**  
emerald/ivy



**08**  
dark blue/black



**24**  
mauve grey/mid-grey



**23**  
pale rose/dark orange



**12**  
rock



**13**  
salt'n pepper



**26**  
teal blue/black

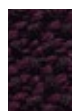

**17**  
black/aubergine



**25**  
mother-of-pearl/black



**18**  
pale rose/cognac



**01**  
cream

# Diamond Mesh

Home/Office

**vitra.**

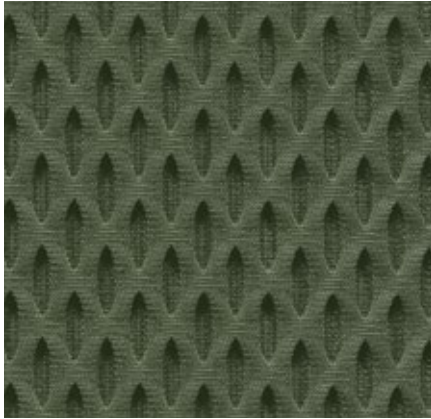

Diamond Mesh is a technical spacer fabric with a three-dimensional honeycomb structure. The hollow cells in the hexagonal structure facilitate air circulation and ensure comfortable thermal conditions. These characteristics, combined with the technical, yet vibrant look of this robust knit, make it an excellent choice for office settings.

Diamond Mesh is available in 7 colours.

Material	100% polyester
Weight	600 g/m <sup>2</sup> (17.7 oz/y <sup>2</sup> )
Width	165 cm (64")
Abrasion resistance	45,000 Martindale
Fastness to light	Type 6
Pilling	Grade 4-5
Fastness to rubbing	Grade 4-5 dry and wet

ID Mesh

ID Visitor Mesh

Unix Chair

## Diamond Mesh



**24**  
soft grey



**21**  
dim grey

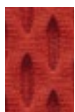

**77**  
brick



**67**  
asphalt



**01**  
olive green



**66**  
nero



**02**  
smoke blue

# Drop

## Home/Office



Drop is a knitted upholstery fabric with a lively three-dimensional look. Designed with colour compositions of up to three different hues, Drop exhibits a pattern reminiscent of a string of coloured pearls in a interplay of light and shadow. The robust knit fabric is suited for home settings, as well as public spaces.

Drop is available in 10 colours.

Material	20% nylon, 60% new wool, 20% polyester
Weight	520 g/m <sup>2</sup> (15.3 oz/y <sup>2</sup> )
Width	157 cm +/- 2 cm (61")
Abrasion resistance	80,000 Martindale
Fastness to light	Type 6
Pilling	Grade 4-5
Fastness to rubbing	Grade 4-5 dry and wet

## Abalon

### Drop



**09**  
beige/cream  
(101)



**02**  
dark green/  
ochre (951)



**06**  
light grey/cream  
(121)



**01**  
dark green/  
green (961)



**08**  
mauve/beige  
(221)



**03**  
dark green/grey  
(971)



**04**  
dark red/red  
(691)



**07**  
dark grey/  
mauve (261)



**05**  
dark red/mauve  
(671)



**10**  
black/dark grey  
(191)

# Dumet

## Home, F8o



Dumet is a cotton blend in a plain weave with a lively appearance. The natural mixed tones create an elegant look with an Italian flair. Dumet is soft and cool to the touch.

Dumet is available in 20 colours.

Material	9% polyamide, 46% cotton, 8% linen, 22% wool, 15% rayon
Weight	485 g/m <sup>2</sup> (14.3 oz/y <sup>2</sup> )
Width	147 cm +/- 2 cm (57'')
Abrasion resistance	40,000 Martindale
Fastness to light	Type 5
Pilling	Grade 3-4
Fastness to rubbing	Grade 3-4 dry and wet

Grand Relax  
Grand Sofà  
HAL Lounge Chair  
HAL Soft  
Mariposa Club Armchair

Mariposa Sofa  
Petit Repos  
Repos & Grand Repos  
Soft Modular Sofa  
Soft Seats

Softshell Chair  
Suita Club Armchair  
Suita

### Dumet

 <b>30</b> blackberry melange	 <b>06</b> pebble melange	 <b>11</b> yellow melange	 <b>10</b> pale rose/beige	 <b>07</b> ginger/grey
 <b>31</b> Dumet - indigo melange	 <b>27</b> pale blue/emerald	 <b>24</b> mango melange	 <b>23</b> pale rose/coral	 <b>03</b> beige/grey
 <b>33</b> carbon/black	 <b>28</b> Dumet - sage/steel blue	 <b>25</b> ochre melange	 <b>29</b> dark red melange	 <b>02</b> beige melange
 <b>32</b> sierra grey melange	 <b>26</b> pale blue/chartreuse	 <b>22</b> pale blue/pale rose	 <b>17</b> sand melange	 <b>01</b> ivory melange

# Duo Knit

## Home/Office



Duo Knit is an elastic form-fitted knit fabric designed especially for the ID Cloud backrest. The lightly textured surface gives it an inviting high-quality appearance.

Duo Knit is available in 7 colours.

Material	4% spandex, 96% polyester
Weight	540 g/m <sup>2</sup> +/- 10%
Abrasion resistance	40,000 Martindale
Fastness to light	Type 6
Pilling	Grade 4-5
Fastness to rubbing	Grade 4-5 dry and wet

---

## ID Cloud

---

### Duo Knit

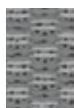

**01**  
cream white/  
sierra grey



**05**  
ink blue/  
turquoise



**03**  
petrol/  
nero



**06**  
brick/  
orange



**02**  
dark grey/  
nero



**04**  
dark red/  
nero



**07**  
nero

---

# FleeceNet

Home/Office

**vitra.**

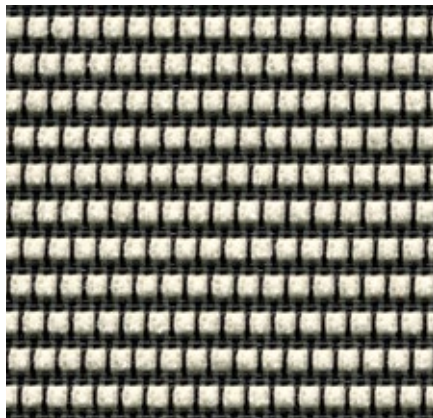

FleeceNet is a technical netweave made of polyester and polyamide with an interwoven chenille yarn. FleeceNet does not have a closed surface, making it breathable and promoting comfortable thermal conditions. The interweaving of different yarns allows for a variety of new colour combinations.

FleeceNet is available in 4 colours.

Material	46% polyamide, 1% spandex, 53% polyester
Weight	430 g/m <sup>2</sup> (12.7 oz/y <sup>2</sup> )
Width	135 cm +/- 2 cm (53")
Abrasion resistance	100,000 Martindale
Fastness to light	Type 6
Pilling	Grade 4-5
Fastness to rubbing	Grade 4-5 dry and wet

Physix

## FleeceNet



**07**  
soft grey



**03**  
ice grey



**08**  
mid-grey



**01**  
black

# Hopsak

Home/Office, F60

**vitra.**

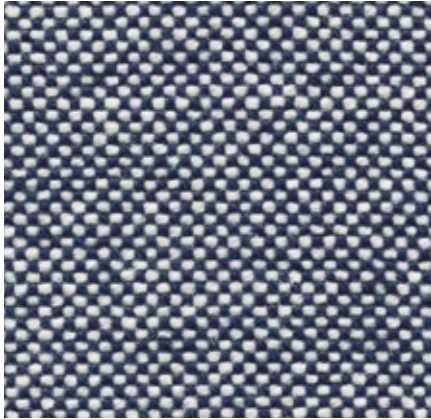

Hopsak is an expressive, flat plain-weave fabric made of polyamide. The duotone colours offer a multitude of design possibilities in high-contrast, brightly hued or subtle combinations of warp and weft threads. Highly durable and robust, Hopsak can be used in private interiors as well as public areas.

Hopsak is available in 35 colours.

Material	100% polyamide
Weight	550 g/m <sup>2</sup> (16.2 oz/y <sup>2</sup> )
Width	127 cm +/- 2 cm (50")
Abrasion resistance	200,000 Martindale
Fastness to light	Type 6
Pilling	Grade 4-5
Fastness to rubbing	Grade 4-5 dry and wet

AC 5 Group  
Allstar  
Coconut Chair  
Eames Aluminium Group  
Eames Plastic Chairs

HAL  
HAL Armchair  
Organic Chair  
Soft Seats  
Visiona Stool

Wire Chair

## Hopsak

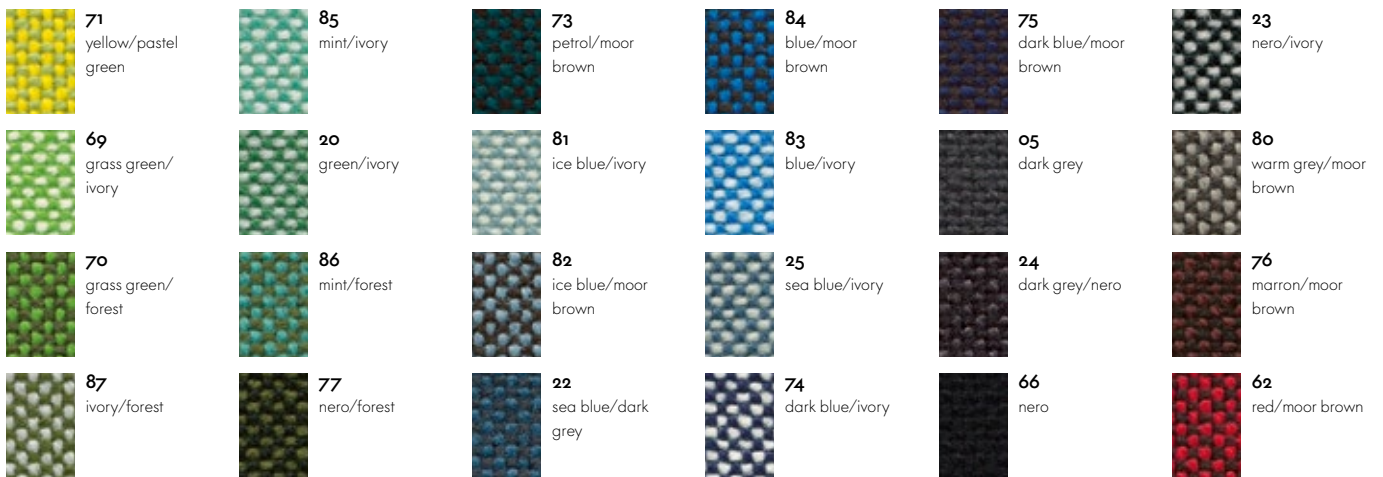

# Iroko 2

## Home, F80



Iroko 2 is a soft, flat woven fabric made with chenille yarn. The piles in the yarn give the weave a lively surface texture with an inviting, velvety touch. The fabric's cotton fibres provide excellent cooling properties.

Iroko 2 is available in 17 colours.

Material	32% cotton, 48% polyacrylics, 20% polyester
Weight	700 g/m <sup>2</sup> (20.6 oz/y <sup>2</sup> )
Width	152 cm +/- 3 cm (60")
Abrasion resistance	40,000 Martindale
Fastness to light	Type 5
Pilling	Grade 3-4
Fastness to rubbing	Grade 3-4 dry and wet

Grand Sofà  
Mariposa Club Armchair  
Mariposa Sofa  
Soft Modular Sofa  
Soft Seats

Suita Club Armchair  
Suita

### Iroko 2

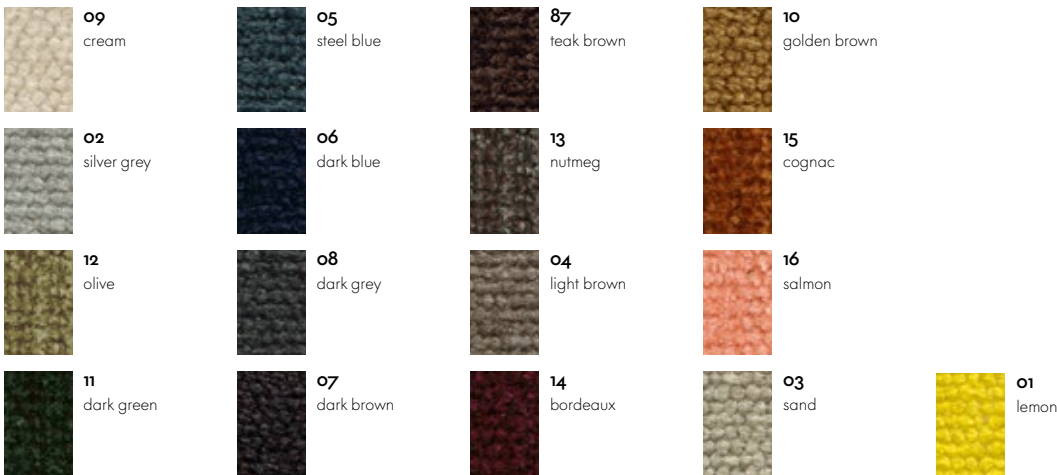



# Laser RE

## Home/Office, F40

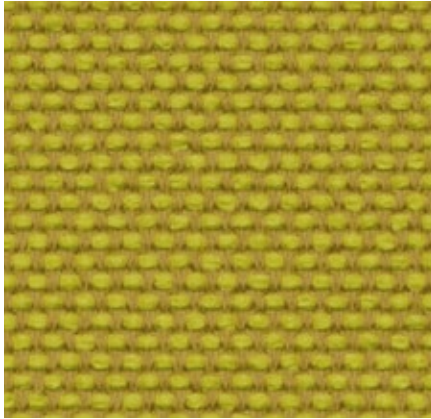

The environmentally friendly fabric Laser RE is made from recycled polyester. It has a distinctive woven appearance, which is particularly accentuated by contrasting duotones in a varied palette of 25 colours. Practical and easy to care for, as well as durable and highly abrasion-resistant, Laser RE is also well suited for office environments.

Laser RE is available in 25 colours.

Material	100% recycled polyester
Weight	520 g/m <sup>2</sup>
Width	144 cm +/- 2 cm
Abrasion resistance	100,000 Martindale
Fastness to light	Type 6
Pilling	Grade 4-5
Fastness to rubbing	Grade 4-5 dry and wet

Alcove  
Alcove Plus  
Citizen  
HAL Lounge Chair  
ID Chair Concept

ID Visitor  
Mariposa Club Armchair  
Mariposa Sofa  
Soft Modular Sofa  
Soft Seats

Softshell Chair  
Suita Club Armchair  
Suita Club Sofa  
Suita  
Visiona Stool

### Laser RE

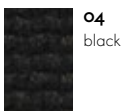

# LightNet

Home/Office

**vitra.**

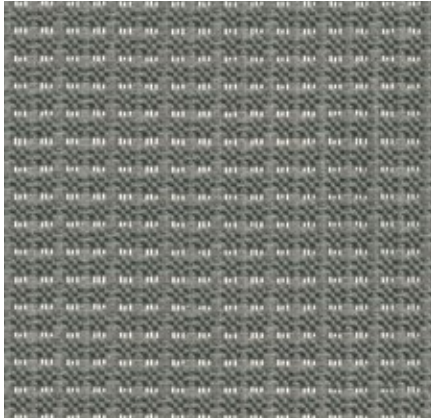

LightNet is a subtly textured, breathable mesh fabric with a soft feel. Due to the type of weave, LightNet has a square pattern with a transparent effect in the vertical direction. This robust mesh fabric made of polyester and polyamide comes in tone-in-tone colours and is ideally suited to the demanding conditions of office environments.

LightNet is available in 3 colours.

Material	60% polyamide, 40% polyester
Weight	380 g/m <sup>2</sup> (11.2 oz/y <sup>2</sup> )
Width	125 cm +/- 3 cm (49")
Abrasion resistance	100,000 Martindale
Fastness to light	Type 6
Pilling	Grade 4-5
Fastness to rubbing	Grade 4-5 dry and wet

---

AM Chair Netweave backrest

---

## LightNet



**01**  
black



**02**  
sierra grey



**03**  
white

# Linho

## Home, F80

**vitra.**



The high-quality linen fabric Linho is manufactured in Belgium, from the plant to the finished textile. It has the slightly irregular appearance that is typical of linen yarn. Due to its high percentage of linen, Linho tends to form elegant creases, lending a natural look to soft upholstered furniture.

Linho is available in 10 colours.

Material	9% polyamide, 91% linen
Weight	450 g/m <sup>2</sup> (13.3 oz/y <sup>2</sup> )
Width	137 cm +/- 2 cm (54")
Abrasion resistance	18,000 Martindale
Fastness to light	Type 5
Pilling	Grade 3
Fastness to rubbing	Grade 3 dry and wet

Grand Sofà  
Mariposa Club Armchair  
Mariposa Sofa  
Soft Modular Sofa  
Softshell Chair

Suita Club Armchair  
Suita

### Linho



**07**  
olive

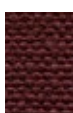

**06**  
chestnut

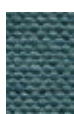

**08**  
steel blue

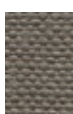

**03**  
truffle



**09**  
atlantic



**04**  
canola



**02**  
sand

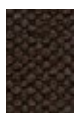

**10**  
moor brown

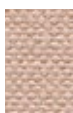

**05**  
rose quartz



**01**  
pearl

# Mello

## Home, F40

**vitra.**

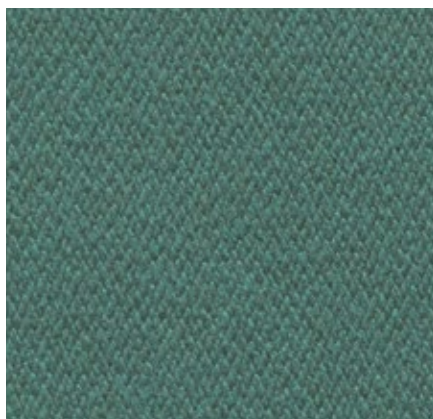

Mello is an elegant cotton fabric with a pleasant softness and cool tactile qualities. Thanks to a thicker melange yarn of recycled cotton, the robust twill weave has a lively yet balanced appearance. The understated colour palette for Mello ranges from pastel tones to natural, earthy shades and darker hues.

Mello is available in 9 colours.

Material	80% cotton, 20% polyester
Weight	530 g/m <sup>2</sup> (15.6 oz/y <sup>2</sup> )
Width	142 cm +/- 2 cm (56")
Abrasion resistance	30,000 Martindale
Fastness to light	Type 5
Pilling	Grade 4
Fastness to rubbing	Grade 3-4 dry and wet

Cité  
Grand Sofà  
Mariposa Club Armchair  
Mariposa Sofa

Soft Modular Sofa  
Suita Club Armchair  
Suita

### Mello

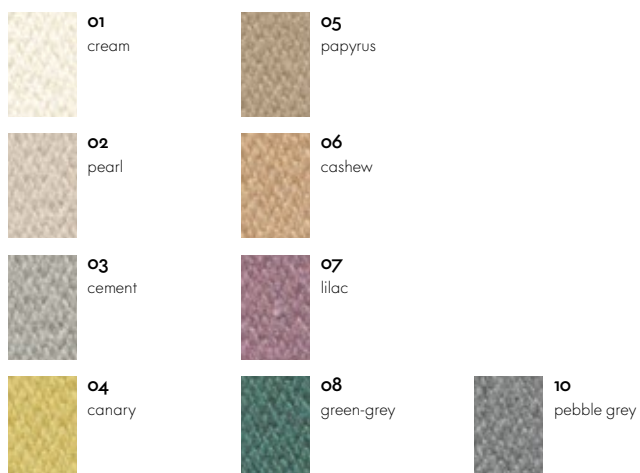

# Netline

Home/Office

**vitra.**



Netline is a technical knit that makes an ideal cover material for the backrests of chairs, thanks to its elasticity. The semi-transparent mesh look of Netline emphasises its technical properties.

Netline is available in 2 colours.

Material	100% polyester
Weight	360 g/m <sup>2</sup> (10.6 oz/y <sup>2</sup> )
Abrasion resistance	40,000 Martindale
Fastness to light	Type 6
Pilling	Grade 4-5
Fastness to rubbing	Grade 4-5 dry and wet

---

MedaSlim

---

## Netline (backrest only)

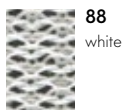

**88**  
white

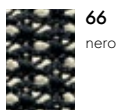

**66**  
nero

---

# Netweave

Home/Office

**vitra.**

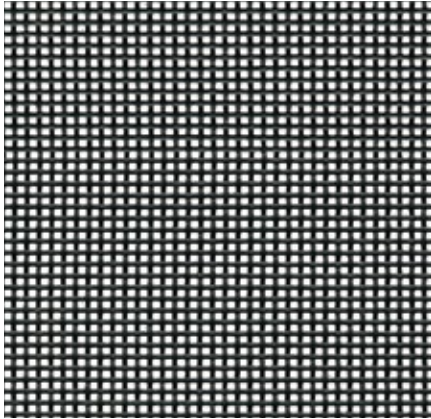

The semi-transparent, self-supporting netweave fabric combines a robust structure with an elegant, airy appearance. It is available in 2 colours.

Material	71% polyurethane, 29% polyester
Weight	630 g/m <sup>2</sup> (18.6 oz/y <sup>2</sup> )
Width	138 cm (54")
Fastness to light	Type 6
Fastness to rubbing	Grade 4-5 dry and wet

---

Aluminium Group

---

## Netweave



**66**  
nero



**05**  
dark grey

---

# Nova

Home/Office, F20

**vitra.**

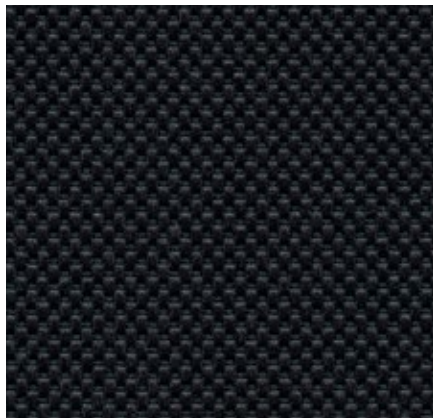

Nova is a classic fabric for use in office environments. Distinguished by a fine texture, this extremely robust and hard-wearing fabric has a soft surface sheen. The economical fabric serves as an ideal cover material for panels.

Nova is available in 1 colour.

Material	100% polyester
Weight	400 g/m <sup>2</sup> (11.8 oz/y <sup>2</sup> )
Width	142 cm +/- 2 cm (56")
Abrasion resistance	60,000 Martindale
Fastness to light	Type 6
Pilling	Grade 4-5
Fastness to rubbing	Grade 4-5 dry and wet

---

MedaSlim

---

Nova

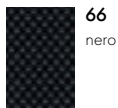

# Nubia

## Home, F100

**vitra.**



Nubia is a blended fabric with a very lively, natural appearance. Its fine substructure is interspersed with voluminous bouclé yarn, which gives the fabric depth and a soft, inviting touch. The varying combinations of yarns in natural tones yield either contrasting or calm colour compositions with a distinctly Mediterranean flair.

Nubia is available in 6 colours.

Material	2% polyamide, 30% new wool, 25% polyacrylics, 43% polyester
Weight	570 g/m <sup>2</sup> (16.8 oz/y <sup>2</sup> )
Width	140 cm (55")
Abrasion resistance	35,000 Martindale
Fastness to light	Type 5
Pilling	Grade 4
Fastness to rubbing	Grade 3-4 dry and wet

Fauteuil de Salon  
Fauteuil Direction  
Grand Relax  
Grand Sofà  
HAL Lounge Chair

Mariposa Club Armchair  
Mariposa Sofa  
Petit Repos  
Repos & Grand Repos  
Soft Modular Sofa

Suita  
Suita Club Armchair

### Nubia



**01**  
ivory/pearl



**02**  
cream/pearl



**03**  
cream/sand



**06**  
cream/sierra  
grey



**04**  
bamboo/terra

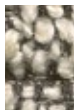

**05**  
cream/dark  
brown



# Olimpo

## Home, F60

**vitra.**

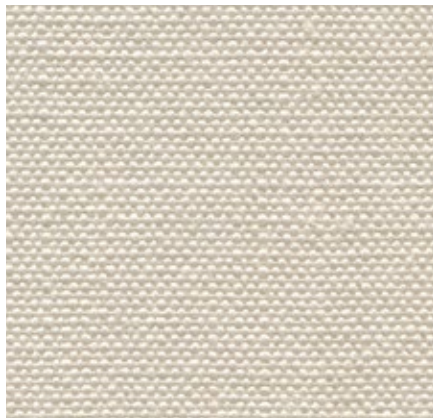

The typical linen texture of Olimpo gives the fabric a very fine and natural overall appearance. The fabric's high percentage of linen, clearly evident to the touch, results in comfortably cool conditions for the sitter. Thanks to the combination of viscose and linen, the fabric is durable and abrasion-resistant and exhibits a fine sheen.

Olimpo is available in 10 colours.

Material	70% linen, 30% rayon
Weight	520 g/m <sup>2</sup> (15.3 oz/y <sup>2</sup> )
Width	146 cm +/- 3 cm (57")
Abrasion resistance	30,000 Martindale
Fastness to light	Type 5
Pilling	Grade 3-4
Fastness to rubbing	Grade 3-4 dry and wet

Mariposa Club Armchair

Mariposa Sofa

Soft Modular Sofa

Suita Club Armchair

Suita

### Olimpo



**10**  
sierra grey

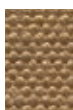

**08**  
kalahari



**06**  
graphite grey

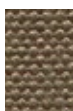

**05**  
taupe grey



**11**  
atlantic

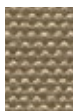

**04**  
sandstone

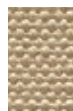

**07**  
parchment

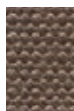

**09**  
mokka

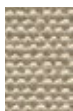

**03**  
bamboo



**02**  
pearl

# Plano

Home/Office, F30

**vitra.**

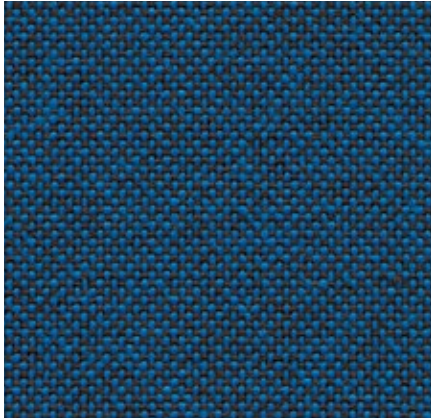

Plano is a robust plain weave with a flat, even texture. The wide palette of duotones with new, delicate washed-out shades includes many relatively neutral hues, a good number of which are coordinated with the Hopsak colour range. Thanks to its durability and longevity, Plano is also an ideal choice for office furnishings.

Plano is available in 39 colours.

Material	100% polyester
Weight	265 g/m <sup>2</sup> (7.8 oz/y <sup>2</sup> )
Width	142 cm +/- 2 cm (56")
Abrasion resistance	80,000 Martindale
Fastness to light	Type 6
Pilling	Grade 4-5
Fastness to rubbing	Grade 4-5 dry and wet

AC 5 Group  
AM Chair fabric backrest  
Citizen  
HAL Soft  
ID Chair Concept  
ID Visitor

Mariposa Club Armchair  
MedaSlim  
Rookie  
Soft Seats  
Softshell Chair  
Unix Chair

HAL **Seat cover, Plano (for orders of 6 or more)**

## Plano

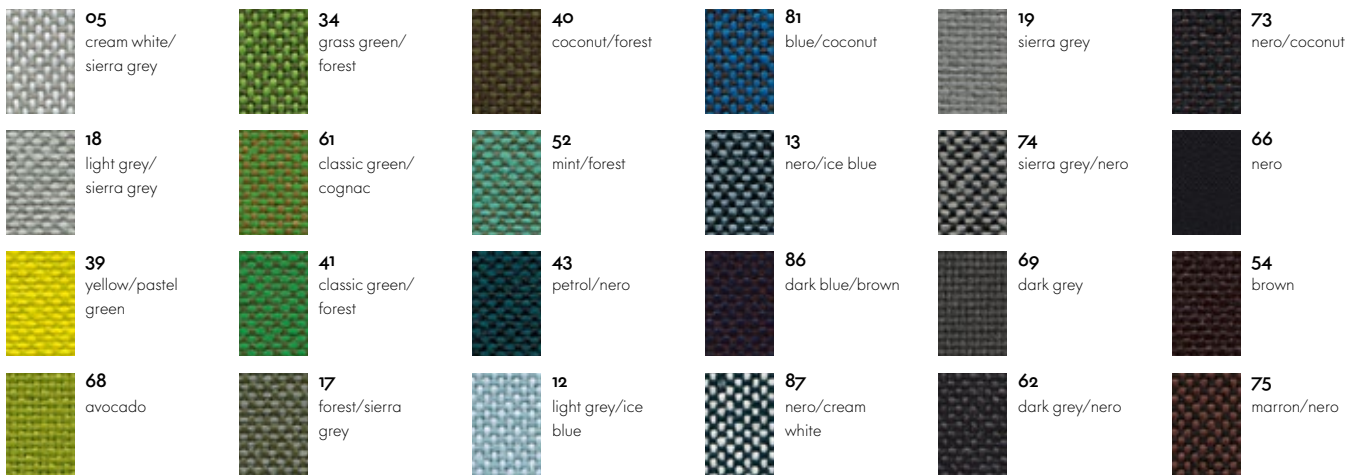

## HAL Seat cover, Plano



# Planum

## Home

**vitra.**

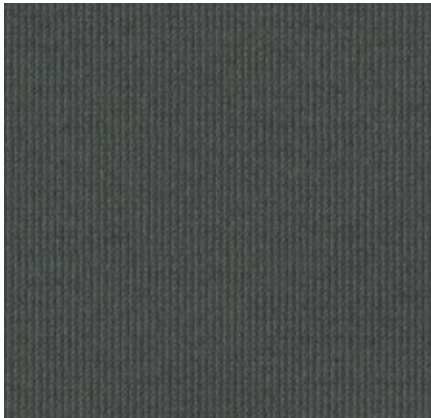

Planum is a hard-wearing, knitted upholstery fabric with a light matt sheen, which gives it a soft appearance. Its fine smooth surface has a dry feel. The knit fabric is suited for private settings as well as public spaces, and can be optimally combined with the multiple shades of the textile Drop.

Planum is available in 3 colours.

Material	14% nylon, 44% new wool, 42% polyester
Weight	400 g/m <sup>2</sup> (11.8 oz/y <sup>2</sup> )
Width	162 cm +/- 2 cm (63'')
Abrasion resistance	100,000 Martindale
Fastness to light	Type 5-6
Pilling	Grade 4
Fastness to rubbing	Grade 4-5 dry and wet

---

## Abalon

---

### Planum



**01**  
silver grey (111)



**02**  
dark green (971)



**03**  
black (1191)

---

# Reed

## Home, F100



The elegant finely patterned fabric Reed is a blend of linen, wool and cotton. The structure of the fabric designed by Hella Jongerius has a hand-made look, its irregular lively linen yarn lending the fabric a natural expression. Reed is cool and soft to the touch and can be perfectly combined with other fabrics and materials.

Reed is available in 19 colours.

Material	7% polyamide, 48% cotton, 25% new wool, 20% linen
Weight	400 g/m <sup>2</sup> (11.8 oz/y <sup>2</sup> )
Width	142 cm +/- 2 cm (56")
Abrasion resistance	50,000 Martindale
Fastness to light	Type 5
Pilling	Grade 3-4
Fastness to rubbing	Grade 3-4 dry and wet

Grand Sofà  
Mariposa Club Armchair  
Mariposa Sofa  
Soft Modular Sofa  
Softshell Chair

Suita

### Reed

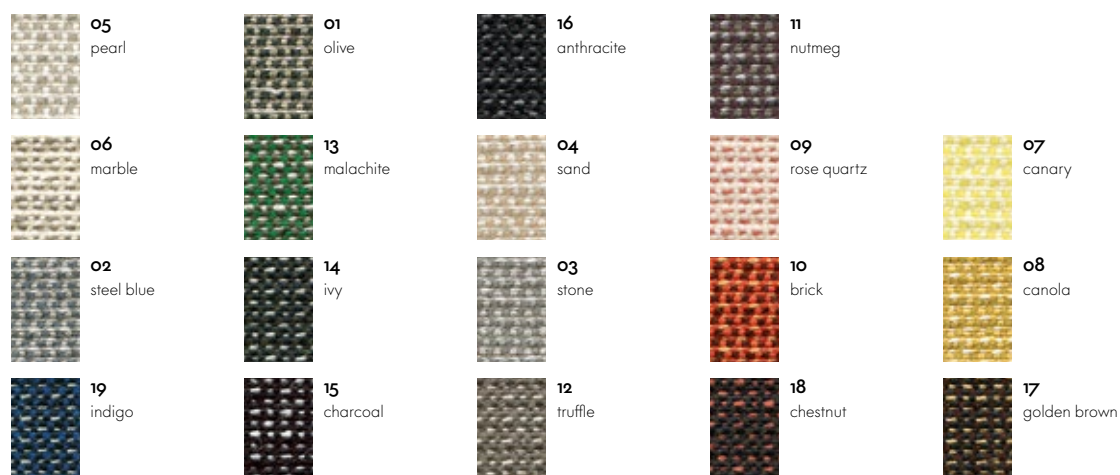

# Reflect

Home/Office, F40

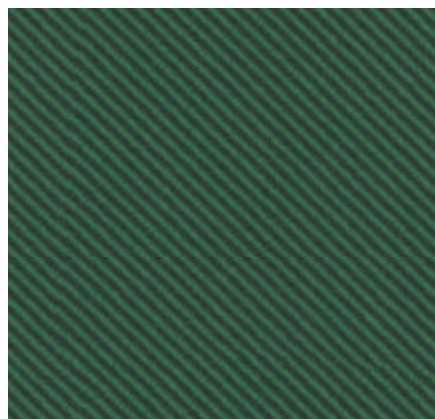

Reflect is a sustainable fabric made of recycled polyester. Its twill weave offers a fine surface texture that is soft to the touch. As a highly robust material, Reflect meets the stringent requirements for use in public spaces.

Hella Jongerius has designed nine colours, which are harmoniously coordinated with the Vitra Colour & Material Library. The Kvadrat palette extends the selection by a further 35 hues. Slight variations in colour may occur.

Material	100% recycled polyester
Weight	310 g/m <sup>2</sup>
Width	142 cm +/- 2 cm (56")
Abrasion resistance	100,000 Martindale
Fastness to light	Type 6
Pilling	Grade 4-5
Fastness to rubbing	Grade 4-5 dry and wet

ID Chair Concept  
ID Visitor

## Reflect



# Savana

## Home, F8o

**vitra.**

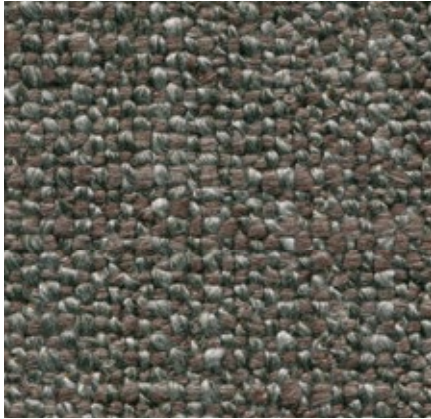

Savana is a blended fabric woven from yarns of varying thickness, which give it an irregular texture with a lively and elegant appearance. A palette of subdued and natural earth tones, along with the dry, pleasant feel of the textile, emphasise the fabric's Italian flair.

Savana is available in 8 colours.

Material	8% polyamide, 19% cotton, 50% polyacrylics, 23% linen
Weight	820 g/m <sup>2</sup> (24.2 oz/y <sup>2</sup> )
Width	140 cm (55")
Abrasion resistance	30,000 Martindale
Fastness to light	Type 5
Pilling	Grade 3-4
Fastness to rubbing	Grade 3-4 dry and wet

Grand Sofà  
Mariposa Club Armchair  
Mariposa Sofa  
Soft Modular Sofa

Suita Club Armchair  
Suita

### Savana



**01**  
pearl melange



**05**  
pebble melange



**02**  
sand melange



**06**  
sierra grey melange



**03**  
mauve melange

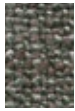

**07**  
nutmeg melange

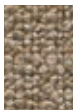

**04**  
papyrus melange

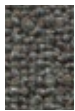

**08**  
graphite melange

# Silk Mesh

Home/Office



Silk Mesh is a three-dimensional spacer fabric. Thanks to the air cells in the regular honeycomb structure, the fabric not only provides a comfortable cushioning effect but also ensures a pleasant seating climate. Silk Mesh is extremely robust and well suited for use in office environments.

Silk Mesh is available in 7 colours.

Allstar  
ID Air  
ID Mesh  
ID Soft  
ID Visitor Air

ID Visitor Mesh  
Unix Chair

Material 100% polyester  
Weight 300 g/m<sup>2</sup> (8.8 oz/y<sup>2</sup>)  
Width 170 cm +/- 3 cm (67")  
Abrasion resistance 40,000 Martindale  
Fastness to light Type 6  
Pilling Grade 4-5  
Fastness to rubbing Grade 4-5 dry and wet

## Silk Mesh



**24**  
soft grey

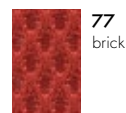

**77**  
brick



**21**  
dim grey

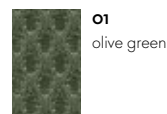

**01**  
olive green

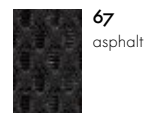

**67**  
asphalt

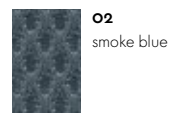

**02**  
smoke blue

Material 33% polyamide,  
67% polyester  
Weight 300 g/m<sup>2</sup> (8.8 oz/y<sup>2</sup>)  
Width 170 cm +/- 3 cm (67")  
Abrasion resistance 100,000 Martindale  
Fastness to light Type 6  
Pilling Grade 4-5  
Fastness to rubbing Grade 4-5 dry and wet

## Silk Mesh

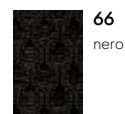

**66**  
nero

## Home

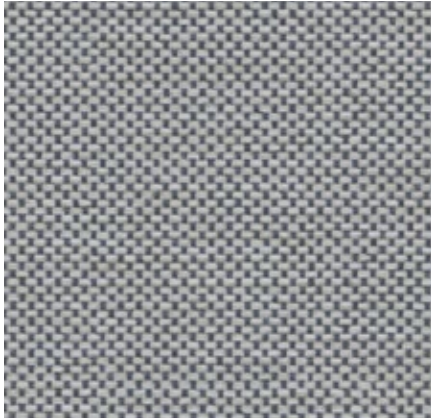

The robust outdoor textile made of polypropylene yarn is characterised by its smooth flat weave. Simmons has antibacterial properties and is resistant to UV light, water and mildew. The fabric dries quickly and can be easily washed and cleaned.

Simmons is available in 3 colours.

Material	83% polypropylene, 17% polyester
Weight	330 g/m <sup>2</sup>
Width	140 cm
Abrasion resistance	30,000 Martindale
Fastness to light	Type 7-8
Pilling	Grade 4-5
Fastness to rubbing	Grade 4-5 dry, Grade 4 wet

---

## Soft Seats

---

### Simmons



**55**  
grau/weiss



**53**  
weiss/stahlblau



**61**  
grau

---



# SingleKnit

Home/Office

**vitra.**



SingleKnit is a precision knit component cover developed specifically for the Pivot office chair. The knit texture of the fabric helps to prevent users from slipping on the seat surface. This robust technical knit is ideally suited for office applications.

SingleKnit is available in 5 colours.

Material	5% spandex, 95% polyester
Weight	475 g/m <sup>2</sup> (14 oz/y <sup>2</sup> )
Abrasion resistance	40,000 Martindale
Fastness to light	Type 6
Pilling	Grade 4-5
Fastness to rubbing	Grade 4-5 dry and wet

Pivot Counter Stool

Pivot High Stool

Pivot Stool

## SingleKnit



**01**  
light grey



**04**  
dark grey



**05**  
black

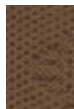

**03**  
brown



**02**  
red

# Striped Knit

Home/Office

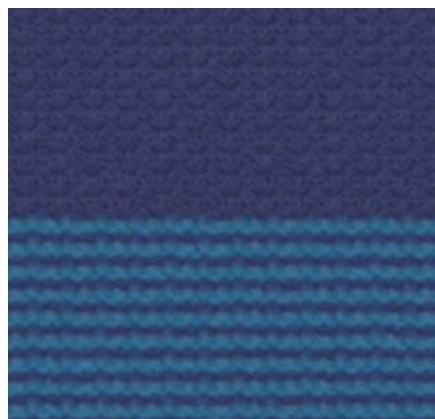

Striped Knit is a form-fitted knit fabric for the backrest of ID Soft. Its lightly textured surface and striped pattern add a fresh home-like accent to any office environment.

Striped Knit exists in a choice of two colour versions.

Material	4% spandex, 96% polyester
Weight	540 g/m <sup>2</sup> +/- 10%
Abrasion resistance	40,000 Martindale
Fastness to light	Type 6
Pilling	Grade 4-5
Fastness to rubbing	Grade 4-5 dry and wet

ID Soft

## Striped Knit

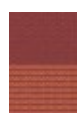

**O1**  
brick/orange



**O2**  
ink blue/turquoise

# Tonus

## Home, F100

**vitra.**



Tonus is a classic woollen cloth in a plain weave with an appealingly soft and flexible feel. The deep intensity of Tonus colours – ranging from warm and earthy golds that evoke oriental myths and spices to cool nordic hues in the aquamarine spectrum – lend a unique richness to the fabric.

Tonus is available in 14 colours.

Material	90% new wool, 10% helanca
Weight	490 g/m <sup>2</sup> (14.5 oz/y <sup>2</sup> )
Width	140 cm (55")
Abrasion resistance	100,000 Martindale
Fastness to light	Type 5
Pilling	Grade 3
Fastness to rubbing	Grade 3-4 dry and wet

## Amoebe Visiona Stool

### Tonus



## Cone Chair Heart Cone Chair

## Organic Chair

## Living Tower

### Tonus



### Tonus

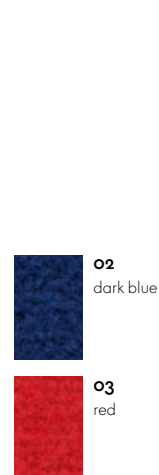

# Track

Home/Office, F120

**vitra.**

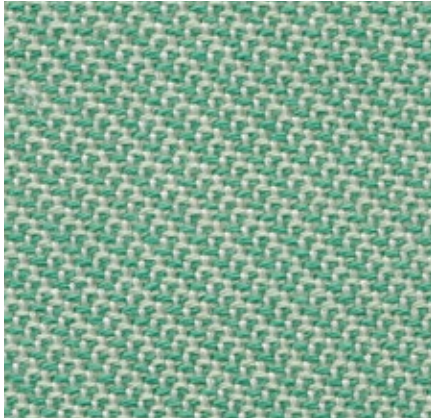

Track is a medium-weight woollen fabric with a subtle pattern of fine diagonal stripes, which gives it a sporty, fresh appearance. Thanks to its high quality, the fabric is suited for office environments, but also adds a beautiful touch to home interiors.

Track is available in 25 colours.

Material	10% polyamide, 90% new wool
Weight	480 g/m <sup>2</sup> (14.2 oz/y <sup>2</sup> )
Width	143 cm +/- 2 cm (56")
Abrasion resistance	100,000 Martindale
Fastness to light	Type 6
Pilling	Grade 4-5
Fastness to rubbing	Grade 4-5 dry and wet

Alcove  
Alcove Plus  
Citizen  
Soft Modular Sofa  
Soft Work

## Track

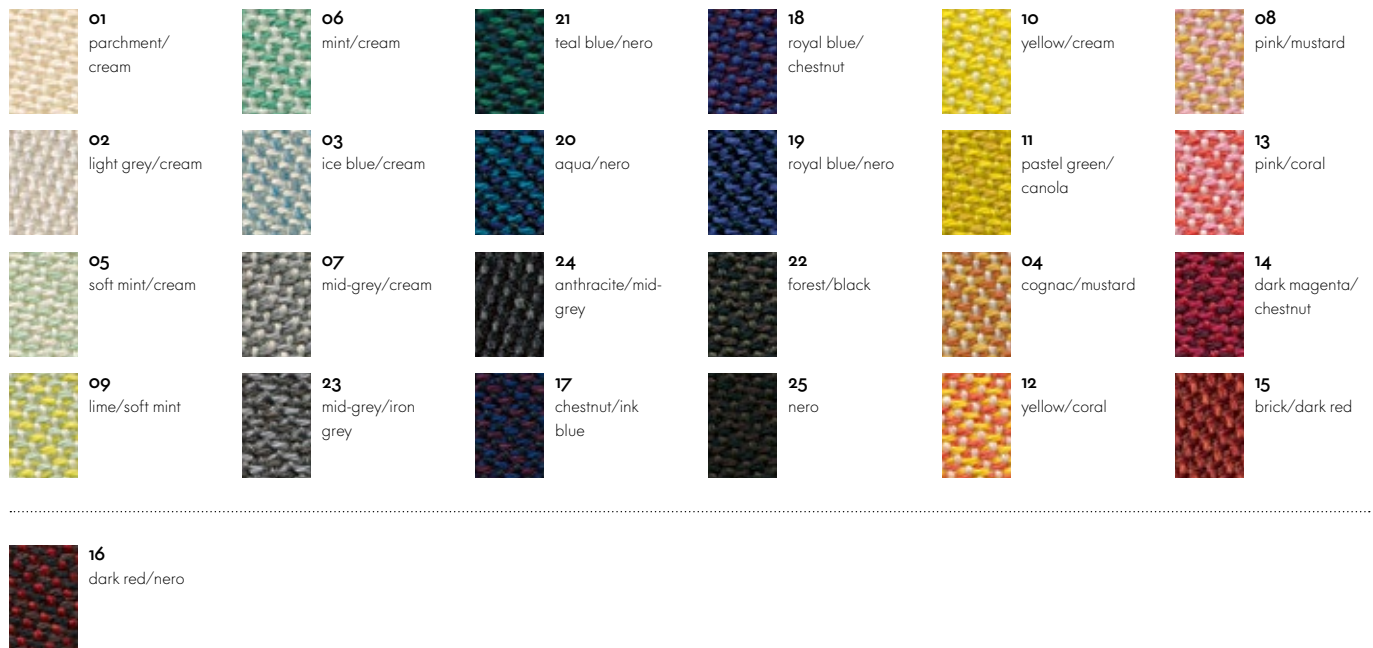

# Tress

Home/Office, F80

**vitra.**

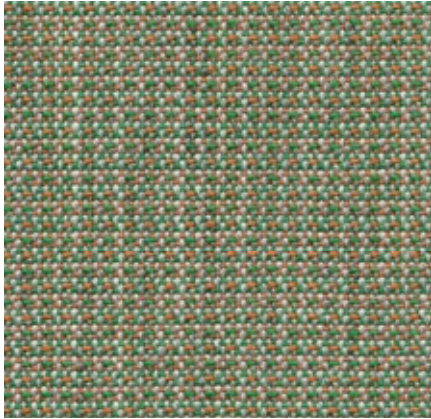

Tress is a flat woven fabric with a lively appearance that derives from the contrast between its even structure and the natural melange of colours. The combination of yarns with varied hues creates a harmonious and yet vibrant look. Thanks to its high wool content, Tress is a durable, easy-care material with a home-like aesthetic.

Tress is available in 22 colours.

Material	8% polyamide, 73% new wool, 19% polyester
Weight	310 g/m <sup>2</sup> (9.1 oz/y <sup>2</sup> )
Width	142 cm +/- 2 cm (56")
Abrasion resistance	40,000 Martindale
Fastness to light	Type 6
Pilling	Grade 4-5
Fastness to rubbing	Grade 4-5 dry and wet

Alcove  
Alcove Plus  
Allstar  
Fauteuil de Salon  
Fauteuil Direction

Fauteuil Direction Pivotant  
Rookie  
Soft Modular Sofa  
Soft Seats  
Softshell Chair

## Tress

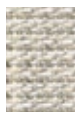

**01**  
light grey  
melange

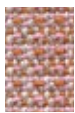

**05**  
pale rose  
melange



**09**  
brown  
melange

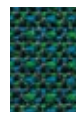

**13**  
teal blue  
melange



**17**  
plum  
melange

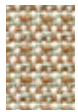

**02**  
papyrus  
melange



**06**  
ice grey  
melange



**10**  
pebble  
melange



**14**  
brandy  
melange



**18**  
royal blue  
melange

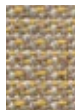

**03**  
camel  
melange



**07**  
emerald  
melange



**11**  
blue-grey  
melange



**15**  
chestnut  
melange



**19**  
blue  
melange



**21**  
anthracite  
melange

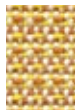

**04**  
canola  
melange



**08**  
aubergine  
melange



**12**  
steel blue  
melange



**16**  
blackberry  
melange



**20**  
mid-grey  
melange



**22**  
black  
melange

# TrioKnit

## Home/Office

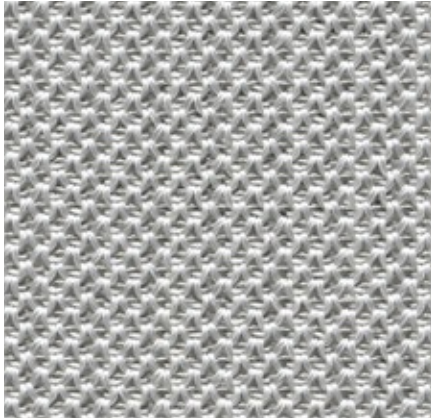

TrioKnit is a strong, self-supporting knit fabric with a fine sheen. The robust quality and slightly technical look of TrioKnit make it well suited for office environments. Thanks to the fabric's subdued colour palette, it can be easily combined with other materials.

TrioKnit is available in 6 colours.

Material	4% spandex, 96% polyester
Weight	607 g/m <sup>2</sup> (17.9 oz/y <sup>2</sup> )
Abrasion resistance	40,000 Martindale
Fastness to light	Type 6
Pilling	Grade 4-5
Fastness to rubbing	Grade 4-5 dry and wet

---

## Physix

---

### TrioKnit



**07**  
silver grey



**09**  
ice grey



**08**  
pebble grey



**10**  
brick



**03**  
reed



**06**  
black pearl

# Twill

**vitra.**

Home/Office, F60

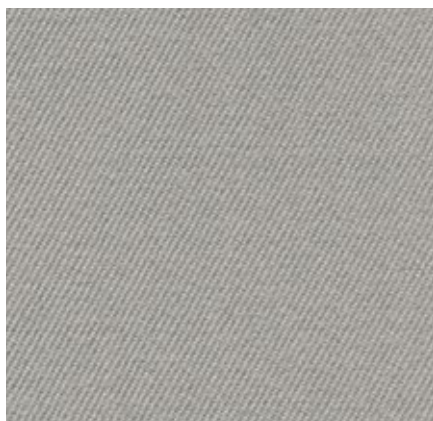

The high percentage of natural fibres gives Twill very pleasant tactile qualities and an inviting appearance. Extremely durable with excellent abrasion resistance, it combines the qualities typically found in home furnishings with the demanding requirements of the project sector.

Twill is available in 18 colours.

Material	30% polyamide, 70% new wool
Weight	325 g/m <sup>2</sup> (9.6 oz/y <sup>2</sup> )
Width	155 cm +/- 2 cm (61")
Abrasion resistance	100,000 Martindale
Fastness to light	Type 6
Pilling	Grade 4-5
Fastness to rubbing	Grade 4-5 dry and wet

AC 5 Group  
Fauteuil de Salon  
Fauteuil Direction  
Fauteuil Direction Pivotant  
ID Chair Concept

ID Visitor  
Rookie  
Soft Seats  
Softshell Chair  
Visiona Stool

## Twill



# Volo

**vitra.**

Home/Office, F60

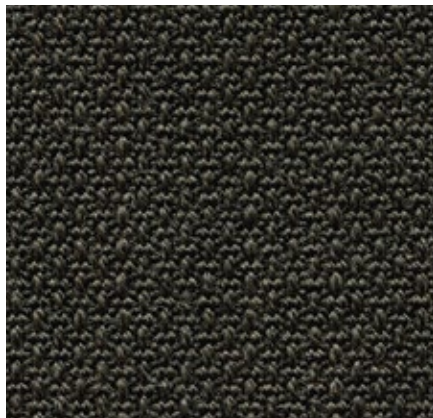

Volo is a finely structured wool blend with a refined weave that gives it an elegant appearance. This expressive textile shows strong solid colours to full advantage while simultaneously offering pleasant tactile qualities. With its soft look and appealing texture, Volo is a perfect fit for home interiors, but it is also well suited for use in the contract sector.

Volo is available in 17 colours.

Material	15% polyamide, 85% new wool
Weight	435 g/m <sup>2</sup> (12.8 oz/y <sup>2</sup> )
Width	145 cm +/- 3 cm (57")
Abrasion resistance	100,000 Martindale
Fastness to light	Type 6
Pilling	Grade 4-5
Fastness to rubbing	Grade 4-5 dry and wet

Alcove  
Alcove Plus  
Allstar  
Amoebe  
Fauteuil de Salon  
Fauteuil Direction  
Fauteuil Direction Pivotant  
HAL Lounge Chair

HAL Soft  
ID Chair Concept  
ID Visitor  
Mariposa Club Armchair  
Mariposa Sofa  
Petit Repos  
Repos & Grand Repos  
Rookie

Soft Modular Sofa  
Soft Seats  
Softshell Chair  
Suita Club Armchair  
Suita Club Sofa  
Suita  
Visiona Stool

## Volo

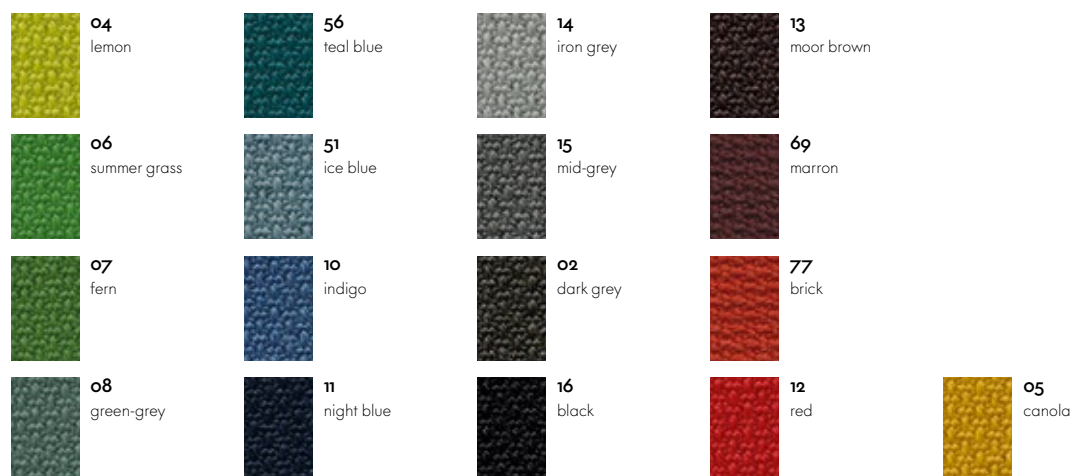



# Overview of cover materials

## Textiles with a price group

		Material	Width	Weight	Abrasion resistance (Martindale)	
F20	Nova	100% polyester	142 cm +/- 2 cm (56")	400 g/m <sup>2</sup> (11.8 oz/y <sup>2</sup> )	60,000	
F30	Plano	100% polyester	142 cm +/- 2 cm (56")	265 g/m <sup>2</sup> (7.8 oz/y <sup>2</sup> )	80,000	
F40	Laser RE	100% recycled polyester	144 cm +/- 2 cm	520 g/m <sup>2</sup>	100,000	
	Mello	80% cotton, 20% polyester	142 cm +/- 2 cm (56")	530 g/m <sup>2</sup> (15.6 oz/y <sup>2</sup> )	30,000	
	Reflect	100% recycled polyester	142 cm +/- 2 cm (56")	310 g/m <sup>2</sup>	100,000	
F60	Hopsak	100% polyamide	127 cm +/- 2 cm (50")	550 g/m <sup>2</sup> (16.2 oz/y <sup>2</sup> )	200,000	
	Olimpo	70% linen, 30% rayon	146 cm +/- 3 cm (57")	520 g/m <sup>2</sup> (15.3 oz/y <sup>2</sup> )	30,000	
	Twill	30% polyamide, 70% new wool	155 cm +/- 2 cm (61")	325 g/m <sup>2</sup> (9.6 oz/y <sup>2</sup> )	100,000	
	Volo	15% polyamide, 85% new wool	145 cm +/- 3 cm (57")	435 g/m <sup>2</sup> (12.8 oz/y <sup>2</sup> )	100,000	
F80	Corsaro	5% polyamide, 10% cotton, 46% polyacrylics, 5% linen, 20% wool, 14% polyester	140 cm +/- 2 cm (55")	450 g/m <sup>2</sup> (13.3 oz/y <sup>2</sup> )	35,000	
	Cosy 2	20% polyamide, 80% new wool	154 cm +/- 2 cm (60")	590 g/m <sup>2</sup> (17.4 oz/y <sup>2</sup> )	50,000	
	Dumet	9% polyamide, 46% cotton, 8% linen, 22% wool, 15% rayon	147 cm +/- 2 cm (57")	485 g/m <sup>2</sup> (14.3 oz/y <sup>2</sup> )	40,000	
	Iroko 2	32% cotton, 48% polyacrylics, 20% polyester	152 cm +/- 3 cm (60")	700 g/m <sup>2</sup> (20.6 oz/y <sup>2</sup> )	40,000	
	Linho	9% polyamide, 91% linen	137 cm +/- 2 cm (54")	450 g/m <sup>2</sup> (13.3 oz/y <sup>2</sup> )	18,000	
	Savana	8% polyamide, 19% cotton, 50% polyacrylics, 23% linen	140 cm (55")	820 g/m <sup>2</sup> (24.2 oz/y <sup>2</sup> )	30,000	
	Tress	8% polyamide, 73% new wool, 19% polyester	142 cm +/- 2 cm (56")	310 g/m <sup>2</sup> (9.1 oz/y <sup>2</sup> )	40,000	
	F100	Aura	3% polyamide, 97% new wool	144 cm +/- 2 cm (56")	390 g/m <sup>2</sup> (11.5 oz/y <sup>2</sup> )	20,000
		Nubia	2% polyamide, 30% new wool, 25% polyacrylics, 43% polyester	140 cm (55")	570 g/m <sup>2</sup> (16.8 oz/y <sup>2</sup> )	35,000
		Reed	7% polyamide, 48% cotton, 25% new wool, 20% linen	142 cm +/- 2 cm (56")	400 g/m <sup>2</sup> (11.8 oz/y <sup>2</sup> )	50,000
Tonus		90% new wool, 10% helanca	140 cm (55")	490 g/m <sup>2</sup> (14.5 oz/y <sup>2</sup> )	100,000	
F120	Credo	5% polyamide, 95% new wool	145 cm +/- 2 cm (57")	640 g/m <sup>2</sup> (18.9 oz/y <sup>2</sup> )	100,000	
	Track	10% polyamide, 90% new wool	143 cm +/- 2 cm (56")	480 g/m <sup>2</sup> (14.2 oz/y <sup>2</sup> )	100,000	
F200	Checker	77% cotton, 23% polyester	140 cm (55")	467 g/m <sup>2</sup> (13.8 oz/y <sup>2</sup> )	20,000	

## Textiles with no price group

	Material	Width	Weight	Abrasion resistance (Martindale)
Coda	10% nylon, 90% new wool	140 cm (55")	860 g/m <sup>2</sup> (25.4 oz/y <sup>2</sup> )	100,000
Diamond Mesh	100% polyester	165 cm (64")	600 g/m <sup>2</sup> (17.7 oz/y <sup>2</sup> )	45,000
Drop	20% nylon, 60% new wool, 20% polyester	157 cm +/- 2 cm (61")	520 g/m <sup>2</sup> (15.3 oz/y <sup>2</sup> )	80,000
FleeceNet	46% polyamide, 1% spandex, 53% polyester	135 cm +/- 2 cm (53")	430 g/m <sup>2</sup> (12.7 oz/y <sup>2</sup> )	100,000
Intreccio	23% cotton, 77% new wool	140 cm (55")	780 g/m <sup>2</sup> (23 oz/y <sup>2</sup> )	18,000
LightNet	60% polyamide, 40% polyester	125 cm +/- 3 cm (49")	380 g/m <sup>2</sup> (11.2 oz/y <sup>2</sup> )	100,000
Netweave Aluminium Chair	71% polyurethane, 29% polyester	138 cm (54")	630 g/m <sup>2</sup> (18.6 oz/y <sup>2</sup> )	n/a
Planum	14% nylon, 44% new wool, 42% polyester	162 cm +/- 2 cm (63")	400 g/m <sup>2</sup> (11.8 oz/y <sup>2</sup> )	100,000
Silk Mesh nero	33% polyamide, 67% polyester	170 cm +/- 3 cm (67")	300 g/m <sup>2</sup> (8.8 oz/y <sup>2</sup> )	100,000
Silk Mesh colours	100% polyester			40,000
Simmons	83% polypropylene, 17% polyester	140 cm	330 g/m <sup>2</sup>	30,000
Vinyl ETS	15% cotton, 85% PVC	140 cm (55")	1,230 g/m <sup>2</sup> (36.3 oz/y <sup>2</sup> )	n/a
Duo Knit	4% spandex, 96% polyester		540 g/m <sup>2</sup> +/- 10%	40,000 Martin-
Netline	100% polyester		360 g/m <sup>2</sup> (10.6 oz/y <sup>2</sup> )	40,000 Martin-
SingleKnit	5% spandex, 95% polyester		475 g/m <sup>2</sup> (14 oz/y <sup>2</sup> )	40,000 Martin-
Striped Knit	4% spandex, 96% polyester		540 g/m <sup>2</sup> +/- 10%	40,000 Martin-
Tricot Slow Chair	100% polyester		607 g/m <sup>2</sup> (17.9 oz/y <sup>2</sup> )	40,000 Martin-
TrioKnit	4% spandex, 96% polyester		607 g/m <sup>2</sup> (17.9 oz/y <sup>2</sup> )	40,000 Martin-

Kvadrat fabrics are a further addition to Vitra's collection of durable, high-quality textiles. This expanded range makes it even easier to find the ideal upholstery fabric for a selected piece of Vitra furniture. The colours of the Kvadrat fabrics have been carefully chosen to match other Vitra surface finishes, offering a multitude of harmonious combinations. The complete colour palette of Kvadrat fabrics can be viewed at [Kvadrat.dk](https://www.kvadrat.dk).



**Canvas 2, F60**

This textile has a pronounced structure, making it especially suited for large surfaces.

The colours owe their exceptional richness to the use of up to six differently hued yarns per colour.

Hard-wearing and durable.

Canvas 2 is available in 45 colours.

*Material*

10% nylon, 90% new wool



**Divina 3, F120**

Piece-dyed, supple fabric with a directionless, smooth and uniform surface. The regular surface enhances the purity of the colours.

Hard-wearing and durable.

Divina 3 is available in 56 colours.

*Material*

100% new wool

**Divina MD**, F120

Supple material-dyed fabric with a smooth, directionless and consistent surface. Its full-bodied and subtle structure brings the nuanced range of colours to life and creates a vibrant appearance. Hard-wearing and durable.

## Material

100% new wool

Divina MD is available in 27 colours.

---

**Divina Melange 3**, F120

Piece-dyed, supple fabric with a directionless, smooth and uniform surface. The lively melange effect is created by mixing undyed and black-dyed woollen yarns and then piece-dyeing after the weaving process. This creates a unique, dynamic look. Hard-wearing and durable.

## Material

100% new wool

Divina Melange 3 is available in 38 colours.

---

**Hallingdal 65**, F140

Wool gives this material excellent durability and flexibility, while viscose enhances the brilliance and depth of the colours. A classic, timeless fabric in a wide selection of hues. Hard-wearing and durable.

## Material

70% new wool, 30% rayon

Hallingdal 65 is available in 58 colours.

---

**Steelcut Trio 3**, F100

The innovative weave of this fabric creates a complex three-dimensional surface, and the combination of three different hues adds to its vibrant appearance.

Hard-wearing and durable.

Steelcut Trio 3 is available in 54 colours.

*Material*

10% nylon, 90% new wool

---

**Remix 3**, F80

The tight plain weave creates a subtle, minimalist surface texture. Each hue comprises a combination of up to six differently coloured yarns, yielding exceptional depth of colour.

Hard-wearing and durable.

Remix 3 is available in 72 colours.

*Material*

10% nylon, 90% new wool

---

**Tonus 4**, F100

Thanks to the structural properties of Helanca yarn, Tonus is elastic and well suited for modern organic furniture. It brings colours to life in vibrant, precise fashion.



























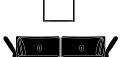

Hard-wearing and durable.

Tonus 4 is available in 47 colours.

*Material*

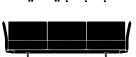
90% new wool, 10% helanca

---

	Canvas 2	Diving 3	Divina Melange 3	Divina MD	Hallingdal 65	Remix 3	Steelcut Trio 3	Tonus 4
 AC 5 Work	•					•	•	
 Alcove Sofa Plus, Alcove Sofa	•	•	•	•	•	•	•	•
 Allstar	•	•	•	•	•	•		•
 AM Chair	•					•		
 Amoebe		•	•	•			•	•
 Dancing Wall	•	•	•			•	•	•
 EPA Full upholstery					•			
 EPC Full upholstery					•		•	•
 EPA & EPC Seat upholstery	•	•	•	•	•	•	•	•
 Fauteuil de Salon/ Fauteuil Direction	•	•	•	•	•	•	•	•
 HAL Lounge Chair		•	•	•				•
 HAL seat upholstery	•	•	•	•	•	•	•	•
 HAL Soft	•	•	•	•	•	•	•	•
 ID Soft, ID Mesh / ID Air / ID Cloud seat only	•	•	•	•	•	•	•	•
 ID Trim / ID Trim L	•				•	•	•	
 ID Visitor Soft, ID Visitor Mesh/Air seat only	•	•	•	•	•	•	•	•
 ID Visitor Trim	•				•	•	•	
 Mariposa		•	•	•			•	•
 Mariposa Club Armchair		•	•	•			•	•
 Organic Chair		•	•	•			•	•
 Repos / Grand Repos		•	•	•			•	•
 Petit Repos		•	•	•			•	•
 Rookie	•				•	•	•	•
 Soft Modular Sofa		•	•	•	•	•	•	•
 Softshell Chair	•	•	•	•	•	•	•	•
 Soft Work		•	•	•			•	•
 Suita / Suita Club		•	•	•			•	•
 Visiona Stool	•	•	•	•	•	•	•	•
 Wire Chair		•	•	•			•	
 Workbays		•	•		•	•	•	

# Leather

## Home/Office, L20



The standard grade leather used by Vitra is a robust cowhide leather, dyed-through, pigmented and embossed with an even grain pattern. Since it is hard-wearing and easy to maintain, it can also be used in office environments.

Leather is available in 16 colours.

Material	Robust cowhide with a distinctive, even grain
Fastness to light	Type 6
Thickness	1.1–1.3 mm
Fastness to rubbing	Grade 4 dry and wet

AC 5 Group  
Allstar  
Citizen  
Coconut Chair  
Eames Tandem Seating ETS  
ID Trim/Trim L  
ID Visitor Soft

Lobby Chair  
MedaSlim  
Rookie  
Soft Modular Sofa  
Soft Pad Chaise  
Soft Seats  
Softshell Chair

Suita Club Armchair  
Suita Club Sofa  
Suita

### Leather



### Elephant Pad

### Plywood Group

### Leather



### Cover material (LCM Leather, LCW Leather)



Grand Executive & Grand Conference  
 Petit Repos  
 Repos & Grand Repos

Leather (contrast seam)

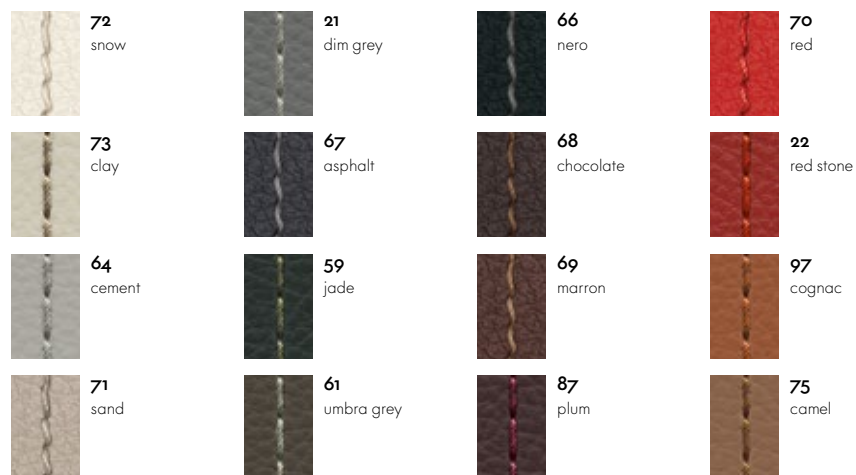

Eames Aluminium Group  
 Eames Soft Pad Group

Leather/back panel Plano





Wire Chair

Leather/back panel  
Leather

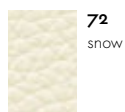

**72**  
snow

Leather/back panel Plano



**73/03**  
clay/parch-  
ment/cream  
white



**64/05**  
cement/ cream  
white/sierra  
grey



**71/80**  
sand/coffee



**21/19**  
dim grey/sierra  
grey



**67/69**  
asphalt/dark  
grey



**59/40**  
jade/ coconut/  
forest



**61/69**  
umbra grey/  
dark grey

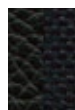

**66/66**  
nero/nero



**68/54**  
chocolate/  
brown

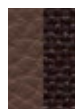

**69/54**  
marron/brown



**87/54**  
plum/brown



**70/72**  
red/poppy red



**22/96**  
red stone/ red/  
cognac



**97/67**  
cognac/cognac



**75/80**  
camel/coffee

# Leather Premium F

Home/Office, L50



Leather Premium F is a relatively smooth cowhide leather with a flat grain and fine top sheen. It is dyed-through, lightly pigmented and processed with a tanning agent extracted from olive tree leaves (a waste product of the olive harvest). Leather Premium F is available in 22 colours.

Material	Semi-aniline nappa leather with a very soft and supple feel, vegetable tanned
Fastness to light	Type 5
Thickness	1.1-1.3 mm
Fastness to rubbing	Grade 4 dry and wet

AC 5 Work  
Cité  
Citizen  
Coconut Chair  
Fauteuil de Salon

Fauteuil Direction & Pivotant  
Grand Relax  
HAL Lounge Chair  
Lobby Chair  
Soft Modular Sofa

Soft Seats  
Softshell Chair  
Suita  
Suita Club Armchair  
Suita Club Sofa

## Leather Premium F



## Eames Aluminium Group

## Eames Soft Pad Group

### Leather Premium F/back panel Plano



Grand Executive & Grand Conference  
 Petit Repos  
 Repos & Grand Repos

Soft Pad Chaise

Leather Premium F (contrast seam)



Lounge Chair

Leather Premium F  
 (Santos palisander)



Leather Premium F  
 (black-pigmented walnut)



Leather Premium F  
 (white-pigmented walnut)



Lounge Chair

Leather Premium F  
(American cherry)

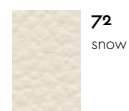

72  
snow

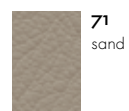

71  
sand



61  
umbra grey

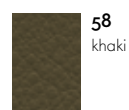

58  
khaki

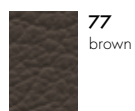

77  
brown

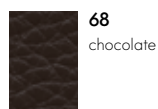

68  
chocolate

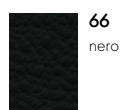

66  
nero

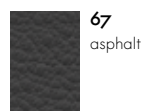

67  
asphalt

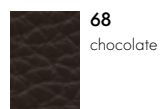

68  
chocolate

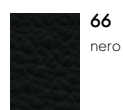

66  
nero

Wire Chair

Leather Premium F/back panel Leather Premium F

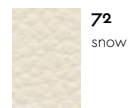

72  
snow

Leather Premium F/back panel Plano



64/05  
cement/ cream  
white/sierra  
grey



58/40  
khaki/ coconut/  
forest

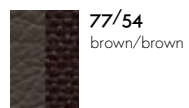

77/54  
brown/brown

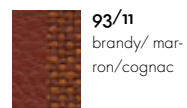

93/11  
brandy/ mar-  
ron/cognac

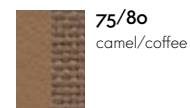

75/80  
camel/coffee



65/19  
granite/sierra  
grey



61/69  
umbra grey/  
dark grey

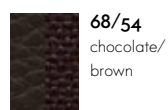

68/54  
chocolate/  
brown



22/96  
red stone/ red/  
cognac



62/80  
ochre/coffee



60/69  
smoke blue/dark  
grey

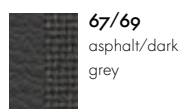

67/69  
asphalt/dark  
grey

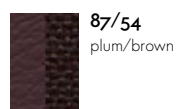

87/54  
plum/brown

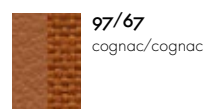

97/67  
cognac/cognac

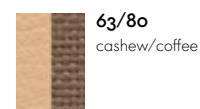

63/80  
cashew/coffee



59/40  
jade/ coconut/  
forest

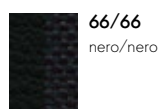

66/66  
nero/nero



69/54  
marron/brown

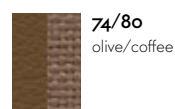

74/80  
olive/coffee

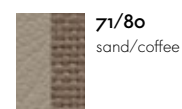

71/80  
sand/coffee



73/70  
clay/stone

# Leather Natural F

## Home, L6o



Leather Natural F is a very soft cowhide leather with an untreated grain. It is porous, breathable and acquires a lively patina through use. It is processed with a tanning agent extracted from olive tree leaves (a waste product of the olive harvest), and any chemicals used are harmless and applied in the smallest possible amounts.

Material

Aniline nappa leather with a natural open-pore grain, vegetable tanned

Fastness to light

Type 3

Thickness

1.1–1.3 mm

This sustainable aniline leather exists in a choice of 4 colours.

Petit Repos  
Suita

Repos & Grand Repos

### Leather Natural F

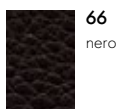
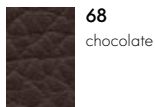
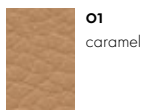
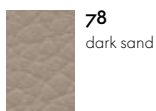

### Leather Natural F (contrast seam)

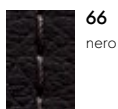
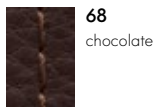
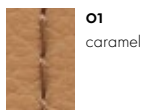

### Lounge Chair

Leather Natural F (American cherry, Santos palisander, black-pigmented walnut)

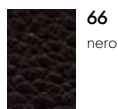
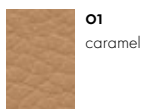
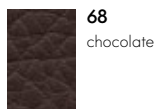
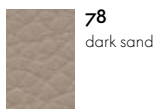

Leather Natural F (white-pigmented walnut)

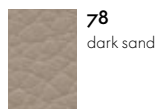

Leather Natural F (black ash)

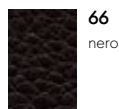
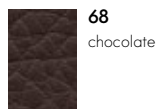

# Leather Forte (deco)

Home/Office, L20



Leather Forte (deco) is of the same quality as Leather Forte, but features a decorative finish that is applied to the leather in a patented process. Leather Forte (deco) is available in 6 colours.

Material	Split leather with decorative finish
Fastness to light	Type 6
Thickness	1.8–2.0 mm

Grand Relax  
Sofa Tray

## Leather Forte (deco)



**07**  
sand

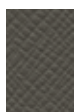

**03**  
umbra grey



**01**  
cognac (dark)



**04**  
chocolate

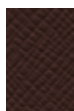

**02**  
marron (dark)



**05**  
nero

# Leather Liso

Home/Office, L10

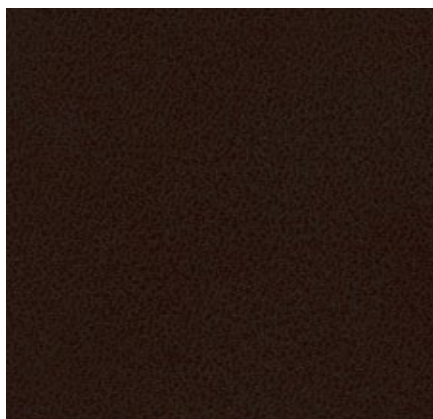

Leather Liso has a clean, smooth surface finish that gives it a contemporary appearance. Highly durable with good wear properties, this split leather comes in 2 colours.

Material  
Fastness to light

Split leather  
Type 6

Thickness

1.8–2.0 mm

---

Meda Gate

---

## Leather Liso



**66**  
nero

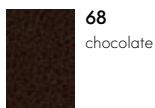

**68**  
chocolate

---

# Overview of cover materials

## Leathers with a price group

		Material	Thickness
L10	Leather Liso	Split leather	1.8–2.0 mm
L20	Leather Forte (deco)	Split leather with decorative finish	1.8–2.0 mm
	Leather	Robust cowhide with a distinctive, even grain	1.1–1.3 mm
L50	Leather Premium F	Semi-aniline nappa leather with a very soft and supple feel, vegetable tanned	1.1–1.3 mm
L60	Leather Natural F	Aniline nappa leather with a natural open-pore grain, vegetable tanned	1.1–1.3 mm



Vitra uses a variety of high-quality plastics for its furniture products, depending on the desired characteristics. Special additives are employed in the manufacture of outdoor products to retard the fading of colours caused by UV radiation.

When it comes to plastics, it is always important to consider whether newer, more environmentally sensible alternatives are available. For this reason, four different plastics have been used in the production of the Panton Chair since 1967. The plastics most often used by Vitra are polypropylene and polymide, both of which are recyclable thermoplastics.

AC 5 Group  
**Base AC 5 Studio, Work**

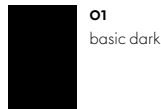

Pivot High Stool  
 Pivot Stool  
**Base**

MedaSlim  
**Backrest, seat and front legs**

AM Chair  
**Base, armrests and back bracket**

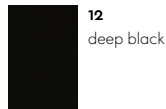

Allstar  
**Base**

Algue

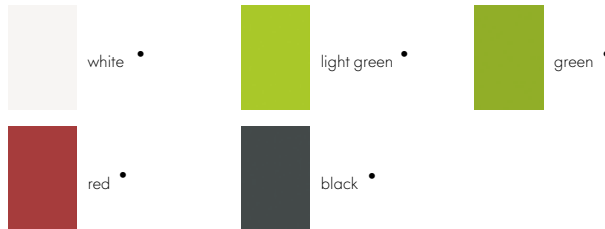

All Plastic Chair

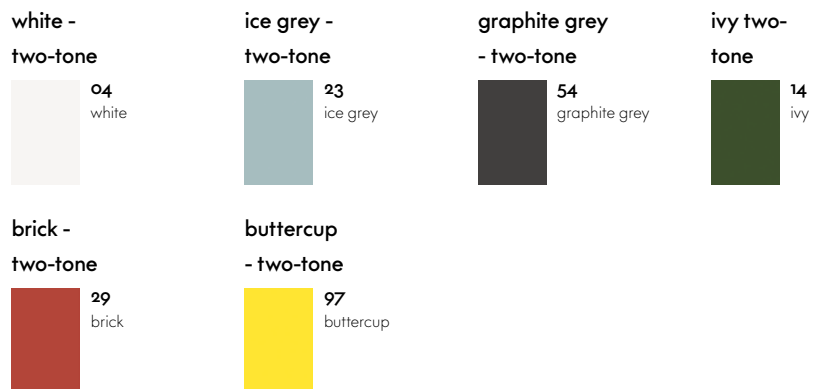

Allstar  
**Armrests/back bracket**



Belleville Chair  
Seat shell Plastic

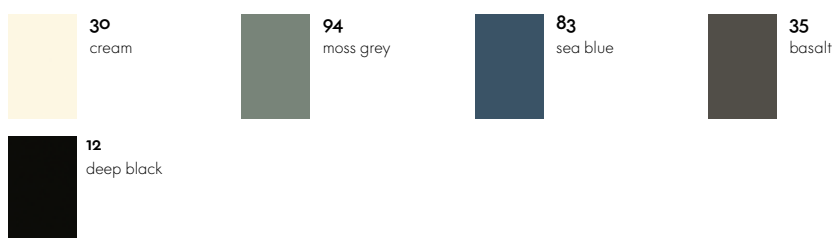

Corniches



Eames Elephant  
Eames Elephant (Small)

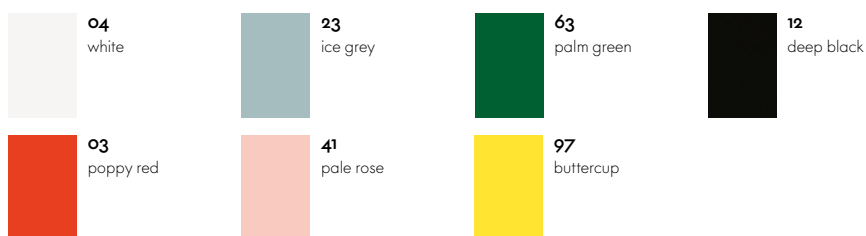

Eames Plastic Chairs  
Seat shell

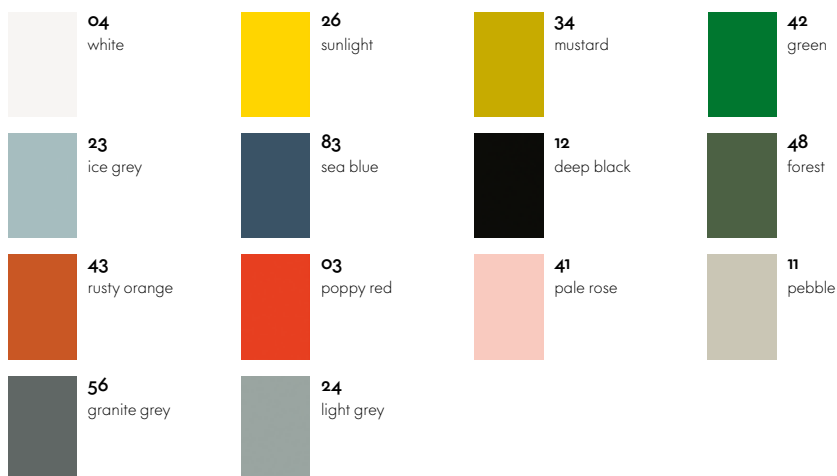

Elephant Stool

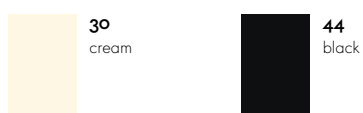

EVO-C



Happy Bin

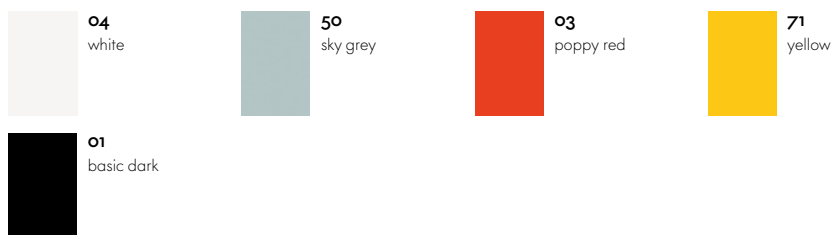

ID Air  
ID Air Visitor  
Backrest

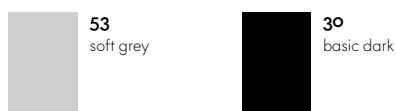

ID Chair Concept  
Frame (armrests, back  
bracket, mechanical unit)

Unix Chair  
Frame

ID Chair Concept  
Base



Softshell Chair  
Four legged base

La Chaise  
Seat shell

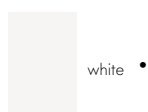

O-Tidy  
S-Tidy



Panton Chair

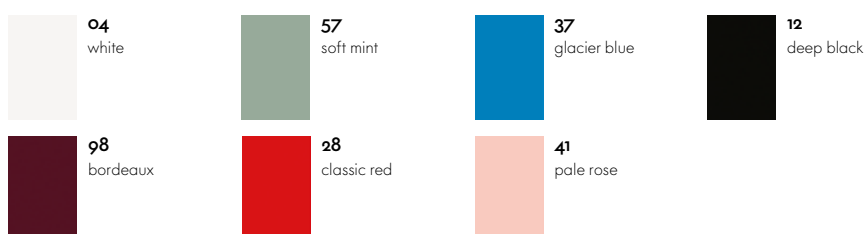

Panton Chair Classic

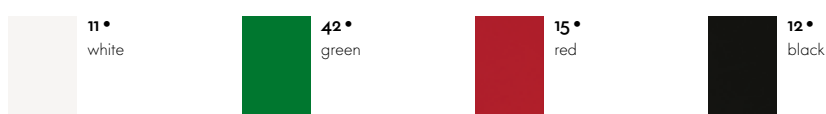

Panton Junior

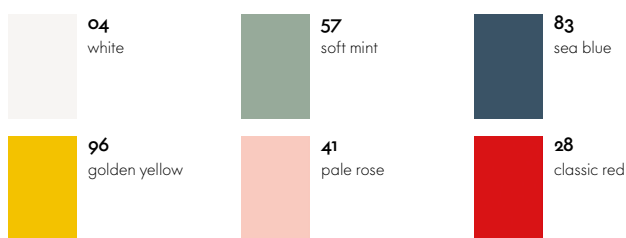

Physix

Frame



Rookie

Base and frame

Seat shell

Standard SP

Back and seat

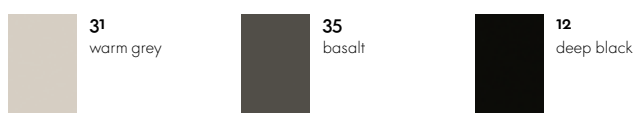

Stool-Tool



Tip Ton

Plastic chair

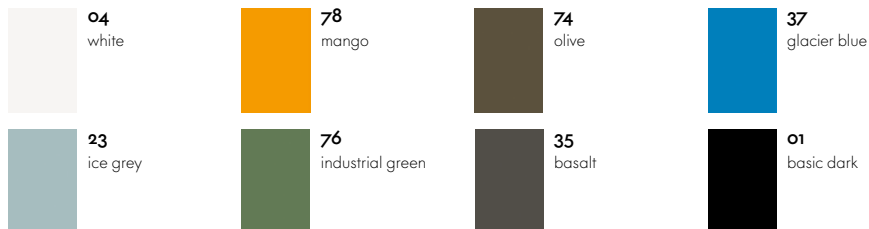

Toolbox

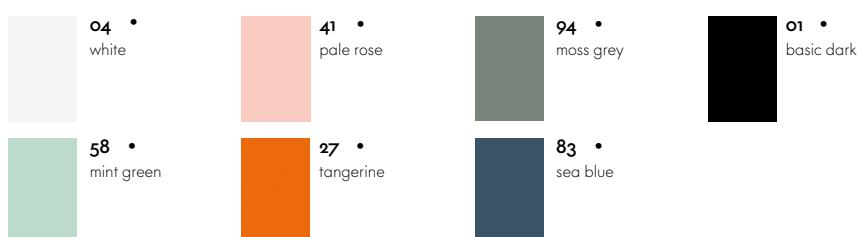

Uten.Silo

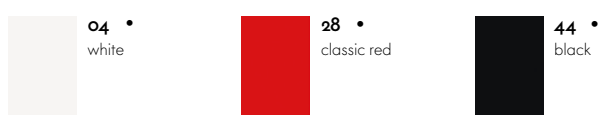

# Recycled plastic

Depending on the material properties required of a product, Vitra chooses different types of plastic for the manufacture of its furniture. This always raises the issue of whether new, more ecological alternatives are available, which has led to the development of various recycled plastics. Depending on the type of product and its requirements, Vitra utilises high-quality recycling materials that stem from recyclable household waste, especially used packaging, or industrial waste.

With plastic obtained from recycled household waste, the natural shade of the processed material is dark grey (22 dark grey RE), interspersed with tiny specks of pigment. All other colours are obtained with artificial dye – and yet due to its randomly variable composition each batch of processed waste material has a different base shade, which can result in colour nuances in the dyed end products.

Chap  
Chap Tray  
Locker Box

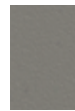

**22**  
dark grey RE



**12**  
deep black RE



**83**  
sea blue RE



**29**  
brick RE

HAL RE  
Seat shell



**31**  
warm grey RE

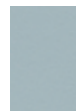

**23**  
ice grey RE

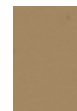

**86**  
cardboard RE



**35**  
basalt RE

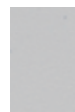

**85**  
cotton white RE



**14**  
ivy RE



**29**  
brick RE



**12**  
deep black RE

Tip Ton RE  
all-plastic chair

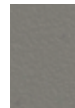

**22**  
dark grey RE

Toolbox RE



**58 •**  
mint green RE



**94 •**  
moss grey RE



**41 •**  
pale rose RE

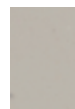

**05 •**  
grey RE



**83 •**  
sea blue RE



**27 •**  
tangerine RE



**01 •**  
basic dark RE

Fibreglass is a very robust and durable fibre composite made of polyester resin and glass fibres. The glass fibres visible in the plastic lend it a lively surface texture with a lustrous reflection and pleasant tactile qualities. This so-called 'fibreprint' may not only vary between different products but can also be a distinguishing characteristic of individual models of the same product. These tiny irregularities and distinctive features are what make each object a unique piece.

When manufacturing fibreglass, Vitra uses materials from Central Europe to avoid long transport distances.

---

## Eames Fibreglass Side Chair Seat shell



**05**  
Eames Sea  
Foam Green



**06**  
Eames Raw  
Umber



**04**  
Eames Elephant  
Hide Grey



**02**  
Eames Navy  
Blue



**09**  
Eames Classic  
Red



**03**  
Eames Red  
Orange



**08**  
Eames Ochre  
Dark



**07**  
Eames Ochre  
Light



**01**  
Eames Parch-  
ment

---

## Eames Fibreglass Armchair Seat shell



**01**  
Eames Parch-  
ment



**05**  
Eames Sea  
Foam Green



**06**  
Eames Raw  
Umber













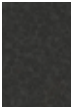
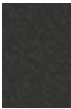
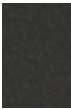

**04**  
Eames Elephant  
Hide Grey

# Polyurethane

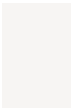
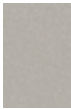
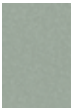
Polyurethane (PU) is a synthetic foam material used in a number of Vitra products. The cellular structure of PU foams can be varied to meet different requirements, ranging from flexible, elastic materials to solid, rigid components.

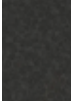
---

.03 .04 .04 Counter <b>Seat shell</b>	 <b>78</b> mango	 <b>10</b> bright red	 <b>77</b> dark green	 <b>01</b> basic dark
.05 <b>Seat shell</b>	 <b>10</b> bright red	 <b>77</b> dark green	 <b>01</b> basic dark	
AIRLINE <b>Back and seat</b>	 <b>01</b> basic dark			
Meda Gate <b>Seat shell, polyurethane</b>	 <b>01</b> basic dark	 <b>40</b> chocolate		
NesTable <b>Tray</b>	 <b>52</b> • soft light	 <b>42</b> • warm grey	 <b>57</b> • soft mint	 <b>23</b> • ice grey
	 <b>19</b> • sea blue	 <b>01</b> • basic dark	 <b>10</b> • bright red	

---

Vitra most frequently uses aluminium and steel for metal components. Since 94% less energy is required to produce recycled aluminium in comparison to primary aluminium, Vitra utilises aluminium consisting of 95% recycled material whenever possible.

Depending on the product, metal surfaces are either powder-coated, chrome-plated, polished, galvanised or lacquered. A smooth or textured powder-coated finish provides colour and surface protection.

.03  
**Base**

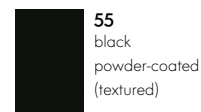
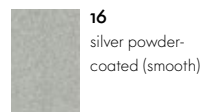
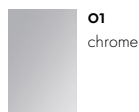

.04  
**Base**

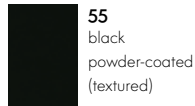

.05  
**Base**

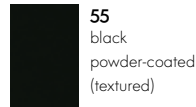
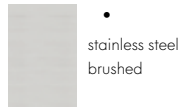

Abalon  
Abalon Table  
**Base**

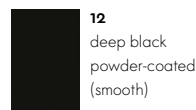

AIRLINE  
**Base and armrests**



AC 5 Group  
**Base and armrests**



Pivot Counter Stool  
Pivot High Stool  
Pivot Stool  
Grand Executive & Grand Conference  
Unix Chair  
**Base**



Alcove  
Alcove Plus  
**Tubular steel frame group 1**

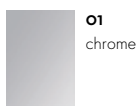

**01**  
chrome

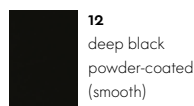

**12**  
deep black  
powder-coated  
(smooth)

**Tubular steel frame group 2**

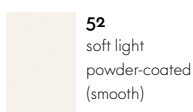

**52**  
soft light  
powder-coated  
(smooth)



**91**  
mint powder-  
coated (smooth)



**32**  
dark grey  
powder-coated  
(smooth)



**06**  
Japanese red  
powder-coated  
(smooth)

AM Chair  
Belleville Table  
**Base**  
Citizen  
**Tubular steel frame**

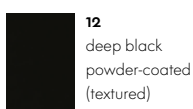

**12**  
deep black  
powder-coated  
(textured)

Bistro Table  
HAL Armchair Studio  
HAL Studio  
Super Fold Table  
Trapèze  
**Base**

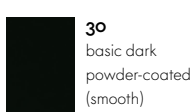

**30**  
basic dark  
powder-coated  
(smooth)

Cité  
Compas Direction  
EM Table  
Fauteuil de Salon  
Fauteuil Direction  
Fauteuil Direction Pivotant  
**Base/Base frame**

**Colour group 1**



**88**  
Prouvé Blanc  
Colombe (Ecrû)  
powder-coated  
(smooth)



**06**  
Japanese red  
powder-coated  
(smooth)

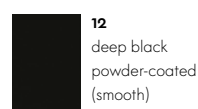

**12**  
deep black  
powder-coated  
(smooth)

**Colour group 2**



**13**  
Prouvé Gris  
Vermeer powder-  
coated (smooth)



**18**  
Prouvé Blé Vert  
powder-coated  
(smooth)

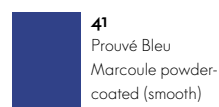

**41**  
Prouvé Bleu  
Marcoule powder-  
coated (smooth)



**14**  
Prouvé Bleu  
Dynastie powder-  
coated (smooth)



**94**  
Prouvé Métal Brut  
powder-coated  
(transparent,  
smooth)

Coconut Chair  
Eames Tandem Seating ETS  
HAL Armchair Tube Stackable  
Home Desk  
La Chaise  
Lobby Chair  
**Base**

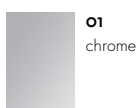

**01**  
chrome

Eames Aluminium Group  
Eames Soft Pad Group  
**Base**

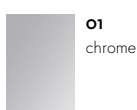

**01**  
chrome

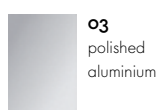

**03**  
polished  
aluminium

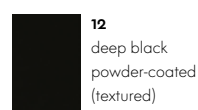

**12**  
deep black  
powder-coated  
(textured)





Eames Contract Tables

**Base**

 <b>04</b> white powder-coated (textured)	 <b>01</b> chrome	 <b>03</b> polished alumi- nium
 <b>12</b> deep black powder-coated (textured)	 <b>30</b> basic dark powder-coated (smooth)	



Eames Desk Unit EDU  
Eames Storage Unit ESU

**Panels**

 <b>83</b> • pale blue	 <b>25</b> • mauve grey	 <b>85</b> • fawn	 <b>84</b> • Eames red
 <b>86</b> • rusty orange			

Eames Fiberglass Chairs

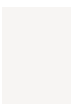
**Base DSR, DSX,  
DAR, DAX, LAR**

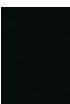
 <b>04</b> white powder- coated (smooth)	 <b>01</b> chrome	 <b>30</b> basic dark powder-coated (smooth)
---	---	--

Eames Plastic Chairs

**Base DAL, PACC, PSCC**

 <b>03</b> polished alumi- nium
---





Eames Plastic Chairs

**Base (Outdoor)**

 <b>04</b> white powder- coated (smooth)	 <b>30</b> basic dark powder-coated (smooth)			
 <b>92</b> citron powder- coated (smooth)	 <b>93</b> sky blue powder- coated (smooth)	 <b>31</b> Eames Sea Foam Green powder- coated (smooth)	 <b>24</b> dark green powder-coated (smooth)	

Eames Segmented Tables Dining  
Eames Segmented Tables Meeting

**Base**

 <b>01</b> chrome	 <b>03</b> polished alumi- nium	 <b>12</b> deep black powder-coated (textured)	 <b>30</b> basic dark powder-coated (smooth)
---	--	--	--



Elliptical Table ETR  
Plywood Group (DCM, LCM)

**Base**

 <b>01</b> chrome	 <b>30</b> basic dark powder-coated (smooth)
---	--

Grand Relax  
Grand Sofà  
Petit Repos  
Repos & Grand Repos  
Suita

**Base**

 <b>03</b> polished alumi- nium	 <b>30</b> basic dark powder-coated (smooth)
--	--

Guéridon  
Guéridon Bas  
Table S.A.M. Bois  
Tabouret Bois  
**Linking elements**



**12**  
deep black  
powder-coated  
(smooth)

HAL  
**Base**



**01**  
chrome



**30**  
basic dark  
powder-coated  
(textured)



**49**  
ivory powder-  
coated (textured)

HAL Soft  
Moca  
**Base**



**01**  
chrome



**30**  
basic dark  
powder-coated  
(textured)

ID Chair Concept  
**Base and ring armrests**



**03**  
polished  
aluminium



**53**  
soft grey  
powder-coated  
(textured)



**30**  
basic dark  
powder-coated  
(textured)

ID Chair Concept  
**Supports for 2D/3D armrests**



**03**  
polished  
aluminium



**53** •  
soft grey  
powder-coated  
(smooth)



**30**  
basic dark  
powder-coated  
(smooth)

ID Visitor  
**Base**



**01**  
chrome



**53**  
soft grey  
powder-coated  
(textured)



**30**  
basic dark  
powder-coated  
(textured)

Landi Chair



**10**  
matte anodised  
aluminium

Lampe de Bureau  
Rayonnage Mural  
Tabouret Métallique  
**Sheet steel**



**88**  
Prouvé Blanc  
Colombe (Ecrû)  
powder-coated  
(smooth)



**06**  
Japanese red  
powder-coated  
(smooth)



**41**  
Prouvé Bleu  
Marcoule powder-  
coated (smooth)



**12**  
deep black  
powder-coated  
(smooth)

Petite Potence  
**Steel tube**

Lounge Chair  
**Base (American cherry, Santos palisander, black-pigmented walnut)**



**03**  
polished  
aluminium



**03/12**  
aluminium polished/deep  
black powder-coated  
(smooth)

**Base (white-pigmented walnut)**



**03**  
polished aluminium

**Base (black ash)**



**12**  
deep black  
powder-coated  
(smooth)

Map Table  
Modesty panel



**52**  
soft light  
powder-coated  
(textured)

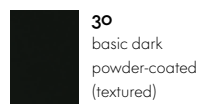

**30**  
basic dark  
powder-coated  
(textured)

Map Table  
Column bases



**01**  
chrome

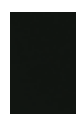

**30**  
basic dark  
powder-coated  
(textured)

Meda Gate  
Base and armrests



**03**  
polished aluminium



**05**  
light silver  
powder-coated  
(smooth)

MedaMorph  
Base



**01**  
chrome



**03**  
polished  
aluminium

MedaSlim  
Base



**01**  
chrome



**03**  
polished  
aluminium



**30**  
basic dark  
powder-coated  
(smooth)

Metal Side Tables  
Table top and base (Outdoor)

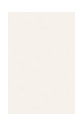

**52**  
soft light  
powder-coated  
(textured)



**23**  
ice grey  
powder-coated  
(textured)



**95**  
galvanised



**21**  
dim grey  
powder-coated  
(textured)



**12**  
deep black  
powder-coated  
(textured)

Table top and base

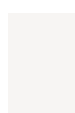

**04**  
white powder-  
coated (smooth)



**40**  
chocolate powder-  
coated (smooth)

NesTable  
Base



**52**  
soft light  
powder-coated  
(textured)



**42**  
warm grey  
powder-coated  
(textured)



**57**  
soft mint  
powder-coated  
(textured)



**23**  
ice grey  
powder-coated  
(textured)



**19**  
sea blue  
powder-coated  
(textured)

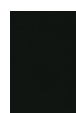

**30**  
basic dark  
powder-coated  
(textured)



**10**  
bright red  
powder-coated  
(textured)

Occasional Low Table  
Base



**40**  
chocolate  
powder-coated  
(textured)

## Physix

## Base



**03**  
polished  
aluminium



**53**  
soft grey  
powder-coated  
(textured)



**12**  
deep black  
powder-coated  
(textured)

## Plate Dining Table

## Plate Table

## Base

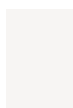

**04**  
white  
powder-coated  
(textured)



**30**  
basic dark  
powder-coated  
(textured)

## Potence

## Tabouret N° 307

## Steel tube



**88**  
Prouvé Blanc  
Colombe (Ecrú)  
powder-coated  
(smooth)



**12**  
deep black  
powder-coated  
(smooth)

## Slow Chair

## Base



**03**  
polished  
aluminium



**40**  
chocolate  
powder-coated  
(smooth)

## Softshell Chair

## Base



**03**  
polished  
aluminium



**30**  
basic dark  
powder-coated  
(smooth)

## Standard

## Standard SP

## Base



**88**  
Prouvé Blanc  
Colombe (Ecrú)  
powder-coated  
(smooth)



**13**  
Prouvé Gris  
Vermeer  
powder-coated  
(smooth)



**18**  
Prouvé Blé Vert  
powder-coated  
(smooth)



**06**  
Japanese red  
powder-coated  
(smooth)



**94**  
Prouvé Métal Brut  
powder-coated  
(transparent,  
smooth)



**41**  
Prouvé Bleu  
Marcoule  
powder-coated  
(smooth)



**14**  
Prouvé Bleu  
Dynastie powder-  
coated (smooth)



**12**  
deep black  
powder-coated  
(smooth)

## Tyde 2

## Base

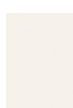

**52**  
soft light  
powder-coated  
(smooth)



**12**  
deep black  
powder-coated  
(smooth)

## Wire Chair

## Seat and base



**01**  
chrome

## Wire Chair

## Seat and base (Outdoor)

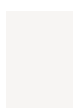

**04**  
white powder-  
coated (smooth)



**30**  
basic dark  
powder-coated  
(smooth)



**92**  
citron powder-  
coated (smooth)

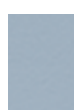

**93**  
sky blue powder-  
coated (smooth)



**31**  
Eames Sea Foam  
Green powder-  
coated (smooth)



**24**  
dark green  
powder-coated  
(smooth)

Wood is characterised by variations in grain, texture and colour, making each wooden furnishing a unique object. Vitra has strict quality standards for the woods selected for its products and uses wood from several trees for the manufacture of a single furniture object made of solid wood. As a result, every piece has a lively and distinctive appearance.

The solid woods used by Vitra are mainly sourced in Europe and have an oiled or lacquered finish, depending on their application. Exposure to light will alter the colour of wood over time.

Chaise Tout Bois  
East River Chair  
HAL Lounge Chair

**Base**

HAL

**Base HAL Wood, Ply Wood, Soft Wood**

Tabouret Haut

**Seat and base**



**10**  
natural oak,  
with protective  
varnish



**04**  
dark stained solid  
oak, with protective  
varnish

Coffee Table

**Base**



**54**  
maple



walnut



**68**  
black ash

Compas Direction  
Eames Segmented Tables Dining  
EM Table  
Occasional Low Table  
Occasional Table LTR

**Table top**



**70**  
natural solid  
oak, oiled



**75**  
solid American  
walnut, oiled



**04**  
dark stained solid  
oak, with protective  
varnish

Fauteuil Direction Pivotant  
Fauteuil de Salon  
Fauteuil Direction

**Armrests**

Guéridon  
Guéridon Bas  
Table S.A.M. Bois

**Table top and legs**

Tabouret Bois

**Seat and base**

Eames Coffee Table  
Table top

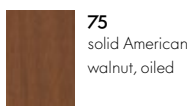

Base

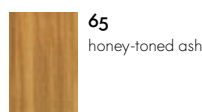
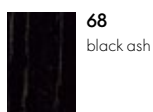

Eames Fiberglass Chairs  
Eames Plastic Chairs  
Base DSW, DAW

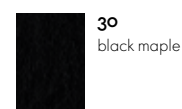
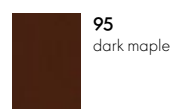
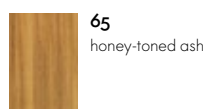
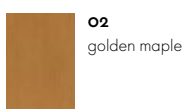

Freeform Sofa  
Legs

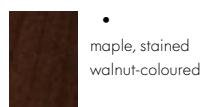
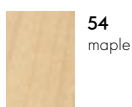

La Chaise  
Base

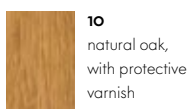

Nelson Bench  
Seat

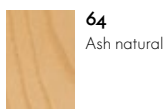

Seating surface & base

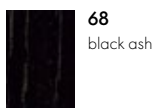

Organic Chair  
Legs

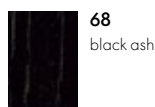
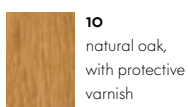
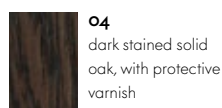
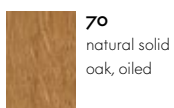
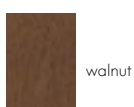

Plate Dining Table  
Plate Table  
Table top  
Rayonnage Mural  
Shelves  
Tabouret N° 307  
Seat



Stools



Wire Chair  
Base

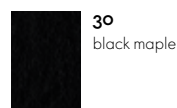
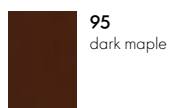
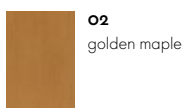

Complex industrial methods are used to produce sheets of wood veneer, which are further processed by hand. In most cases, wood from a single tree is utilised for a piece of furniture to ensure the uniform appearance of all surfaces.

With only two exceptions, Vitra exclusively purchases veneers with a certificate of sustainability from European producers. Vitra's veneers are finished with a protective lacquer; exposure to light will alter the colour over time.

Abalon Table  
 Belleville Table  
 Bistro Table  
 Eames Contract Tables  
 Super Fold Table  
**Table top**

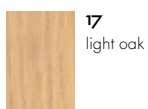

**17**  
light oak

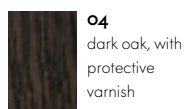

**04**  
dark oak, with protective varnish

AIRLINE  
**Backrest and seat**

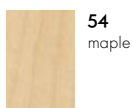

**54**  
maple

Alcove  
 Alcove Plus  
**Table top / Tray**

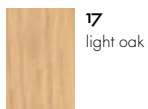

**17**  
light oak

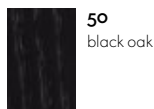

**50**  
black oak

Belleville Chair  
**Seat shell**

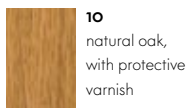

**10**  
natural oak, with protective varnish

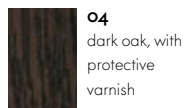

**04**  
dark oak, with protective varnish

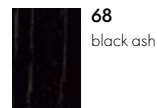

**68**  
black ash

Butterfly Stool

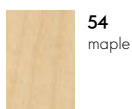

**54**  
maple

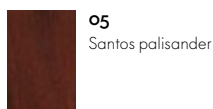

**05**  
Santos palisander

Chaise Tout Bois  
 Moca  
**Backrest and seat**

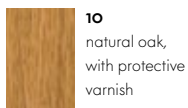

**10**  
natural oak, with protective varnish

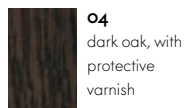

**04**  
dark oak, with protective varnish

EM Table  
**Table top**

HAL  
**Seat shell HAL Ply**



Eames Desk Unit EDU

**Table top**

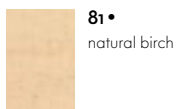

Eames Storage Unit ESU

**Shelf**

Eames Elephant (Plywood)

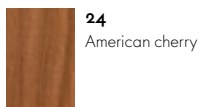

Joyn

Tyde 2

**Table tops**

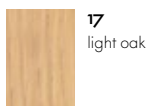

Eames Segmented Tables Meeting

**Table top**

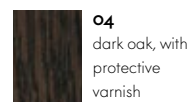
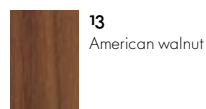
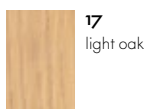

Lounge Chair

**Seat and backrest shell**

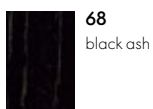
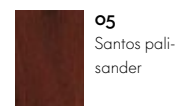
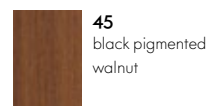
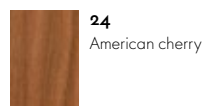

MedaMorph

**Table top**

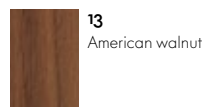
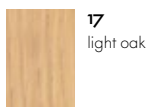

Plywood Group

**Back, seat and base (LCW)**

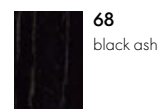
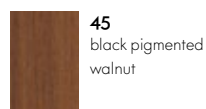
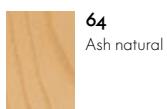

Plywood Group

**Back, seat and base (LCW)**

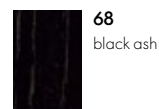
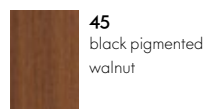
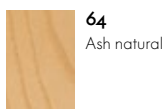

Standard

**Back and seat,**

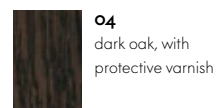
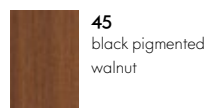

Wooden Side Tables

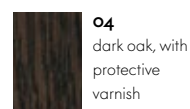
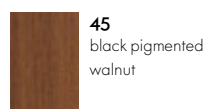
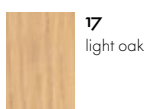

Medium-density fibreboard, also known as MDF board, consists primarily of debarked coniferous wood broken down into fine fibres. MDF is a wood-based material with a uniform structure both lengthwise and crosswise. Its edges are hard and smooth,

making it possible to cut clean profiles. Vitra is an industry leader in the development and application of powder coating methods for MDF. Powder coating produces an even, robust surface finish with seamless edges, making it ideal for constructions with cut-outs or for complex corner joints.

---

Abalon Table

**Table top**

Alcove

Alcove Plus

**Table top / Tray**

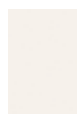

**52**  
soft light  
powder-coated  
(textured)



**30**  
basic dark  
powder-coated  
(textured)

---

Plate Dining Table

Plate Table

**Table top**

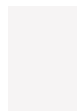

**04**  
white powder-  
coated



**30**  
basic dark  
powder-coated  
(textured)

---

Wood materials with a melamine resin surface coating are robust and durable. They come in a variety of colours, are easy to clean, and provide a less expensive alternative to wood veneer or solid wood.

---

Alcove  
Alcove Plus

**Table top / Tray**

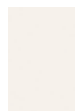

**52**  
soft light

Joyn  
Map Table  
MedaMorph  
Tyde 2

**Table top**

---

Bistro Table  
Belleville Table  
Eames Contract Tables  
Super Fold Table

**Table top**

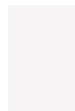

**03•**  
white (textured)

High-pressure laminate, abbreviated as HPL, is composed of layers of paper that are impregnated with phenolic and melamine resins and bonded together with a protective overlay under high pressure and heat, and applied to a substrate. The resulting surfaces are simple to clean and maintain, and they are also lightfast, odorless and resistant to alcohol, organic solvents and water.

Dining Table  
Eames Contract Tables  
Eames Segmented Tables Dining  
Eames Segmented Tables Meeting  
Home Desk  
**Table top**

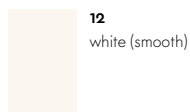

Elliptical Table ETR  
**Table top**

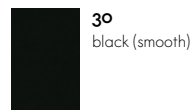

EM Table  
**Table top**

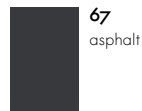
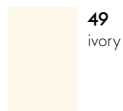

Occasional Table LTR  
**Table top**

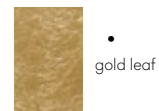
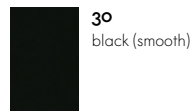
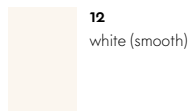

Trapèze  
**Table top**

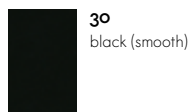

Tyde 2  
**Table top**

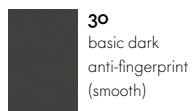

Solid core panels are composed of layers of paper that are impregnated with phenolic and melamine resins and bonded together with a protective overlay under high pressure and heat. The resulting surfaces are simple to clean and maintain, and they are also lightfast, odorless and resistant to alcohol, organic solvents and water. In contrast to HPL on substrate, solid core panels are also suitable for outdoor use.

---

## AIRLINE

**Table unit**



---

Belleville Table  
Bistro Table  
Super Fold Table

**Table tops**

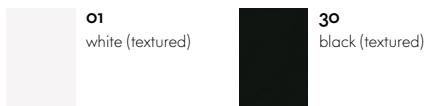

---

Eames Contract Tables

**Table top**

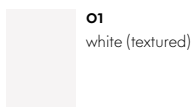

Linoleum is derived from natural and renewable raw materials. This pliant, high-quality substance has a pleasant touch, and fingerprints are almost imperceptible on its surface. It is easy to care for and collects very little dust in comparison to other surface materials, thanks to its anti-static characteristics.

Suita  
**Tray inlay**

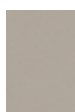

**01**  
pebble



**02**  
charcoal

## Bonded leather

Bonded leather is made up of remnants from Vitra furniture production: leather fibres and offcuts are shredded and bound with vegetable tanning agents, natural rubber, fats and water, then pressed to extract water and dried. Bonded leather allows a judicious use of resources as it is processed from small scraps that would otherwise have no further use. It can be cleaned with a damp cloth.

Bonded leather is available in 5 colours (variants in natural hues with protective sealant; colour variants with coated finish).

Repad  
**Bonded Leather**



**03**  
clay



**04**  
light sage



**05**  
dark red



**06**  
jade



**02**  
natural black

Whenever possible, the marble used by Vitra is a premium quality Carrara marble. Since marble is a natural material, every marble table top has its own unique colour and texture. Vitra treats the marble surfaces with a high-quality sealer to protect them from water, oil, grease and moisture. This sealer penetrates deep into the stone, while still allowing it to breathe.

Unlike the effect of varnish sealing, the stone retains its natural appearance and particularly its colour. Even with this treatment, marble remains a relatively sensitive surface that develops a patina with use.

---

Eames Coffee Table  
Occasional Table LTR  
Plate Dining Table  
Plate Table  
**Table top**



**50**  
marble Carrara

# Glass

Vitra currently uses so-called float glass. This is manufactured by feeding molten glass into a bath of molten tin, where it forms a floating ribbon that then cools. Special heat treatment renders the glass shock and impact resistant (single-pane safety glass according to EN 12150-1).

Painting the underside in a variety of colours, along with a satin surface finish, gives the material a fresh and unusual appearance.

---

Plate Dining Table  
**Table top**



**82**  
white satin finish



**83**  
light grey satin finish

# Cork

Cork, a natural rigid foam harvested from the bark of the cork oak, is distinguished by its light weight and pleasant tactile qualities. The robust, fire-resistant material varies in both colour and texture, so that every piece of furniture or accessory made from cork is a unique, one-of-a-kind object.

---

## Cork Family



• untreated cork

---

# Corrugated Cardboard

Derived from a renewable resource, this natural material is layered and finished with strong side edges to make a small number of Vitra products. In this form, it maintains a surprising degree of stability and rigidity.

---

## Wiggle Side Chair & Wiggle Stool

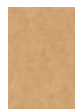

• natural



• natural



# Fleece

The polyester fleece material used by Vitra is thermoformed by the application of heat and pressure and is 100% recyclable. It has a slightly fleecy texture and is somewhat pliable without losing its shape. Polyester fleece has sound-proofing qualities and its relatively fine-pored surface prevents the easy penetration of liquids.

---

Type 2

**Cable tray**



**01**  
pebble grey



**10**  
classic grey

---

# East River Chair

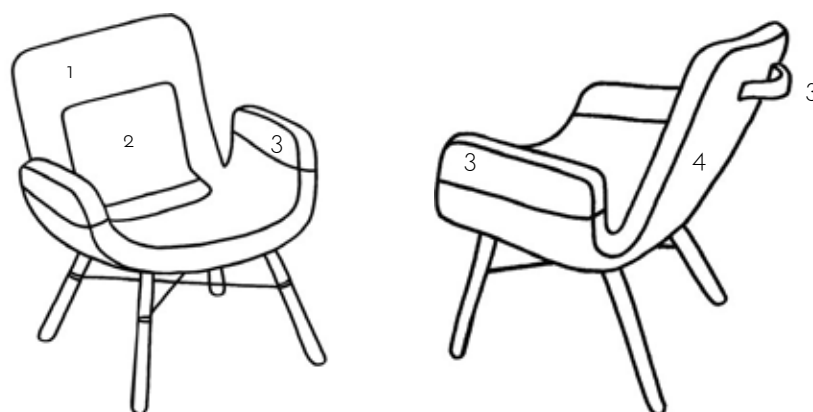

	1	2	3	4
<b>Light mix 01</b>	 <p><b>65</b> Laser RE - ice blue/cream</p>	 <p><b>05</b> Plano - cream white/sierra grey</p>	 <p><b>71</b> Leather Premium F - sand</p>	 <p><b>71</b> Hopsak - yellow/pastel green</p>
<b>Red mix 02</b>	 <p><b>74</b> Laser RE - nude/light red</p>	 <p><b>96</b> Plano - red/cognac</p>	 <p><b>71</b> Leather Premium F - sand</p>	 <p><b>63</b> Hopsak - red/poppy red</p>
<b>Green mix 04</b>	 <p><b>63</b> Laser RE - warm grey/cream</p>	 <p><b>70</b> Hopsak - grass green/forest</p>	 <p><b>67</b> Leather Premium F - asphalt</p>	 <p><b>69</b> Plano - dark grey</p>
<b>Blue mix 05</b>	 <p><b>20</b> Laser RE - ice blue/moor brown</p>	 <p><b>66</b> Plano - nero</p>	 <p><b>67</b> Leather Premium F - asphalt</p>	 <p><b>84</b> Hopsak - blue/moor brown</p>

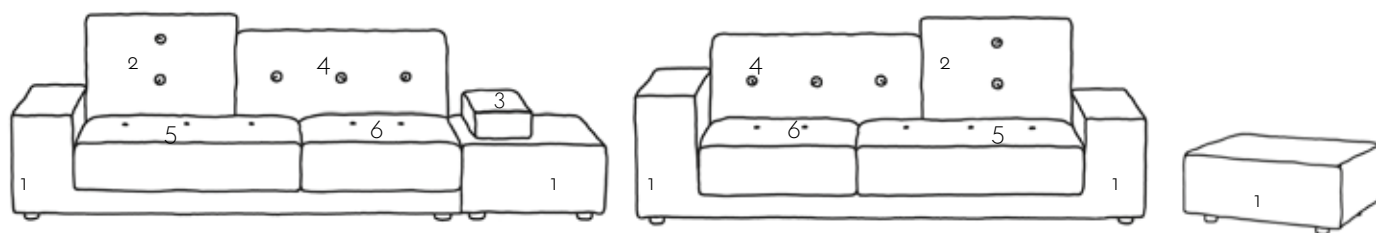

1 2 3 4 5 6

## Fabric mix „The Pebble Greys“

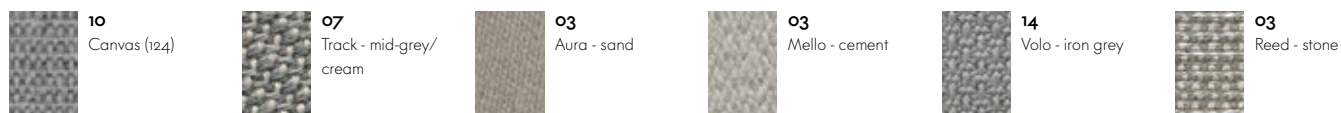

## Fabric mix „The Sea Greens“

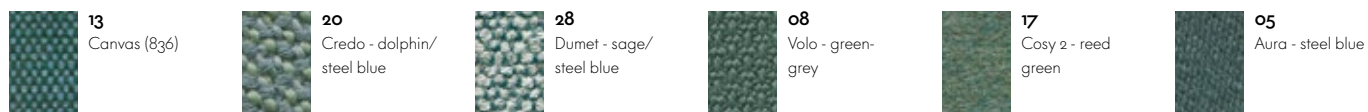

## Fabric mix „The Earth Reds“

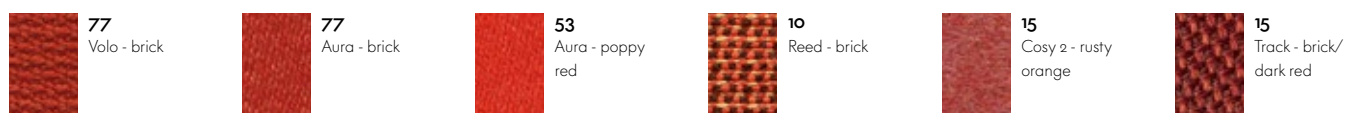

## Fabric mix „The Antarctic Blues“

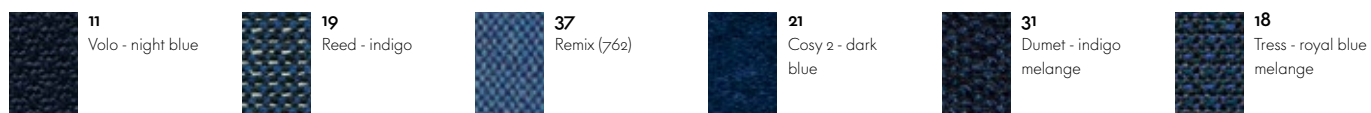

# Slow Chair & Ottoman

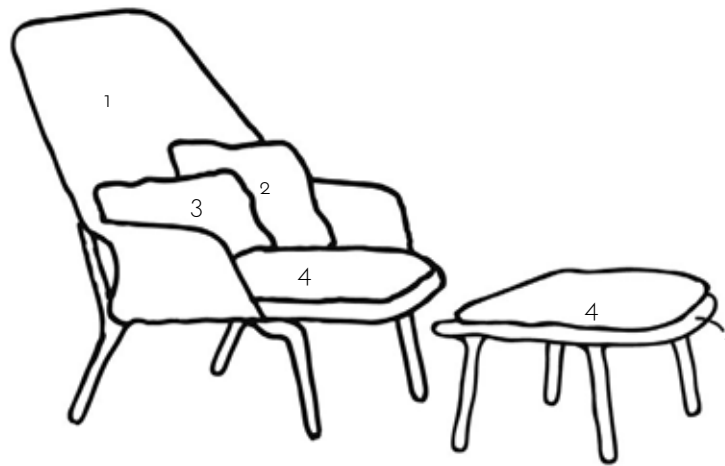

1 Slow Chair & Ottoman      2 Slow Chair      3 Slow Chair      4 Slow Chair & Ottoman

## Slow Chair - red/cream



Tricot - red/cream



Tonus - moss green

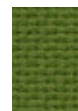

**09**  
Laser - green



Coda - cream

## Slow Chair - brown/cream



Tricot - brown/cream



**03**  
Panamone - moss grey

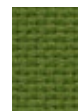

**09**  
Laser - green

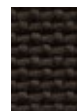

**02**  
Panamone - dark brown

## Slow Chair - brown



Tricot - brown



Intreccio - anthracite



Tonus - moss-green



**13**  
Aura - blackberry

## Slow Chair - black



Tricot - black



Intreccio - anthracite



Tonus - moss-green

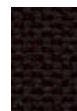

**04**  
Laser - black

## Slow Chair - blue/green



Tricot - blue/green



**77**  
Hopsak - nero/forest



**04**  
Twill - ink blue



**22**  
Laser - dark blue/forest



**vitra.**