

Swedish
—
PRICE LIST
2022/2023

JANUARY 2023



SENAB

Färgmarkeringar och/eller symboler för hållbara alternativ i prislistan:

Mörkgrön markering eller symbol

Miljömärkt produkt – Möbler där hela den sammansatta varan har en typ 1 miljömärkning enligt ISO 14024 med Svanen, Möbelfakta, EU Ecolabel eller annan likvärdig märkning.

Ljusgrön markering eller symbol

Hållbarhetsmärkt produkt eller beståndsdel – Möbler där hela eller delar av den sammansatta varan är hållbarhetsmärkt, exempelvis med FSC, EU Ecolabel eller OEKO-TEX®. Leverantören ska kunna ge mer detaljerad information om vilka delar eller variationer som är hållbarhetsmärka vid begäran.

Orange markering eller symbol

Klimatberäknad produkt – Produkt med dokumenterad miljövarudeklaration (EPD) enligt ISO 14025.

Lila markering eller symbol

Produkt med återvunnet eller förnybart material (enligt definitionerna i ISO 14021). Leverantören ska kunna ge information om andel (%) återvunnet och/eller förnybart (biobaserat) vid begäran. Märkning av återvinningsbart material utgår.

Blå markering eller symbol

Demonterbar produkt – Produkt som är demonterbar till olika komponenter och beståndsdelar som i första hand möjliggör återbruk och i andra hand materialåtervinning när produkten nått sin fulla livslängd. Produkten ska vara designad för renovering, det vill säga att det ska vara enkelt att reparera och byta ut moduler, komponenter och beståndsdelar som slits över tid. Exempelvis ska ytskikt, som bordsskivor, textil och stoppning kunna tas isär, avlägsnas och ersättas med hjälp av vanligt förekommande manuella verktyg, ej specialverktyg. Enklare reparationer och utbytesarbeten ska kunna utföras av en lekman. Om det krävs fackmanakunskap för mer avancerade arbeten ska det framgå av anvisningarna som leverantören ska kunna ge vid begäran. Anvisningarna ska innehålla en sprängskiss, steg för steg beskrivning inklusive vilka verktyg som krävs samt hur möbelns ingående delar bör källsorteras.

Welcome to the Four Design collection

So, what will you find here? In short, high quality, ground-breaking, multipurpose, problem-solving, and comfortable furniture solutions that shape good environments into great experiences. Our products are constructed from only the finest components, and we operate to stringent quality and environmental standards.

Let's Talk

We are always at your service to help you with space planning and the right choice of materials and fabrics. Moreover, all measurements in this pricelist are in millimeters and are approximate and may vary depending on components used, which we reserve the right to change from time to time. Likewise, within the product descriptions, we have specified the standard tabletops and frame options available. If you would like a different specification or would like to find out more about other wood or colour options, please contact us on e-mail: info@fourdesign.dk

www.fourdesign.dk

You are always welcome on our website, where you can find more information and technical info.

FourSure® Family ↗



EU Ecolabel
FourSure®



FourSure® 44



FourSure® 88



FourSure® 90/105



FourSure® 66



FourSure® 77



FourSure® 11



FourSure® 99



FourSure® Audi

FourCast® 2 Family ↗



EU Ecolabel
FourCast® 2



FourCast® 2 Four



FourCast® 2 Line



FourCast® 2 Counter /
High



FourCast® 2 Counter
Four / High Four



FourCast® 2 Wheeler



FourCast® 2 77



FourCast® 2 One



FourCast® 2 Fire
Retardant

FourMe® Family ↗



FourMe® 44



FourMe® 88



FourMe® 66

G2 ↗



G2

Stools & Benches ↗



Four® Stools



Four® Seating
Benches



Casino

FourReal® Table Family ↗



FourReal® 74



FourReal® 90



FourReal® 105



FourReal® 741 Flake



FourReal® A 74 /
A 90



FourReal® A 74 XL /
XL 90

Four® Tables ↗



Four® Learning



Four® Eating



Four® Meeting



Four® Standing
90 / 103



Four® Resting
H 51 / 64 / 72,5 / 103



Harc Tub Table



Y-Table

Soft seating ↗



FourUs®
Family



Harc
Family

Links

[Sustainability ↗](#)

[Certificates ↗](#)

[Electrical accessories ↗](#)

[Accessories ↗](#)

[Colour codes ↗](#)

[Fabric bands ↗](#)

[Terms & Conditions ↗](#)

[Contact ↗](#)



FEATURES

- The chair consists of 50 % recycled plastic
- Limitation of substances that are harmful to health and the environment
- Linking device optional on frames or under seat
- Matches table height 74 cm, 90 cm & 105 cm
- Polyamide glides as standard
- Stackable on matching trolley

For product information visit fourdesign.dk ↗

SHELL COLOURS

Standard Polypropylene









FRAME COLOURS

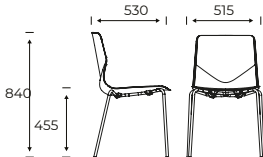

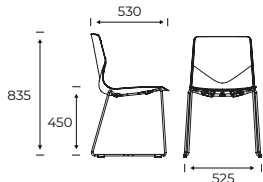

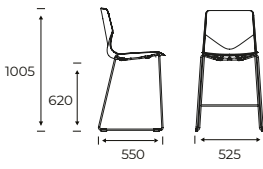

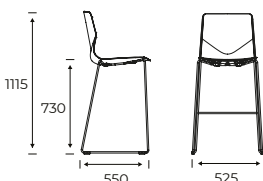

Standard

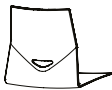

For full colour details [go to page 156](#) ↗

Product	Description (Item nr)	Weight (Kg)	Stacking on floor	Dimensions (mm)	Band	Standard PP (SEK)
	22500 FourSure® 44, Polypropylene shell	5	-		-	2.020
	23200 FourSure® 88, Polypropylene shell	6	-		-	2.479
	23800 FourSure® 90, Polypropylene shell	6.9	-		-	3.409
	23900 FourSure® 105, Polypropylene shell	7.7	-		-	3.492

Design by Strand+Hvass

ACCESSORIES	Description	Weight (Kg)	Dimensions (mm)	Price (SEK)
	CHAIR FEET Felt glides, set of 4 pcs. height + 0,2 cm	1,82 g x 4		208
	CHAIR FEET Teflon glides, set of 4 pcs. Chair height + 0,2 cm	2,75 g x 4		208
	LINKING DEVICE Chair linking	0,4 KG	C/C 535 mm C/C with armrest 585 mm C/C with Loop armrest 625 mm	417
	LINKING DEVICE Chair linking		C/C 540 mm C/C with armrest 540 mm	390
	GRIP HOLE Available for chairs without inside – and full upholstery			189
	SEAT ROW NUMBER - ACSR0201 11 mm - no. 1 -25	29 g		1.579
	SEAT ROW NUMBER - ACSR0202 11 mm - no. 26 -50	29 g		1.579
	SEAT ROW NUMBER - ACSR0101 16 mm - no. 1 -25	29 g		1.579
	SEAT ROW NUMBER - ACSR0102 16 mm - no. 26 -50	29 g		1.579
	CHAIR TROLLEY - 200X0 28 chairs without upholstery	33,5 Kg	1100 x 560 x 1970 mm	8.859



FEATURES

- Armrest options and wooden legs options*
- Linking device under seat options
- Monochrome powder coating on frames options
- Polyamide glides as standard
- Inno® Note tablet options
- Stackable on matching trolley
- Outdoor options
- We do not recommend suspensions for fully upholstered version
- *Round oak oiled nature/stained black legs: Limited stock available

For product information visit fourdesign.dk ↗

SHELL COLOURS

Standard Polypropylene



FRAME COLOURS

Standard



Optional Polypropylene

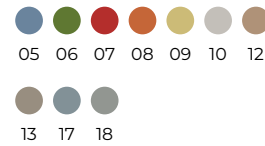

Frame optional*











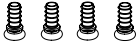

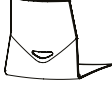

For full colour details [go to page 156](#) ↗

Product	Description (Item nr)	Weight (Kg)	Stacking on floor	Dimensions (mm)	Band	Standard PP (SEK)	Optional PP (SEK)
	22500 FourSure® 44, Polypropylene shell	5	-		-	2.020	2.211
	22510 FourSure® 44, Seat pad	5.9	10		1 2 3 4 5 6 7 8 10	3.282 3.377 3.472 3.566 3.658 3.754 3.849 3.943 4.161	3.473 3.568 3.663 3.757 3.849 3.945 4.040 4.134 4.352
	22520 FourSure® 44, Inside upholstery	6.3	8		1 2 3 4 5 6 7 8 10	4.438 4.629 4.821 5.010 5.202 5.393 5.584 5.774 6.158	4.629 4.820 5.012 5.201 5.393 5.584 5.775 5.965 6.349
	22530 FourSure® 44, Fully upholstered	5.7	6		1 2 3 4 5 6 7 8 10	4.719 4.940 5.161 5.382 5.601 5.824 6.044 6.265 6.748	

Product	Description (Item nr)	Weight (Kg)	Stacking on floor	Dimensions (mm)	Band	Standard PP (SEK)	Optional PP (SEK)
	22600 FourSure® 44 with Armrests, Polypropylene shell	5.6	12		-	3.174	3.365
	22610 FourSure® 44 with Armrests, Seat pad	6.4	10		1 2 3 4 5 6 7 8 10	4.436 4.531 4.626 4.720 4.812 4.908 5.003 5.097 5.315	4.627 4.722 4.817 4.911 5.003 5.099 5.194 5.288 5.506
	22620 FourSure® 44 with Armrests, Inside upholstery	6.8	8		1 2 3 4 5 6 7 8 10	5.592 5.783 5.975 6.164 6.356 6.547 6.738 6.928 7.312	5.783 5.974 6.166 6.355 6.547 6.738 6.929 7.119 7.503
	22630 FourSure® 44 with Armrests, Fully upholstered	6.2	6		1 2 3 4 5 6 7 8 10	5.873 6.094 6.315 6.536 6.755 6.978 7.198 7.419 7.902	
	22700 FourSure® 44 with Loop Armrests, Polypropylene shell	6.1	12		-	3.174	3.365
	22710 FourSure® 44 with Loop Armrests, Seat pad	6.9	10		1 2 3 4 5 6 7 8 10	4.436 4.531 4.626 4.720 4.812 4.908 5.003 5.097 5.315	4.627 4.722 4.817 4.911 5.003 5.099 5.194 5.288 5.506
	22720 FourSure® 44 with Loop Armrests, Inside upholstery	7.3	8		1 2 3 4 5 6 7 8 10	5.592 5.783 5.975 6.164 6.356 6.547 6.738 6.928 7.312	5.783 5.974 6.166 6.355 6.547 6.738 6.929 7.119 7.503
	22730 FourSure® 44 with Loop Armrests, Fully upholstered	6.8	6		1 2 3 4 5 6 7 8 10	5.873 6.094 6.315 6.536 6.755 6.978 7.198 7.419 7.902	

Product	Description (Item nr)	Weight (Kg)	Stacking on floor	Dimensions (mm)	Band	Standard PP (SEK)	Optional PP (SEK)
	22500 FourSure® 44, Polypropylene shell, Oak oil, nature	5	-		-	3.353	3.544
	22510 FourSure® 44, Seat pad, Oak oil, nature	5.9	-		1 2 3 4 5 6 7 8 10	4.615 4.710 4.805 4.899 4.991 5.087 5.182 5.276 5.494	4.806 4.901 4.996 5.090 5.182 5.278 5.373 5.467 5.685
	22520 FourSure® 44, Inside upholstery, Oak oil, nature	6.3	-		1 2 3 4 5 6 7 8 10	5.771 5.962 6.154 6.343 6.535 6.726 6.917 7.108 7.491	5.962 6.153 6.345 6.534 6.726 6.917 7.108 7.298 7.682
	22530 FourSure® 44, Fully upholstered, Oak oil, nature	5.7	-		1 2 3 4 5 6 7 8 10	6.052 6.273 6.494 6.715 6.934 7.157 7.377 7.598 8.081	
	22500 FourSure® 44, Polypropylene shell, Oak lacquered	5	-		-	3.748	3.939
	22510 FourSure® 44, Seat pad, Oak lacquered	5.9	-		1 2 3 4 5 6 7 8 10	5.010 5.105 5.200 5.294 5.386 5.482 5.577 5.671 5.889	5.201 5.296 5.391 5.485 5.577 5.673 5.768 5.862 6.080
	22520 FourSure® 44, Inside upholstery, Oak lacquered	6.3	-		1 2 3 4 5 6 7 8 10	6.166 6.357 6.549 6.738 6.930 7.121 7.312 7.502 7.886	6.357 6.548 6.740 6.929 7.121 7.312 7.503 7.693 8.077
	22530 FourSure® 44, Fully upholstered, Oak lacquered	5.7	-		1 2 3 4 5 6 7 8 10	6.447 6.668 6.889 7.110 7.329 7.552 7.772 7.993 8.476	

ACCESSORIES	Description	Weight (Kg)	Dimensions (mm)	Price (SEK)
	CHAIR FEET Felt glides, set of 4 pcs. height + 0,2 cm	1,82 g x 4		208
	CHAIR FEET Set of 4 pcs. Noise reducing ferrule with big diameter (reduces pressure marks) Chair height + 0,8 cm	4,8 g x 4		276
	CHAIR FEET Noise reducing ferrule with felt, set of 4 pcs. Chair height + 1 cm	6,6 g x 4		276
	CHAIR FEET Teflon glides, set of 4 pcs. Chair height + 0,2 cm	2,75 g x 4		208
	LINKING DEVICE Chair linking	0,4 KG	C/C 535 mm C/C with armrest 585 mm C/C with Loop armrest 625 mm	417
	GRIP HOLE Available for chairs without inside – and full upholstery			189
	INNO Inno® Note in black, removable and foldable. Not available for chairs with Loop armrest and chairs with wooden legs.	1,2 KG	225 x 325 x 20 mm	1.522
	SEAT ROW NUMBER - ACSR0101 16 mm - no. 1 -25	29 g		1.579
	SEAT ROW NUMBER - ACSR0102 16 mm - no. 26 -50	29 g		1.579
	INNO@NOTE TROLLEY - 20100007 Trolley for Inno® Note. Room for 51 Inno® Notes.	58,5 Kg	1532 x 662 x 1199 mm	19.942
	CHAIR TROLLEY - 200X0 28 chairs without upholstery	33,5 Kg	1100 x 560 x 1970 mm	8.859
	CHAIR TROLLEY - 200X0 20 chairs with seat pad / inside upholstery or 18 chairs with full upholstery	33,5 Kg	1100 x 560 x 1910 / 1980 mm	10.373
	SACK TROLLEY - 200X1 12 chairs without upholstery, 10 chairs with seat pad / inside upholstery or 6 chairs with full upholstery			4.918

SURCHARGE		Price (SEK)
	 7 A D E F M N O Q S T	194
FRAME OPTIONAL	 P	473
	 V	476



FEATURES

- Armrest options
- Linking device optional on frames or under seat
- Monochrome powder coating on frames options
- Polyamide glides as standard
- Inno® Note tablet options
- Stackable on matching trolley
- Outdoor options
- We do not recommend suspensions for fully upholstered version

For product information visit fourdesign.dk ↗

SHELL COLOURS

Standard Polypropylene



FRAME COLOURS

Standard



Optional Polypropylene

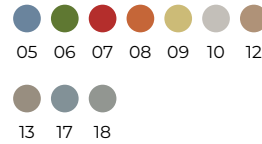









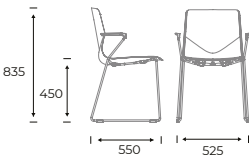

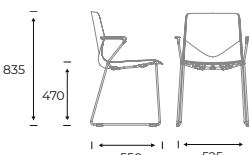

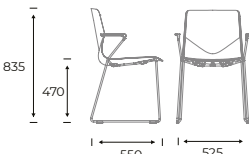

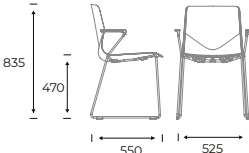

Frame optional*

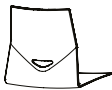

For full colour details [go to page 156](#) ↗

Product	Description (Item nr)	Weight (Kg)	Stacking on floor	Dimensions (mm)	Band	Standard PP (SEK)	Optional PP (SEK)
	23200 FourSure® 88, Polypropylene shell	6	12		-	2.479	2.670
	23210 FourSure® 88, Seat pad	6.8	10		1 2 3 4 5 6 7 8 10	3.741 3.836 3.931 4.025 4.117 4.213 4.308 4.402 4.620	3.932 4.027 4.122 4.216 4.308 4.404 4.499 4.593 4.811
	23220 FourSure® 88, Inside upholstery	7.2	10		1 2 3 4 5 6 7 8 10	4.897 5.088 5.280 5.469 5.661 5.852 6.043 6.233 6.617	5.088 5.279 5.471 5.660 5.852 6.043 6.234 6.424 6.808
	23230 FourSure® 88, Fully upholstered	6.6	8		1 2 3 4 5 6 7 8 10	5.178 5.399 5.620 5.841 6.060 6.283 6.503 6.724 7.207	

Product	Description (Item nr)	Weight (Kg)	Stacking on floor	Dimensions (mm)	Band	Standard PP (SEK)	Optional PP (SEK)
	23300 FourSure® 88 with Armrests, Polypropylene shell	6.7	12		-	3.609	3.800
	23310 FourSure® 88 with Armrests, Seat pad	7.5	10		1 2 3 4 5 6 7 8 10	4.871 4.966 5.061 5.155 5.247 5.343 5.438 5.532 5.750	5.062 5.157 5.252 5.346 5.438 5.534 5.629 5.723 5.941
	23320 FourSure® 88 with Armrests, Inside upholstery	7.9	10		1 2 3 4 5 6 7 8 10	6.027 6.218 6.410 6.599 6.791 6.982 7.173 7.363 7.747	6.218 6.409 6.601 6.790 6.982 7.173 7.364 7.554 7.938
	23330 FourSure® 88 with Armrests, Fully upholstered	7.4	8		1 2 3 4 5 6 7 8 10	6.308 6.529 6.750 6.971 7.190 7.413 7.633 7.854 8.337	

ACCESSORIES	Description	Weight (Kg)	Dimensions (mm)	Price (SEK)
	CHAIR FEET Felt glides, set of 4 pcs. height + 0,2 cm	1,82 g x 4		208
	CHAIR FEET Teflon glides, set of 4 pcs. Chair height + 0,2 cm	2,75 g x 4		208
	LINKING DEVICE Chair linking	0,4 KG	C/C 535 mm C/C with armrest 585 mm C/C with Loop armrest 625 mm	417
	LINKING DEVICE Chair linking		C/C 540 mm C/C with armrest 540 mm	390
	GRIP HOLE Available for chairs without inside – and full upholstery			189
	INNO Inno® Note in black, removable and foldable. Not available for chairs with Loop armrest and chairs with wooden legs.	1,2 KG	225 x 325 x 20 mm	1.522
	SEAT ROW NUMBER - ACSR0201 11 mm - no. 1 -25	29 g		1.579
	SEAT ROW NUMBER - ACSR0202 11 mm - no. 26 -50	29 g		1.579
	INNO@NOTE TROLLEY - 20100007 Trolley for Inno® Note. Room for 51 Inno® Notes.	58,5 Kg	1532 x 662 x 1199 mm	19.942
	CHAIR TROLLEY - 200X0 35 chairs without upholstery	33,5 Kg	1100 x 560 x 1970 mm	8.859
	CHAIR TROLLEY - 200X0 20 chairs with seat pad / inside upholstery or 18 chairs with full upholstery	33,5 Kg	1100 x 560 x 1910 / 1980 mm	10.373
	SACK TROLLEY - 200X1 12 chairs without upholstery, 10 with seat pad / inside upholstery or 8 chairs with full upholstery			4.918
SURCHARGE				Price (SEK)
FRAME OPTIONAL	 7 A D E F M N O Q S T			194



FEATURES

- Fits table height 90 cm
- Stackable on floor
- Polyamide glides as standard
- Monochrome powder coating on frames options
- Outdoor options
- We do not recommend suspensions to fully upholstered version

For product information visit fourdesign.dk ↗

SHELL COLOURS

Standard Polypropylene



FRAME COLOURS

Standard



Optional Polypropylene

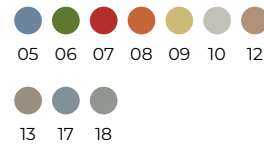







Frame optional*

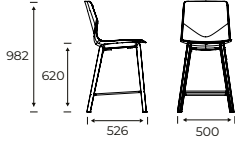

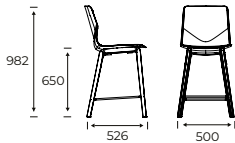
For full colour details [go to page 156](#) ↗

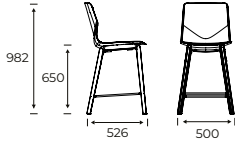
Product	Description (Item nr)	Weight (Kg)	Stacking on floor	Dimensions (mm)	Band	Standard PP (SEK)	Optional PP (SEK)
	23800 FourSure® 90, Polypropylene shell	6.9	4		-	3.409	3.600
	23810 FourSure® 90, Seat pad	7.8	4		1 2 3 4 5 6 7 8 10	4.671 4.766 4.861 4.955 5.047 5.143 5.238 5.332 5.550	4.862 4.957 5.052 5.146 5.238 5.334 5.429 5.523 5.741
	23820 FourSure® 90, Inside upholstery	8.1	4		1 2 3 4 5 6 7 8 10	5.827 6.018 6.210 6.399 6.591 6.782 6.973 7.163 7.547	6.018 6.209 6.401 6.590 6.782 6.973 7.164 7.354 7.738
	23830 FourSure® 90, Fully upholstered	7.6	4		1 2 3 4 5 6 7 8 10	6.108 6.329 6.550 6.771 6.990 7.213 7.433 7.654 8.137	

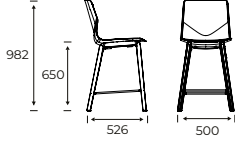
Product	Description (Item nr)	Weight (Kg)	Stacking on floor	Dimensions (mm)	Band	Standard PP (SEK)	Optional PP (SEK)
	23800 FourSure® 90, Polypropylene shell, Oak lacquered	6.9	-		-	5.170	5.361
	23810 FourSure® 90, Seat pad, Oak lacquered	7.8	-		1 2 3 4 5 6 7 8 10	6.432 6.527 6.622 6.716 6.808 6.904 6.999 7.093 7.311	6.623 6.718 6.813 6.907 6.999 7.095 7.190 7.284 7.502
	23820 FourSure® 90, Inside upholstery, Oak lacquered	8.1	-		1 2 3 4 5 6 7 8 10	7.588 7.779 7.971 8.160 8.352 8.543 8.734 8.924 9.308	7.779 7.970 8.162 8.351 8.543 8.734 8.925 9.115 9.499
	23830 FourSure® 90, Fully upholstered, Oak lacquered	7.6	-		1 2 3 4 5 6 7 8 10	7.869 8.090 8.311 8.532 8.751 8.974 9.194 9.415 9.898	

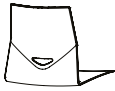
ACCESSORIES	Description	Weight (Kg)	Dimensions (mm)	Price (SEK)
	CHAIR FEET Felt glides, set of 4 pcs. height + 0,2 cm	1,82 g x 4		208
	CHAIR FEET Teflon glides, set of 4 pcs. Chair height + 0,2 cm	2,75 g x 4		208
	GRIP HOLE Available for chairs without inside – and full upholstery			189

SURCHARGE		Price (SEK)
FRAME OPTIONAL	 7 A D E F M N O Q S T  V	194 475



FEATURES

- Fits table height 105 cm
- Stackable on floor
- Polyamide glides as standard
- Monochrome powder coating on frames options
- Outdoor options
- We do not recommend suspensions to fully upholstered version

For product information visit fourdesign.dk ↗

SHELL COLOURS

Standard Polypropylene



FRAME COLOURS

Standard



Optional Polypropylene

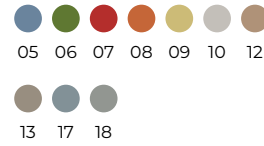







Frame optional*

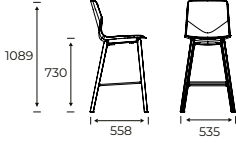

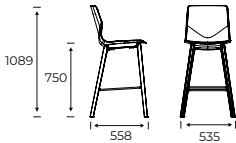
For full colour details [go to page 156](#) ↗

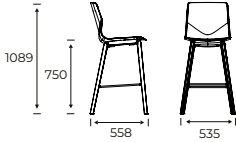
Product	Description (Item nr)	Weight (Kg)	Stacking on floor	Dimensions (mm)	Band	Standard PP (SEK)	Optional PP (SEK)
	23900 FourSure® 105, Polypropylene shell	7.7	4		-	3.492	3.683
	23910 FourSure® 105, Seat pad	8.5	4		1 2 3 4 5 6 7 8 10	4.754 4.849 4.944 5.038 5.130 5.226 5.321 5.415 5.633	4.945 5.040 5.135 5.229 5.321 5.417 5.512 5.606 5.824
	23920 FourSure® 105, Inside upholstery	8.9	4		1 2 3 4 5 6 7 8 10	5.910 6.101 6.293 6.482 6.674 6.865 7.056 7.246 7.630	6.101 6.292 6.484 6.673 6.865 7.056 7.247 7.437 7.821
	23930 FourSure® 105, Fully upholstered	8.4	4		1 2 3 4 5 6 7 8 10	6.191 6.412 6.633 6.854 7.073 7.296 7.516 7.737 8.220	

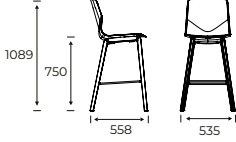
Product	Description (Item nr)	Weight (Kg)	Stacking on floor	Dimensions (mm)	Band	Standard PP (SEK)	Optional PP (SEK)
	23900 FourSure® 105, Polypropylene shell, Oak lacquered	7.7	-		-	5.366	5.557
	23910 FourSure® 105, Seat pad, Oak lacquered	8.5	-		1 2 3 4 5 6 7 8 10	6.628 6.723 6.818 6.912 7.004 7.100 7.195 7.289 7.507	6.819 6.914 7.009 7.103 7.195 7.291 7.386 7.480 7.698
	23920 FourSure® 105, Inside upholstery, Oak lacquered	8.9	-		1 2 3 4 5 6 7 8 10	7.784 7.975 8.167 8.356 8.548 8.739 8.930 9.120 9.504	7.975 8.166 8.358 8.547 8.739 8.930 9.121 9.311 9.695
	23930 FourSure® 105, Fully upholstered, Oak lacquered	8.4	-		1 2 3 4 5 6 7 8 10	8.065 8.286 8.507 8.728 8.947 9.170 9.390 9.611 10.094	

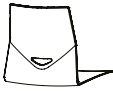
ACCESSORIES	Description	Weight (Kg)	Dimensions (mm)	Price (SEK)
	CHAIR FEET Felt glides, set of 4 pcs. height + 0,2 cm	1,82 g x 4		208
	CHAIR FEET Teflon glides, set of 4 pcs. Chair height + 0,2 cm	2,75 g x 4		208
	GRIP HOLE Available for chairs without inside – and full upholstery			189

SURCHARGE		Price (SEK)
FRAME OPTIONAL	 7 A D E F M N O Q S T  V	194 474



FEATURES

- Inno® Tab, flexible and rotating writing tablet options
- Gas lift, 41 - 57,5 cm
- Free Float options
- Black base with castors as standard
- Aluminium base options
- We do not recommend suspensions to fully upholstered version

For product information visit fourdesign.dk ↗

SHELL COLOURS

Standard Polypropylene



FRAME COLOURS

Standard



Optional Polypropylene

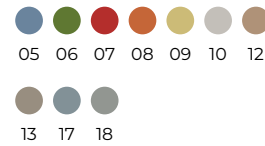









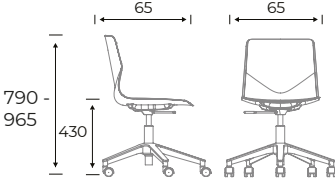

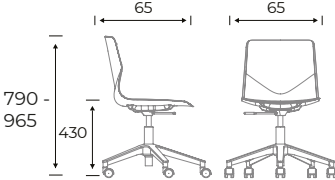

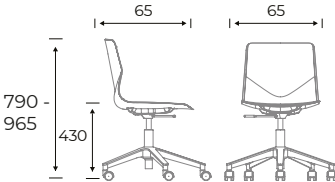

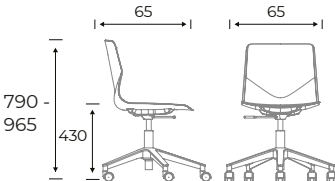

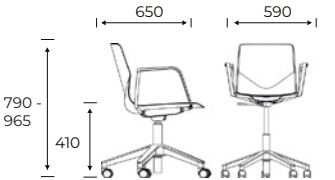

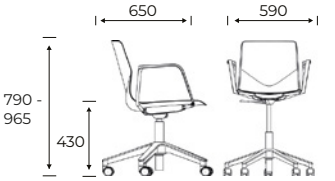

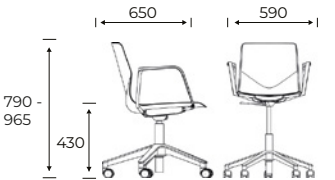
Frame optional*

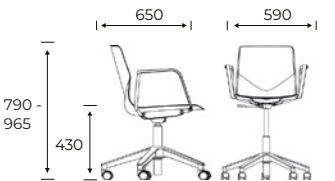

For full colour details [go to page 156](#) ↗

Product	Description (Item nr)	Weight (Kg)	Dimensions (mm)	Band	Standard PP (SEK)	Optional PP (SEK)
	25004 FourSure® 66, Polypropylene shell, Without tilt with gas	7.4		-	2.783	2.974
	25005 FourSure® 66, Polypropylene shell, With tilt with gas	7.5		-	3.147	3.338
	25014 FourSure® 66, Seat pad, Without tilt with gas	8		1 2 3 4 5 6 7 8 10	4.045 4.140 4.235 4.329 4.421 4.517 4.612 4.706 4.924	4.236 4.331 4.426 4.520 4.612 4.708 4.803 4.897 5.115
	25015 FourSure® 66, Seat pad, With tilt with gas	8		1 2 3 4 5 6 7 8 10	4.409 4.504 4.599 4.693 4.785 4.881 4.976 5.070 5.288	4.600 4.695 4.790 4.884 4.976 5.072 5.167 5.261 5.479

Product	Description (Item nr)	Weight (Kg)	Dimensions (mm)	Band	Standard PP (SEK)	Optional PP (SEK)
	25024 FourSure® 66, Inside upholstery, Without tilt with gas	8.4		1 2 3 4 5 6 7 8 10	5.201 5.392 5.584 5.773 5.965 6.156 6.347 6.537 6.921	5.392 5.583 5.775 5.964 6.156 6.347 6.538 6.728 7.112
	25025 FourSure® 66, Inside upholstery, With tilt with gas	8.4		1 2 3 4 5 6 7 8 10	5.565 5.756 5.948 6.137 6.329 6.520 6.711 6.901 7.285	5.756 5.947 6.139 6.328 6.520 6.711 7.092 7.476
	25034 FourSure® 66, Fully upholstered, Without tilt with gas	7.8		1 2 3 4 5 6 7 8 10	5.482 5.703 5.924 6.145 6.364 6.587 6.807 7.028 7.511	
	25035 FourSure® 66, Fully upholstered, With tilt with gas	13.7		1 2 3 4 5 6 7 8 10	5.846 6.067 6.288 6.509 6.728 6.951 7.171 7.392 7.875	
	24905 FourSure® 66 with Loop Armrests, Polypropylene shell, With tilt with gas	8.7		-	4.291	4.482
	24915 FourSure® 66 with Loop Armrests, Seat pad, With tilt with gas	9.4		1 2 3 4 5 6 7 8 10	5.553 5.648 5.743 5.837 5.929 6.025 6.120 6.214 6.432	5.744 5.839 5.934 6.028 6.120 6.216 6.311 6.405 6.623
	24925 FourSure® 66 with Loop Armrests, Inside upholstery, With tilt with gas	9.7		1 2 3 4 5 6 7 8 10	6.709 6.900 7.092 7.281 7.473 7.664 7.855 8.045 8.429	6.900 7.091 7.283 7.472 7.664 7.855 8.046 8.236 8.620
	24935 FourSure® 66 with Loop Armrests, Fully upholstered, With tilt with gas	9.2		1 2 3 4 5 6 7 8 10	6.990 7.211 7.432 7.653 7.872 8.095 8.315 8.536 9.019	

ACCESSORIES	Description	Weight (Kg)	Dimensions (mm)	Price (SEK)
	HOOK Hook in black			47
	CHAIR FEET Standard polymide glides. Chair height + 0,2 cm			
	FOOTRING Gas lift including footring Spand 41 cm. - 57,5 cm.		585 - 845 mm	1.368
	With GS certification			1.489
	INNO Foldable Inno® Tab in black with integrated cup holder and dashboard for tablet and phone.	2,7 KG	520 x 320 x 230 mm	2.125
SURCHARGE				Price (SEK)
FRAME OPTIONAL	 4			643



FEATURES

- Armrest options
- Stackable on floor
- Monochrome powder coating on frames options
- We do not recommend suspensions for fully upholstered version

For product information visit fourdesign.dk ↗

SHELL COLOURS

Standard Polypropylene



Optional Polypropylene

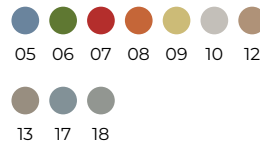

FRAME COLOURS

Standard

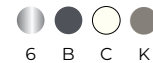







Frame optional*

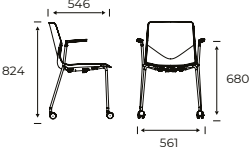

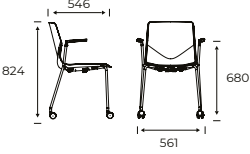
For full colour details [go to page 156](#) ↗

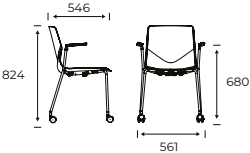
Product	Description (Item nr)	Weight (Kg)	Stacking on floor	Dimensions (mm)	Band	Standard PP (SEK)	Optional PP (SEK)
	22800 FourSure® 77, Polypropylene shell	6	7		-	2.464	2.655
	22810 FourSure® 77, Seat pad	6.9	5		1 2 3 4 5 6 7 8 10	3.726 3.821 3.916 4.010 4.102 4.198 4.293 4.387 4.605	3.917 4.012 4.107 4.201 4.293 4.389 4.484 4.578 4.796
	22820 FourSure® 77, Inside upholstery	7.3	5		1 2 3 4 5 6 7 8 10	4.882 5.073 5.265 5.454 5.646 5.837 6.028 6.218 6.602	5.073 5.264 5.456 5.645 5.837 6.028 6.219 6.409 6.793
	22830 FourSure® 77, Fully upholstered	6.8	5		1 2 3 4 5 6 7 8 10	5.163 5.384 5.605 5.826 6.045 6.268 6.488 6.709 7.192	

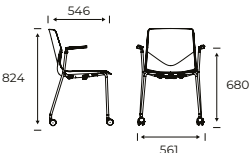
Product	Description (Item nr)	Weight (Kg)	Stacking on floor	Dimensions (mm)	Band	Standard PP (SEK)	Optional PP (SEK)
	22900 FourSure® 77 with Armrests, Polypropylene shell	7.5	-		-	3.618	3.809
	22910 FourSure® 77 with Armrests, Seat pad	8	-		1 2 3 4 5 6 7 8 10	4.880 4.975 5.070 5.164 5.256 5.352 5.447 5.541 5.759	5.071 5.166 5.261 5.355 5.447 5.543 5.638 5.732 5.950
	22920 FourSure® 77 with Armrests, Inside upholstery	8.4	-		1 2 3 4 5 6 7 8 10	6.036 6.227 6.419 6.608 6.800 6.991 7.182 7.372 7.756	6.227 6.418 6.610 6.799 6.991 7.182 7.373 7.563 7.947
	22930 FourSure® 77 with Armrests, Fully upholstered	8.2	-		1 2 3 4 5 6 7 8 10	6.317 6.538 6.759 6.980 7.199 7.422 7.642 7.863 8.346	

ACCESSORIES	Description	Weight (Kg)	Dimensions (mm)	Price (SEK)
	GRIP HOLE Available for chairs without inside – and full upholstery			189

SURCHARGE	Price (SEK)
FRAME OPTIONAL 	194



FEATURES

- Armrest options
- Swivel with freefloat in seat/back
- Return mechanism options
- Polyamide glides as standard
- Teflon or felt glides and soft castor options
- Soft castor options (fixed cone without swivel and return)
- We do not recommend suspensions to fully upholstered version

For product information visit fourdesign.dk ↗

SHELL COLOURS

Standard Polypropylene



FRAME COLOURS





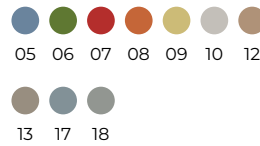

Standard



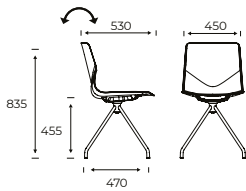

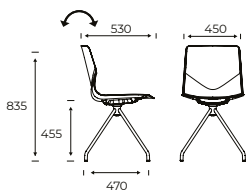

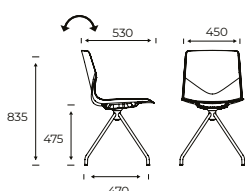

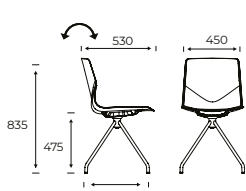

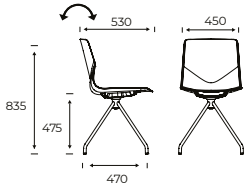

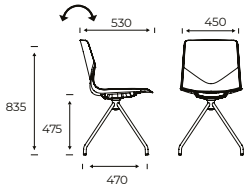

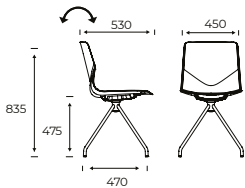

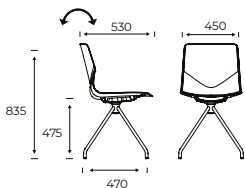

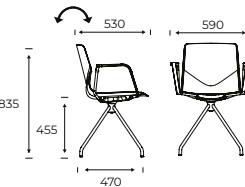

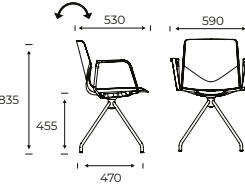

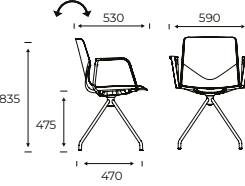

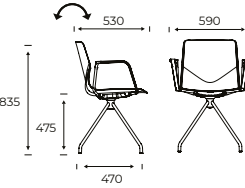
Optional Polypropylene



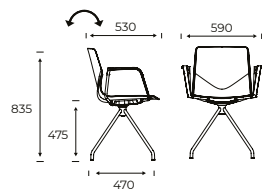

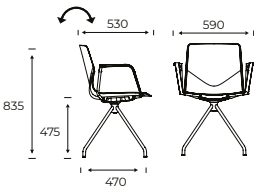
For full colour details [go to page 156](#) ↗

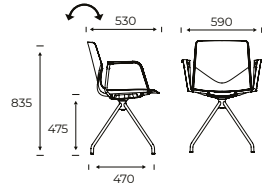
Product	Description (Item nr)	Weight (Kg)	Dimensions (mm)	Band	Standard PP (SEK)	Optional PP (SEK)
	23001 FourSure® 11, Polypropylene shell, With tilt	6.7		-	3.627	3.818
	23003 FourSure® 11, Polypropylene shell, With tilt with return	6.6		-	4.800	4.991
	23011 FourSure® 11, Seat pad, With tilt	7.1		1 2 3 4 5 6 7 8 10	4.889 4.984 5.079 5.173 5.265 5.361 5.456 5.550 5.768	5.080 5.175 5.270 5.364 5.456 5.552 5.647 5.741 5.959
	23013 FourSure® 11, Seat pad, With tilt with return	7.1		1 2 3 4 5 6 7 8 10	6.062 6.157 6.252 6.346 6.438 6.534 6.629 6.723 6.941	6.253 6.348 6.443 6.537 6.629 6.725 6.820 6.914 7.132

Product	Description (Item nr)	Weight (Kg)	Dimensions (mm)	Band	Standard PP (SEK)	Optional PP (SEK)
	23021 FourSure® 11, Inside upholstery, With tilt	7.5		1 2 3 4 5 6 7 8 10	6.045 6.236 6.428 6.617 6.809 7.000 7.191 7.381 7.765	6.236 6.427 6.619 6.808 7.000 7.191 7.382 7.572 7.956
	23023 FourSure® 11, Inside upholstery, With tilt with return	7.4		1 2 3 4 5 6 7 8 10	7.218 7.409 7.601 7.790 7.982 8.173 8.364 8.554 8.938	7.409 7.600 7.792 7.981 8.173 8.364 8.555 8.745 9.129
	23031 FourSure® 11, Fully upholstered, With tilt	7		1 2 3 4 5 6 7 8 10	6.326 6.547 6.768 6.989 7.208 7.431 7.651 7.872 8.355	
	23033 FourSure® 11, Fully upholstered, With tilt with return	6.9		1 2 3 4 5 6 7 8 10	7.499 7.720 7.941 8.162 8.381 8.604 8.824 9.045 9.528	
	23101 FourSure® 11 with Loop Armrests, Polypropylene shell, With tilt	7.8		-	4.780	4.971
	23103 FourSure® 11 with Loop Armrests, Polypropylene shell, With tilt with return	7.7		-	5.953	6.144
	23111 FourSure® 11 with Loop Armrests, Seat pad, With tilt	8.3		1 2 3 4 5 6 7 8 10	6.042 6.137 6.232 6.326 6.418 6.514 6.609 6.703 6.921	6.233 6.328 6.423 6.517 6.609 6.705 6.800 6.894 7.112
	23113 FourSure® 11 with Loop Armrests, Seat pad, With tilt with return	8.2		1 2 3 4 5 6 7 8 10	7.215 7.310 7.405 7.499 7.591 7.687 7.782 7.876 8.094	7.406 7.501 7.596 7.690 7.782 7.878 7.973 8.067 8.285

Product	Description (Item nr)	Weight (Kg)	Dimensions (mm)	Band	Standard PP (SEK)	Optional PP (SEK)
	23121 FourSure® 11 with Loop Armrests, Inside upholstery, With tilt	8.7		1 2 3 4 5 6 7 8 10	7.198 7.389 7.581 7.770 7.962 8.153 8.344 8.534 8.918	7.389 7.580 7.772 7.961 8.153 8.344 8.535 8.725 9.109
	23123 FourSure® 11 with Loop Armrests, Inside upholstery, With tilt with return	8.6		1 2 3 4 5 6 7 8 10	8.371 8.562 8.754 8.943 9.135 9.326 9.517 9.707 10.091	8.562 8.753 8.945 9.134 9.326 9.517 9.708 9.898 10.282
	23131 FourSure® 11 with Loop Armrests, Fully upholstered, With tilt	7.9		1 2 3 4 5 6 7 8 10	7.479 7.700 7.921 8.142 8.361 8.584 8.804 9.025 9.508	
	23133 FourSure® 11 with Loop Armrests, Fully upholstered, With tilt with return	8.1		1 2 3 4 5 6 7 8 10	8.652 8.873 9.094 9.315 9.534 9.757 9.977 10.198 10.681	

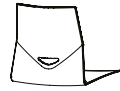
ACCESSORIES	Description	Weight (Kg)	Dimensions (mm)	Price (SEK)
	CHAIR FEET Castors			876
	CHAIR FEET Felt glides, set of 4 pcs. height + 0,2 cm	1,82 g x 4		208
	CHAIR FEET Set of 4 pcs. Noise reducing ferrule with big diameter (reduces pressure marks) Chair height + 0,8 cm	4,8 g x 4		276
	CHAIR FEET Noise reducing ferrule with felt, set of 4 pcs. Chair height + 1 cm	6,6 g x 4		276
	CHAIR FEET Teflon glides, set of 4 pcs. Chair height + 0,2 cm	2,75 g x 4		208
	GRIP HOLE Available for chairs without inside – and full upholstery			189



FEATURES

- Swivel frame with free float seat/back as standard
- Return mechanism options
- Loop Armchair options
- Polyamide glides as standard
- Teflon or felt glides and soft castor options
- Powder coated frame options
- We do not recommend suspensions to fully upholstered version

For product information visit fourdesign.dk ↗

SHELL COLOURS

Standard Polypropylene



FRAME COLOURS

Standard



Optional Polypropylene

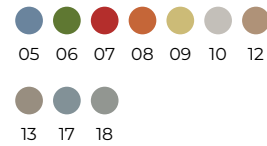









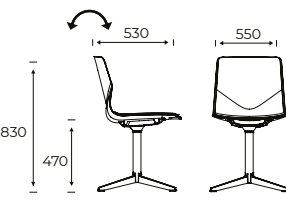

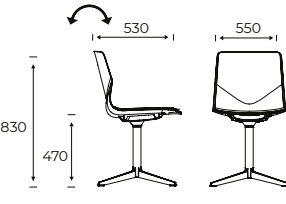

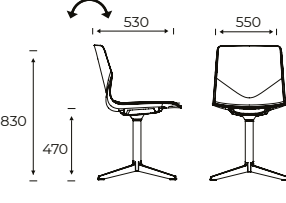

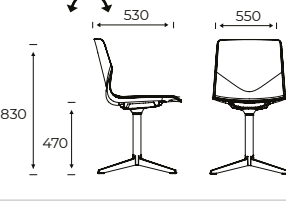



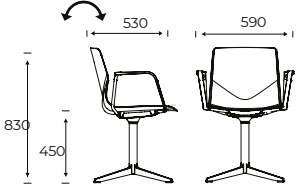

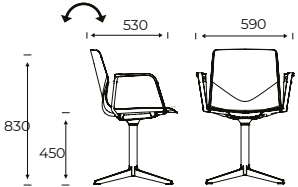

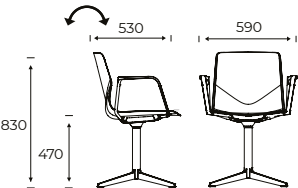
Frame optional*

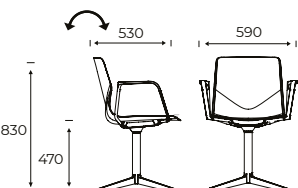

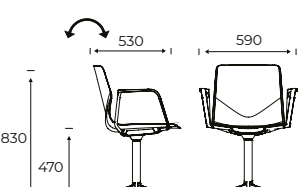

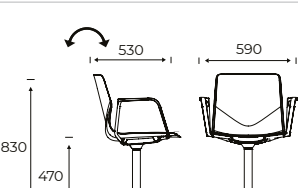

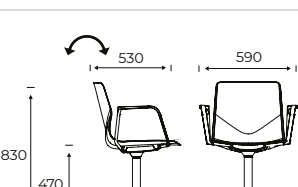

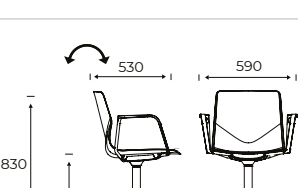
For full colour details [go to page 156](#) ↗

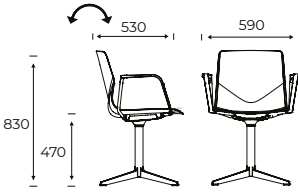
Product	Description (Item nr)	Weight (Kg)	Dimensions (mm)	Band	Standard PP (SEK)	Optional PP (SEK)
	24001 FourSure® 99, Polypropylene shell, With tilt	7.2		-	5.825	6.016
	24003 FourSure® 99, Polypropylene shell, With tilt with return	7.2		-	6.325	6.516
	24005 FourSure® 99, Polypropylene shell, With tilt with gas	7.7		-	6.325	6.516
	24011 FourSure® 99, Seat pad, With tilt	7.7		1 2 3 4 5 6 7 8 10	7.087 7.182 7.277 7.371 7.463 7.559 7.654 7.748 7.966	7.278 7.373 7.468 7.562 7.654 7.750 7.845 7.939 8.157

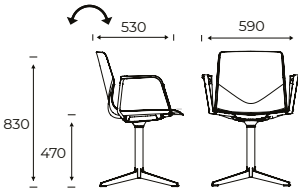
Product	Description (Item nr)	Weight (Kg)	Dimensions (mm)	Band	Standard PP (SEK)	Optional PP (SEK)
	24013 FourSure® 99, Seat pad, With tilt with return	7.7		1	7.587	7.778
				2	7.682	7.873
				3	7.777	7.968
				4	7.871	8.062
				5	7.963	8.154
				6	8.059	8.250
				7	8.154	8.345
				8	8.248	8.439
				10	8.466	8.657
					24015 FourSure® 99, Seat pad, With tilt with gas	8.6
2	7.682	7.873				
3	7.777	7.968				
4	7.871	8.062				
5	7.963	8.154				
6	8.059	8.250				
7	8.154	8.345				
8	8.248	8.439				
10	8.466	8.657				
	24021 FourSure® 99, Inside upholstery, With tilt	8.1				
				2	8.434	8.625
				3	8.626	8.817
				4	8.815	9.006
				5	9.007	9.198
				6	9.198	9.389
				7	9.389	9.580
				8	9.579	9.770
				10	9.963	10.154
					24023 FourSure® 99, Inside upholstery, With tilt with return	8.1
2	8.934	9.125				
3	9.126	9.317				
4	9.315	9.506				
5	9.507	9.698				
6	9.698	9.889				
7	9.889	10.080				
8	10.079	10.270				
10	10.463	10.654				
	24025 FourSure® 99, Inside upholstery, With tilt with gas	9				
				2	8.934	9.125
				3	9.126	9.317
				4	9.315	9.506
				5	9.507	9.698
				6	9.698	9.889
				7	9.889	10.080
				8	10.079	10.270
				10	10.463	10.654
					24031 FourSure® 99, Fully upholstered, With tilt	7.5
2	8.745					
3	8.966					
4	9.187					
5	9.406					
6	9.629					
7	9.849					
8	10.070					
10	10.553					
	24033 FourSure® 99, Fully upholstered, With tilt with return	7.5				
				2	9.245	
				3	9.466	
				4	9.687	
				5	9.906	
				6	10.129	
				7	10.349	
				8	10.570	
				10	11.053	
					24035 FourSure® 99, Fully upholstered, With tilt with gas	-
2	9.245					
3	9.466					
4	9.687					
5	9.906					
6	10.129					
7	10.349					
8	10.570					
10	11.053					

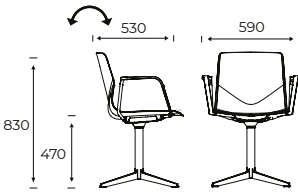
Product	Description (Item nr)	Weight (Kg)	Dimensions (mm)	Band	Standard PP (SEK)	Optional PP (SEK)
	24101 FourSure® 99 with Loop Armrests, Polypropylene shell, With tilt	8.5		-	6.976	7.167
	24103 FourSure® 99 with Loop Armrests, Polypropylene shell, With tilt with return	8.5		-	7.476	7.667
	24105 FourSure® 99 with Loop Armrests, Polypropylene shell, With tilt with gas	9.5		-	7.476	7.667
	24111 FourSure® 99 with Loop Armrests, Seat pad, With tilt	9.1		1 2 3 4 5 6 7 8 10	8.238 8.333 8.428 8.522 8.614 8.710 8.805 8.899 9.117	8.429 8.524 8.619 8.713 8.805 8.901 8.996 9.090 9.308
	24113 FourSure® 99 with Loop Armrests, Seat pad, With tilt with return	9		1 2 3 4 5 6 7 8 10	8.738 8.833 8.928 9.022 9.114 9.210 9.305 9.399 9.617	8.929 9.024 9.119 9.213 9.305 9.401 9.496 9.590 9.808
	24115 FourSure® 99 with Loop Armrests, Seat pad, With tilt with gas	10		1 2 3 4 5 6 7 8 10	8.738 8.833 8.928 9.022 9.114 9.210 9.305 9.399 9.617	8.929 9.024 9.119 9.213 9.305 9.401 9.496 9.590 9.808
	24121 FourSure® 99 with Loop Armrests, Inside upholstery, With tilt	9.4		1 2 3 4 5 6 7 8 10	9.394 9.585 9.777 9.966 10.158 10.349 10.540 10.730 11.114	9.585 9.776 9.968 10.157 10.349 10.540 10.731 10.921 11.305
	24123 FourSure® 99 with Loop Armrests, Inside upholstery, With tilt with return	9.4		1 2 3 4 5 6 7 8 10	9.894 10.085 10.277 10.466 10.658 10.849 11.040 11.230 11.614	10.085 10.276 10.468 10.657 10.849 11.040 11.231 11.421 11.805

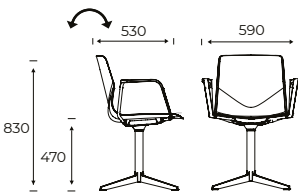
Product	Description (Item nr)	Weight (Kg)	Dimensions (mm)	Band	Standard PP (SEK)	Optional PP (SEK)
	24125 FourSure® 99 with Loop Armrests, Inside upholstery, With tilt with gas	10.4		1 2 3 4 5 6 7 8 10	9.894 10.085 10.277 10.466 10.658 10.849 11.040 11.230 11.614	10.085 10.276 10.468 10.657 10.849 11.040 11.231 11.421 11.805
	24131 FourSure® 99 with Loop Armrests, Fully upholstered, With tilt	8.8		1 2 3 4 5 6 7 8 10	9.675 9.896 10.117 10.338 10.557 10.780 11.000 11.221 11.704	
	24133 FourSure® 99 with Loop Armrests, Fully upholstered, With tilt with return	8.8		1 2 3 4 5 6 7 8 10	10.175 10.396 10.617 10.838 11.057 11.280 11.500 11.721 12.204	
	24135 FourSure® 99 with Loop Armrests, Fully upholstered, With tilt with gas	8.5		1 2 3 4 5 6 7 8 10	10.175 10.396 10.617 10.838 11.057 11.280 11.500 11.721 12.204	

ACCESSORIES	Description	Weight (Kg)	Dimensions (mm)	Price (SEK)
	CHAIR FEET Castors			1.154
	CHAIR FEET Felt glides, set of 4 pcs. height + 0,2 cm	1,82 g x 4		208

SURCHARGE		Price (SEK)
FRAME OPTIONAL	 B C K	1058



FEATURES

- Swivel auditorium chair
- TABB and TABC as standard
- InnoTab options
- Return function and gas lift options
- Black powder coated frame as standard
- Writing tablet, laminate tablets in white or anthracite options

For product information visit fourdesign.dk ↗

SHELL COLOURS

Standard Polypropylene



FRAME COLOURS

Standard





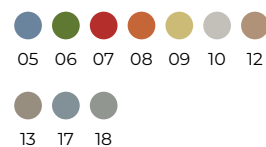





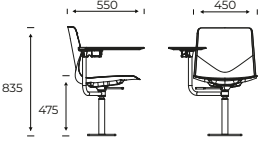

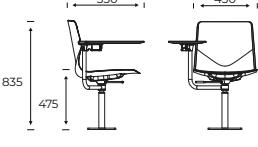
Optional Polypropylene

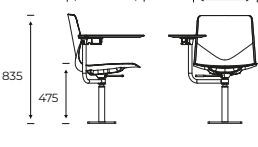

For full colour details [go to page 156](#) ↗

Product	Description (Item nr)	Weight (Kg)	Dimensions (mm)	Band	Standard PP (SEK)	Optional PP (SEK)
	27001 FourSure® Audi, Polypropylene shell, With tilt	9.1		-	7.310	7.501
	27003 FourSure® Audi, Polypropylene shell, With tilt with return	9.1		-	7.867	8.058
	27005 FourSure® Audi, Polypropylene shell, With tilt with gas	11.6		-	8.048	8.239
	27011 FourSure® Audi, Seat pad, With tilt	9.6		1 2 3 4 5 6 7 8 10	8.572 8.667 8.762 8.856 8.948 9.044 9.139 9.233 9.451	8.763 8.858 8.953 9.047 9.139 9.235 9.330 9.424 9.642

Product	Description (Item nr)	Weight (Kg)	Dimensions (mm)	Band	Standard PP (SEK)	Optional PP (SEK)
	27013 FourSure® Audi, Seat pad, With tilt with return	9.6		1	9.129	9.320
				2	9.224	9.415
				3	9.319	9.510
				4	9.413	9.604
				5	9.505	9.696
				6	9.601	9.792
				7	9.696	9.887
				8	9.790	9.981
				10	10.008	10.199
					27015 FourSure® Audi, Seat pad, With tilt with gas	9.7
2	9.405	9.596				
3	9.500	9.691				
4	9.594	9.785				
5	9.686	9.877				
6	9.782	9.973				
7	9.877	10.068				
8	9.971	10.162				
10	10.189	10.380				
	27031 FourSure® Audi, Fully upholstered, With tilt	11.8				
				2	10.230	
				3	10.451	
				4	10.672	
				5	10.891	
				6	11.114	
				7	11.334	
				8	11.555	
				10	12.038	
					27033 FourSure® Audi, Fully upholstered, With tilt with return	11.8
2	10.787					
3	11.008					
4	11.229					
5	11.448					
6	11.671					
7	11.891					
8	12.112					
10	12.595					
	27035 FourSure® Audi, Fully upholstered, With tilt with gas	11.9				
				2	10.968	
				3	11.189	
				4	11.410	
				5	11.629	
				6	11.852	
				7	12.072	
				8	12.293	
				10	12.776	

ACCESSORIES	Description	Weight (Kg)	Dimensions (mm)	Price (SEK)
	FOOTRING Gas lift including footring Spand 41 cm. - 57,5 cm.		585 - 845 mm	1.368
	INNO Without InnoNote			1.708
	INNO TABB: Writing tablet in white and powder coated frame with integral cup holder and coat hook.	1,5 KG	585 x 308 mm	
	INNO TABB: Writing tablet in anthracite and powder coated frame with integral cup holder and coat hook.	1,5 KG	585 x 308 mm	
	INNO TABC: Writing tablet in white and powder coated frame with integral cup holder and coat hook.	1 KG	475 x 278 mm	
	INNO TABC: Writing tablet in anthracite and powder coated frame with integral cup holder and coat hook.	1 KG	475 x 278 mm	
	INNO Foldable Inno® Tab in black with integrated cup holder and dashboard for tablet and phone.	2,7 KG	520 x 320 x 230 mm	

Design by Strand+Hvass



FEATURES

- The chair consists of 50 % recycled plastic
- Limitation of substances that are harmful to health and the environment
- Linking device optional on frames or under seat
- Matches table height 74 cm, 90 cm & 105 cm
- Polyamide glides as standard
- Stackable on matching trolley

For product information visit fourdesign.dk ↗

SHELL COLOURS

Standard Polypropylene



02 03







FRAME COLOURS

Standard

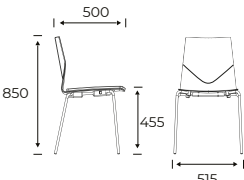

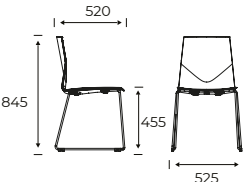
B K

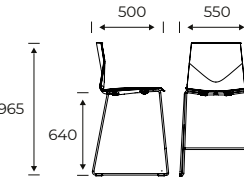

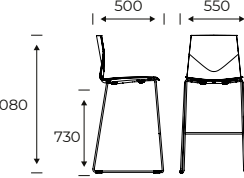
For full colour details [go to page 156](#) ↗







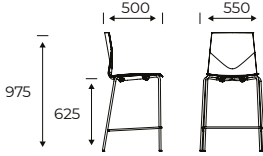

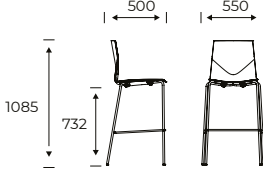
Product	Description (Item nr)	Weight (Kg)	Stacking on floor	Dimensions (mm)	Band	Standard PP (SEK)
	32500 FourCast® 2 Four, Polypropylene shell	4.8	-		-	2.290
	33200 FourCast® 2 Line, Polypropylene shell	5.7	-		-	2.776
	33800 FourCast® 2 Counter, Polypropylene shell	6.6	-		-	3.730
	33900 FourCast® 2 High, Polypropylene shell	7.3	-		-	3.815

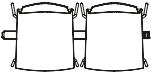
EU Ecolabel FourCast® 2

[Content ↗](#)

Design by Strand+Hvass

Product	Description (Item nr)	Weight (Kg)	Stacking on floor	Dimensions (mm)	Band	Standard PP (SEK)
	34000 FourCast@ 2 Counter Four, Polypropylene shell	7.7	-		-	3.492
	34100 FourCast@ 2 High Four, Polypropylene shell	6.7	-		-	3.492

ACCESSORIES	Description	Weight (Kg)	Dimensions (mm)	Price (SEK)
	CHAIR FEET Felt glides, set of 4 pcs. height + 0,2 cm	1,82 g x 4		208
	CHAIR FEET Teflon glides, set of 4 pcs. Chair height + 0,2 cm	2,75 g x 4		208
	LINKING DEVICE Chair linking	0,4 KG	C/C 535 mm C/C with armrest 585 mm C/C with Loop armrest 625 mm	417
	LINKING DEVICE Chair linking		C/C 540 mm C/C with armrest 540 mm	390
	GRIP HOLE Available for chairs without inside – and full upholstery			189
	SEAT ROW NUMBER - ACSR0201 11 mm - no. 1 -25	29 g		1.579
	SEAT ROW NUMBER - ACSR0202 11 mm - no. 26 -50	29 g		1.579
	SEAT ROW NUMBER - ACSR0101 16 mm - no. 1 -25	29 g		1.579
	SEAT ROW NUMBER - ACSR0102 16 mm - no. 26 -50	29 g		1.579
	CHAIR TROLLEY - 200X0 25 chairs without upholstery	33,5 Kg	1100 x 560 x 1970 mm	8.859

FourCast® 2 Four

Design by Strand+Hvass

[Content ↗](#)



FEATURES

- Armrest options
- Wooden legs options
- Linking device under seat options
- Monochrome powder coating on frames options
- Polyamide glides as standard
- Inno® Note tablet options
- Stackable on matching trolley
- Outdoor options
- We do not recommend suspensions for fully upholstered version

For product information visit fourdesign.dk ↗

SHELL COLOURS

Standard Polypropylene



Optional Polypropylene

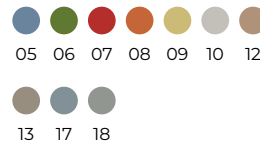

FRAME COLOURS

Standard



Frame optional*



For full colour details [go to page 156](#) ↗









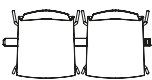
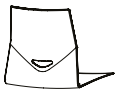

Product	Description (Item nr)	Weight (Kg)	Stacking on floor	Dimensions (mm)	Band	Standard PP (SEK)	Optional PP (SEK)
	32500 FourCast® 2 Four, Polypropylene shell	4.8	12		-	2.290	2.481
	32510 FourCast® 2 Four, Seat pad	5.8	10		1 2 3 4 5 6 7 8 10	3.552 3.647 3.742 3.836 3.928 4.024 4.119 4.213 4.431	3.743 3.838 3.933 4.027 4.119 4.215 4.310 4.404 4.622
	32530 FourCast® 2 Four, Fully upholstered	4.1	6		1 2 3 4 5 6 7 8 10	4.999 5.220 5.443 5.663 5.882 6.103 6.325 6.544 7.030	
	32600 FourCast® 2 Four with Armrests, Polypropylene shell	5.3	12		-	3.443	3.634

FourCast® 2 Four

Design by Strand+Hvass

[Content ↗](#)

Product	Description (Item nr)	Weight (Kg)	Stacking on floor	Dimensions (mm)	Band	Standard PP (SEK)	Optional PP (SEK)
	32610 FourCast@ 2 Four with Armrests, Seat pad	6.3	10		1 2 3 4 5 6 7 8 10	4.705 4.800 4.895 4.989 5.081 5.177 5.272 5.366 5.584	4.896 4.991 5.086 5.180 5.272 5.368 5.463 5.557 5.775
	32630 FourCast@ 2 Four with Armrests, Fully upholstered	4.6	6		1 2 3 4 5 6 7 8 10	6.152 6.373 6.596 6.816 7.035 7.256 7.478 7.697 8.183	
	32700 FourCast@ 2 Four with Loop Armrests, Polypropylene shell	5.9	12		-	3.443	3.634
	32710 FourCast@ 2 Four with Loop Armrests, Seat pad	6.8	10		1 2 3 4 5 6 7 8 10	4.705 4.800 4.895 4.989 5.081 5.177 5.272 5.366 5.584	4.896 4.991 5.086 5.180 5.272 5.368 5.463 5.557 5.775
	32730 FourCast@ 2 Four with Loop Armrests, Fully upholstered	5.2	6		1 2 3 4 5 6 7 8 10	6.152 6.373 6.596 6.816 7.035 7.256 7.478 7.697 8.183	
	32500 FourCast@ 2 Four, Polypropylene shell, Oak oil, nature	4.8	-		-	3.623	3.814
	32510 FourCast@ 2 Four, Seat pad, Oak oil, nature	5.8	-		1 2 3 4 5 6 7 8 10	4.885 4.980 5.075 5.169 5.261 5.357 5.452 5.546 5.764	5.076 5.171 5.266 5.360 5.452 5.548 5.643 5.737 5.955
	32530 FourCast@ 2 Four, Fully upholstered, Oak oil, nature	4.1	-		1 2 3 4 5 6 7 8 10	6.332 6.553 6.776 6.996 7.215 7.436 7.658 7.877 8.363	

ACCESSORIES	Description	Weight (Kg)	Dimensions (mm)	Price (SEK)
	CHAIR FEET Felt glides, set of 4 pcs. height + 0,2 cm	1,82 g x 4		208
	CHAIR FEET Set of 4 pcs. Noise reducing ferrule with big diameter (reduces pressure marks) Chair height + 0,8 cm	4,8 g x 4		276
	CHAIR FEET Noise reducing ferrule with felt, set of 4 pcs. Chair height + 1 cm	6,6 g x 4		276
	CHAIR FEET Teflon glides, set of 4 pcs. Chair height + 0,2 cm	2,75 g x 4		208
	LINKING DEVICE Chair linking	0,4 KG	C/C 535 mm C/C with armrest 585 mm C/C with Loop armrest 625 mm	417
	GRIP HOLE Available for chairs without inside – and full upholstery			189
	INNO Inno® Note in black, removable and foldable. Not available for chairs with Loop armrest and chairs with wooden legs.	1,2 KG	225 x 325 x 20 mm	1.522
	SEAT ROW NUMBER - ACSR0101 16 mm - no.1 -25	29 g		1.579
	SEAT ROW NUMBER - ACSR0102 16 mm - no. 26 -50	29 g		1.579
	INNO@NOTE TROLLEY - 20100007 Trolley for Inno® Note. Room for 51 Inno® Notes.	58,5 Kg	1532 x 662 x 1199 mm	19.942
	CHAIR TROLLEY - 200X0 25 chairs without upholstery	33,5 Kg	1100 x 560 x 1970 mm	8.859
	CHAIR TROLLEY - 200X0 20 chairs with seat pad or 18 chairs with full upholstery	33,5 Kg	1100 x 560 x 1910 / 1980 mm	10.373
	SACK TROLLEY - 200X1 12 chairs without upholstery, 10 chairs with full upholstery			4.918

FourCast® 2 Four

Design by Strand+Hvass

[Content ↗](#)

SURCHARGE		Price (SEK)
FRAME OPTIONAL	 7 A D E F M N O Q S T	194
	 P	473

FourCast® 2 Four - Veneer

Design by Strand+Hvass

[Content](#)



FEATURES

- Armrest options
- Wooden legs options
- Linking device under seat options
- Monochrome powder coating on frames options
- Polyamide glides as standard
- Inno® Note tablet options
- Stackable on matching trolley
- We do not recommend suspensions to black lacquered versions

For product information visit fourdesign.dk

SHELL COLOURS

Veneer



FRAME COLOURS







Standard

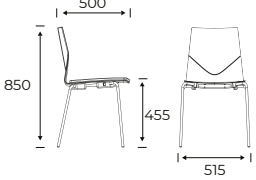

Frame optional*

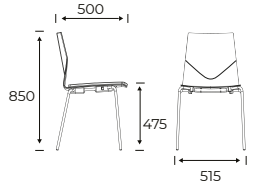

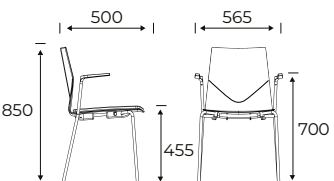

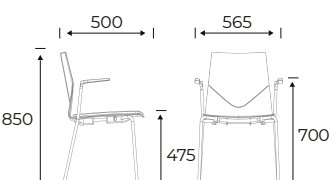



For full colour details [go to page 156](#)

Product	Description (Item nr)	Weight (Kg)	Stacking on floor	Dimensions (mm)	Band	Veneer (SEK)
	32540 FourCast® 2 Four, Wooden shell	3.3	12		-	3.212
	32550 FourCast® 2 Four, Seat pad, wooden shell	4.8	10		1 2 3 4 5 6 7 8 10	4.474 4.569 4.664 4.758 4.850 4.946 5.041 5.135 5.353
	32640 FourCast® 2 Four with Armrests, Wooden shell	3.9	6		-	4.365
	32650 FourCast® 2 Four with Armrests, Seat pad, wooden shell	5.3	12		1 2 3 4 5 6 7 8 10	5.627 5.722 5.817 5.911 6.003 6.099 6.194 6.288 6.506

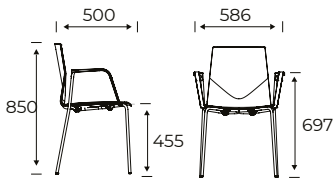
FourCast® 2 Four - Veneer

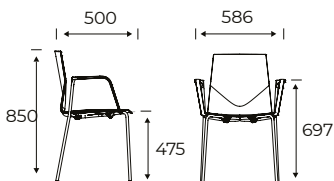
[Content ↗](#)

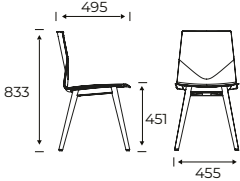

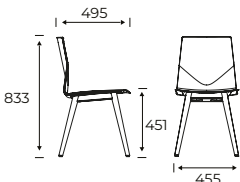





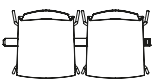
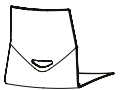

Design by Strand+Hvass

Product	Description (Item nr)	Weight (Kg)	Stacking on floor	Dimensions (mm)	Band	Veneer (SEK)
	32740 FourCast@ 2 Four with Loop Armrests, Wooden shell	4.4	10		-	4.365
	32750 FourCast@ 2 Four with Loop Armrests, Seat pad, wooden shell	5.8	6		1 2 3 4 5 6 7 8 10	5.627 5.722 5.817 5.911 6.003 6.099 6.194 6.288 6.506
	32540 FourCast@ 2 Four, Wooden shell, Oak oil, nature	3.3	-		-	4.545
	32550 FourCast@ 2 Four, Seat pad, wooden shell, Oak oil, nature	4.8	-		1 2 3 4 5 6 7 8 10	5.807 5.902 5.997 6.091 6.183 6.279 6.374 6.468 6.686

FourCast® 2 Four - Veneer

Design by Strand+Hvass



[Content ↗](#)

ACCESSORIES	Description	Weight (Kg)	Dimensions (mm)	Price (SEK)
	CHAIR FEET Felt glides, set of 4 pcs. height + 0,2 cm	1,82 g x 4		208
	CHAIR FEET Set of 4 pcs. Noise reducing ferrule with big diameter (reduces pressure marks) Chair height + 0,8 cm	4,8 g x 4		276
	CHAIR FEET Noise reducing ferrule with felt, set of 4 pcs. Chair height + 1 cm	6,6 g x 4		276
	CHAIR FEET Teflon glides, set of 4 pcs. Chair height + 0,2 cm	2,75 g x 4		208
	LINKING DEVICE Chair linking	0,4 KG	C/C 535 mm C/C with armrest 585 mm C/C with Loop armrest 625 mm	417
	GRIP HOLE Available for chairs without inside – and full upholstery			189
	INNO Inno® Note in black, removable and foldable. Not available for chairs with Loop armrest and chairs with wooden legs.	1,2 KG	225 x 325 x 20 mm	1.522
	SEAT ROW NUMBER - ACSR0101 16 mm - no.1 -25	29 g		1.579
	SEAT ROW NUMBER - ACSR0102 16 mm - no. 26 -50	29 g		1.579
	INNO@NOTE TROLLEY - 20100007 Trolley for Inno® Note. Room for 51 Inno® Notes.	58,5 Kg	1532 x 662 x 1199 mm	19.942
	CHAIR TROLLEY - 200X0 25 chairs without upholstery	33,5 Kg	1100 x 560 x 1970 mm	8.859
	CHAIR TROLLEY - 200X0 20 chairs with seat pad or 18 chairs with full upholstery	33,5 Kg	1100 x 560 x 1910 / 1980 mm	10.373
	SACK TROLLEY - 200X1 12 chairs without upholstery, 10 chairs with full upholstery			4.918

FourCast® 2 Four - Veneer

Design by Strand+Hvass

[Content ↗](#)

SURCHARGE		Price (SEK)
FRAME OPTIONAL	 7 A D E F M N O Q S T	194
	 P	473

FourCast® 2 Line

Design by Strand+Hvass

[Content ↗](#)



FEATURES

- Armrest options
- Linking device optional on frames or under seat
- Monochrome powder coating on frames options
- Polyamide glides as standard
- Inno® Note tablet options
- Stackable on matching trolley
- Outdoor options
- We do not recommend suspensions for fully upholstered version

For product information visit fourdesign.dk ↗

SHELL COLOURS

Standard Polypropylene



Optional Polypropylene

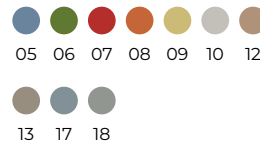

FRAME COLOURS

Standard



Frame optional*





For full colour details [go to page 156](#) ↗







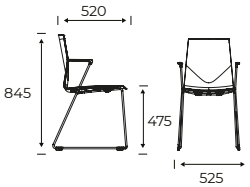

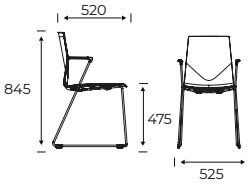

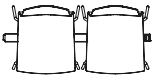
Product	Description (Item nr)	Weight (Kg)	Stacking on floor	Dimensions (mm)	Band	Standard PP (SEK)	Optional PP (SEK)
	33200 FourCast® 2 Line, Polypropylene shell	5.7	12		-	2.776	2.967
	33210 FourCast® 2 Line, Seat pad	6.7	10		1 2 3 4 5 6 7 8 10	4.038 4.133 4.228 4.322 4.414 4.510 4.605 4.699 4.917	4.229 4.324 4.419 4.513 4.605 4.701 4.796 4.890 5.108
	33230 FourCast® 2 Line, Fully upholstered	5	8		1 2 3 4 5 6 7 8 10	5.485 5.706 5.929 6.149 6.368 6.589 6.811 7.030 7.516	
	33300 FourCast® 2 Line with Armrests, Polypropylene shell	6.5	12		-	3.715	3.906

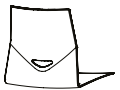
FourCast® 2 Line

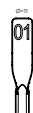
Design by Strand+Hvass

[Content ↗](#)

Product	Description (Item nr)	Weight (Kg)	Stacking on floor	Dimensions (mm)	Band	Standard PP (SEK)	Optional PP (SEK)
	33310 FourCast® 2 Line with Armrests, Seat pad	7.4	10		1 2 3 4 5 6 7 8 10	4.977 5.072 5.167 5.261 5.353 5.449 5.544 5.638 5.856	5.168 5.263 5.358 5.452 5.544 5.640 5.735 5.829 6.047
	33330 FourCast® 2 Line with Armrests, Fully upholstered	5.8	8		1 2 3 4 5 6 7 8 10	6.424 6.645 6.868 7.088 7.307 7.528 7.750 7.969 8.455	

ACCESSORIES	Description	Weight (Kg)	Dimensions (mm)	Price (SEK)
	CHAIR FEET Felt glides, set of 4 pcs. height + 0,2 cm	1,82 g x 4		208
	CHAIR FEET Teflon glides, set of 4 pcs. Chair height + 0,2 cm	2,75 g x 4		208
	LINKING DEVICE Chair linking	0,4 KG	C/C 535 mm C/C with armrest 585 mm C/C with Loop armrest 625 mm	417
	LINKING DEVICE Chair linking		C/C 540 mm C/C with armrest 540 mm	390
	GRIP HOLE Available for chairs without inside - and full upholstery			189
	INNO Inno® Note in black, removable and foldable. Not available for chairs with Loop armrest and chairs with wooden legs.	1,2 KG	225 x 325 x 20 mm	1.522
	SEAT ROW NUMBER - ACSR0201 11 mm - no. 1-25	29 g		1.579
	SEAT ROW NUMBER - ACSR0202 11 mm - no. 26-50	29 g		1.579
	INNO@NOTE TROLLEY - 20100007 Trolley for Inno® Note. Room for 51 Inno® Notes.	58,5 Kg	1532 x 662 x 1199 mm	19.942
	CHAIR TROLLEY - 200X0 30 chairs without upholstery	33,5 Kg	1100 x 560 x 1970 mm	8.859
	CHAIR TROLLEY - 200X0 19 chairs with seat pad or 20 chairs with full upholstery	33,5 Kg	1100 x 560 x 1910 / 1980 mm	10.373
	SACK TROLLEY - 200X1 12 chairs without upholstery, 10 chairs with full upholstery			4.918

SURCHARGE		Price (SEK)
FRAME OPTIONAL	 7 A D E F M N O Q S T	194

FourCast® 2 Line - Veneer

Design by Strand+Hvass

[Content ↗](#)



FEATURES

- Armrest options
- Linking device optional on frames or under seat
- Monochrome powder coating on frames options
- Polyamide glides as standard
- Inno® Note tablet options
- Stackable on matching trolley
- We do not recommend suspensions to black lacquered versions

For product information visit fourdesign.dk ↗

SHELL COLOURS

Veneer



FRAME COLOURS

Standard

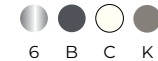

Frame optional*











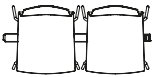

For full colour details [go to page 156](#) ↗

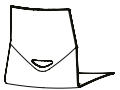
Product	Description (Item nr)	Weight (Kg)	Stacking on floor	Dimensions (mm)	Band	Veneer (SEK)
	33240 FourCast® 2 Line, Wooden shell	4.3	12		-	3.698
	33250 FourCast® 2 Line, Seat pad, wooden shell	5.6	10		1 2 3 4 5 6 7 8 10	4.960 5.055 5.150 5.244 5.336 5.432 5.527 5.621 5.839
	33340 FourCast® 2 Line with Armrests, Wooden shell	5	8		-	4.637
	33350 FourCast® 2 Line with Armrests, Seat pad, wooden shell	6.4	10		1 2 3 4 5 6 7 8 10	5.899 5.994 6.089 6.183 6.275 6.371 6.466 6.560 6.778

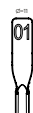
FourCast® 2 Line - Veneer

Design by Strand+Hvass

[Content ↗](#)

ACCESSORIES	Description	Weight (Kg)	Dimensions (mm)	Price (SEK)
	CHAIR FEET Felt glides, set of 4 pcs. height + 0,2 cm	1,82 g x 4		208
	CHAIR FEET Teflon glides, set of 4 pcs. Chair height + 0,2 cm	2,75 g x 4		208
	LINKING DEVICE Chair linking	0,4 KG	C/C 535 mm C/C with armrest 585 mm C/C with Loop armrest 625 mm	417
	LINKING DEVICE Chair linking		C/C 540 mm C/C with armrest 540 mm	390
	GRIP HOLE Available for chairs without inside - and full upholstery			189
	INNO Inno® Note in black, removable and foldable. Not available for chairs with Loop armrest and chairs with wooden legs.	1,2 KG	225 x 325 x 20 mm	1.522
	SEAT ROW NUMBER - ACSR0201 11 mm - no. 1-25	29 g		1.579
	SEAT ROW NUMBER - ACSR0202 11 mm - no. 26-50	29 g		1.579
	INNO@NOTE TROLLEY - 20100007 Trolley for Inno® Note. Room for 51 Inno® Notes.	58,5 Kg	1532 x 662 x 1199 mm	19.942
	CHAIR TROLLEY - 200X0 30 chairs without upholstery	33,5 Kg	1100 x 560 x 1970 mm	8.859
	CHAIR TROLLEY - 200X0 19 chairs with seat pad or 20 chairs with full upholstery	33,5 Kg	1100 x 560 x 1910 / 1980 mm	10.373
	SACK TROLLEY - 200X1 12 chairs without upholstery, 10 chairs with full upholstery			4.918

SURCHARGE		Price (SEK)
FRAME OPTIONAL	 7 A D E F M N O Q S T	194

FourCast® 2 Counter

Design by Strand+Hvass

[Content ↗](#)



FEATURES

- Fits table height 90 cm
- Stackable on floor
- Polyamide glides as standard
- Monochrome powder coating on frames options
- Outdoor options
- We do not recommend suspensions to fully upholstered version

For product information visit fourdesign.dk ↗

SHELL COLOURS

Standard Polypropylene



FRAME COLOURS

Standard



Optional Polypropylene

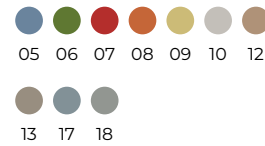

Frame optional*





For full colour details [go to page 156](#) ↗

Product	Description (Item nr)	Weight (Kg)	Stacking on floor	Dimensions (mm)	Band	Standard PP (SEK)	Optional PP (SEK)
	33800 FourCast® 2 Counter, Polypropylene shell	6.6	4		-	3.730	3.921
	33810 FourCast® 2 Counter, Seat pad	7.5	4		1 2 3 4 5 6 7 8 10	4.992 5.087 5.182 5.276 5.368 5.464 5.559 5.653 5.871	5.183 5.278 5.373 5.467 5.559 5.655 5.750 5.844 6.062
	33830 FourCast® 2 Counter, Fully upholstered	7.1	4		1 2 3 4 5 6 7 8 10	6.439 6.660 6.883 7.103 7.322 7.543 7.765 7.984 8.470	

FourCast® 2 Counter

Design by Strand+Hvass

[Content ↗](#)

ACCESSORIES	Description	Weight (Kg)	Dimensions (mm)	Price (SEK)
	CHAIR FEET Felt glides, set of 4 pcs. height + 0,2 cm	1,82 g x 4		208
	CHAIR FEET Teflon glides, set of 4 pcs. Chair height + 0,2 cm	2,75 g x 4		208
	GRIP HOLE Available for chairs without inside – and full upholstery			189
SURCHARGE				Price (SEK)
FRAME OPTIONAL	 7 A D E F M N O Q S T			194

FourCast® 2 Counter - Veneer

Design by Strand+Hvass

[Content ↗](#)



FEATURES

- Fits table height 90 cm
- Stackable on floor
- Polyamide glides as standard
- Monochrome powder coating on frames options
- We do not recommend suspensions to black lacquered versions

For product information visit fourdesign.dk ↗

SHELL COLOURS

Veneer



FRAME COLOURS

Standard



Frame optional*



For full colour details [go to page 156](#) ↗

Product	Description (Item nr)	Weight (Kg)	Stacking on floor	Dimensions (mm)	Band	Veneer (SEK)
	33840 FourCast® 2 Counter, Wooden shell	7.2	4		-	4.652
	33850 FourCast® 2 Counter, Seat pad, wooden shell	8.6	4		1 2 3 4 5 6 7 8 10	5.914 6.009 6.104 6.198 6.290 6.386 6.481 6.575 6.793

ACCESSORIES	Description	Weight (Kg)	Dimensions (mm)	Price (SEK)
	CHAIR FEET Felt glides, set of 4 pcs. height + 0,2 cm	1,82 g x 4		208
	CHAIR FEET Teflon glides, set of 4 pcs. Chair height + 0,2 cm	2,75 g x 4		208
	GRIP HOLE Available for chairs without inside - and full upholstery			189

FourCast® 2 Counter - Veneer

Design by Strand+Hvass

[Content ↗](#)

SURCHARGE		Price (SEK)
FRAME OPTIONAL	 <p>7 A D E F M N O Q S T</p>	194

FourCast® 2 High

Design by Strand+Hvass

[Content ↗](#)



FEATURES

- Fits table height 105 cm
- Stackable on floor
- Polyamide glides as standard
- Monochrome powder coating on frames options
- Outdoor options
- We do not recommend suspensions to fully upholstered version

For product information visit fourdesign.dk ↗

SHELL COLOURS

Standard Polypropylene



FRAME COLOURS

Standard



Optional Polypropylene

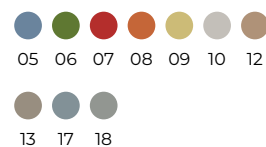

Frame optional*





For full colour details [go to page 156](#) ↗

Product	Description (Item nr)	Weight (Kg)	Stacking on floor	Dimensions (mm)	Band	Standard PP (SEK)	Optional PP (SEK)
	33900 FourCast® 2 High, Polypropylene shell	7.3	4		-	3.815	4.006
	33910 FourCast® 2 High, Seat pad	8.3	4		1 2 3 4 5 6 7 8 10	5.077 5.172 5.267 5.361 5.453 5.549 5.644 5.738 5.956	5.268 5.363 5.458 5.552 5.644 5.740 5.835 5.929 6.147
	33930 FourCast® 2 High, Fully upholstered	7.8	4		1 2 3 4 5 6 7 8 10	6.524 6.745 6.968 7.188 7.407 7.628 7.850 8.069 8.555	

FourCast® 2 High

Design by Strand+Hvass

[Content ↗](#)

ACCESSORIES	Description	Weight (Kg)	Dimensions (mm)	Price (SEK)
	CHAIR FEET Felt glides, set of 4 pcs. height + 0,2 cm	1,82 g x 4		208
	CHAIR FEET Teflon glides, set of 4 pcs. Chair height + 0,2 cm	2,75 g x 4		208
	GRIP HOLE Available for chairs without inside – and full upholstery			189
SURCHARGE				Price (SEK)
FRAME OPTIONAL	 7 A D E F M N O Q S T			194

FourCast® 2 High - Veneer

Design by Strand+Hvass

[Content ↗](#)

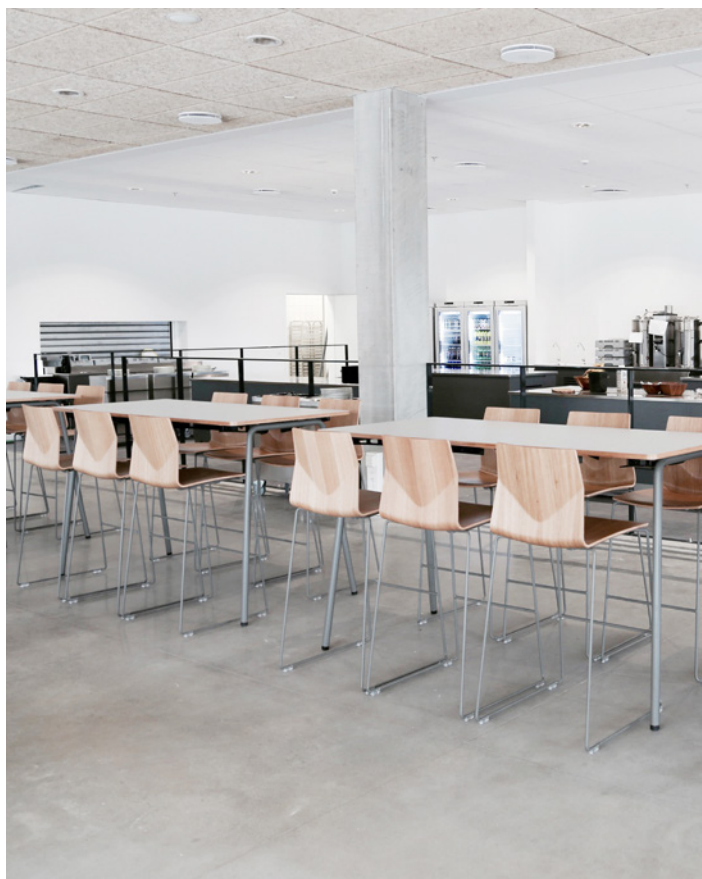

FEATURES

- Fits table height 105 cm
- Stackable on floor
- Polyamide glides as standard
- Monochrome powder coating on frames options
- We do not recommend suspensions to black lacquered versions

For product information visit fourdesign.dk ↗

SHELL COLOURS

Veneer



FRAME COLOURS

Standard



Frame optional*



For full colour details [go to page 156](#) ↗

Product	Description (Item nr)	Weight (Kg)	Stacking on floor	Dimensions (mm)	Band	Veneer (SEK)
	33940 FourCast® 2 High, Wooden shell	8	4		-	4.737
	33950 FourCast® 2 High, Seat pad, wooden shell	9.4	4		1 2 3 4 5 6 7 8 10	5.999 6.094 6.189 6.283 6.375 6.471 6.566 6.660 6.878

ACCESSORIES	Description	Weight (Kg)	Dimensions (mm)	Price (SEK)
	CHAIR FEET Felt glides, set of 4 pcs. height + 0,2 cm	1,82 g x 4		208
	CHAIR FEET Teflon glides, set of 4 pcs. Chair height + 0,2 cm	2,75 g x 4		208
	GRIP HOLE Available for chairs without inside - and full upholstery			189

FourCast® 2 High - Veneer

Design by Strand+Hvass

[Content ↗](#)

SURCHARGE		Price (SEK)
FRAME OPTIONAL	 <p>7 A D E F M N O Q S T</p>	194

FourCast® 2 Counter Four

Design by Strand+Hvass

[Content ↗](#)



FEATURES

- Fits table height 90 cm
- Stackable on floor
- Polyamide glides as standard
- Monochrome powder coating on frames options
- We do not recommend suspensions to fully upholstered version

For product information visit fourdesign.dk ↗

SHELL COLOURS

Standard Polypropylene



FRAME COLOURS

Standard



Optional Polypropylene

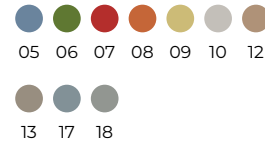

Frame optional*





For full colour details [go to page 156](#) ↗

Product	Description (Item nr)	Weight (Kg)	Stacking on floor	Dimensions (mm)	Band	Standard PP (SEK)	Optional PP (SEK)
	34000 FourCast® 2 Counter Four, Polypropylene shell	7.7	4		-	3.492	3.683
	34010 FourCast® 2 Counter Four, Seat pad	8.6	4		1 2 3 4 5 6 7 8 10	4.754 4.849 4.944 5.038 5.130 5.226 5.321 5.415 5.633	4.945 5.040 5.135 5.229 5.321 5.417 5.512 5.606 5.824
	34030 FourCast® 2 Counter Four, Fully upholstered	8.2	4		1 2 3 4 5 6 7 8 10	6.201 6.422 6.645 6.865 7.084 7.305 7.527 7.746 8.232	

FourCast® 2 Counter Four

Design by Strand+Hvass

[Content ↗](#)

ACCESSORIES	Description	Weight (Kg)	Dimensions (mm)	Price (SEK)
	CHAIR FEET Felt glides, set of 4 pcs. height + 0,2 cm	1,82 g x 4		208
	CHAIR FEET Teflon glides, set of 4 pcs. Chair height + 0,2 cm	2,75 g x 4		208
	GRIP HOLE Available for chairs without inside – and full upholstery			189
SURCHARGE				Price (SEK)
FRAME OPTIONAL	 <p>7 A D E F M N O Q S T</p>			194

FourCast® 2 Counter Four - Veneer

[Content ↗](#)

Design by Strand+Hvass



FEATURES

- Fits table height 90 cm
- Stackable on floor
- Polyamide glides as standard
- Monochrome powder coating on frames options
- We do not recommend suspensions to black lacquered versions

For product information visit fourdesign.dk ↗

SHELL COLOURS

Veneer



FRAME COLOURS



Standard



Frame optional*

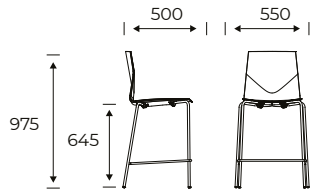

For full colour details [go to page 156](#) ↗

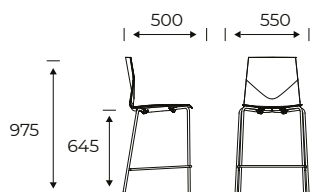
Product	Description (Item nr)	Weight (Kg)	Stacking on floor	Dimensions (mm)	Band	Veneer (SEK)
	34040 FourCast® 2 Counter Four, Wooden shell	8.3	4		-	4.414
	34050 FourCast® 2 Counter Four, Seat pad, wooden shell	9.7	4		1 2 3 4 5 6 7 8 10	5.676 5.771 5.866 5.960 6.052 6.148 6.243 6.337 6.555

ACCESSORIES	Description	Weight (Kg)	Dimensions (mm)	Price (SEK)
	CHAIR FEET Felt glides, set of 4 pcs. height + 0,2 cm	1,82 g x 4		208
	CHAIR FEET Teflon glides, set of 4 pcs. Chair height + 0,2 cm	2,75 g x 4		208
	GRIP HOLE Available for chairs without inside - and full upholstery			189

FourCast® 2 Counter Four - Veneer

Design by Strand+Hvass

[Content ↗](#)

SURCHARGE		Price (SEK)
FRAME OPTIONAL	 7 A D E F M N O Q S T	194

FourCast® 2 High Four

Design by Strand+Hvass

[Content ↗](#)



FEATURES

- Fits table height 105 cm
- Stackable on floor
- Polyamide glides as standard
- Monochrome powder coating on frames options
- We do not recommend suspensions to fully upholstered version

For product information visit fourdesign.dk ↗

SHELL COLOURS

Standard Polypropylene



FRAME COLOURS

Standard



Optional Polypropylene

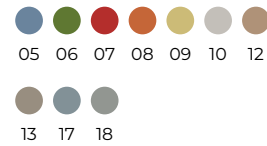

Frame optional*





For full colour details [go to page 156](#) ↗

Product	Description (Item nr)	Weight (Kg)	Stacking on floor	Dimensions (mm)	Band	Standard PP (SEK)	Optional PP (SEK)
	34100 FourCast® 2 High Four, Polypropylene shell	6.7	4		-	3.492	3.683
	34110 FourCast® 2 High Four, Seat pad	7.7	4		1 2 3 4 5 6 7 8 10	4.754 4.849 4.944 5.038 5.130 5.226 5.321 5.415 5.633	4.945 5.040 5.135 5.229 5.321 5.417 5.512 5.606 5.824
	34130 FourCast® 2 High Four, Fully upholstered	7.2	4		1 2 3 4 5 6 7 8 10	6.201 6.422 6.645 6.865 7.084 7.305 7.527 7.746 8.232	

FourCast® 2 High Four

Design by Strand+Hvass

[Content ↗](#)

ACCESSORIES	Description	Weight (Kg)	Dimensions (mm)	Price (SEK)
	CHAIR FEET Felt glides, set of 4 pcs. height + 0,2 cm	1,82 g x 4		208
	CHAIR FEET Teflon glides, set of 4 pcs. Chair height + 0,2 cm	2,75 g x 4		208
	GRIP HOLE Available for chairs without inside – and full upholstery			189
SURCHARGE				Price (SEK)
FRAME OPTIONAL	 7 A D E F M N O Q S T			194

FourCast® 2 High Four - Veneer

Design by Strand+Hvass

[Content ↗](#)



FEATURES

- Fits table height 105 cm
- Stackable on floor
- Polyamide glides as standard
- Monochrome powder coating on frames options
- We do not recommend suspensions to black lacquered versions

For product information visit fourdesign.dk ↗

SHELL COLOURS

Veneer



FRAME COLOURS

Standard



Frame optional*



For full colour details [go to page 156](#) ↗

Product	Description (Item nr)	Weight (Kg)	Stacking on floor	Dimensions (mm)	Band	Veneer (SEK)
	34140 FourCast® 2 High Four, Wooden shell	7.4	4		-	4.414
	34150 FourCast® 2 High Four, Seat pad, wooden shell	8.8	4		1 2 3 4 5 6 7 8 10	5.676 5.771 5.866 5.960 6.052 6.148 6.243 6.337 6.555

ACCESSORIES	Description	Weight (Kg)	Dimensions (mm)	Price (SEK)
	CHAIR FEET Felt glides, set of 4 pcs. height + 0,2 cm	1,82 g x 4		208
	CHAIR FEET Teflon glides, set of 4 pcs. Chair height + 0,2 cm	2,75 g x 4		208
	GRIP HOLE Available for chairs without inside - and full upholstery			189

FourCast® 2 High Four - Veneer

Design by Strand+Hvass

[Content ↗](#)

SURCHARGE		Price (SEK)
FRAME OPTIONAL	 <p>7 A D E F M N O Q S T</p>	194

FourCast® 2 Wheeler

Design by Strand+Hvass

[Content ↗](#)



FEATURES

- Inno® Tab, flexible and rotating writing tablet options
- Gas lift, 41 - 57,5 cm
- Free Float options
- Black base with castors as standard
- Aluminium base options
- We do not recommend suspensions to fully upholstered version

For product information visit fourdesign.dk ↗

SHELL COLOURS

Standard Polypropylene



Optional Polypropylene

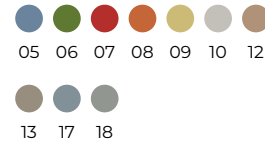

FRAME COLOURS

Standard



Frame optional*









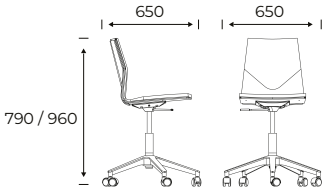

For full colour details [go to page 156](#) ↗

Product	Description (Item nr)	Weight (Kg)	Dimensions (mm)	Band	Standard PP (SEK)	Optional PP (SEK)
	35004 FourCast® 2 Wheeler, Polypropylene shell, Without tilt with gas	7.3		-	3.016	3.207
	35014 FourCast® 2 Wheeler, Seat pad, Without tilt with gas	7.9		1 2 3 4 5 6 7 8 10	4.278 4.373 4.468 4.562 4.654 4.750 4.845 4.939 5.157	4.469 4.564 4.659 4.753 4.845 4.941 5.036 5.130 5.348
	35034 FourCast® 2 Wheeler, Fully upholstered, Without tilt with gas	6.2		1 2 3 4 5 6 7 8 10	5.725 5.946 6.169 6.389 6.608 6.829 7.051 7.270 7.756	
	35005 FourCast® 2 Wheeler, Polypropylene shell, With tilt with gas	7.3		-	3.380	3.571

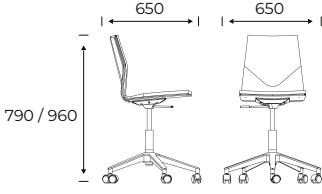
FourCast® 2 Wheeler

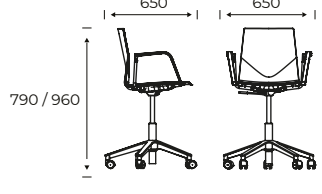
Design by Strand+Hvass

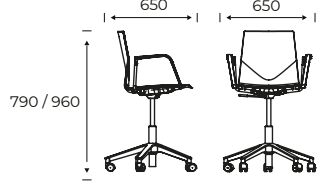

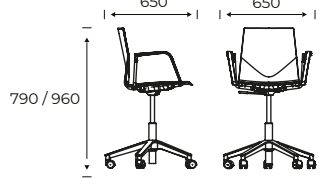



[Content ↗](#)

Product	Description (Item nr)	Weight (Kg)	Dimensions (mm)	Band	Standard PP (SEK)	Optional PP (SEK)
	35015 FourCast@ 2 Wheeler, Seat pad, With tilt with gas	7.9		1 2 3 4 5 6 7 8 10	4.642 4.737 4.832 4.926 5.018 5.114 5.209 5.303 5.521	4.833 4.928 5.023 5.117 5.209 5.305 5.400 5.494 5.712
	35035 FourCast@ 2 Wheeler, Fully upholstered, With tilt with gas	6.2		1 2 3 4 5 6 7 8 10	6.089 6.310 6.533 6.753 6.972 7.193 7.415 7.634 8.120	
	34905 FourCast@ 2 Wheeler with Loop Armrests, Polypropylene shell, With tilt with gas	8.5		-	4.524	4.715
	34915 FourCast@ 2 Wheeler with Loop Armrests, Seat pad, With tilt with gas	9.1		1 2 3 4 5 6 7 8 10	5.786 5.881 5.976 6.070 6.162 6.258 6.353 6.447 6.665	5.977 6.072 6.167 6.261 6.353 6.449 6.544 6.638 6.856
	34935 FourCast@ 2 Wheeler with Loop Armrests, Fully upholstered, With tilt with gas	7.4		1 2 3 4 5 6 7 8 10	7.233 7.454 7.677 7.897 8.116 8.337 8.559 8.778 9.264	

FourCast® 2 Wheeler

Design by Strand+Hvass

[Content ↗](#)

ACCESSORIES	Description	Weight (Kg)	Dimensions (mm)	Price (SEK)
	HOOK Hook in black			47
	CHAIR FEET Standard polymide glides. Chair height + 0,2 cm			
	FOOTRING Gas lift including footring Spand 41 cm. - 57,5 cm.		585 - 845 mm	1.368
	GRIP HOLE Available for chairs without inside – and full upholstery			189
	With GS certification			1.489
	INNO Foldable Inno® Tab in black with integrated cup holder and dashboard for tablet and phone.	2,7 KG	520 x 320 x 230 mm	2.125
SURCHARGE				Price (SEK)
FRAME OPTIONAL	 4			643

FourCast® 2 77

Design by Strand+Hvass

[Content ↗](#)



FEATURES

- Armrest options
- Stackable on floor
- Monochrome powder coating on frames options
- We do not recommend suspensions for fully upholstered version

For product information visit fourdesign.dk ↗

SHELL COLOURS

Standard Polypropylene



FRAME COLOURS

Standard

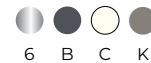

Optional Polypropylene

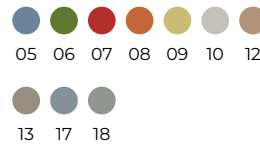

Frame optional*





For full colour details [go to page 156](#) ↗

Product	Description (Item nr)	Weight (Kg)	Stacking on floor	Dimensions (mm)	Band	Standard PP (SEK)	Optional PP (SEK)
	32800 FourCast® 2 77, Polypropylene shell	5.8	7		-	2.734	2.925
	32810 FourCast® 2 77, Seat pad	6.8	5		1 2 3 4 5 6 7 8 10	3.996 4.091 4.186 4.280 4.372 4.468 4.563 4.657 4.875	4.187 4.282 4.377 4.471 4.563 4.659 4.754 4.848 5.066
	32830 FourCast® 2 77, Fully upholstered	5.1	5		1 2 3 4 5 6 7 8 10	5.443 5.664 5.887 6.107 6.326 6.547 6.769 6.988 7.474	
	32900 FourCast® 2 77 with Armrests, Polypropylene shell	6.4	7		-	3.888	4.079

FourCast® 2 77

Design by Strand+Hvass

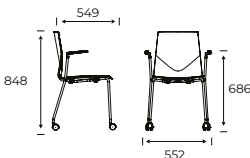
[Content ↗](#)

Product	Description (Item nr)	Weight (Kg)	Stacking on floor	Dimensions (mm)	Band	Standard PP (SEK)	Optional PP (SEK)
	32910 FourCast® 2 77 with Armrests, Seat pad	7.4	5		1	5.150	5.341
					2	5.245	5.436
					3	5.340	5.531
					4	5.434	5.625
					5	5.526	5.717
					6	5.622	5.813
					7	5.717	5.908
					8	5.811	6.002
					10	6.029	6.220
						32930 FourCast® 2 77 with Armrests, Fully upholstered	5.8
2	6.818						
3	7.041						
4	7.261						
5	7.480						
6	7.701						
7	7.923						
8	8.142						
10	8.628						

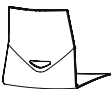
ACCESSORIES	Description	Weight (Kg)	Dimensions (mm)	Price (SEK)
	GRIP HOLE Available for chairs without inside – and full upholstery			189

SURCHARGE		Price (SEK)
FRAME OPTIONAL 		194

FourCast® 2 77 - Veneer

Design by Strand+Hvass

[Content ↗](#)



FEATURES

- Armrest options
- Stackable on floor
- Monochrome powder coating on frames options
- We do not recommend suspensions to black lacquered versions

For product information visit fourdesign.dk ↗

SHELL COLOURS

Veneer



FRAME COLOURS







Standard

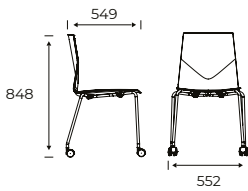

Frame optional*

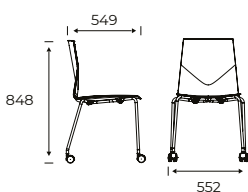

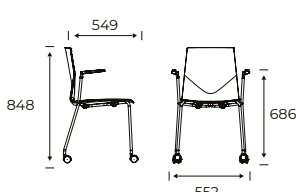
For full colour details [go to page 156](#) ↗

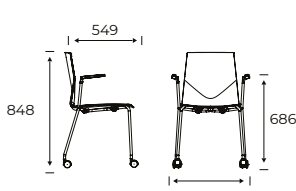
Product	Description (Item nr)	Weight (Kg)	Stacking on floor	Dimensions (mm)	Band	Veneer (SEK)
	32840 FourCast® 2 77, Wooden shell	4.4	-		-	3.656
	32850 FourCast® 2 77, Seat pad, wooden shell	5.8	5		1 2 3 4 5 6 7 8 10	4.918 5.013 5.108 5.202 5.294 5.390 5.485 5.579 5.797
	32940 FourCast® 2 77 with Armrests, Wooden shell	5	7		-	4.810
	32950 FourCast® 2 77 with Armrests, Seat pad, wooden shell	6.4	5		1 2 3 4 5 6 7 8 10	6.072 6.167 6.262 6.356 6.448 6.544 6.639 6.733 6.951

FourCast® 2 77 - Veneer

Design by Strand+Hvass

[Content ↗](#)

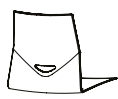
ACCESSORIES	Description	Weight (Kg)	Dimensions (mm)	Price (SEK)
	GRIP HOLE Available for chairs without inside – and full upholstery			189
SURCHARGE				Price (SEK)
FRAME OPTIONAL	 7 A D E F M N O Q S T			194



FEATURES

- Armrest options
- Swivel with freefloat in seat/back
- Return mechanism options
- Polyamide glides as standard
- Teflon or felt glides options
- Soft castor options (fixed cone without swivel and return)
- Monochrome powder coating on frames options
- We do not recommend suspensions to fully upholstered version

For product information visit fourdesign.dk ↗

SHELL COLOURS

Standard Polypropylene



FRAME COLOURS

Standard



Optional Polypropylene

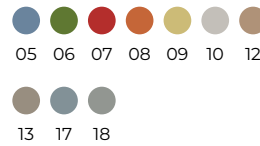











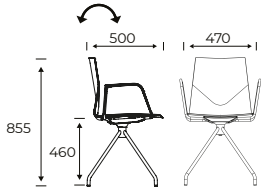

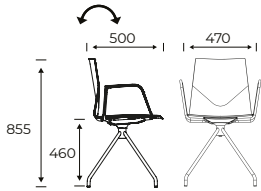

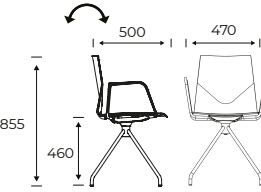
For full colour details [go to page 156](#) ↗

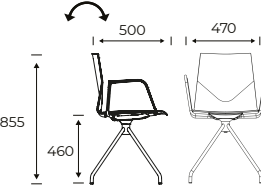

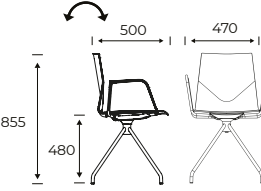
Product	Description (Item nr)	Weight (Kg)	Dimensions (mm)	Band	Standard PP (SEK)	Optional PP (SEK)
	33001 FourCast® 2 One, Polypropylene shell, With tilt	6.2		-	3.798	3.989
	33003 FourCast® 2 One, Polypropylene shell, With tilt with return	-		-	4.971	5.162
	33011 FourCast® 2 One, Seat pad, With tilt	6.8		1 2 3 4 5 6 7 8 10	5.060 5.155 5.250 5.344 5.436 5.532 5.627 5.721 5.939	5.251 5.346 5.441 5.535 5.627 5.723 5.818 5.912 6.130
	33013 FourCast® 2 One, Seat pad, With tilt with return	7		1 2 3 4 5 6 7 8 10	6.233 6.328 6.423 6.517 6.609 6.705 6.800 6.894 7.112	6.424 6.519 6.614 6.708 6.800 6.896 6.991 7.085 7.303

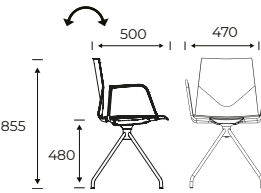
FourCast® 2 One

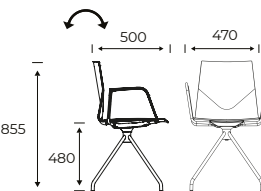
Design by Strand+Hvass

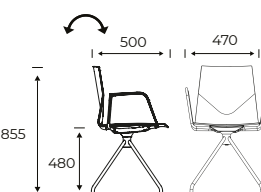
[Content ↗](#)

Product	Description (Item nr)	Weight (Kg)	Dimensions (mm)	Band	Standard PP (SEK)	Optional PP (SEK)
	33031 FourCast@ 2 One, Fully upholstered, With tilt	5.1		1 2 3 4 5 6 7 8 10	6.507 6.728 6.951 7.171 7.390 7.611 7.833 8.052 8.538	
	33033 FourCast@ 2 One, Fully upholstered, With tilt with return	5.3		1 2 3 4 5 6 7 8 10	7.680 7.901 8.124 8.344 8.563 8.784 9.006 9.225 9.711	
	33101 FourCast@ 2 One with Loop Armrests, Polypropylene shell, With tilt	7.6		-	4.951	5.142
	33103 FourCast@ 2 One with Loop Armrests, Polypropylene shell, With tilt with return	-		-	6.124	6.315
	33111 FourCast@ 2 One with Loop Armrests, Seat pad, With tilt	7.9		1 2 3 4 5 6 7 8 10	6.213 6.308 6.403 6.497 6.589 6.685 6.780 6.874 7.092	6.404 6.499 6.594 6.688 6.780 6.876 6.971 7.065 7.283
	33113 FourCast@ 2 One with Loop Armrests, Seat pad, With tilt with return	8.2		1 2 3 4 5 6 7 8 10	7.386 7.481 7.576 7.670 7.762 7.858 7.953 8.047 8.265	7.577 7.672 7.767 7.861 7.953 8.049 8.144 8.238 8.456
	33131 FourCast@ 2 One with Loop Armrests, Fully upholstered, With tilt	6.3		1 2 3 4 5 6 7 8 10	7.660 7.881 8.104 8.324 8.543 8.764 8.986 9.205 9.691	
	33133 FourCast@ 2 One with Loop Armrests, Fully upholstered, With tilt with return	6.5		1 2 3 4 5 6 7 8 10	8.833 9.054 9.277 9.497 9.716 9.937 10.159 10.378 10.864	

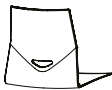
ACCESSORIES	Description	Weight (Kg)	Dimensions (mm)	Price (SEK)
	CHAIR FEET Castors			876
	CHAIR FEET Felt glides, set of 4 pcs. height + 0,2 cm	1,82 g x 4		208
	CHAIR FEET Set of 4 pcs. Noise reducing ferrule with big diameter (reduces pressure marks) Chair height + 0,8 cm	4,8 g x 4		276
	CHAIR FEET Noise reducing ferrule with felt, set of 4 pcs. Chair height + 1 cm	6,6 g x 4		276
	CHAIR FEET Teflon glides, set of 4 pcs. Chair height + 0,2 cm	2,75 g x 4		208
	GRIP HOLE Available for chairs without inside – and full upholstery			189

FourCast® 2 One - Veneer

Design by Strand+Hvass

[Content ↗](#)



FEATURES

- Armrest options
- Swivel with freefloat in seat/back
- Return mechanism options
- Polyamide glides as standard
- Teflon or felt glides and soft castor options
- We do not recommend suspensions to black lacquered versions

For product information visit fourdesign.dk ↗

SHELL COLOURS

Veneer







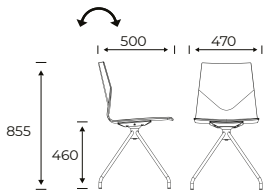

FRAME COLOURS

Standard

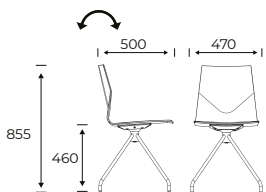

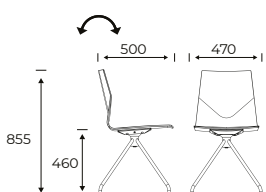

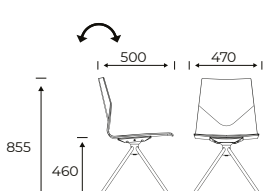



For full colour details [go to page 156](#) ↗

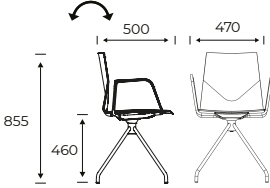

Product	Description (Item nr)	Weight (Kg)	Dimensions (mm)	Band	Veneer (SEK)	Optional PP (SEK)
	33041 FourCast@ 2 One, Wooden shell, With tilt	4.7		-	4.720	4.720
	33043 FourCast@ 2 One, Wooden shell, With tilt with return	5		-	5.893	5.893
	33051 FourCast@ 2 One, Seat pad, wooden shell, With tilt	5.8		1 2 3 4 5 6 7 8 10	5.982 6.077 6.172 6.266 6.358 6.454 6.549 6.643 6.861	5.982 6.077 6.172 6.266 6.358 6.454 6.549 6.643 6.861
	33053 FourCast@ 2 One, Seat pad, wooden shell, With tilt with return	5.9		1 2 3 4 5 6 7 8 10	7.155 7.250 7.345 7.439 7.531 7.627 7.722 7.816 8.034	7.155 7.250 7.345 7.439 7.531 7.627 7.722 7.816 8.034

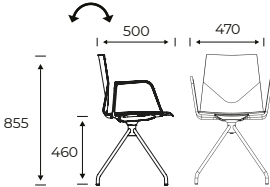
FourCast® 2 One - Veneer

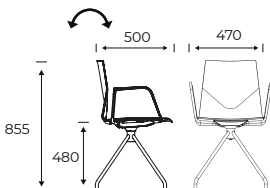
[Content ↗](#)

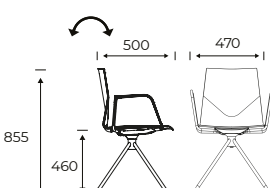
Design by Strand+Hvass

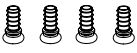
Product	Description (Item nr)	Weight (Kg)	Dimensions (mm)	Band	Veneer (SEK)	Optional PP (SEK)
	33141 FourCast® 2 One with Loop Armrests, Wooden shell, With tilt	5.9		-	5.873	5.873
	33143 FourCast® 2 One with Loop Armrests, Wooden shell, With tilt with return	6.1		-	7.046	7.046
	33151 FourCast® 2 One with Loop Armrests, Seat pad, wooden shell, With tilt	6.9		1 2 3 4 5 6 7 8 10	7.135 7.230 7.325 7.419 7.511 7.607 7.702 7.796 8.014	7.135 7.230 7.325 7.419 7.511 7.607 7.702 7.796 8.014
	33153 FourCast® 2 One with Loop Armrests, Seat pad, wooden shell, With tilt with return	7.1		1 2 3 4 5 6 7 8 10	8.308 8.403 8.498 8.592 8.684 8.780 8.875 8.969 9.187	8.308 8.403 8.498 8.592 8.684 8.780 8.875 8.969 9.187

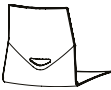
ACCESSORIES	Description	Weight (Kg)	Dimensions (mm)	Price (SEK)
	CHAIR FEET Castors			876
	CHAIR FEET Felt glides, set of 4 pcs. height + 0,2 cm	1,82 g x 4		208
	CHAIR FEET Set of 4 pcs. Noise reducing ferrule with big diameter (reduces pressure marks) Chair height + 0,8 cm	4,8 g x 4		276
	CHAIR FEET Noise reducing ferrule with felt, set of 4 pcs. Chair height +1 cm	6,6 g x 4		276
	CHAIR FEET Teflon glides, set of 4 pcs. Chair height + 0,2 cm	2,75 g x 4		208
	GRIP HOLE Available for chairs without inside - and full upholstery			189

FourCast® 2 Fire Retardant

Design by Strand+Hvass

[Content ↗](#)



FEATURES

- Shell in Polypropylene
- Polyamide glides are standard
- Linking device optional for model 33200 only
- Stackable on matching trollies

For product information visit fourdesign.dk ↗

SHELL COLOURS

Standard Polypropylene







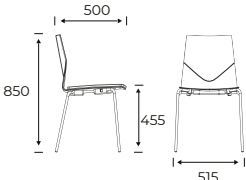

FRAME COLOURS

Standard

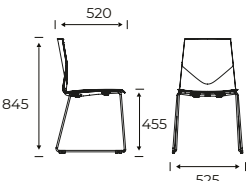

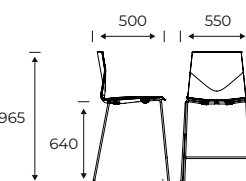

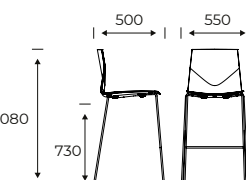





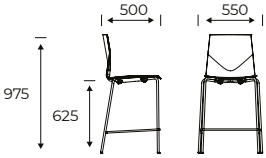

For full colour details [go to page 156](#) ↗

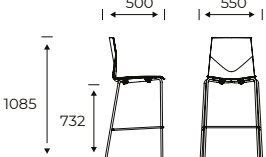
Product	Description (Item nr)	Weight (Kg)	Stacking on floor	Dimensions (mm)	Band	Standard PP (SEK)
	32500 FourCast@ 2 Four, Polypropylene shell	4.8	-		-	2.944
	33200 FourCast@ 2 Line, Polypropylene shell	5.7	-		-	3.430
	33800 FourCast@ 2 Counter, Polypropylene shell	6.6	-		-	4.384
	33900 FourCast@ 2 High, Polypropylene shell	7.3	-		-	4.469

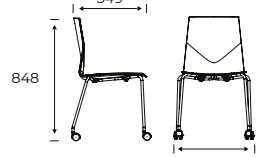
FourCast® 2 Fire Retardant

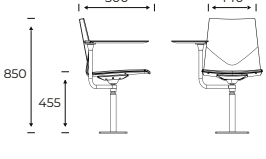
[Content ↗](#)

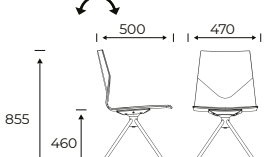







Design by Strand+Hvass

Product	Description (Item nr)	Weight (Kg)	Stacking on floor	Dimensions (mm)	Band	Standard PP (SEK)
	34000 FourCast@ 2 Counter Four, Polypropylene shell	7.7	-		-	4.146
	34100 FourCast@ 2 High Four, Polypropylene shell	6.7	-		-	4.146
	32800 FourCast@ 2 77, Polypropylene shell	5.8	-		-	3.388
	37001 FourCast@ 2 Audi, Polypropylene shell, With tilt	11.8	-		-	8.334
	33001 FourCast@ 2 One, Polypropylene shell, With tilt	6.2	-		-	4.452
	34503 FourCast@ 2 Evo, Polypropylene shell, With tilt with return	7	-		-	7.092

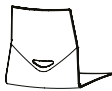
FourCast® 2 Fire Retardant

Design by Strand+Hvass

[Content ↗](#)

ACCESSORIES	Description	Weight (Kg)	Dimensions (mm)	Price (SEK)
	CHAIR FEET Felt glides, set of 4 pcs. height + 0,2 cm	1,82 g x 4		208
	CHAIR FEET Set of 4 pcs. Noise reducing ferrule with big diameter (reduces pressure marks) Chair height + 0,8 cm	4,8 g x 4		276
	CHAIR FEET Noise reducing ferrule with felt, set of 4 pcs. Chair height + 1 cm	6,6 g x 4		276
	CHAIR FEET Teflon glides, set of 4 pcs. Chair height + 0,2 cm	2,75 g x 4		208
	LINKING DEVICE Chair linking		C/C 540 mm C/C with armrest 540 mm	390
	GRIP HOLE Available for chairs without inside – and full upholstery			189
	SEAT ROW NUMBER - ACSR0101 16 mm - no. 1 -25	29 g		1.579
	SEAT ROW NUMBER - ACSR0102 16 mm - no. 26 -50	29 g		1.579
	SEAT ROW NUMBER - ACSR0201 11 mm - no. 1 -25	29 g		1.579
	SEAT ROW NUMBER - ACSR0202 11 mm - no. 26 -50	29 g		1.579
	CHAIR TROLLEY - 200X0 25 chairs without upholstery	33,5 Kg	1100 x 560 x 1970 mm	8.859
	INNO@NOTE TROLLEY - 20100007 Trolley for Inno® Note. Room for 51 Inno® Notes.	58,5 Kg	1532 x 662 x 1199 mm	19.942



FEATURES

- Wooden legs options
- Polyamide glides as standard
- Powder coated frame options

For product information visit fourdesign.dk ↗

SHELL COLOURS

Standard Polypropylene



FRAME COLOURS







Standard



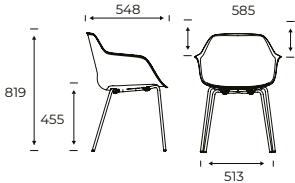

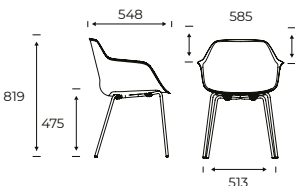

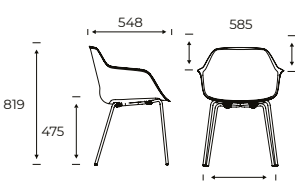

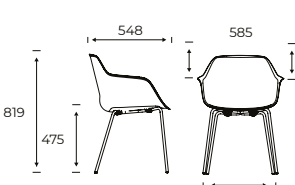

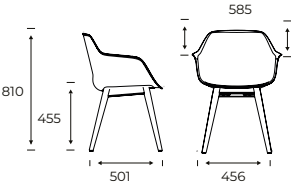

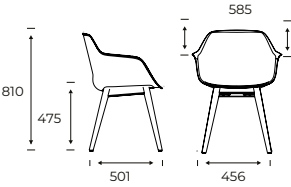
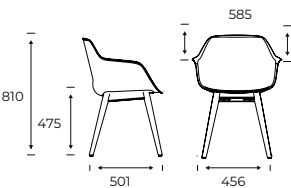
Frame optional*

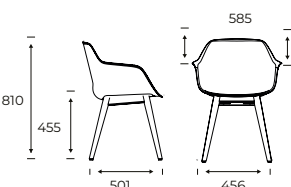

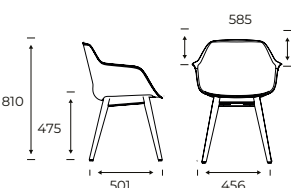

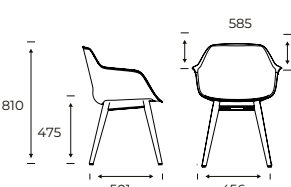
For full colour details [go to page 156](#) ↗

Product	Description (Item nr)	Weight (Kg)	Dimensions (mm)	Band	Standard PP (SEK)
	43000 FourMe® 44, Polypropylene shell	4.9		-	2.526
	43010 FourMe® 44, Seat pad	5.7		1 2 3 4 5 6 7 8 10	3.788 3.883 3.978 4.072 4.164 4.260 4.355 4.449 4.667
	43020 FourMe® 44, Inside upholstery	5.3		1 2 3 4 5 6 7 8 10	5.214 5.563 5.910 6.259 6.609 6.958 7.306 7.653 8.351
	43030 FourMe® 44, Fully upholstered	5.4		1 2 3 4 5 6 7 8 10	5.989 6.434 6.875 7.320 7.763 8.205 8.648 9.091 9.978

Product	Description (Item nr)	Weight (Kg)	Dimensions (mm)	Band	Standard PP (SEK)
	43000 FourMe® 44, Polypropylene shell, Oak oil, nature	4.9		-	3.778
	43010 FourMe® 44, Seat pad, Oak oil, nature	5.7		1 2 3 4 5 6 7 8 10	5.040 5.135 5.230 5.324 5.416 5.512 5.607 5.701 5.919
	43020 FourMe® 44, Inside upholstery, Oak oil, nature	5.3		1 2 3 4 5 6 7 8 10	6.466 6.815 7.162 7.511 7.861 8.210 8.558 8.905 9.603
	43030 FourMe® 44, Fully upholstered, Oak oil, nature	5.4		1 2 3 4 5 6 7 8 10	7.241 7.686 8.127 8.572 9.015 9.457 9.900 10.343 11.230
	43000 FourMe® 44, Polypropylene shell, Oak lacquered	4.9		-	4.149
	43010 FourMe® 44, Seat pad, Oak lacquered	5.7		1 2 3 4 5 6 7 8 10	5.411 5.506 5.601 5.695 5.787 5.883 5.978 6.072 6.290
	43020 FourMe® 44, Inside upholstery, Oak lacquered	5.3		1 2 3 4 5 6 7 8 10	6.837 7.186 7.533 7.882 8.232 8.581 8.929 9.276 9.974
	43030 FourMe® 44, Fully upholstered, Oak lacquered	5.4		1 2 3 4 5 6 7 8 10	7.612 8.057 8.498 8.943 9.386 9.828 10.271 10.714 11.601

Product	Description (Item nr)	Weight (Kg)	Dimensions (mm)	Band	Standard PP (SEK)
	4904 Loose seat pad (Only available for chairs without upholstery)	4.1		1	1.465
				2	1.561
				3	1.657
				4	1.753
				5	1.851
				6	1.947
				7	2.042
				8	2.138
				10	2.360

ACCESSORIES	Description	Weight (Kg)	Dimensions (mm)	Price (SEK)
	CHAIR FEET Felt glides, set of 4 pcs. height + 0,2 cm	1,82 g x 4		208
	CHAIR FEET Set of 4 pcs. Noise reducing ferrule with big diameter (reduces pressure marks) Chair height + 0,8 cm	4,8 g x 4		276
	CHAIR FEET Noise reducing ferrule with felt, set of 4 pcs. Chair height + 1 cm	6,6 g x 4		276
	CHAIR FEET Teflon glides, set of 4 pcs. Chair height + 0,2 cm	2,75 g x 4		208

SURCHARGE		Price (SEK)
FRAME OPTIONAL	 P	443
	 V	446



FEATURES

- Polyamide glides as standard
- Powder coated frame options

For product information visit fourdesign.dk ↗

SHELL COLOURS

Standard Polypropylene



FRAME COLOURS

Standard



For full colour details [go to page 156](#) ↗

Product	Description (Item nr)	Weight (Kg)	Dimensions (mm)	Band	Standard PP (SEK)
	43200 FourMe® 88, Polypropylene shell	5.9		-	2.982
	43210 FourMe® 88, Seat pad	6.7		1 2 3 4 5 6 7 8 10	4.244 4.339 4.434 4.528 4.620 4.716 4.811 4.905 5.123
	43220 FourMe® 88, Inside upholstery	6.3		1 2 3 4 5 6 7 8 10	5.670 6.019 6.366 6.715 7.065 7.414 7.762 8.109 8.807
	43230 FourMe® 88, Fully upholstered	6.4		1 2 3 4 5 6 7 8 10	6.445 6.890 7.331 7.776 8.219 8.661 9.104 9.547 10.434

Product	Description (Item nr)	Weight (Kg)	Dimensions (mm)	Band	Standard PP (SEK)
	4904 Loose seat pad (Only available for chairs without upholstery)	4.1		1	1.465
				2	1.561
				3	1.657
				4	1.753
				5	1.851
				6	1.947
				7	2.042
				8	2.138
				10	2.360

ACCESSORIES	Description	Weight (Kg)	Dimensions (mm)	Price (SEK)
	CHAIR FEET Felt glides, set of 4 pcs. height + 0,2 cm	1,82 g x 4		208
	CHAIR FEET Teflon glides, set of 4 pcs. Chair height + 0,2 cm	2,75 g x 4		208



FEATURES

- Inno® Tab, flexible and rotating writing tablet
- Gas lift, 41-57,5 cm
- Black base with castors as standard
- Aluminium base options

For product information visit fourdesign.dk ↗

SHELL COLOURS

Standard Polypropylene



FRAME COLOURS

Standard









Frame optional*

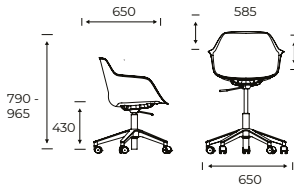

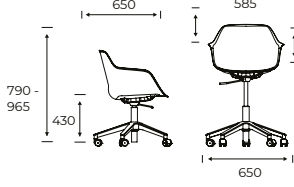
For full colour details [go to page 156](#) ↗

Product	Description (Item nr)	Weight (Kg)	Dimensions (mm)	Band	Standard PP (SEK)
	43404 FourMe® 66, Polypropylene shell, Without tilt with gas	7.5		-	3.283
	43405 FourMe® 66, Polypropylene shell, With tilt with gas	7.5		-	3.647
	43414 FourMe® 66, Seat pad, Without tilt with gas	8.4		1 2 3 4 5 6 7 8 10	4.545 4.640 4.735 4.829 4.921 5.017 5.112 5.206 5.424
	43415 FourMe® 66, Seat pad, With tilt with gas	8.4		1 2 3 4 5 6 7 8 10	4.909 5.004 5.099 5.193 5.285 5.381 5.476 5.570 5.788

Product	Description (Item nr)	Weight (Kg)	Dimensions (mm)	Band	Standard PP (SEK)
	43424 FourMe® 66, Inside upholstery, Without tilt with gas	7.9		1	5.971
				2	6.320
				3	6.667
				4	7.016
				5	7.366
				6	7.715
				7	8.063
				8	8.410
				10	9.108
					43425 FourMe® 66, Inside upholstery, With tilt with gas
2	6.684				
3	7.031				
4	7.380				
5	7.730				
6	8.079				
7	8.427				
8	8.774				
10	9.472				
	43434 FourMe® 66, Fully upholstered, Without tilt with gas	8.1			
				2	7.191
				3	7.632
				4	8.077
				5	8.520
				6	8.962
				7	9.405
				8	9.848
				10	10.735
					43435 FourMe® 66, Fully upholstered, With tilt with gas
2	7.555				
3	7.996				
4	8.441				
5	8.884				
6	9.326				
7	9.769				
8	10.212				
10	11.099				
	4904 Loose seat pad (Only available for chairs without upholstery)	4.1			
				2	1.561
				3	1.657
				4	1.753
				5	1.851
				6	1.947
				7	2.042
				8	2.138
				10	2.360

ACCESSORIES	Description	Weight (Kg)	Dimensions (mm)	Price (SEK)
	FOOTRING Gas lift including footring Spand 41 cm. - 57,5 cm.		585 - 845 mm	1.368
	With GS certification			1.489
	INNO Foldable Inno® Tab in black with integrated cup holder and dashboard for tablet and phone.	2,7 KG	520 x 320 x 230 mm	2.125

SURCHARGE		Price (SEK)
FRAME OPTIONAL 	4	643



FEATURES

- Excellent seating comfort
- Stackable + Stackable on matching trolley
- Always supplied with armrests

For product information visit fourdesign.dk ↗

FRAME COLOURS

Standard





Frame optional*

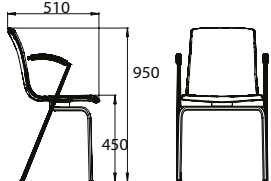

For full colour details [go to page 156](#) ↗

Product	Description (Item nr)	Weight (Kg)	Dimensions (mm)	Band	Standard (SEK)
	10501 G2	-		1 2 3 4 5 6 7 8 10	6.039 6.449 6.859 7.271 7.681 8.090 8.502 8.912 10.290

ACCESSORIES	Description	Weight (Kg)	Dimensions (mm)	Price (SEK)
	CHAIR FEET Felt glides, set of 4 pcs. height + 0,2 cm	1,82 g x 4		208
	SACK TROLLEY - 200X1 Trolley for 10 chairs. Stacking height incl. 4 chairs 114 cm. Additional chair + 10 cm.			4.918

SURCHARGE		Price (SEK)
FRAME OPTIONAL	 5	592
	 6	89

Four® Stool with Steel Legs

[Content ↗](#)

Design by Strand+Hvass



FEATURES

- PE glides are standard
- Upholstery options
- Seat in black lacquered oak options
- Available in 3 heights
- Powder coated frame options
- We do not recommend suspensions to fully upholstered and black lacquered versions

For product information visit fourdesign.dk ↗

SHELL COLOURS

Veneer



FRAME COLOURS







Standard

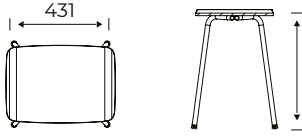

Optional Seat

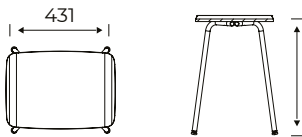

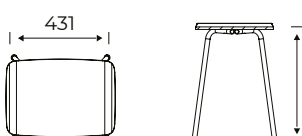

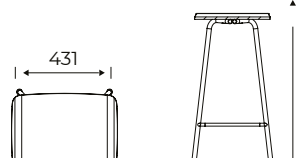



For full colour details [go to page 156](#) ↗

Product	Description (Item nr)	Weight (Kg)	Dimensions (mm)	Band	Veneer (SEK)	Optional veneer (SEK)
	64040 Four® Stool with Steel Legs, Wooden shell, Tableheight 74	2.4		-	2.094	2.539
	64050 Four® Stool with Steel Legs, Seat pad, wooden shell, Tableheight 74	2.7		1 2 3 4 5 6 7 8 10	2.980 3.073 3.167 3.259 3.351 3.443 3.538 3.630 3.730	3.425 3.518 3.612 3.704 3.796 3.888 3.983 4.075 4.175
	64030 Four® Stool with Steel Legs, Fully upholstered, Tableheight 74	2.6		1 2 3 4 5 6 7 8 10	3.341 3.434 3.526 3.619 3.714 3.807 3.899 3.993 4.208	
	64041 Four® Stool with Steel Legs, Wooden shell, Tableheight 90	4		-	2.498	2.943

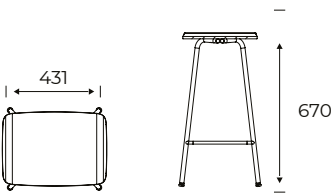
Four® Stool with Steel Legs

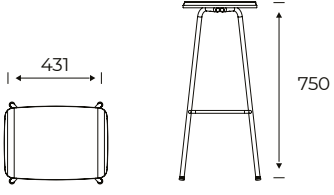
[Content ↗](#)

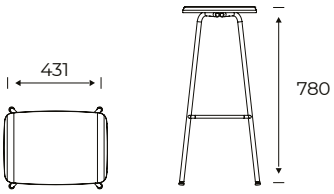
Design by Strand+Hvass

Product	Description (Item nr)	Weight (Kg)	Dimensions (mm)	Band	Veneer (SEK)	Optional veneer (SEK)
	64051 Four® Stool with Steel Legs, Seat pad, wooden shell, Tableheight 90	4.3		1	3.527	3.972
				2	3.621	4.066
				3	3.710	4.155
				4	3.810	4.255
				5	3.900	4.345
				6	3.994	4.439
				7	4.086	4.531
				8	4.179	4.624
				10	4.398	4.843
					64031 Four® Stool with Steel Legs, Fully upholstered, Tableheight 90	4.1
2	3.984					
3	4.077					
4	4.169					
5	4.263					
6	4.355					
7	4.448					
8	4.542					
10	4.759					
	64042 Four® Stool with Steel Legs, Wooden shell, Tableheight 105	4.3				
	64052 Four® Stool with Steel Legs, Seat pad, wooden shell, Tableheight 105	4.6		1	4.071	4.516
				2	4.165	4.610
				3	4.258	4.703
				4	4.350	4.795
				5	4.443	4.888
				6	4.537	4.982
				7	4.630	5.075
				8	4.723	5.168
				10	4.940	5.385
					64032 Four® Stool with Steel Legs, Fully upholstered, Tableheight 105	4.5
2	4.525					
3	4.620					
4	4.712					
5	4.807					
6	4.897					
7	4.991					
8	5.085					
10	5.300					

ACCESSORIES	Description	Weight (Kg)	Dimensions (mm)	Price (SEK)
	CHAIR FEET Felt glides, set of 4 pcs. height + 0,2 cm	1,82 g x 4		208

Four® Stool with Wooden Legs

[Content](#) ↗

Design by Strand+Hvass



FEATURES

- PE glides are standard
- Upholstery options
- Seat in black lacquered oak options
- Frame in black lacquered oak options
- Available in 3 heights
- We do not recommend suspensions to fully upholstered and black lacquered versions

For product information visit fourdesign.dk ↗

SHELL COLOURS

Veneer



31

Optional Seat



32

FRAME COLOURS

Standard









U

Frame optional*

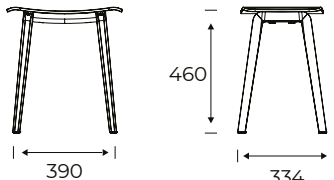

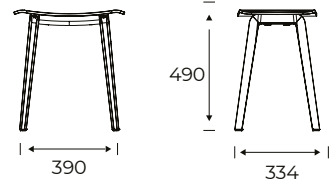
V

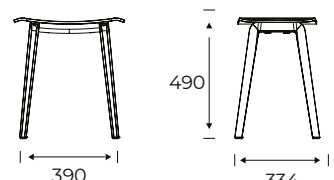

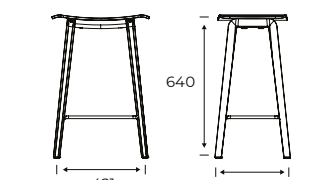





For full colour details [go to page 156](#) ↗

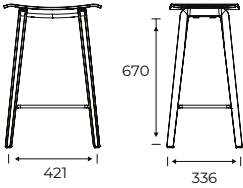

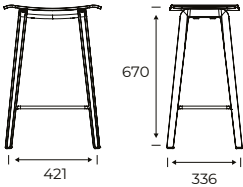

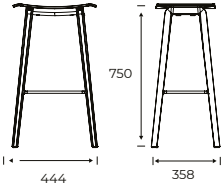
Product	Description (Item nr)	Weight (Kg)	Dimensions (mm)	Band	Veneer (SEK)	Optional veneer (SEK)
	63640 Four® Stool with Wooden Legs, Wooden shell, Tableheight 74	2.1		-	3.478	3.923
	63650 Four® Stool with Wooden Legs, Seat pad, wooden shell, Tableheight 74	2.4		1 2 3 4 5 6 7 8 10	4.614 4.704 4.793 4.882 4.973 5.062 5.151 5.241 5.450	5.059 5.149 5.238 5.327 5.418 5.507 5.596 5.686 5.895
	63630 Four® Stool with Wooden Legs, Fully upholstered, Tableheight 74	2.3		1 2 3 4 5 6 7 8 10	4.963 5.052 5.141 5.232 5.320 5.410 5.501 5.589 5.799	
	63641 Four® Stool with Wooden Legs, Wooden shell, Tableheight 90	3.5		-	4.872	5.317

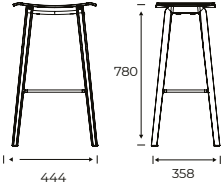
Four® Stool with Wooden Legs

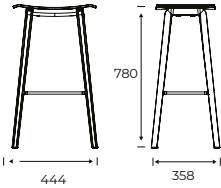
[Content ↗](#)

Design by Strand+Hvass

Product	Description (Item nr)	Weight (Kg)	Dimensions (mm)	Band	Veneer (SEK)	Optional veneer (SEK)
	63651 Four® Stool with Wooden Legs, Seat pad, wooden shell, Tableheight 90	3.8		1 2 3 4 5 6 7 8 10	6.008 6.098 6.186 6.276 6.366 6.456 6.544 6.635 6.844	6.453 6.543 6.631 6.721 6.811 6.901 6.989 7.080 7.289
	63631 Four® Stool with Wooden Legs, Fully upholstered, Tableheight 90	3.7		1 2 3 4 5 6 7 8 10	6.357 6.445 6.536 6.626 6.715 6.805 6.894 6.984 7.193	
	63642 Four® Stool with Wooden Legs, Wooden shell, Tableheight 105	3.8		-	4.899	5.344
	63652 Four® Stool with Wooden Legs, Seat pad, wooden shell, Tableheight 105	4.1		1 2 3 4 5 6 7 8 10	6.035 6.124 6.214 6.303 6.394 6.482 6.572 6.662 6.871	6.480 6.569 6.659 6.748 6.839 6.927 7.017 7.107 7.316
	63632 Four® Stool with Wooden Legs, Fully upholstered, Tableheight 105	3.9		1 2 3 4 5 6 7 8 10	6.383 6.473 6.563 6.651 6.740 6.832 6.922 7.010 7.221	

ACCESSORIES	Description	Weight (Kg)	Dimensions (mm)	Price (SEK)
	FOOT REST COLOUR Chrome			
	FOOT REST COLOUR Black matt standard Ral 7021			
	FOOT REST COLOUR White matt standard Ral 9010			
	FOOT REST COLOUR Stonegrey matt standard Ral 7039			

Four® Stool with Wooden Legs

[Content ↗](#)

Design by Strand+Hvass

SURCHARGE		Price (SEK)
FRAME OPTIONAL	<input checked="" type="checkbox"/> V	445

Four® Seating Bench with Steel Legs

[Content ↗](#)

Design by Strand+Hvass



FEATURES

- PE glides are standard
- Upholstery options
- Seat in black lacquered oak options
- Available in 3 lengths
- We do not recommend suspensions to Four Seating Benches

For product information visit fourdesign.dk ↗

SHELL COLOURS

Veneer



FRAME COLOURS







Standard

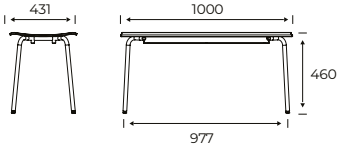

Optional Seat

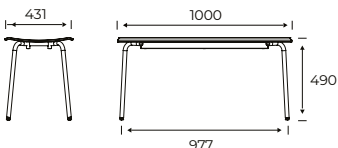

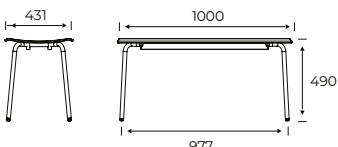

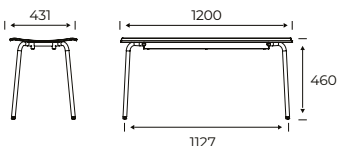



For full colour details [go to page 156](#) ↗

Product	Description (Item nr)	Weight (Kg)	Dimensions (mm)	Band	Standard PP (SEK)	Optional PP (SEK)
	64341 Four® Seating Bench with Steel Legs, Wooden shell, 1000 mm	6.2		-	3.718	4.163
	64351 Four® Seating Bench with Steel Legs, Seat pad, wooden shell, 1000 mm	7.1		1 2 3 4 5 6 7 8 10	5.874 6.148 6.423 6.696 6.971 7.244 7.519 7.794 8.370	6.319 6.593 6.868 7.141 7.416 7.689 7.964 8.239 8.815
	64331 Four® Seating Bench with Steel Legs, Fully upholstered, 1000 mm	6.8		1 2 3 4 5 6 7 8 10	6.539 6.813 7.088 7.361 7.634 7.907 8.183 8.456 9.032	
	64342 Four® Seating Bench with Steel Legs, Wooden shell, 1200 mm	7		-	3.984	4.429

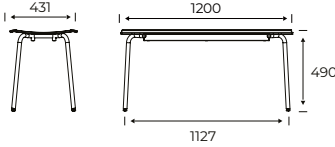
Four® Seating Bench with Steel Legs

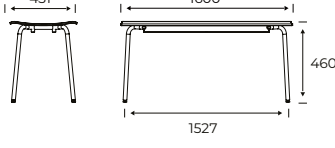
[Content ↗](#)

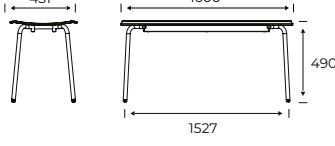
Design by Strand+Hvass

Product	Description (Item nr)	Weight (Kg)	Dimensions (mm)	Band	Standard PP (SEK)	Optional PP (SEK)
	64352 Four® Seating Bench with Steel Legs, Seat pad, wooden shell, 1200 mm	8.1		1	6.265	6.710
				2	6.663	7.108
				3	7.062	7.507
				4	7.460	7.905
				5	7.859	8.304
				6	8.257	8.702
				7	8.655	9.100
				8	9.053	9.498
				10	9.755	10.200
					64332 Four® Seating Bench with Steel Legs, Fully upholstered, 1200 mm	7.6
2	7.327					
3	7.726					
4	8.124					
5	8.523					
6	8.921					
7	9.319					
8	9.717					
10	10.420					
	64343 Four® Seating Bench with Steel Legs, Wooden shell, 1600 mm	5.1				
	64353 Four® Seating Bench with Steel Legs, Seat pad, wooden shell, 1600 mm	6.5		1	7.884	8.329
				2	8.571	9.016
				3	9.261	9.706
				4	9.949	10.394
				5	10.639	11.084
				6	11.327	11.772
				7	12.015	12.460
				8	12.705	13.150
				10	13.697	14.142
					64333 Four® Seating Bench with Steel Legs, Fully upholstered, 1600 mm	5.9
2	7.907					
3	8.597					
4	9.286					
5	9.975					
6	10.663					
7	11.352					
8	12.041					
10	13.034					

ACCESSORIES	Description	Weight (Kg)	Dimensions (mm)	Price (SEK)
	CHAIR FEET Felt glides, set of 4 pcs. height + 0,2 cm	1,82 g x 4		208

Four® Seating Bench with Wooden Legs

[Content ↗](#)

Design by Strand+Hvass



FEATURES

- PE glides are standard
- Upholstery options
- Seat in black lacquered oak options
- Frame in black lacquered oak options
- Available in 3 lengths
- We do not recommend suspensions to Four Seating Benches

For product information visit fourdesign.dk ↗

SHELL COLOURS

Veneer



31



32

FRAME COLOURS

Standard



U



V

Optional Seat

Frame optional*



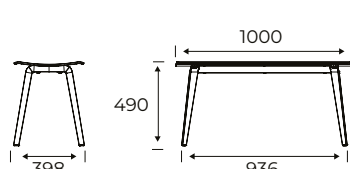
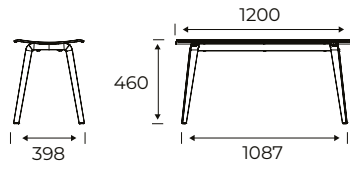



For full colour details [go to page 156](#) ↗

Product	Description (Item nr)	Weight (Kg)	Dimensions (mm)	Band	Veneer (SEK)	Optional veneer (SEK)
	63341 Four® Seating Bench with Wooden Legs, Wooden shell, 1000 mm	6.1		-	7.460	7.905
	63351 Four® Seating Bench with Wooden Legs, Seat pad, wooden shell, 1000 mm	7		1 2 3 4 5 6 7 8 10	9.617 9.891 10.166 10.440 10.714 10.987 11.260 11.535 12.112	10.062 10.336 10.611 10.885 11.159 11.432 11.705 11.980 12.557
	63331 Four® Seating Bench with Wooden Legs, Fully upholstered, 1000 mm	6.6		1 2 3 4 5 6 7 8 10	10.283 10.554 10.828 11.103 11.377 11.651 11.924 12.200 12.776	
	63342 Four® Seating Bench with Wooden Legs, Wooden shell, 1200 mm	6.9		-	7.959	8.404

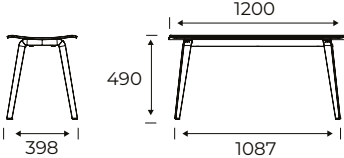
Four® Seating Bench with Wooden Legs

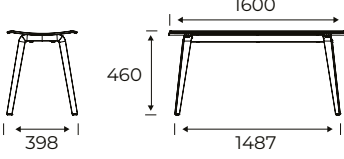
[Content ↗](#)

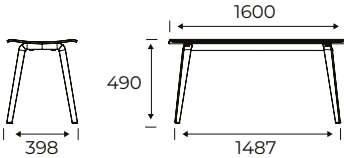
Design by Strand+Hvass

Product	Description (Item nr)	Weight (Kg)	Dimensions (mm)	Band	Veneer (SEK)	Optional veneer (SEK)
	63352 Four® Seating Bench with Wooden Legs, Seat pad, wooden shell, 1200 mm	7.9		1	10.241	10.686
				2	10.639	11.084
				3	11.037	11.482
				4	11.435	11.880
				5	11.834	12.279
				6	12.232	12.677
				7	12.631	13.076
				8	13.029	13.474
				10	13.730	14.175
					63332 Four® Seating Bench with Wooden Legs, Fully upholstered, 1200 mm	7.5
2	11.302					
3	11.703					
4	12.100					
5	12.498					
6	12.896					
7	13.294					
8	13.692					
10	14.395					
	63343 Four® Seating Bench with Wooden Legs, Wooden shell, 1600 mm	8.8				
	63353 Four® Seating Bench with Wooden Legs, Seat pad, wooden shell, 1600 mm	10.2		1	11.027	11.472
				2	11.717	12.162
				3	12.407	12.852
				4	13.095	13.540
				5	13.782	14.227
				6	14.472	14.917
				7	15.162	15.607
				8	15.850	16.295
				10	16.842	17.287
					63333 Four® Seating Bench with Wooden Legs, Fully upholstered, 1600 mm	9.6
2	12.381					
3	13.070					
4	13.759					
5	14.448					
6	15.135					
7	15.825					
8	16.514					
10	17.505					

SURCHARGE		Price (SEK)
FRAME OPTIONAL	● V	445







FEATURES

- CMHR foam

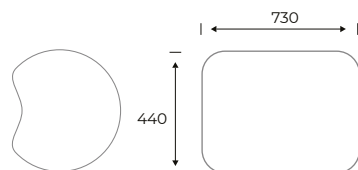
For product information visit fourdesign.dk ↗

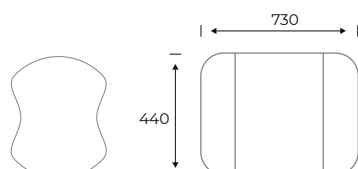
For full colour details [go to page 156](#) ↗

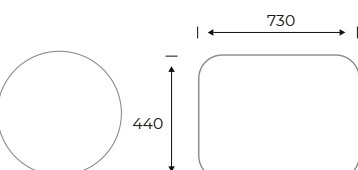
Product	Description (Item nr)	Weight (Kg)	Dimensions (mm)	Band	Standard (SEK)														
	CASINOCA1 Casino CAS1C, CAS1C	-		<table border="1"> <tr><td>1</td><td>3.787</td></tr> <tr><td>2</td><td>4.234</td></tr> <tr><td>3</td><td>4.646</td></tr> <tr><td>4</td><td>5.442</td></tr> <tr><td>5</td><td>6.510</td></tr> <tr><td>6</td><td>8.127</td></tr> <tr><td>7</td><td>9.794</td></tr> </table>	1	3.787	2	4.234	3	4.646	4	5.442	5	6.510	6	8.127	7	9.794	
1	3.787																		
2	4.234																		
3	4.646																		
4	5.442																		
5	6.510																		
6	8.127																		
7	9.794																		
	CASINOCA2 Casino CAS2C, CAS2C	-		<table border="1"> <tr><td>1</td><td>3.787</td></tr> <tr><td>2</td><td>4.234</td></tr> <tr><td>3</td><td>4.646</td></tr> <tr><td>4</td><td>5.442</td></tr> <tr><td>5</td><td>6.510</td></tr> <tr><td>6</td><td>8.127</td></tr> <tr><td>7</td><td>9.794</td></tr> </table>	1	3.787	2	4.234	3	4.646	4	5.442	5	6.510	6	8.127	7	9.794	
1	3.787																		
2	4.234																		
3	4.646																		
4	5.442																		
5	6.510																		
6	8.127																		
7	9.794																		
	CASINOCAC Casino CASCIRC, CASCIRC	-		<table border="1"> <tr><td>1</td><td>3.787</td></tr> <tr><td>2</td><td>4.234</td></tr> <tr><td>3</td><td>4.646</td></tr> <tr><td>4</td><td>5.442</td></tr> <tr><td>5</td><td>6.510</td></tr> <tr><td>6</td><td>8.127</td></tr> <tr><td>7</td><td>9.794</td></tr> </table>	1	3.787	2	4.234	3	4.646	4	5.442	5	6.510	6	8.127	7	9.794	
1	3.787																		
2	4.234																		
3	4.646																		
4	5.442																		
5	6.510																		
6	8.127																		
7	9.794																		

FourReal® 74 with Angled Legs

[Content](#) ↗

Design by Studio Ocee



FEATURES

- Table height 74 cm. Angled legs - integrated castors on two legs.
- With height adjustment glides on the other two legs to aid movement
- Foldable by one person without the use of tools. Matching ABS edges.
- Room In Room & Chair suspension options. Room In Room comes in Decor as standard.
- Electrical units are optional and will be positioned in the centre of tables as standard.

For product information visit fourdesign.dk ↗

TABLE TOP

Decor



Laminate



Fenix laminate



Linoleum



FRAME COLOURS

Standard











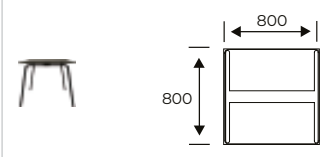

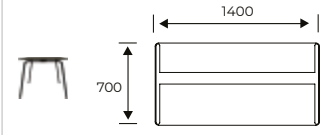

Frame optional*

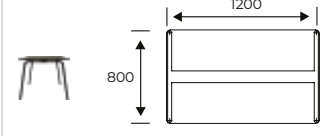

For electrical accessories [go to page 148](#) ↗

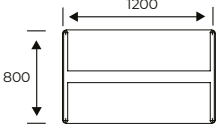
For full colour details [go to page 156](#) ↗

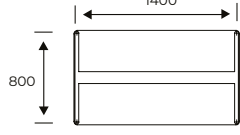







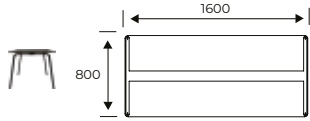

Product	Description (Item nr)	Weight (Kg)	Chair suspension	Dimensions (mm)	Top/Band	Price (SEK)
	21980 FourReal® 74 with Angled Legs, 80 x 80, Folding legs	19.5	2	 	Decor Laminate Fenix laminate Linoleum	6.245 6.712 8.003 9.407
	21800 FourReal® 74L with Angled Legs, 128 x 64, Folding legs	21.4	2	 	Decor Laminate Fenix laminate Linoleum	6.525 7.377 9.195 11.021
	21810 FourReal® 74L with Angled Legs, 140 x 70, Folding legs	24.1	2	 	Decor Laminate Fenix laminate Linoleum	6.731 7.745 10.005 11.390
	21900 FourReal® 74 with Angled Legs, 120 x 80, Folding legs	24	4	 	Decor Laminate Fenix laminate Linoleum	6.615 7.628 9.781 11.146
	21910 FourReal® 74 with Angled Legs, 140 x 80, Folding legs	26.3	4	 	Decor Laminate Fenix laminate Linoleum	6.909 7.987 10.648 11.797

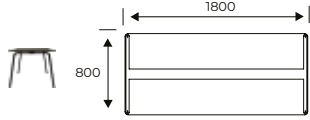
For tabletop cutout placements go to: [Fourdesign.dk/Cutout.pdf](https://fourdesign.dk/Cutout.pdf)

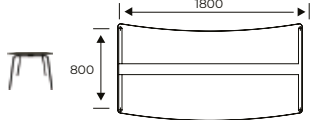
FourReal® 74 with Angled Legs

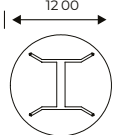
[Content ↗](#)

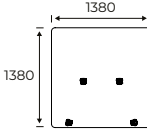
Design by Studio Ocee



Product	Description (Item nr)	Weight (Kg)	Chair suspension	Dimensions (mm)	Top/Band	Price (SEK)
	21950 FourReal® 74 with Angled Legs, 160 x 80, Folding legs	31.6	4		Decor	7.280
					Laminate	8.599
					Fenix laminate	11.765
					Linoleum	12.375
	21920 FourReal® 74 with Angled Legs, 180 x 80, Folding legs	31.5	6		Decor	7.481
					Laminate	8.930
					Fenix laminate	12.368
					Linoleum	12.684
	219A0 FourReal® 74 with Angled Legs, 180 x 80 curve, Folding legs	39.7	6		Decor	8.151
					Laminate	9.601
					Fenix laminate	13.593
					Linoleum	14.679
	21930 FourReal® 74 with Angled Legs, Ø120, Folding legs	27	2		Decor	7.247
					Laminate	8.532
					Fenix laminate	11.858
					Linoleum	13.373
	2421 Room in Room, FourReal® 74 with Angled Legs	26.3	-		Decor	3.502
					Laminate	
					Fenix laminate	
					Linoleum	
	2430000 Acoustic for RinR, 133 x 65	6.7	-		1	2.852
					2	3.065
					3	3.279
					4	3.503
					5	3.706
					6	3.909

[For tabletop cutout placements go to: Fourdesign.dk/Cutout.pdf](https://Fourdesign.dk/Cutout.pdf)

FourReal® 74 with Angled Legs

Design by Studio Ocee

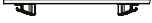
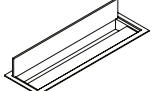
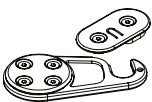
[Content ↗](#)

ACCESSORIES	Description	Weight (Kg)	Dimensions (mm)	Price (SEK)
	CHAIR SUSPENSION Chair suspension for FourCast2 Four, FourCast2 Line, FourSure 44, FourSure 88, FourSure 11, FourSure 99, Four Stools, Four Seating Benches	0,3 Kg		255
	CHAIR SUSPENSION Chair suspension for FourCast2 Wheeler, FourSure 66	0,3 Kg		255
	CABLE CUT OUT Cable duct, aluminum. Cable duct placed in apron			2.030
	CABLE CUT OUT			711
	LINKING DEVICE Linking Device, set of 4 pcs - 2 x he, 2 x she per table			525
	TABLE TROLLEY - 20100001 Trolley for 10 Folded Tables or 7 round tables, including strap	20 Kg	1720 mm x 550 mm x 980 mm. Folded Table: 150 mm	8.773
SURCHARGE				Price (SEK)
FRAME OPTIONAL	 6			382

FourReal® 74 with Straight Legs

[Content ↗](#)

Design by Studio Ocee



FEATURES

- Table height 74 cm. Straight legs – Integrated castors on two legs.
- With height adjustment glides on the other two legs to aid movement
- Foldable by one person without the use of tools. Matching ABS edges.
- Room In Room & Chair suspension options. Room In Room comes in Decor as standard.
- Electrical units are optional and will be positioned in the centre of tables as standard.

For product information visit fourdesign.dk ↗

TABLE TOP

Decor



Laminate



Fenix laminate



Linoleum



FRAME COLOURS

Standard









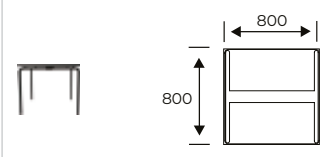

Frame optional*

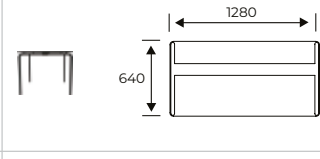

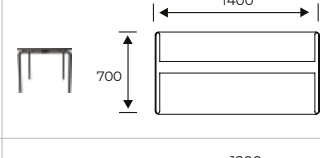
For electrical accessories [go to page 148](#) ↗

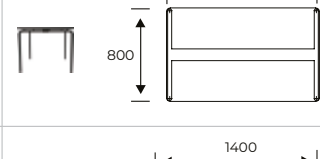
For full colour details [go to page 156](#) ↗

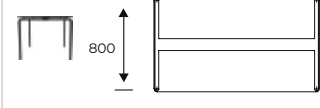







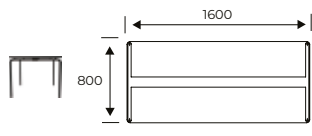

Product	Description (Item nr)	Weight (Kg)	Chair suspension	Dimensions (mm)	Top/Band	Price (SEK)
	22080 FourReal® 74 with Straight Legs, 80 x 80, Folding legs	20.2	2		Decor Laminate Fenix laminate Linoleum	6.245 6.712 8.003 9.407
	21600 FourReal® 74L with Straight Legs, 128 x 64, Folding legs	22	2		Decor Laminate Fenix laminate Linoleum	6.525 7.377 9.195 11.021
	21610 FourReal® 74L with Straight Legs, 140 x 70, Folding legs	24.7	2		Decor Laminate Fenix laminate Linoleum	6.731 7.745 10.005 11.390
	22000 FourReal® 74 with Straight Legs, 120 x 80, Folding legs	24.6	4		Decor Laminate Fenix laminate Linoleum	6.615 7.628 9.781 11.146
	22010 FourReal® 74 with Straight Legs, 140 x 80, Folding legs	26.9	4		Decor Laminate Fenix laminate Linoleum	6.909 7.987 10.648 11.797

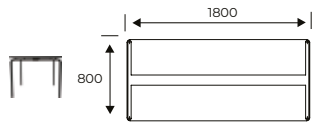
For tabletop cutout placements [go to: Fourdesign.dk/Cutout.pdf](http://Fourdesign.dk/Cutout.pdf)

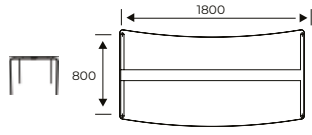
FourReal® 74 with Straight Legs

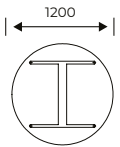
[Content ↗](#)

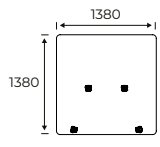
Design by Studio Ocee

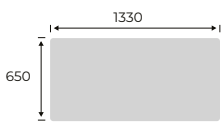



Product	Description (Item nr)	Weight (Kg)	Chair suspension	Dimensions (mm)	Top/Band	Price (SEK)
	22050 FourReal® 74 with Straight Legs, 160 x 80, Folding legs	32.2	4		Decor	7.280
					Laminate	8.599
					Fenix laminate	11.765
					Linoleum	12.375
	22020 FourReal® 74 with Straight Legs, 180 x 80, Folding legs	32.2	6		Decor	7.481
					Laminate	8.930
					Fenix laminate	12.368
					Linoleum	12.684
	220A0 FourReal® 74 with Straight Legs, 180 x 80 curve, Folding legs	-	6		Decor	8.151
					Laminate	9.601
					Fenix laminate	13.593
					Linoleum	14.679
	22030 FourReal® 74 with Straight Legs, Ø120, Folding legs	28.1	2		Decor	7.247
					Laminate	8.532
					Fenix laminate	11.858
					Linoleum	13.373
	2420 Room in Room, FourReal® 74 with Straight Legs	26.3	-		Decor	3.502
					Laminate	
					Fenix laminate	
					Linoleum	
	2430000 Acoustic for RinR, 133 x 65	6.7	-		1	2.852
					2	3.065
					3	3.279
					4	3.503
					5	3.706
					6	3.909

[For tabletop cutout placements go to: Fourdesign.dk/Cutout.pdf](http://Fourdesign.dk/Cutout.pdf)

FourReal® 74 with Straight Legs

Design by Studio Ocee

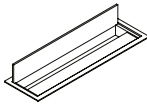
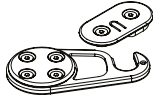
[Content ↗](#)

ACCESSORIES	Description	Weight (Kg)	Dimensions (mm)	Price (SEK)
	CHAIR SUSPENSION Chair suspension for FourCast2 Four, FourCast2 Line, FourSure 44, FourSure 88, FourSure 11, FourSure 99, Four Stools, Four Seating Benches	0,3 Kg		255
	CHAIR SUSPENSION Chair suspension for FourCast2 Wheeler, FourSure 66	0,3 Kg		255
	CABLE CUT OUT Cable duct, aluminum. Cable duct placed in apron			2.030
	CABLE CUT OUT			711
	LINKING DEVICE Linking Device, set of 4 pcs - 2 x he, 2 x she per table			525
	TABLE TROLLEY - 20100001 Trolley for 10 Folded Tables or 7 round tables, including strap	20 Kg	1720 mm x 550 mm x 980 mm. Folded Table: 150 mm	8.773
SURCHARGE				Price (SEK)
FRAME OPTIONAL	 6			382



FEATURES

- Table height 90 cm. Angled legs – Integrated castors on two legs.
- With height adjustment glides on the other two legs to aid movement.
- Foldable by one person without use of tools. Matching ABS edges.
- Room In Room & Chair suspension options. Room In Room comes in Decor as standard.
- Electrical units are optional and will be positioned in the centre of tables as standard.

For product information visit fourdesign.dk ↗

TABLE TOP

Decor



Laminate



Fenix laminate



Linoleum



FRAME COLOURS

Standard



Frame optional*







For electrical accessories [go to page 148](#) ↗

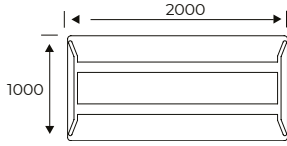

For full colour details [go to page 156](#) ↗

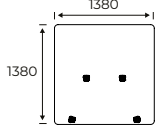
Product	Description (Item nr)	Weight (Kg)	Chair suspension	Dimensions (mm)	Top/Band	Price (SEK)
	22300 FourReal® 90, 140 x 60, Folding legs	25.1	0		Decor Laminate Fenix laminate Linoleum	7.326 8.440 10.510 11.423
	22310 FourReal® 90, 140 x 80, Folding legs	30.2	4		Decor Laminate Fenix laminate Linoleum	7.559 8.706 11.313 12.380
	22380 FourReal® 90, 160 x 80, Folding legs	30.5	4		Decor Laminate Fenix laminate Linoleum	7.941 9.147 12.744 13.578
	22320 FourReal® 90, 180 x 60, Folding legs	27.5	0		Decor Laminate Fenix laminate Linoleum	7.946 9.154 11.984 12.590
	22330 FourReal® 90, 180 x 80, Folding legs	33.1	6		Decor Laminate Fenix laminate Linoleum	8.150 9.384 13.515 14.221

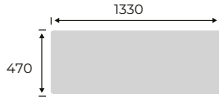
For tabletop cutout placements go to: [Fourdesign.dk/Cutout.pdf](https://fourdesign.dk/Cutout.pdf)

Product	Description (Item nr)	Weight (Kg)	Chair suspension	Dimensions (mm)	Top/Band	Price (SEK)
	22360 FourReal® 90, 200 x 100, Folding legs	51.4	0		Decor	11.280
					Laminate	13.214
					Fenix laminate	18.347
					Linoleum	19.810
	2423 Room in Room, FourReal 90	26.4	-		Decor	3.502
					Laminate	
					Fenix laminate	
					Linoleum	
	2430001 Acoustic for RinR, 133 x 47	4.8	-		1	2.852
					2	3.065
					3	3.279
					4	3.503
					5	3.706
					6	3.909

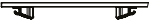
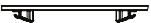
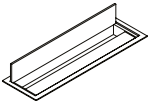
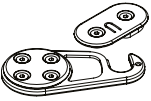
For tabletop cutout placements go to: Fourdesign.dk/Cutout.pdf

ACCESSORIES	Description	Weight (Kg)	Dimensions (mm)	Price (SEK)
	CHAIR SUSPENSION Chair suspension for FourCast2 Four, FourCast2 Line, FourSure 44, FourSure 88, FourSure 11, FourSure 99, Four Stools, Four Seating Benches	0,3 Kg		255
	CHAIR SUSPENSION Chair suspension for FourCast2 Wheeler, FourSure 66	0,3 Kg		255
	CABLE CUT OUT Cable duct, aluminum. Cable duct placed in apron			2.030
	CABLE CUT OUT			711
	LINKING DEVICE Linking Device, set of 4 pcs - 2 x he, 2 x she per table			525
	TABLE TROLLEY - 20100001 Trolley for 10 Folded Tables or 7 round tables, including strap	20 Kg	1720 mm x 550 mm x 980 mm. Folded Table: 150 mm	8.773
SURCHARGE				Price (SEK)
FRAME OPTIONAL	 6			382



FEATURES

- Table height 105 cm. Angled legs – Integrated castors on two legs.
- Foldable by one person without the use of tools. Matching ABS edges.
- Room In Room & Chair suspension options. Room In Room comes in Decor as standard.
- Electrical units are optional and will be positioned in the centre of tables as standard.

For product information visit fourdesign.dk ↗

TABLE TOP

Decor



Laminate



Fenix laminate



Linoleum



FRAME COLOURS

Standard



Frame optional*





For electrical accessories [go to page 148](#) ↗

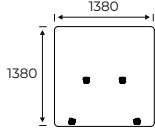

For full colour details [go to page 156](#) ↗

Product	Description (Item nr)	Weight (Kg)	Chair suspension	Dimensions (mm)	Top/Band	Price (SEK)
	22400 FourReal® 105, 140 x 60, Folding legs	26.1	0		Decor	7.323
					Laminate	8.440
					Fenix laminate	10.510
					Linoleum	11.423
	22410 FourReal® 105, 140 x 80, Folding legs	31.2	4		Decor	7.559
					Laminate	8.706
					Fenix laminate	11.313
					Linoleum	12.380
	22480 FourReal® 105, 160 x 80, Folding legs	31.5	4		Decor	7.941
					Laminate	9.147
					Fenix laminate	12.744
					Linoleum	13.578
	22420 FourReal® 105, 180 x 60, Folding legs	28.4	0		Decor	7.946
					Laminate	9.154
					Fenix laminate	11.984
					Linoleum	12.590
	22430 FourReal® 105, 180 x 80, Folding legs	34.2	6		Decor	8.150
					Laminate	9.384
					Fenix laminate	13.515
					Linoleum	14.266

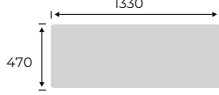
For tabletop cutout placements [go to: Fourdesign.dk/Cutout.pdf](https://fourdesign.dk/Cutout.pdf)

Product	Description (Item nr)	Weight (Kg)	Chair suspension	Dimensions (mm)	Top/Band	Price (SEK)
	2424 Room in Room, FourReal 105	26.4	-		Decor Laminate Fenix laminate Linoleum	3.502
	2430001 Acoustic for RinR, 133 x 47	4.8	-		1 2 3 4 5 6	2.852 3.065 3.279 3.503 3.706 3.909

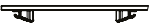
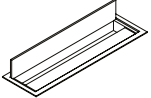
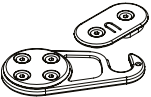
For tabletop cutout placements go to: Fourdesign.dk/Cutout.pdf

ACCESSORIES	Description	Weight (Kg)	Dimensions (mm)	Price (SEK)
	CHAIR SUSPENSION Chair suspension for FourCast2 Four, FourCast2 Line, FourSure 44, FourSure 88, FourSure 11, FourSure 99, Four Stools, Four Seating Benches	0,3 Kg		255
	CHAIR SUSPENSION Chair suspension for FourCast2 Wheeler, FourSure 66	0,3 Kg		255
	CABLE CUT OUT Cable duct, aluminum. Cable duct placed in apron			2.030
	CABLE CUT OUT			711
	LINKING DEVICE Linking Device, set of 4 pcs - 2 x he, 2 x she per table			525
	TABLE TROLLEY - 20100001 Trolley for 10 Folded Tables or 7 round tables, including strap	20 Kg	1720 mm x 550 mm x 980 mm. Folded Table: 150 mm	8.773

SURCHARGE		Price (SEK)
FRAME OPTIONAL	 6	382

FourReal® 741 Flake

Design by Studio Ocee

[Content ↗](#)



FEATURES

- Table height 74 cm. Angled legs – integrated castors on two legs
- With height adjustment glides on the other two legs to aid movement
- Foldable by one person without the use of tools. Matching ABS edges.
- Room In Room & Chair suspension options. Room In Room comes in Decor as standard.
- Powder coated frame options
- Electrical units are optional and will be positioned in the centre of tables as standard.

For product information visit fourdesign.dk ↗

TABLE TOP

Decor



Laminate



Fenix laminate



Linoleum



FRAME COLOURS

Standard



Frame optional*



For electrical accessories [go to page 148](#) ↗

For full colour details [go to page 156](#) ↗



Product	Description (Item nr)	Weight (Kg)	Chair suspension	Dimensions (mm)	Top/Band	Price (SEK)
	21700 FourReal® 741 Flake, 140 x 100, Folding legs	33.9	4		Decor Laminate Fenix laminate Linoleum	8.126 9.446 13.079 14.279
	21720 FourReal® 741 Flake, 200 x 100, Folding legs	50.3	0		Decor Laminate Fenix laminate Linoleum	11.082 12.999 18.146 19.612
	21750 FourReal® 741 Flake, 198 x 100 ellipse, Folding legs	37.1	4		Decor Laminate Fenix laminate Linoleum	10.814 12.682 17.703 19.119
	21760 FourReal® 741 Flake, 160 x 100 half ellipse, Folding legs	31.6	4		Decor Laminate Fenix laminate Linoleum	8.514 9.783 12.323 13.308
	21770 FourReal® 741 Flake, 140 x 129 Diamond, Folding legs	30.4	3		Decor Laminate Fenix laminate Linoleum	9.029 10.872 13.955 15.068

For tabletop cutout placements [go to: Fourdesign.dk/Cutout.pdf](https://fourdesign.dk/Cutout.pdf)

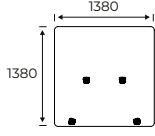

FourReal® 741 Flake

Design by Studio Ocee

[Content ↗](#)

Product	Description (Item nr)	Weight (Kg)	Chair suspension	Dimensions (mm)	Top/Band	Price (SEK)
	2422 Room in Room, FourReal 741	26.4	-		Decor Laminate Fenix laminate Linoleum	3.502
	2430000 Acoustic for RinR, 133 x 65	6.7	-		1 2 3 4 5 6	2.852 3.065 3.279 3.503 3.706 3.909

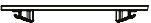
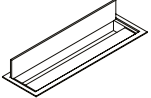
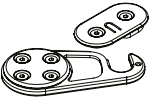
For tabletop cutout placements go to: Fourdesign.dk/Cutout.pdf

ACCESSORIES	Description	Weight (Kg)	Dimensions (mm)	Price (SEK)
	CHAIR SUSPENSION Chair suspension for FourCast2 Four, FourCast2 Line, FourSure 44, FourSure 88, FourSure 11, FourSure 99, Four Stools, Four Seating Benches	0,3 Kg		255
	CHAIR SUSPENSION Chair suspension for FourCast2 Wheeler, FourSure 66	0,3 Kg		255
	CABLE CUT OUT Cable duct, aluminum. Cable duct placed in apron			2.030
	CABLE CUT OUT			711
	LINKING DEVICE Linking Device, set of 4 pcs - 2 x he, 2 x she per table			525
	TABLE TROLLEY - 20100001 Trolley for 10 Folded Tables or 7 round tables, including strap	20 Kg	1720 mm x 550 mm x 980 mm. Folded Table: 150 mm	8.773

SURCHARGE		Price (SEK)
FRAME OPTIONAL	 6	382



FEATURES

- Table height 74 cm – integrated castors on two legs.
- Matching ABS edges.
- Chair suspension, Flower box & Top-shelf options.
- Powder coated frame options.
- Delivered unassembled.
- Electrical units are optional and will be positioned in the centre of tables as standard.

For product information visit fourdesign.dk ↗

TABLE TOP

Decor



04 05 06

Laminate



01 02 03

Fenix laminate



07 08 09

Linoleum



10

FRAME COLOURS

Standard









B C K

For electrical accessories [go to page 148](#) ↗

For full colour details [go to page 156](#) ↗

Product	Description (Item nr)	Weight (Kg)	Chair suspension	Dimensions (mm)	Top	Price (SEK)
	65025 FourReal® A 74, 140 x 80, A	44,1	4		Decor	9.130
					Laminate	9.961
					Fenix laminate	13.215
					Linoleum	14.753
	65015 FourReal® A 74, 180 x 80, A	52	6		Decor	9.713
					Laminate	10.921
					Fenix laminate	14.963
					Linoleum	15.652

For tabletop cutout placements go to: Fourdesign.dk/Cutout.pdf

ACCESSORIES	Description	Weight (Kg)	Dimensions (mm)	Price (SEK)
	CHAIR SUSPENSION Chair suspension for FourCast2 Four, FourCast2 Line, FourSure 44, FourSure 88, FourSure 11, FourSure 99, Four Stools, Four Seating Benches	0,3 Kg		255
	CHAIR SUSPENSION Chair suspension for FourCast2 Wheeler, FourSure 66	0,3 Kg		255
	699000008 Table Accessories, Flower box black, 60 cm	0,4 Kg	L600 x W160 x H140 mm	438
	699000005 Table Accessories, Flower box black, 80 cm	0,5 Kg	L800 x W160 x H140 mm	438
	699000001 Table Accessories, Top shelf white, 60 cm x 20,5 cm	1,5 Kg	600 x 205 mm	438
	699000002 Table Accessories, Top shelf black, 60 cm x 20,5 cm	1,5 Kg	600 x 205 mm	438
	699000003 Table Accessories, Top shelf grey, 60 cm x 20,5 cm	1,5 Kg	600 x 205 mm	438

FourReal® A 90

Design by Studio Ocee

[Content ↗](#)



FEATURES

- Table height 90 cm – integrated castors on two legs.
- Matching ABS edges.
- Chair suspension, Flower box & Top-shelf options.
- Powder coated frame options.
- Delivered unassembled.
- Electrical units are optional and will be positioned in the centre of tables as standard.

For product information visit fourdesign.dk ↗

TABLE TOP

Decor



Laminate



Fenix laminate



Linoleum



FRAME COLOURS

Standard

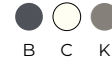







For electrical accessories [go to page 148](#) ↗

For full colour details [go to page 156](#) ↗

Product	Description (Item nr)	Weight (Kg)	Chair suspension	Dimensions (mm)	Top	Price (SEK)
	65125 FourReal® A 90, 140 x 80, A	43.8	4		Decor	9.130
					Laminate	9.961
					Fenix laminate	13.215
					Linoleum	14.753
	65115 FourReal® A 90, 180 x 80, A	51.7	6		Decor	9.713
					Laminate	10.921
					Fenix laminate	14.963
					Linoleum	15.652

For tabletop cutout placements go to: [Fourdesign.dk/Cutout.pdf](https://fourdesign.dk/Cutout.pdf)

ACCESSORIES	Description	Weight (Kg)	Dimensions (mm)	Price (SEK)
	CHAIR SUSPENSION Chair suspension for FourCast2 Four, FourCast2 Line, FourSure 44, FourSure 88, FourSure 11, FourSure 99, Four Stools, Four Seating Benches	0,3 Kg		255
	CHAIR SUSPENSION Chair suspension for FourCast2 Wheeler, FourSure 66	0,3 Kg		255
	699000008 Table Accessories, Flower box black, 60 cm	0,4 Kg	L600 x W160 x H140 mm	438
	699000005 Table Accessories, Flower box black, 80 cm	0,5 Kg	L800 x W160 x H140 mm	438
	699000001 Table Accessories, Top shelf white, 60 cm x 20,5 cm	1,5 Kg	600 x 205 mm	438
	699000002 Table Accessories, Top shelf black, 60 cm x 20,5 cm	1,5 Kg	600 x 205 mm	438
	699000003 Table Accessories, Top shelf grey, 60 cm x 20,5 cm	1,5 Kg	600 x 205 mm	438

FourReal® A XL 74

Design by Studio Ocee

[Content ↗](#)



FEATURES

- Table height 74 cm – integrated castors on two legs
- Matching ABS edges.
- Chair suspension, Flower box & Top-shelf options.
- Powder coated frame options.
- Delivered unassembled.
- Electrical units are optional and will be positioned in the centre of tables as standard.

For product information visit fourdesign.dk ↗

TABLE TOP

Decor



Laminate



Fenix laminate



Linoleum



FRAME COLOURS

Standard



For electrical accessories [go to page 148](#) ↗





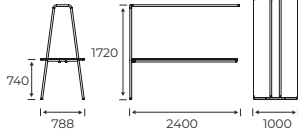

For full colour details [go to page 156](#) ↗

Product	Description (Item nr)	Weight (Kg)	Chair suspension	Dimensions (mm)	Top	Price (SEK)
	65205 FourReal® A XL 74, 180 x 100, A	69.4	6		Decor Laminate Fenix laminate Linoleum	16.268 17.647 20.144 22.468
	65215 FourReal® A XL 74, 200 x 100, A	74.4	6		Decor Laminate Fenix laminate Linoleum	18.076 19.608 22.381 24.964
	65225 FourReal® A XL 74, 240 x 100, A	84.4	8		Decor Laminate Fenix laminate Linoleum	20.660 22.364 25.808 28.391
	65209 FourReal® A XL 74, 180 x 100, A extension	58.7	6		Decor Laminate Fenix laminate Linoleum	13.685 15.063 17.561 19.884
	65219 FourReal® A XL 74, 200 x 100, A extension	63.6	6		Decor Laminate Fenix laminate Linoleum	15.493 17.214 19.797 22.381

For tabletop cutout placements [go to: Fourdesign.dk/Cutout.pdf](https://fourdesign.dk/Cutout.pdf)

Product	Description (Item nr)	Weight (Kg)	Chair suspension	Dimensions (mm)	Top	Price (SEK)
	65229 FourReal® A XL 74, 240 x 100, A extension	77.5	8		Decor	18.076
					Laminate	19.781
					Fenix laminate	23.224
					Linoleum	25.808

For tabletop cutout placements go to: Fourdesign.dk/Cutout.pdf

ACCESSORIES	Description	Weight (Kg)	Dimensions (mm)	Price (SEK)
	CHAIR SUSPENSION Chair suspension for FourCast2 Four, FourCast2 Line, FourSure 44, FourSure 88, FourSure 11, FourSure 99, Four Stools, Four Seating Benches	0,3 Kg		255
	CHAIR SUSPENSION Chair suspension for FourCast2 Wheeler, FourSure 66	0,3 Kg		255
	699000008 Table Accessories, Flower box black, 60 cm	0,4 Kg	L600 x W160 x H140 mm	438
	699000005 Table Accessories, Flower box black, 80 cm	0,5 Kg	L800 x W160 x H140 mm	438
	699000001 Table Accessories, Top shelf white, 60 cm x 20,5 cm	1,5 Kg	600 x 205 mm	438
	699000002 Table Accessories, Top shelf black, 60 cm x 20,5 cm	1,5 Kg	600 x 205 mm	438
	699000003 Table Accessories, Top shelf grey, 60 cm x 20,5 cm	1,5 Kg	600 x 205 mm	438



FEATURES

- Table height 90 cm – integrated castors on two legs.
- Matching ABS edges.
- Chair suspension, Flower box & Top-shelf options.
- Powder coated frame options.
- Delivered unassembled.
- Electrical units are optional and will be positioned in the centre of tables as standard.

For product information visit fourdesign.dk ↗

TABLE TOP

Decor



04 05 06

Laminate



01 02 03

Fenix laminate



07 08 09

Linoleum



10

FRAME COLOURS

Standard



B C K

For electrical accessories [go to page 148](#) ↗

For full colour details [go to page 156](#) ↗

Product	Description (Item nr)	Weight (Kg)	Chair suspension	Dimensions (mm)	Top	Price (SEK)
	65305 FourReal® A XL 90, 180 x 100, A	69.1	6		Decor Laminate Fenix laminate Linoleum	16.268 17.647 20.144 22.468
	65315 FourReal® A XL 90, 200 x 100, A	74.1	6		Decor Laminate Fenix laminate Linoleum	18.076 19.608 22.381 24.964
	65325 FourReal® A XL 90, 240 x 100, A	84	8		Decor Laminate Fenix laminate Linoleum	20.660 22.364 25.808 28.391
	65309 FourReal® A XL 90, 180 x 100, A extension	58.5	6		Decor Laminate Fenix laminate Linoleum	13.685 15.063 17.561 19.884
	65319 FourReal® A XL 90, 200 x 100, A extension	63.5	6		Decor Laminate Fenix laminate Linoleum	15.493 17.214 19.797 22.381

For tabletop cutout placements [go to: Fourdesign.dk/Cutout.pdf](https://fourdesign.dk/Cutout.pdf)





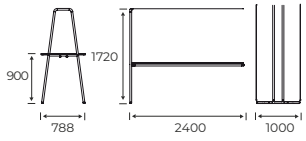

FourReal® A XL 90

Design by Studio Ocee

[Content ↗](#)

Product	Description (Item nr)	Weight (Kg)	Chair suspension	Dimensions (mm)	Top	Price (SEK)
	65329 FourReal® A XL 90, 240 x 100, A extension	73.5	8		Decor	18.076
					Laminate	19.781
					Fenix laminate	23.224
					Linoleum	25.808

For tabletop cutout placements go to: Fourdesign.dk/Cutout.pdf

ACCESSORIES	Description	Weight (Kg)	Dimensions (mm)	Price (SEK)
	CHAIR SUSPENSION Chair suspension for FourCast2 Four, FourCast2 Line, FourSure 44, FourSure 88, FourSure 11, FourSure 99, Four Stools, Four Seating Benches	0,3 Kg		255
	CHAIR SUSPENSION Chair suspension for FourCast2 Wheeler, FourSure 66	0,3 Kg		255
	699000008 Table Accessories, Flower box black, 60 cm	0,4 Kg	L600 x W160 x H140 mm	438
	699000005 Table Accessories, Flower box black, 80 cm	0,5 Kg	L800 x W160 x H140 mm	438
	699000001 Table Accessories, Top shelf white, 60 cm x 20,5 cm	1,5 Kg	600 x 205 mm	438
	699000002 Table Accessories, Top shelf black, 60 cm x 20,5 cm	1,5 Kg	600 x 205 mm	438
	699000003 Table Accessories, Top shelf grey, 60 cm x 20,5 cm	1,5 Kg	600 x 205 mm	438



FEATURES

- Table height 72,5 cm – integrated castors on two legs.
- With height adjustment glides on the other two legs to aid movement.
- Foldable by one person without the use of tools (thickness of folded table 15 cm).
- Matching ABS edges. Powder coated frame options.
- Electrical units are optional.

For product information visit fourdesign.dk ↗

TABLE TOP

Decor



04 05 06

Laminate



01 02 03

Fenix laminate



07 08 09

Linoleum



10

FRAME COLOURS



Standard







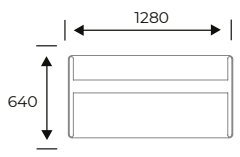

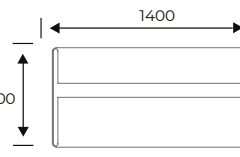
6 B C K

For electrical accessories [go to page 148](#) ↗

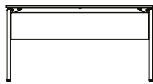
For full colour details [go to page 156](#) ↗

Product	Description (Item nr)	Weight (Kg)	Chair suspension	Dimensions (mm)	Top	Price (SEK)
	11630 Four® Learning, 128 x 64, Folding legs	22.5	2		Decor	7.012
					Laminate	7.866
					Fenix laminate	9.679
					Linoleum	11.511
	11610 Four® Learning, 140 x 70, Folding legs	25.9	2		Decor	7.215
					Laminate	8.233
					Fenix laminate	10.493
					Linoleum	11.879

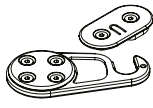
For tabletop cutout placements go to: [Fourdesign.dk/Cutout.pdf](https://fourdesign.dk/Cutout.pdf)

ACCESSORIES	Description	Weight (Kg)	Dimensions (mm)	Price (SEK)
	MODESTY PANEL White			1.314
	MODESTY PANEL Black			1.314
	CHAIR SUSPENSION Chair suspension for FourCast2 Four, FourCast2 Line, FourSure 44, FourSure 88, FourSure 11, FourSure 99, Four Stools, Four Seating Benches	0,3 Kg		255
	CHAIR SUSPENSION Chair suspension for FourCast2 Wheeler, FourSure 66	0,3 Kg		255
	CABLE CUT OUT Cable duct, aluminum. Cable duct placed in apron			2.030
	CABLE CUT OUT			711
	LINKING DEVICE Linking Device, set of 4 pcs - 2 x he, 2 x she per table			525
	TABLE TROLLEY - 20100001 Trolley for 10 Folded Tables or 7 round tables, including strap	20 Kg	1720 mm x 550 mm x 980 mm. Folded Table: 150 mm	8.773



FEATURES

- Table height 72,5 cm – integrated castors on two legs with height adjustment.
- With height adjustment glides on the other two legs to aid movement.
- Foldable by one person without the use of tools.
- Matching ABS edges. Powder coated frame options.
- Electrical units are optional and will be positioned in the centre of tables as standard.

For product information visit fourdesign.dk ↗

TABLE TOP

Decor



Laminate



Fenix laminate



Linoleum



FRAME COLOURS

Standard



For electrical accessories [go to page 148](#) ↗

For full colour details [go to page 156](#) ↗

Product	Description (Item nr)	Weight (Kg)	Chair suspension	Dimensions (mm)	Top	Price (SEK)
	120E0 Four® Eating, 80 x 80 with 80 x 70 frame, Folding legs	17.9	2		Decor Laminate Fenix laminate Linoleum	5.247 7.103 8.551 10.085
	12000 Four® Eating, 120 x 80, Folding legs	23.4	4		Decor Laminate Fenix laminate Linoleum	7.104 8.116 10.265 11.630
	12050 Four® Eating, 140 x 80, Folding legs	28.4	4		Decor Laminate Fenix laminate Linoleum	7.397 8.476 11.137 12.285
	12040 Four® Eating, 160 x 80, Folding legs	31.4	4		Decor Laminate Fenix laminate Linoleum	7.672 9.048 11.984 12.741
	12010 Four® Eating, 180 x 80, Folding legs	34.3	6		Decor Laminate Fenix laminate Linoleum	7.968 9.417 12.855 13.171

For tabletop cutout placements [go to: Fourdesign.dk/Cutout.pdf](http://Fourdesign.dk/Cutout.pdf)



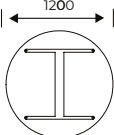

Four® Eating

Design by Strand+Hvass

[Content ↗](#)

Product	Description (Item nr)	Weight (Kg)	Chair suspension	Dimensions (mm)	Top	Price (SEK)
	12020 Four® Eating, Ø 120, Folding legs	24.9	2		Decor	7.735
					Laminate	9.017
					Fenix laminate	12.345
					Linoleum	13.861

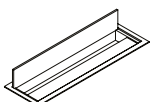
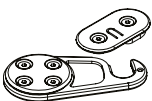
For tabletop cutout placements go to: Fourdesign.dk/Cutout.pdf

ACCESSORIES	Description	Weight (Kg)	Dimensions (mm)	Price (SEK)
	CHAIR SUSPENSION Chair suspension for FourCast2 Four, FourCast2 Line, FourSure 44, FourSure 88, FourSure 11, FourSure 99, Four Stools, Four Seating Benches	0,3 Kg		255
	CHAIR SUSPENSION Chair suspension for FourCast2 Wheeler, FourSure 66	0,3 Kg		255
	CABLE CUT OUT Cable duct, aluminum. Cable duct placed in apron			2.030
	CABLE CUT OUT			711
	LINKING DEVICE Linking Device, set of 4 pcs - 2 x he, 2 x she per table			525
	TABLE TROLLEY - 20100001 Trolley for 10 Folded Tables or 7 round tables, including strap	20 Kg	1720 mm x 550 mm x 980 mm. Folded Table: 150 mm	8.773

Four® Meeting

Design by Strand+Hvass

[Content ↗](#)



FEATURES

- Table height 72,5 cm – integrated castors on two legs.
- With height adjustment glides on the other two legs to aid movement.
- Foldable by one person without the use of tools (thickness of folded table 15 cm).
- Matching ABS edges. Powder coated frame options.
- Electrical units are optional and will be positioned in the centre of tables as standard.

For product information visit fourdesign.dk ↗

TABLE TOP

FRAME COLOURS

Standard



Laminate







Fenix laminate



Linoleum

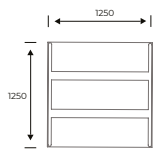

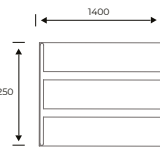
For full colour details [go to page 156](#) ↗

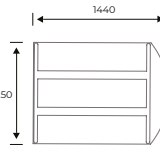

Product	Description (Item nr)	Weight (Kg)	Chair suspension	Dimensions (mm)	Top	Price (SEK)
	11730 Four® Meeting, 125 x 125, Folding legs	42.1	4		Laminate Fenix laminate Linoleum	13.486 18.061 19.362
	11750 Four® Meeting, 125 x 140, Folding legs	45.7	4		Laminate Fenix laminate Linoleum	14.218 18.602 19.881
	11740 Four® Meeting, 125 x 144 D-shape, Folding legs	39.1	4		Laminate Fenix laminate Linoleum	14.797 19.077 20.317

For tabletop cutout placements go to: Fourdesign.dk/Cutout.pdf

Four® Meeting

Design by Strand+Hvass

[Content ↗](#)

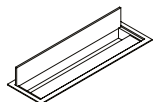
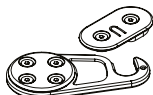
ACCESSORIES	Description	Weight (Kg)	Dimensions (mm)	Price (SEK)
	CHAIR SUSPENSION Chair suspension for FourCast2 Four, FourCast2 Line, FourSure 44, FourSure 88, FourSure 11, FourSure 99, Four Stools, Four Seating Benches	0,3 Kg		255
	CHAIR SUSPENSION Chair suspension for FourCast2 Wheeler, FourSure 66	0,3 Kg		255
	CABLE CUT OUT Cable duct, aluminum. Cable duct placed in apron			2.030
	CABLE CUT OUT			711
	LINKING DEVICE Linking Device, set of 4 pcs - 2 x he, 2 x she per table			525

Four® Standing

Design by Strand+Hvass

[Content ↗](#)



FEATURES

- Table height 90 & 103 cm
- Integrated castors on two legs
- Powder coated frame options
- Matching ABS edges

For product information visit fourdesign.dk ↗

TABLE TOP

Decor



Laminate



Fenix laminate



Linoleum



FRAME COLOURS

Standard



For full colour details [go to page 156](#) ↗





Product	Description (Item nr)	Weight (Kg)	Dimensions (mm)	Top	Price (SEK)
	12323 Four® Standing, 140 x 60, 90 cm	28.2		Decor Laminate Fenix laminate Linoleum	12.429 13.446 16.095 18.294
	12383 Four® Standing, 140 x 80, 90 cm	36.7		Decor Laminate Fenix laminate Linoleum	13.775 15.065 18.726 20.136
	12313 Four® Standing, 180 x 60, 90 cm	35.1		Decor Laminate Fenix laminate Linoleum	12.696 14.069 18.420 19.055
	12393 Four® Standing, 180 x 80, 90 cm	43.1		Decor Laminate Fenix laminate Linoleum	14.069 15.815 20.403 20.815
	12322 Four® Standing, 140 x 60, 103 cm	29.1		Decor Laminate Fenix laminate Linoleum	12.429 13.446 16.095 18.294

For tabletop cutout placements go to: [Fourdesign.dk/Cutout.pdf](https://fourdesign.dk/Cutout.pdf)

Four® Standing

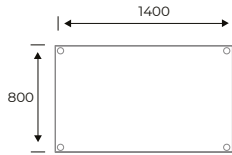
Design by Strand+Hvass

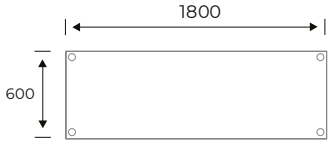
[Content ↗](#)

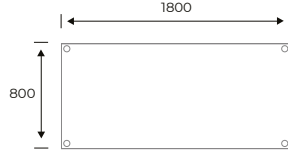
Product	Description (Item nr)	Weight (Kg)	Dimensions (mm)	Top	Price (SEK)
	12382 Four® Standing, 140 x 80, 103 cm	37.6		Decor	13.775
				Laminate	15.065
				Fenix laminate	18.726
				Linoleum	20.136
	12312 Four® Standing, 180 x 60, 103 cm	35.9		Decor	12.696
				Laminate	14.069
				Fenix laminate	18.420
				Linoleum	19.055
	12392 Four® Standing, 180 x 80, 103 cm	44		Decor	14.069
				Laminate	15.815
				Fenix laminate	20.403
				Linoleum	20.815

For tabletop cutout placements go to: Fourdesign.dk/Cutout.pdf

Four® Resting

Design by Strand+Hvass

[Content ↗](#)



FEATURES

- Table height 51, 64, 72 & 103 cm
- Aluminium pedestal 4 and 5-star base
- Castors to table height 51 cm and 72 cm + 5 cm. in height.
- Matching ABS edges
- Powder coated frame options

For product information visit fourdesign.dk ↗

TABLE TOP

Decor



Laminate



Fenix laminate



Linoleum



FRAME COLOURS

Standard



Frame optional*



For full colour details [go to page 156](#) ↗











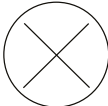

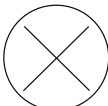







Product	Description (Item nr)	Weight (Kg)	Dimensions (mm)	Top	Price (SEK)
	12240 Four® Resting, Ø 60, 51 cm - 4 Star base	9.3	 Ø 600	Decor	5.103
				Laminate	6.128
				Fenix laminate	7.325
				Linoleum	8.277
	12243 Four® Resting, Ø 60, 64 cm - 4 Star base	9.6	 Ø 600	Decor	5.336
				Laminate	6.370
				Fenix laminate	7.555
				Linoleum	8.518
	12241 Four® Resting, Ø 60, 72,5 cm - 4 Star base	9.9	 Ø 600	Decor	5.336
				Laminate	6.370
				Fenix laminate	7.555
				Linoleum	8.518
	12242 Four® Resting, Ø 60, 103 cm - 4 Star base	10.7	 Ø 600	Decor	5.528
				Laminate	6.559
				Fenix laminate	7.743
				Linoleum	8.718
	12250 Four® Resting, Ø 70, 51 cm - 4 Star base	10.9	 Ø 700	Decor	5.214
				Laminate	6.450
				Fenix laminate	7.937
				Linoleum	8.960

For tabletop cutout placements go to: Fourdesign.dk/Cutout.pdf

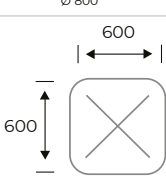
Four® Resting

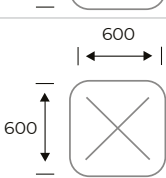
Design by Strand+Hvass

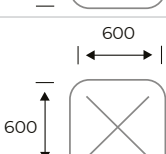
[Content ↗](#)

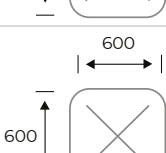









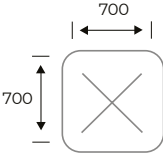

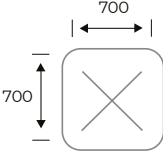

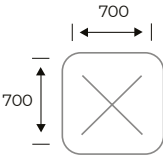

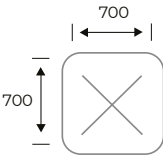

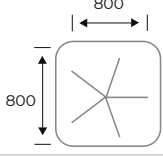

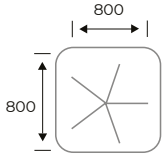
Product	Description (Item nr)	Weight (Kg)	Dimensions (mm)	Top	Price (SEK)
	12253 Four® Resting, Ø 70, 64 cm - 4 Star base	11.2	 Ø 700	Decor	5.466
				Laminate	6.669
				Fenix laminate	8.158
				Linoleum	9.194
	12251 Four® Resting, Ø 70, 72,5 cm - 4 Star base	11.4	 Ø 700	Decor	5.466
				Laminate	6.669
				Fenix laminate	8.158
				Linoleum	9.194
	12252 Four® Resting, Ø 70, 103 cm - 4 Star base	12.2	 Ø 700	Decor	5.647
				Laminate	6.871
				Fenix laminate	8.349
				Linoleum	9.384
	12265 Four® Resting, Ø 80, 51 cm - 5 Star base	12.9	 Ø 800	Decor	5.365
				Laminate	6.792
				Fenix laminate	8.607
				Linoleum	9.323
	12268 Four® Resting, Ø 80, 64 cm - 5 Star base	13.2	 Ø 800	Decor	5.594
				Laminate	7.025
				Fenix laminate	8.830
				Linoleum	9.545
	12266 Four® Resting, Ø 80, 72,5 cm - 5 Star base	13.4	 Ø 800	Decor	5.594
				Laminate	7.025
				Fenix laminate	8.830
				Linoleum	9.545
	12267 Four® Resting, Ø 80, 103 cm - 5 Star base	14.2	 Ø 800	Decor	5.807
				Laminate	7.212
				Fenix laminate	9.029
				Linoleum	9.747
	12230 Four® Resting, 60 x 60, 51 cm - 4 Star base	-	 600 x 600	Decor	5.103
				Laminate	6.128
				Fenix laminate	7.325
				Linoleum	8.277
	12233 Four® Resting, 60 x 60, 64 cm - 4 Star base	10.7	 600 x 600	Decor	5.336
				Laminate	6.370
				Fenix laminate	7.555
				Linoleum	8.518
	12231 Four® Resting, 60 x 60, 72,5 cm - 4 Star base	11	 600 x 600	Decor	5.336
				Laminate	6.370
				Fenix laminate	7.555
				Linoleum	8.518
	12232 Four® Resting, 60 x 60, 103 cm - 4 Star base	11.8	 600 x 600	Decor	5.528
				Laminate	6.559
				Fenix laminate	7.743
				Linoleum	8.718

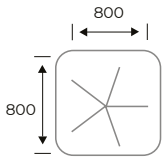
For tabletop cutout placements go to: Fourdesign.dk/Cutout.pdf

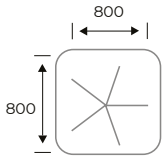
Four® Resting

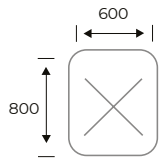
Design by Strand+Hvass

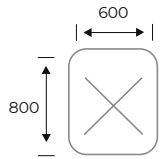
[Content ↗](#)

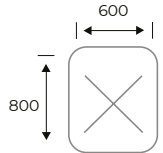
Product	Description (Item nr)	Weight (Kg)	Dimensions (mm)	Top	Price (SEK)
	12200 Four® Resting, 70 x 70, 51 cm - 4 Star base	-		Decor	5.214
				Laminate	6.450
				Fenix laminate	7.937
				Linoleum	8.960
	12203 Four® Resting, 70 x 70, 64 cm - 4 Star base	-		Decor	5.466
				Laminate	6.669
				Fenix laminate	8.158
				Linoleum	9.194
	12201 Four® Resting, 70 x 70, 72,5 cm - 4 Star base	13		Decor	5.466
				Laminate	6.669
				Fenix laminate	8.158
				Linoleum	9.194
	12202 Four® Resting, 70 x 70, 103 cm - 4 Star base	13.8		Decor	5.647
				Laminate	6.871
				Fenix laminate	8.349
				Linoleum	9.384
	12215 Four® Resting, 80 x 80, 51 cm - 5 Star base	15		Decor	5.365
				Laminate	6.792
				Fenix laminate	8.607
				Linoleum	9.323
	12218 Four® Resting, 80 x 80, 64 cm - 5 Star base	15.2		Decor	5.594
				Laminate	7.025
				Fenix laminate	8.830
				Linoleum	9.545
	12216 Four® Resting, 80 x 80, 72,5 cm - 5 Star base	15.5		Decor	5.594
				Laminate	7.025
				Fenix laminate	8.830
				Linoleum	9.545
	12217 Four® Resting, 80 x 80, 103 cm - 5 Star base	16.3		Decor	5.807
				Laminate	7.212
				Fenix laminate	9.029
				Linoleum	9.747
	12220 Four® Resting, 80 x 60, 51 cm - 4 Star base	12.3		Decor	5.214
				Laminate	6.450
				Fenix laminate	7.925
				Linoleum	8.578
	12223 Four® Resting, 80 x 60, 64 cm - 4 Star base	12.6		Decor	5.466
				Laminate	6.669
				Fenix laminate	8.146
				Linoleum	8.821
	12221 Four® Resting, 80 x 60, 72,5 cm - 4 Star base	12.8		Decor	5.466
				Laminate	6.669
				Fenix laminate	8.146
				Linoleum	8.821

For tabletop cutout placements go to: Fourdesign.dk/Cutout.pdf

Four® Resting

Design by Strand+Hvass

[Content ↗](#)

Product	Description (Item nr)	Weight (Kg)	Dimensions (mm)	Top	Price (SEK)
	12222 Four® Resting, 80 x 60, 103 cm - 4 Star base	-		Decor	5.655
				Laminate	6.861
				Fenix laminate	8.357
				Linoleum	9.001

[For tabletop cutout placements go to: Fourdesign.dk/Cutout.pdf](https://Fourdesign.dk/Cutout.pdf)

ACCESSORIES	Description	Weight (Kg)	Dimensions (mm)	Price (SEK)
	CHAIR FEET Castors			651
	CHAIR FEET Felt glides, set of 4 pcs. height + 0,2 cm	1,82 g x 4		208
	FLIP TOP With Flip Top			2.730

SURCHARGE		Price (SEK)
FRAME OPTIONAL	 B C K	1075

Harc Tub Table

Design by Roger Webb Associates

[Content ↗](#)



FEATURES

- Table height 40 cm
- Powder coated frame options
- Chamfered edge
- 5 star base is available on request

For product information visit fourdesign.dk ↗

TABLE TOP

Laminate







FRAME COLOURS

Standard

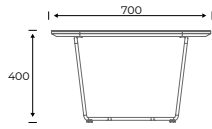

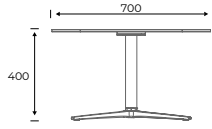
For full colour details [go to page 156](#) ↗

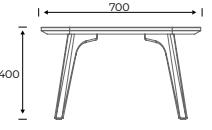
Product	Description (Item nr)	Weight (Kg)	Dimensions (mm)	Top	Price (SEK)
	HARCTUBT11 Harc Tub Table, 70 x 70, Skid frame	-		Laminate	6.025
	HARCTUBT12 Harc Tub Table, 70 x 70, 4 Star base	-		Laminate	6.889
	HARCTUBT13 Harc Tub Table, 70 x 70, Wooden legs	-		Laminate	16.382

For tabletop cutout placements go to: [Fourdesign.dk/Cutout.pdf](https://fourdesign.dk/Cutout.pdf)

Y-Table

Design by Osko + Deichmann

[Content ↗](#)



FEATURES

- Height adjustable
- Fold-away allows for nesting storage
- Designed for disassembly at end of life
- Cable management hook
- Height lever doubles up as a handle for portability
- Designed to complement products across all our families
- Tested according to EN 16139, L2 and EN15372 for stability

For product information visit fourdesign.dk ↗

TABLE TOP

Fenix laminate



FRAME COLOURS

Standard

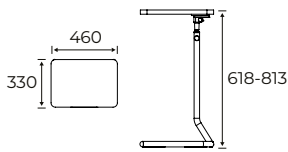

For full colour details [go to page 156](#) ↗

Product	Description (Item nr)	Weight (Kg)	Dimensions (mm)	Top	Price (SEK)
	ATYT63 Y-Table, 46 cm x 33 cm	4.6		Fenix laminate	4.103









FEATURES



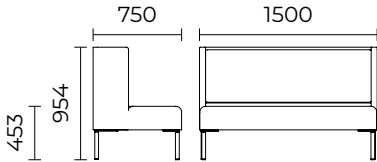

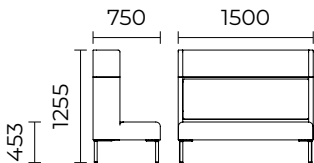

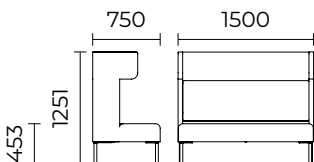
- Acoustic and visual privacy
- Linking options
- Uni- or Multicolored
- Facility friendly; designed for optimal cleaning
- Optional: Castors, Skid frame, InnoTab tablet, Magazine holder, Shelf (height 95 cm).
- Electrical units are optional and will be positioned on the left or right side of sofas as standard.

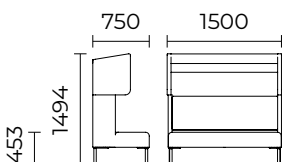

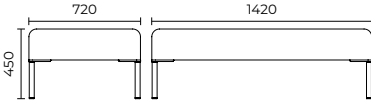

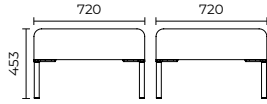
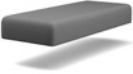

For product information visit fourdesign.dk ↗

For electrical accessories [go to page 148](#) ↗

For full band and colour details [go to page 158](#) ↗

Product	Description (Item nr)	Weight (Kg)	Dimensions (mm)	Band	Same colour (SEK)	Different colour (SEK)
	80000 FourUs®, Bench	52 kg		1 2 3 4 5 8	19.880 21.785 23.319 24.773 28.463 52.361	
	80001 FourUs®, Extension	64 kg		1 2 3 4 5 8	24.812 26.944 28.659 30.263 34.884 64.583	
	80002 FourUs®, Ear	58 kg		1 2 3 4 5 8	26.176 28.020 29.648 31.472 36.690 66.569	
	80003 FourUs®, Cave	70 kg		1 2 3 4 5 8	30.253 32.423 34.440 36.461 43.179 81.938	

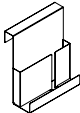
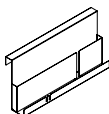
Product	Description (Item nr)	Weight (Kg)	Dimensions (mm)	Band	Same colour (SEK)	Different colour (SEK)
	80004 FourUs®, Daybed	25 kg		1 2 3 4 5 8	10.081 10.767 11.310 11.897 13.693 21.514	
	80005 FourUs®, Stool	16 kg		1 2 3 4 5 8	8.064 8.778 9.184 9.789 10.484 13.894	
	80000-S FourUs®, Bench, Seat			1 2 3 4 5 8		2.574 3.176 4.044 4.739 5.517 8.097
	80000-C FourUs®, Bench, Cushion			1 2 3 4 5 8		2.574 2.996 3.052 3.297 3.534 5.753
	80001-T FourUs®, Extension, Top			1 2 3 4 5 8		1.807 1.986 2.505 3.033 3.554 4.963
	80002-T FourUs®, Ear, Top			1 2 3 4 5 8		2.210 2.791 3.522 4.091 4.802 6.835
	80003-T FourUs®, Cave, Top			1 2 3 4 5 8		4.058 5.215 6.344 7.313 8.448 10.504

ACCESSORIES	Description	Weight (Kg)	Dimensions (mm)	Price (SEK)
	FOURUS LEGS Castors			3.960
	FOURUS LEGS Skid frame			3.742
	160800L InnoTab, FourUs, Left			3.872
	160800R InnoTab, FourUs, Right			3.872
	899010 FourUs® Optional Extras, Magazine holder black, 30 cm	4,9 Kg	300 x 352 mm	1.089
	899020 FourUs® Optional Extras, Magazine holder black, 70 cm	5,6 Kg	700 x 325 mm	1.484
	899100 FourUs® Optional Extras, Shelf black	5,8 Kg	L1412 mm	5.949





FEATURES

- Acoustic and visual privacy. Uni- or multicoloured.
- Facility friendly; designed for optimal cleaning.
- Inclusive black Fenix-laminate tablet (21 mm) – placed on the right side as standard.
- Standard leg frame black (RAL 7021). Optional: Castors or Skid frame.
- Electrical units are optional and will be positioned on the left or right side of sofas as standard.

For product information visit fourdesign.dk ↗

For electrical accessories [go to page 148](#) ↗

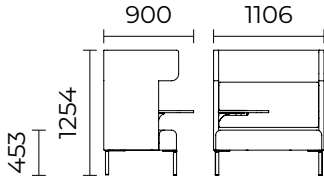
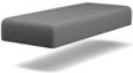
For full band and colour details [go to page 158](#) ↗

Product	Description (Item nr)	Weight (Kg)	Dimensions (mm)	Band	Same colour (SEK)	Different colour (SEK)
	80016 FourUs® Solo with black tablet,	64 kg		1 2 3 4 5 8	25.783 27.601 29.203 31.004 36.139 65.571	
	80016-S FourUs® Solo with black tablet, Seat			1 2 3 4 5 8		2.512 2.923 2.975 3.218 3.451 6.683
	80016-C FourUs® Solo with black tablet, Cushion			1 2 3 4 5 8		2.512 2.923 2.975 3.218 3.451 6.683
	80016-T FourUs® Solo with black tablet, Top			1 2 3 4 5 8		2.337 3.093 3.786 4.564 5.269 7.450

FourUs® Solo

Design by Nørgaard Design

[Content ↗](#)

ACCESSORIES	Description	Weight (Kg)	Dimensions (mm)	Price (SEK)
	FOURUS LEGS Castors			3.960
	FOURUS LEGS Skid frame			3.742

Harc Tub

Design Roger Webb Associates









For data information, certificates and product description please refer to our website www.fourdesign.dk

- Two-tone fabric option
- 5 star base is available on request

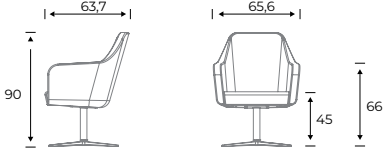

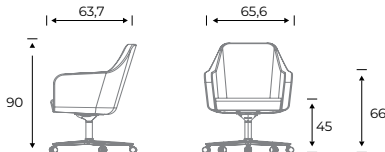

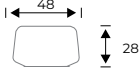
		Dimensions (cm)		Band	Price
	HARCTUBLB1 Low Back Lounge Chair Skid Frame			1 2 3 4 5 6 7	11.186 11.573 12.151 12.922 14.277 15.818 17.366
	HARCTUBLB2 Low Back Lounge Chair 4-star Polished Aluminium Swivel & Tilt Base			1 2 3 4 5 6 7	12.151 12.538 13.115 13.887 15.242 16.783 18.331
	HARCTUBLB3 18 Kg Low Back Lounge Chair Wooden Frame			1 2 3 4 5 6 7	16.012 16.399 16.977 17.749 19.103 20.645 22.192
	HARCTUBHB1 High Back Lounge Chair Skid Frame			1 2 3 4 5 6 7	14.371 14.949 15.723 16.688 18.426 20.547 23.057
	HARCTUBHB2 High Back Lounge Chair 4-star Polished Aluminium Swivel & tilt Base			1 2 3 4 5 6 7	15.336 15.914 16.688 17.652 19.391 21.512 24.022
	HARCTUBHB3 High Back Lounge Chair Wooden Frame			1 2 3 4 5 6 7	19.198 19.775 20.549 21.514 23.252 25.373 27.883

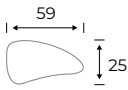
Harc Tub Meeting

Design Roger Webb Associates

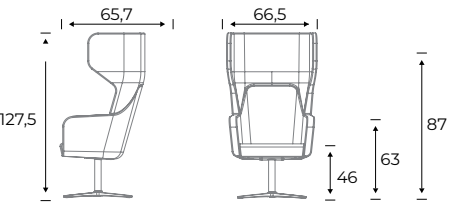
		Dimensions (cm)	Band	Price
	HARCTUBMB2 Low Back Meeting Chair 4-star Polished Aluminium Swivel & Tilt Base		1	12.151
			2	12.538
			3	13.115
			4	13.887
			5	15.242
			6	16.783
			7	18.331
	HARCTUBMB6 Low back meeting chair 5 star polished aluminium base with castors		1	11.186
			2	11.573
			3	12.151
			4	12.922
			5	14.277
			6	15.818
			7	17.366
	HARCTUHR Headrest option for all Harc Low Back Tub Chairs and Meeting Chairs		1	2.562
			2	2.688
			3	2.811
			4	2.965
			5	3.273
			6	3.616
			7	4.015
	TABLET Tablet option for Harc meeting with a 4 star base and Harc meeting with 5 star base and castors*			4.055

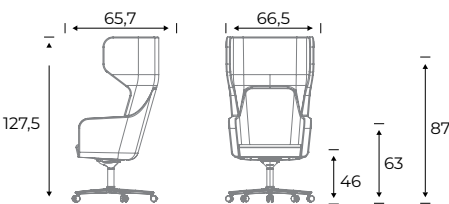
*Tablet not available on 4 and 5 star base with swivel return option

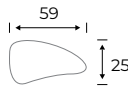
	HARCTUBMH2 High back meeting chair 4-star polished aluminium swivel & tilt base		1	15.336
			2	15.914
			3	16.688
			4	17.652
			5	19.391
			6	21.512
			7	24.022
	HARCTUBMH6 High back meeting chair 5-star polished aluminium base with castors		1	14.371
			2	14.949
			3	15.723
			4	16.688
			5	18.426
			6	20.547
			7	23.057
	TABLET Tablet option for Harc meeting with a 5 star base and castors*			4.055

*Tablet not available on 4 and 5 star base with swivel return option

Harc Tub Meeting

Design Roger Webb Associates

Specifications & Options

- Low and high back option on all models
- Moulded foam for additional comfort and durability
- Two-tone fabric option
- Headrest option for all Harc Low Back tub chairs and Meeting chairs

Frame options

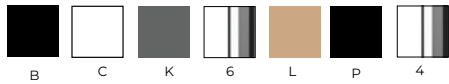

Black, White, Warm Grey, chrome, oak oiled, oak stained black, aluminium (chairs with swivel base only)



Learn more:
fourdesign.dk/Sustainability

Let's furnish the world *better*

When we design a product, we consider every stage of the products lifecycle to ensure we are making responsible choices throughout all areas of the company. Each stage has the possibility to effect the next and so the whole picture is considered. Responsible manufacturing not only looks at the materials and where they are sourced, but also the manufacturing site and resources consumed; the use and durability of the product; the packaging and delivery service; as well as the product's end-of-life.

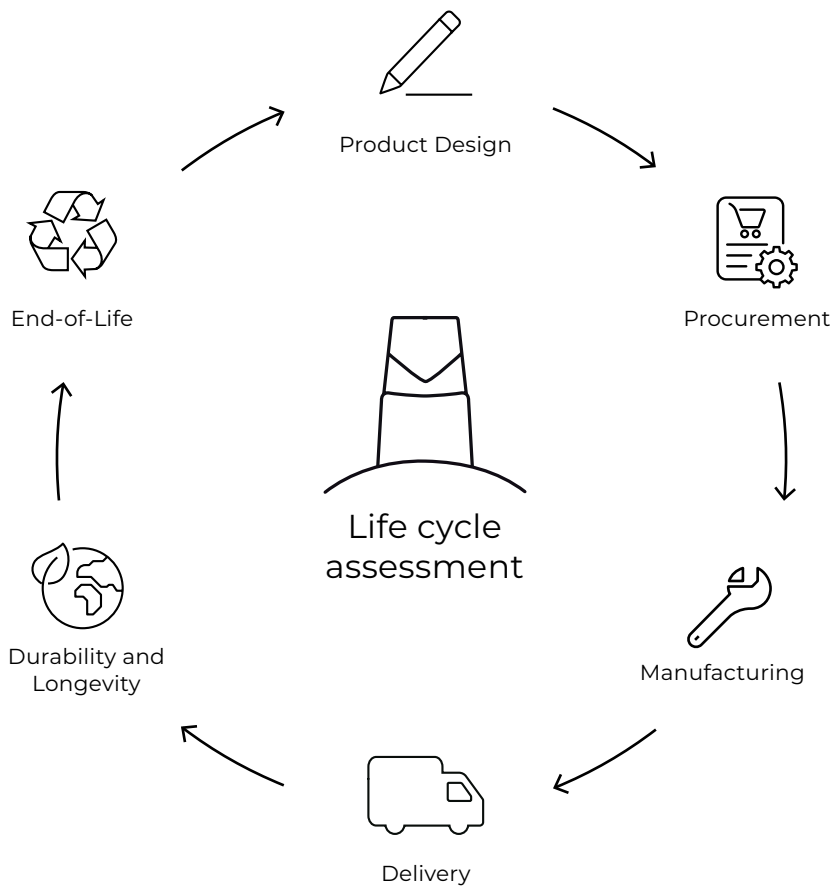

Our furniture are
tested for Globally use



Learn more:
fourdesign.dk/environment ↗



The following images are for illustrative purposes only. The finished product will contain standardised sockets based on the country of your choice. Please note prices include our team supplying products with prepared hole for unit installation. Please note, for tables, the electrical unit will be delivered separately, please follow the assembly instructions provided with your order to install the unit. For soft seating, the electrical unit will be preinstalled.

EVOLINE		PRICE (SEK)
	<p>EVOLINE ONE BLACK (APO00101)</p> <p>Ø60 Socket, 13 A, contactprotected. Power supply module with cable and connector, plug, cable length 3.0 m, black with lock. Power supply module with cable and connector, socket, cable length 3.0 m, black without lock.</p>	<p>FourReal® FourReal® A Four®Learning Four®Eating Four®Meeting Four®Mat FourLikes® T FourLikes® FourLikes® Meet FourLikes® Scooter (1400/2100)</p> <p>FourUs® Work/Booth (tabletop) Harc Sofa/Modular Harc Booth tabletop FourPeople Sofas/Booths/Huts</p> <p>1.865</p>
	<p>EVOLINE ONE WHITE (APO00102)</p> <p>Ø60 Socket, 13 A, contactprotected. Power supply module with cable and connector, plug, cable length 3.0 m, black with lock. Power supply module with cable and connector, socket, cable length 3.0 m, black without lock.</p>	<p>FourReal® FourReal® A Four®Learning Four®Eating Four®Meeting Four®Mat FourLikes® T FourLikes® FourLikes® Meet FourLikes® Scooter (1400/2100)</p> <p>FourUs® Work/Booth (tabletop) Harc Sofa/Modular Harc Booth tabletop FourPeople Sofas/Booths/Huts</p> <p>1.865</p>
	<p>EVOLINE ONE USB BLACK (APO00201)</p> <p>USB socket, charging function only. Rated output current: 2100 mA; Type A + C. Power supply module with cable and connector, plug, cable length 3.0 m, black with lock. Power supply module with cable and connector, socket, cable length 3.0 m, black without lock.</p>	<p>FourReal® FourReal® A Four®Learning Four®Eating Four®Meeting Four®Mat FourLikes® T FourLikes® FourLikes® Meet FourLikes® Scooter (1400/2100)</p> <p>FourUs® Work/Booth (tabletop) Harc Sofa/Modular Harc Booth tabletop FourPeople Sofas/Booths/Huts</p> <p>2.566</p>
	<p>EVOLINE ONE USB WHITE (APO00202)</p> <p>USB socket, charging function only. Rated output current: 2100 mA; Type A + C. Power supply module with cable and connector, plug, cable length 3.0 m, black with lock. Power supply module with cable and connector, socket, cable length 3.0 m, black without lock.</p>	<p>FourReal® FourReal® A Four®Learning Four®Eating Four®Meeting Four®Mat FourLikes® T FourLikes® FourLikes® Meet FourLikes® Scooter (1400/2100)</p> <p>FourUs® Work/Booth (tabletop) Harc Sofa/Modular Harc Booth tabletop FourPeople Sofas/Booths/Huts</p> <p>2.566</p>
	<p>EVOLINE FRAMEDOCK BLACK (APF3010102)</p> <p>2 x Socket Modules, 13 A, contactprotected. 1 x Socket Modules, USB socket, charging function only. Rated output current: 2100 mA; Type A + C. Power supply module with cable and connector, plug, cable length 3.0 m, black with lock. Power supply module with cable and connector, socket, cable length 3.0 m, black with lock.</p>	<p>FourReal® FourReal® A Four®Learning Four®Eating Four®Meeting Four®Mat Harc Sofa/Modular</p> <p>3.370</p>
	<p>EVOLINE FRAMEDOCK SILVER ANODISED (APF3030102)</p> <p>2 x Socket Modules, 13 A, contactprotected. 1 x Socket Modules, USB socket, charging function only. Rated output current: 2100 mA; Type A + C. Power supply module with cable and connector, plug, cable length 3.0 m, black with lock. Power supply module with cable and connector, socket, cable length 3.0 m, black with lock.</p>	<p>FourReal® FourReal® A Four®Learning Four®Eating Four®Meeting</p> <p>3.370</p>

EVOLINE

PRICE (SEK)



EVOLINE DOCKFIX BLACK (APD3010102)

2 x Socket Modules, 13 A, contactprotected. 1 x Socket Modules, USB socket, charging function only. Rated output current: 2100 mA; Type A + C. Power supply module with cable and connector, plug, cable length 3.0 m, black with lock. Power supply module with cable and connector, socket, cable length 3.0 m, black with lock. With sidebrackets for sub-mounting.

FourUs®
FourUs® Booth
FourUs® Work Booth
FourUs® Solo
FourUs® 3 Seater
FourUs® Corner

3,668



CHAIRS

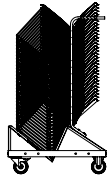

CHAIR TROLLEY - 200X0

Chair trolley for:

FourSure® 44
 FourSure® 44 Armrest
 FourSure® 88
 FourSure® 88 Armrest
 FourCast® 2 Four
 FourCast® 2 Four Armrest
 FourCast® 2 Line
 FourCast® 2 Line Armrest

200A0
 200C0
 200F0
 200I0

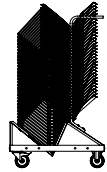

CHAIR TROLLEY - 200X0

Chair trolley for:

FourCast® 2 Four Seat/Fully
 FourCast® 2 Four Seat/Fully Arm
 FourCast® 2 Line Seat/Fully
 FourCast® 2 Line Seat/Fully Arm
 FourCast® 2 Line Veneer
 FourSure® 44 Inside/Seat/Fully
 FourSure® 44 Seat/Arm
 FourSure® 44 Inside/Arm
 FourSure® 88 Seat
 FourSure® 88 Inside
 FourSure® 88 Seat/Inside Arm

20020
 20030
 20060
 20090
 20070
 200B0
 200E0
 200D0
 200G0
 200H0
 200J0



SACK TROLLEY - 200X1

Chair trolley for:

FourCast® 2 Four
 FourCast® 2 Line
 FourSure® 44
 FourSure® 88

200I1
 20051
 200A1
 200F1

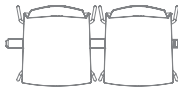

LINKING DEVICE

Chair linking under seat

FourCast® 2 Four/Seat
 FourCast® 2 Line/Seat
 FourSure® 44
 FourSure® 88
 FourCast® 2 Four/Fully
 FourCast® 2 Line/Fully
 FourSure® 44 Seat/Inside
 FourSure® 88 Seat/Inside



LINKING DEVICE

Chair linking on frame

FourCast® 2 Line
 FourSure® 88

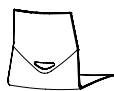

GRIP HOLE

Grip hole is available for chairs without inside – and full upholstery.

GRIP



INNO

Inno® Note – A slim writing tablet matches a 13" laptop and has integrated cupholder. 24 x 59 cm

FourCast® 2 Four
 FourCast® 2 Line
 FourSure® 44
 FourSure® 88

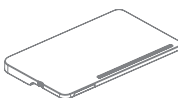







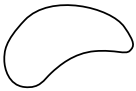

INNO

Inno® Tab - Writing tablet with integrated with integrated cup holder and dashboard for tablet and phone. 52 x 32 cm

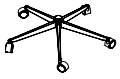
FourCast® 2 Wheeler
 FourSure® 66
 FourMe® 66
 FourCast® 2 Audi
 FourSure® Audi

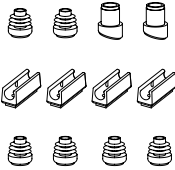
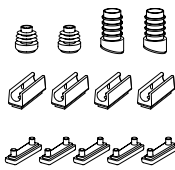
CHAIRS

	<p>INNO®NOTE TROLLEY - 20100007 Trolley for Inno®Note. Room for 51 Inno®Notes</p>	<p>FourCast® 2 Four FourCast® 2 Line FourSure® 44 FourSure® 88</p>	<p>20100007</p>
 <p>B</p>	<p>INNO Inno® Tab B – Writing tablet and powder coated frame with integral cup holder and coat hook. 585 x 308 mm.</p>	<p>White Antchracite</p>	
 <p>C</p>	<p>INNO Inno® Tab C – Writing tablet and powder coated frame with integral cup holder and coat hook. 475 x 278 mm.</p>	<p>White Antchracite</p>	
	<p>HOOK</p>	<p>FourCast2® Wheeler FourSure® 66</p>	
	<p>GASFOOT Incl. foot ring</p>	<p>FourCast® 2 Wheeler FourSure® 66 FourMe® 66</p>	<p>GASFOOT GASFOOT GASFOOT</p>
	<p>WHEELS</p>	<p>FourCast® 2 Evo FourCast® 2 XL/XL Plus FourSure® 99 FourMe® 99</p>	
	<p>STANDARD POLYIMIDE GLIDES Chair height + 0,2 cm</p>	<p>FourCast® 2 Wheeler FourSure® 66 FourMe® 66</p>	
	<p>TEFLON GLIDERS Set of 4 pcs. Chair height + 0,2 cm</p>	<p>FourCast® 2 Four / Eco FourCast® 2 Line / Eco FourCast® 2 Counter/High / Eco FourCast® 2 Counter/High Four / Eco FourCast® 2 One FourSure® 44 / Eco FourSure® 88 / Eco FourSure® 90/105/Eco FourSure® 11 + FourSure® 99 FourMe® 44 + FourMe® 88 FourMe® 11 + FourMe® 99 Four® Stools Four® Seating Benches</p>	
	<p>FELT GLIDES Set of 4 pcs. Chair height + 0,2 cm</p>	<p>FourCast® 2 Four / Eco FourCast® 2 Line / Eco FourCast® 2 Counter/High / Eco FourCast® 2 Counter/High Four / Eco FourCast® 2 One FourCast® 2 Evo FourCast® 2 XL/Plus FourCast® 2 Lounge FourSure® 44 / Eco FourSure® 88 / Eco FourSure® 90/105 / Eco FourSure® 11 + FourSure® 99 FourMe® 44 + FourMe® 88 FourMe® 11 + FourMe® 99 FourMe® Lounge</p>	
	<p>FELT GLIDES FOR WOODEN LEGS Set of 4 pcs. Chair height + 0,2 cm.</p>	<p>FourCast® 2 Four FourSure® 44 FourMe® 44</p>	

CHAIRS

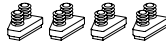

**FELT GLIDES
STOOLS & BENCHES
WOODEN LEGS**
4-pack. Sitthöjd + 0,2 cm

Four® Stools wooden legs
Four® Seating Benches wooden legs

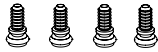

FEET/GLIDERS/CASTORS
Noise reducing ferrule with felt.
Set of 4 pcs. Chair height + 1 cm

FourCast® 2 Four
FourCast® 2 One
FourSure® 44
FourSure® 11
FourMe® 44
FourMe® 11

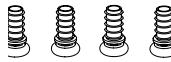

FEET/GLIDERS/CASTORS
Noise reducing ferrule with big
diameter (reduces pressure marks).
Set of 4 pcs. Chair height + 0,8 cm

FourCast® 2 Four
FourCast® 2 One
FourSure® 44
FourSure® 11
FourMe® 44
FourMe® 11



**CHAIR SEAT-ROW -
ACSR0201**
11 mm - no. 1 - 25

FourCast® 2 Line
Eco Label FourCast® 2 Line
Fire Retardent FourCast® 2 Line
FourSure® 88
Eco Label FourSure® 88

ACSR0201



**CHAIR SEAT-ROW -
ACSR0202**
11 mm - no. 26 - 50

FourCast® 2 Line
Eco Label FourCast® 2 Line
Fire Retardent FourCast® 2 Line
FourSure® 88
Eco Label FourSure® 88

ACSR0202



**CHAIR SEAT-ROW -
ACSR0101**
16 mm - no. 1 - 25

FourCast® 2 Four
Eco Label FourCast® 2 Four
Fire Retardent FourCast® 2 Four
FourSure® 44
Eco Label FourSure® 44

ACSR0101















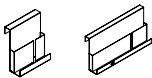
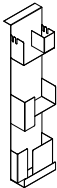

**CHAIR SEAT-ROW -
ACSR0102**
16 mm - no. 26 - 50

FourCast® 2 Four
Eco Label FourCast® 2 Four
Fire Retardent FourCast® 2 Four
FourSure® 44
Eco Label FourSure® 44

ACSR0102

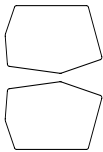
TABLES			
	<p>TABLE TROLLEY - 20100001 Trolley for 10 folded tables or 7 round tables, including strap. 20 Kg. L: 172 x W: 55 x H: 98 cm Folded Table: 15 cm</p>	<p>Four® Learning Four® Eating FourReal® 74 FourReal® 90 FourReal® 105 FourReal® 741 Flake</p>	<p>20100001 20100001 20100001 20100001 20100001 20100001</p>
	<p>CHAIR SUSPENSION Chair suspension for FourCast2 Four, FourCast2 Line, FourSure 44, FourSure 88, FourSure 11, FourSure 99, Four Stools, Four Seating Benches</p>	<p>Four® Learning Four® Eating Four® Meeting FourReal® 74 FourReal® 90 FourReal® 105 FourReal® 741 Flake</p>	<p>CS1</p>
	<p>CHAIR SUSPENSION Chair suspension for FourCast2 Wheeler, FourSure 66</p>	<p>Four® Learning Four® Eating FourMeeting FourReal® FourReal® 90 FourReal® 105 FourReal® 741 Flake</p>	<p>CS2</p>
	<p>CABLE CUT OUT Cable duct, aluminum. Cable duct placed in apron</p>	<p>Four® Learning Four® Eating Four® Meeting FourReal®</p>	<p>CD</p>
	<p>CD Cable duct, single, incl., hole in table top. Aluminium.</p>	<p>Four® Mat</p>	<p>CD1</p>
	<p>CD Cable duct, double, incl., hole in table top. Aluminium.</p>	<p>Four® Mat</p>	<p>CD2</p>
	<p>FRLINK Linking Device, set of 4 pcs - 2 x he, 2 x she per table</p>	<p>Four® Learning Four® Eating Four® Meeting FourReal®</p>	
	<p>CASTORS Castors height adjustable wheel in black with brakes. Set of 4 pieces</p>	<p>FourFold®</p>	<p>CF</p>
	<p>CASTORS</p>	<p>Four® Resting</p>	
	<p>HOLE Pre-drilled hole for power</p>	<p>All tables</p>	
<p>60 cm x 13 cm x 15 cm 80 cm x 13 cm x 15 cm</p>	<p>FLOWER BOX FourReal A 74 + 90 FourReal A.XL 74 + 90 FourReal AV</p>	<p>Black 600 mm Black 800 mm</p>	<p>699000008 699000005</p>
	<p>TOP-SHELF FourReal A 74 + 90 FourReal A.XL 74 + 90 FourReal AV</p>	<p>White 600 mm x 205 mm Black 600 mm x 205 mm Grey 600 mm x 205 mm</p>	<p>699000001 699000002 699000003</p>

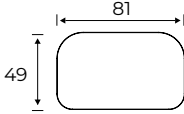
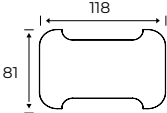
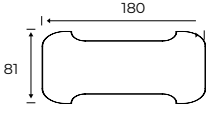

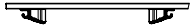



















SOFT SEATING			
	LINKING DEVICE 2 her x 2 him	FourLikes®	
	LINKING DEVICE Linking Device	FourLikes® Scooter	
	FEET Feet for FourLikes Scooter	FourLikes® Scooter	
	WHEELS	FourLikes® Scooter	
	INNO® TAB LEFT Black Fenix-Laminate <i>*Only with standard legs</i> L: 480 x W: 300 mm	FourUs® FourUs® 3-seater FourUs® Booth 2 FourUs® Booth	16082-1A1-92
	INNO® TAB RIGHT Black Fenix-Laminate <i>*Only with standard legs</i> L: 480 x W: 300 mm	FourUs® FourUs® 3-seater FourUs® Booth 2 FourUs® Booth	16072-1A1-92
	SHELF Black Fenix-Laminate L: 1500 x W: 300 mm Heigh from floor: 905 mm	FourUs® FourUs® Booth FourUs® Work Booth	8990J-101-13
	CASTORS	FourUs® FourUs® Solo	8990K-100-00
	SKID FRAME	FourUs® FourUs® 3-seater FourUs® Booth 2 FourUs® Booth FourUs® Corner FourUs® Solo	8990M-500-00
	MAGAZINE HOLDER W: 300 mm / 700 mm	FourUs® FourUs® 3-seater FourUs® Booth 2 FourUs® Booth FourUs® Corner FourUs® Work Booth	8990T-000-99 / 8990T-001-99
	MAGAZINE HOLDER, BLACK B: 225 x D: 95 x H: 970 mm	FourUs® Booth FourUs® Booth 2 FourUs® Work Booth	8990T-B00-99
	MAGAZINE HOLDER, WHITE B: 225 x D: 95 x H: 970 mm		8990T-C00-99
	MAGAZINE HOLDER, GREY B: 225 x D: 95 x H: 970 mm		8990T-K00-99
	PIVOT TABLE Black Fenix-laminate	FourUs® Booth 2 FourUs® Booth	85045

SOFT SEATING					
	PIVOT TABLE, RIGHT L: 1380 x B: 750 x H: 720 mm	FourUs® Work Booth			870GS-106
	PIVOT TABLE, LEFT L: 1380 x B: 750 x H: 720 mm				870GS-107
	TV BRACKET Option hidden cable	FourUs® Booth 2 FourUs® Booth FourUs® Work Booth			8100T-100-00
	CABLE MANAGEMENT TV Pre-drilled hole in wall for cables	FourUs® Booth 2 FourUs® Booth FourUs® Work Booth			
	CABLE MANAGEMENT STANDARD Fabric with velcro for concealing cable underneath the table	FourUs® Booth 2 FourUs® Booth FourUs® Work Booth			
ACOUSTIC					
	TABLE TOP (1 pcs. chair suspension) Colours: 08 Warm grey, 38 Antracit, 10 Black	InnoPod®	08 ● 38 ● 10 ●		62100
	TABLE TOP (1 pcs. chair suspension) Colours: 08 Warm grey, 38 Antracit, 10 Black	InnoPod®	08 ● 38 ● 10 ●		62101
	TABLE TOP (No chair suspension) Colours: 08 Warm grey, 38 Antracit, 10 Black	InnoPod®	08 ● 38 ● 10 ●		62103
	CS1 Chair suspension for FourCast2 Four, FourCast2 Line, FourSure 44, FourSure 88, FourSure 11, FourSure 99, Four Stools, Four Seating Benches	InnoPod®			23099-002-99
	CS2 Chair suspension for FourCast2 Wheeler, FourSure 66	InnoPod®			23099-003-99

Chair shell colours

 01 / SNOW RAL 9010	 02 / EBONY BLACK NCS S 9000-N	 03 / ANTHRACITE RAL 7015
 14 / WHITE Fire Retardant RAL 9010	 05 / AQUA NCS S 4020-B	 06 / JUNGLE GREEN NCS 4050-G40Y
 07 / ORIENTAL RED NCS S 1580-R	 08 / ORANGE NCS S 2070-Y70R	 09 / OLIVE NCS S 2040-G80Y
 10 / BEACH NCS S 2502-Y	 12 / TERRACOTTA NCS S 4510-Y60R	 13 / CLAY NCS S 6005-Y10R
 17 / PINE NCS S 5005-B80G	 18 / MOSS NCS S 5010-C70Y	
 31 / OAK	 32 / OAK BLACK	

Chair frame colours

 C / MATT WHITE RAL 9010	 B / MATT BLACK RAL 7021	 K / WARM GREY RAL 7039
 E / ANTHRACITE RAL 7024 gl.5	 M / AQUA S4020-B IGP 581 TA 52240 A 00	 O / JUNGLE GREEN IGP 681 TA 64014 A 00
 Q / ORIENTAL RED IGP 581 TA 33080 A 00	 N / ORANGE IGP 681 TA 21349 A 00	 S / OLIVE RAL 7042 gl. 5
 T / BEACH IGP 681 TA 77644 A 00	 7 / TERRACOTTA	 A / CLAY
 D / PINE	 F / MOSS	 4 / ALUMINIUM
 5 / MAT CHROME	 6 / CHROME	 9 / BLACK
 P / OAK STAINED BLACK	 L / OAK OILED	
 V / OAK LACQUERED BLACK	 U / OAK CLEAR MATT LACQUERED	

We reserve the right to change the standard surfaces / colours.

Tabletops

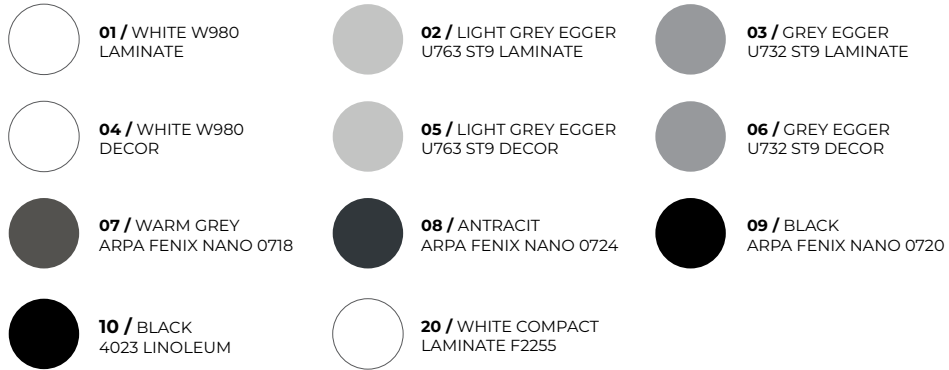

FOURMAT

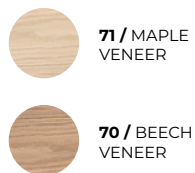

HARC TUB TABLE



Table frames



Outdoor tabletops



Outdoor frame



This is just a selection of the cover options available. We are able to source alternative fabrics. Please contact info@fourdesign.dk for details.

Disclaimer – This fabric can be used on the listed products, but we believe that a better finish can be achieved from other fabric selections.

Shade – Only certain shades of the fabric are appropriate for use on these products. Please contact us for details.

Sample – Our upholstery experts will sample the suitability of this material range upon request.

FABRIC SUPPLIERS:

www.camirafabrics.com, www.gabriel.dk, www.kvadrat.dk

InnoPod®

Band 1

Go Check, Main Line Flax, Main Line Plus, Patina, Step Melange

Band 2

Crisp, Europost2, Fame, Select, Chili, Nejma, Passion

Fabricks™

Band 3

Blazer Lite, *Blazer

Tessellate

Band 1: Tempt

Band 3: Blazer Lite

Band 5: Canvas

	Sustainability factor	Soft Seating/ RoomInRoom	Harc Tub High Back/FourLikes Meet 1400+700	Fully Upholstered FourCast/FourSure	FourMe	Seat & Inner Upholstered FourCast/FourSure
Band 1						
Aspect	Camira ♥ ♻️ ↓	Yes	Yes	Yes	Yes	Yes
Advantage	Camira ♥ ♻️	Yes	Yes	Yes	Yes	Yes
Atlas	Kvadrat ♥ ♻️	Yes	Shade	Shade	Shade	Shade
Canopy	Camira ♥ ♻️	Yes	FLM 700+1400 only	Yes	Yes	Yes
Clara 2	Kvadrat ♥ ♻️	Yes	Shade	Yes	Yes	Yes
Connect	Gabriel ♥ ♻️ ♻️ ↓	Yes	Yes	Yes	Yes	Yes
Cura	Gabriel ♥ ♻️ ♻️ ↓	Yes	SHADE	Yes	Yes	Yes
Era	Camira ♥ ♻️	Yes	Yes	Yes	Yes	Yes
Event	Gabriel ♥ ♻️	No	No	Yes	Yes	Yes
Felicity	Gabriel ♥ ♻️ ♻️ ↓	Yes	SHADE	Yes	Yes	Yes
Field 2	Kvadrat ♥ ♻️ ♻️ ↓	Disclaimer	No	Disclaimer	Disclaimer	Yes
Go Check	Gabriel ♥ ♻️	Yes	SHADE	Yes	Yes	Yes
Go Couture	Gabriel ♥ ♻️	Yes	SHADE	Yes	Yes	Yes
Go Uni	Gabriel ♥ ♻️	Yes	SHADE	Yes	Yes	Yes
Gravity	Camira ♥ ♻️ ↓	No	No	Disclaimer	Disclaimer	Disclaimer
Halcyon Aspen	Camira ♥	Yes	No	Yes	No	Yes
Halcyon Blossom	Camira ♥	Yes	No	Yes	No	Yes
Halcyon Cedar	Camira ♥	Yes	No	Yes	No	Yes
Main Line Plus	Camira ♥	Yes	Yes	Yes	Yes	Yes
Main Line Flax	Camira ♥ ♻️	Yes	Yes	Yes	Yes	Yes
Manila	Camira ♥	Yes	No	Yes	No	Yes
Manhattan	Camira ♥ ♻️ ♻️ ↓	Yes	No	Yes	Yes	Yes
Patina	Camira ♥ ♻️	Yes	Yes	Yes	Yes	Yes
Phoenix	Camira ♥ ♻️ ♻️ ↓	No	No	Disclaimer	Disclaimer	Disclaimer
Quest	Camira ♥ ♻️ ♻️ ↓	Yes	Yes	Yes	Yes	Yes
Repetto	Gabriel ♥ ♻️ ♻️ ♻️ ↓	Yes	SHADE	Yes	Yes	Yes
Rivet	Camira ♥ ♻️ ♻️ ♻️ ↓	No	No	Disclaimer	Disclaimer	Disclaimer
Step	Gabriel ♥ ♻️ ♻️ ↓	Yes	Yes	Yes	Yes	Yes
Step Melange	Gabriel ♥ ♻️ ♻️ ↓	Yes	Yes	Yes	Yes	Yes
Tempt	Gabriel ♥ ♻️ ♻️ ↓	Yes	shade	Yes	Yes	Yes
Tonal	Gabriel ♥ ♻️ ♻️ ♻️ ↓	Sample	Sample	Yes	Yes	Sample
Urban	Camira ♥ ♻️ ♻️ ↓	No	No	No	No	Yes
Vita Vinyl	Camira ♥	Yes	Sample	Yes	No	Yes
Valencia	Spradling ♥	Yes	Harc Tub Hood only	Yes	No	Yes
Xtreme	Camira ♥ ♻️ ♻️ ↓	Yes	Yes	Yes	Yes	Yes
Band 2						
Aquarius	Camira ♥ ♻️ ♻️ ↓	Yes	Yes	Yes	Yes	Yes
Blazer*	Camira ♥ ♻️ ♻️ ↓	Yes	Yes	Yes	Yes	Yes
Chili	Gabriel ♥ ♻️ ♻️ ↓	Yes	Yes	Yes	Yes	Yes
Contour	Gabriel ♥ ♻️ ♻️ ↓	Sample	Sample	Sample	Sample	Sample
Crisp	Gabriel ♥ ♻️ ♻️ ↓	Yes	Yes	Yes	Yes	Yes
Deca	Camira ♥ ♻️ ♻️ ↓	Yes	No	Sample	No	Sample
Europost 2	Gabriel ♥ ♻️ ♻️ ↓	Yes	No	Yes	Yes	Yes
Fame	Gabriel ♥ ♻️ ♻️ ↓	Yes	Yes	Yes	Yes	Yes
Fame Hybrid	Gabriel ♥ ♻️ ♻️ ↓	Yes	Yes	Yes	Yes	Yes
Harmony	Gabriel ♥ ♻️ ♻️ ↓	Yes	Yes	Yes	Yes	Yes
Hi-Tech	Camira ♥ ♻️ ♻️ ↓	No	No	Sample	Sample	Sample
Honeycomb	Camira ♥ ♻️ ♻️ ↓	Yes	No	No	No	No
Hemp	Camira ♥ ♻️ ♻️ ↓	Yes	Yes	Yes	Yes	Yes
Intervene Plain	Camira ♥ ♻️ ♻️ ♻️ ↓	Yes	No	Yes	No	Yes
Intervene Texture	Camira ♥ ♻️ ♻️ ♻️ ↓	Yes	No	Yes	No	Yes
Just	Gabriel ♥ ♻️ ♻️ ♻️ ↓	Sample	Sample	Yes	Yes	Sample
Kyoto	Camira ♥ ♻️ ♻️ ↓	Square units	No	No	No	Yes
Landscape Balance	Camira ♥ ♻️ ♻️ ↓	Yes	Sample	Yes	Yes	Yes
Landscape Contact	Camira ♥ ♻️ ♻️ ↓	Yes	Sample	Yes	Yes	Yes
Medley	Gabriel ♥ ♻️ ♻️ ↓	Yes	Yes	Yes	Yes	Yes
Noma	Gabriel ♥ ♻️ ♻️ ↓	Yes	Yes	Yes	Yes	Yes
Oxygen (MOQ)	Camira ♥ ♻️ ♻️ ↓	Yes	Yes	Yes	Yes	Yes
Oceanic	Camira ♥ ♻️ ♻️ ♻️ ↓	Yes	Sample	Yes	Yes	Sample
Passion	Gabriel ♥ ♻️ ♻️ ↓	Yes	Yes	Yes	Yes	Yes
Regent (MOQ)	Camira ♥ ♻️ ♻️ ↓	Yes	No	No	No	No

	Sustainability factor	Soft Seating/ RoomInRoom	Harc Tub High Back/FourLikes Meet 1400+700	Fully Upholstered FourCast/FourSure	FourMe	Seat & Inner Upholstered FourCast/FourSure
Band 2 (cont)						
Remix	Kvadrat ♥ ♻️	Yes	Yes	Yes	Yes	Yes
Rhythm	Gabriel ♥ ♻️	No	No	No	No	No
Runner	Gabriel ♥ ♻️ ↓	No	No	No	No	Yes
Select	Gabriel ♥ ♻️	Yes	Yes	Yes	Yes	Yes
Savoy	Gabriel ♥ ♻️ ↓	Yes	No	No	No	No
Silk	Camira ♥ ♻️ 🌿 ↓	Yes	Yes	Yes	Yes	Yes
Sumi	Camira ♥ ♻️	Yes	Yes	Yes	Yes	Yes
Synergy	Camira ♥ ♻️ ♻️	Yes	Yes	Yes	Yes	Yes
Track	Camira ♥ ♻️ ↓	Yes	No	No	No	No
X2	Camira ♥ ♻️ ♻️ ↓	Yes	Yes	Yes	Yes	Yes
Yoredale	Camira ♥	Yes	Yes	Yes	Yes	Yes
24/7 +	Camira	Sample	Sample	Yes	Yes	Sample
24/7 Flax	Camira ♥ ♻️	Yes	Yes	Yes	Yes	Yes
Band 3						
Armadillo	Camira ♥ ♻️	Yes	Yes	Yes	Yes	No
Atlantic	Gabriel ♥ ♻️	Yes	Shade	Yes	Yes	Yes
Bond	Gabriel ♥ ♻️ ♻️ ↓	Yes	Yes	Yes	Yes	Sample
Breeze & Breeze Fus.	Gabriel ♥ ♻️	Yes	Yes	Yes	Yes	Yes
Hebden (MOQ)	Camira ♥ ♻️ 🌿	Yes	Yes	Yes	Yes	No
Illusion	Nevotex ♥	Yes	Sample	Yes	Yes	Yes
Individuo	Camira ♥ ♻️	Yes	Yes	Yes	Yes	No
Mainline Flax Stripe	Camira ♥ ♻️ 🌿	Yes	Sample	Yes	Yes	No
GaYes Classic	Gabriel ♥ ♻️	Yes	Yes	Yes	Yes	Yes
Obika Leather	Gabriel ♥ ♻️	Yes	No	Yes	No	No
Rondo	Gabriel ♥ ♻️ ♻️ ↓	Yes	Shade	Yes	Yes	Sample
Melange Nap	Kvadrat ♥ ♻️	Yes	Shade	Yes	Yes	Shade
Re-wool	Kvadrat ♥ ♻️ 🌿 ↓	Yes	Yes	Yes	Yes	Yes
Zap	Camira ♥ ♻️	Yes	Yes	Yes	Yes	No
Band 4						
Capture	Gabriel ♥ ♻️	Yes	Yes	Yes	Yes	Yes
Craggan Flax	Camira ♥ ♻️	Yes	Harc Tub only	Yes	Yes	No
Divina Melange 2	Kvadrat ♥ ♻️ 🌿	Yes	Yes	Yes	Yes	Yes
Mood	Gabriel ♥ ♻️	Yes	Harc Tub only	Sample	Sample	Sample
Nettle- Aztec	Camira ♥ ♻️	Yes	Harc Tub only	Yes	Yes	No
Silvertex	Camira	Yes	Yes	Yes	Yes	Yes
Band 5						
Canvas 2	Kvadrat ♥ ♻️	Yes	Shade	Shade	Shade	Shade
Criss Cross	Gabriel ♥ ♻️	Yes	Sample	Yes	Yes	No
Fiord	Kvadrat ♥ ♻️	Yes	Yes	Yes	Yes	Yes
Morph	Gabriel ♥ ♻️	Sample	Sample	Sample	Sample	Sample
Revive 1	Kvadrat ♥ ♻️ ♻️ ↓	Yes	Yes	Yes	Yes	Yes
Steelcut 2	Kvadrat ♥ ♻️	Yes	Yes	Yes	Yes	Yes
Steelcut Trio 3	Kvadrat ♥ ♻️	Yes	Yes	Yes	Yes	Yes
Band 6						
Hallingdal 65	Kvadrat ♥ ♻️	Yes	Yes	Yes	Yes	Yes
Band 7						
Luna 2	Gabriel ♥ ♻️	Yes	Yes	Yes	Yes	No
Vintage L	Camira	Yes	Harc Tub only	Yes	No	Yes
Divina 3	Kvadrat ♥ ♻️ 🌿	Yes	Yes	Yes	Yes	Yes
Band 8						
Sort læder		Yes	Yes	Yes	Yes	Yes
Band 10						
Læder, farvet		Yes	Yes	Yes	Yes	Yes

♥	People Certification	Certified for low VOC i.e. Oeko-tex, Greenguard Gold, Indoor Air Quality etc.
♻️	Planet Certification	Certified for low environmental impact i.e. Ecolabel, Cradle-to-cradle etc.
♻️	Recycled materials	Using either post-industrial or post-consumer recycled fibres. Using less energy and resources whilst resolving a potential waste issue.
🌿	100% Natural material	Natural fibres like wool and hemp are naturally fire retardant and therefore may not need added FR chemicals (depending on requirements).
↓	Less resource intensive	Materials that use less water, energy or chemicals within production.

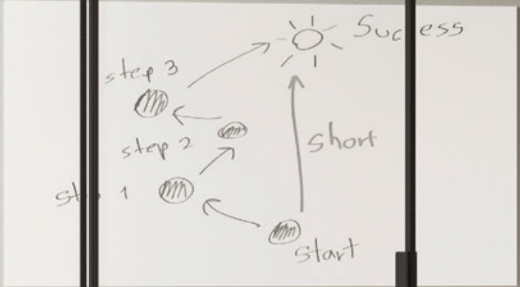

You are Always Welcome in our Showrooms

Aarhus
+45 4016 6565
Balticagade 15
DK-8000 Aarhus C
Denmark

Copenhagen
+45 2030 7122
Carl Jacobsensvej 16
DK-2500 Valby
Denmark

Odense
+45 6229 1132
Lucernemarken 17-19
DK-5260 Odense S.
Denmark

Oslo
+47 9953 0223
Drammensveien 130
0277 Oslo
Norway

Hasselt
+32 4775 31654
Thonissenlaan 18 B
B-3500 Hasselt
Belgium

Düsseldorf
+49 1722 8042 42
Düsseldorfer Str 16
DE-40699 Erkrath
Germany

London
20 Old Street
Clerkenwell
London, EC1V 9AB
United Kingdom

Northampton
Caswell Road
Brackmills Industrial Est.
Northampton, NN4 7PW
United Kingdom

Four Design products are available worldwide

North America
hightoweraccess.com

Hightower

Oceania
fusefurniture.com.au

fuse

China
Novah.cn

NOVAH
SYSTEM TECHNOLOGY

® Four Design 2022/2023

fourdesign.dk
info@fourdesign.dk

instagram | facebook

FOUR
DESIGN

AN OCEE
INTERNATIONAL
COMPANY