

PRICE LIST 2023

POUL KJÆRHOLM

SWEDISH KRONA, EXCL. VAT / 01.2023

FRITZ HANSEN

CONTENT

- 03 • General terms and conditions
- 04 • General terms and conditions

CHAIRS

- 05 • PK8™
- 06 • PK9™
- 07 • PK11™

LOUNGE AND SOFAS

- 08 • PK22™
- 09 • PK25™
- 10 • PK0 A™
- 11 • PK26™
- 12 • PK31™
- 13 • PK80™
- 14 • PK81™
- 15 • PK33™
- 16 • PK91™
- 17 • PK24™
- 18 • PK20™

TABLES

- 19 • PK71™
- 20 • PK60™
- 21 • PK61™/PK61A™
- 22 • PK51™/PK55™
- 23 • PK54™/PK54A™
- 24 • PK58™
- 25 • PK40™
- 26 • PK65™
- 27 • PK62™
- 28 • PK63™/PK63A™

- 29 • SURFACE SELECTION

GENERAL TERMS AND CONDITIONS

CURRENCY & EFFECTIVE DATE

This price list is valid from 14 January 2023 and cancels all prior price lists.

Reservation is made for any errors and omissions. Furthermore, below general terms and conditions shall apply to all contracts under which Fritz Hansen A/S (Fritz Hansen) is the supplier/sub-supplier.

ORDERING

Orders must be placed through Fritz Hansen's web-based order system called the Partner Portal (www.fritzhansen.com - professional). Orders are not binding until the customer has received a written order confirmation from Fritz Hansen.

Price lists state the recommended retail price (RRP) or prices excl. VAT exclusive of freight and fees. All prices can be changed without notice. Changes to the collection such as discontinued products and/or items out of stock can occur even when stated differently in the price list. Updated information will be available on the partner portal only.

ORDER CANCELLATION

Orders can be cancelled in accordance with the below rules:

	ORDERS CANCELLED 0-3 DAYS AFTER ORDER CONFIRMATION HAS BEEN SENT	ORDERS CANCELLED 3-14 DAYS AFTER ORDER CONFIRMATION HAS BEEN SENT
STANDARD PRODUCTS	FEE: NONE	FEE: 5% OF NET PRICE EXCL. VAT.
SPECIALS OR MODIFIED PRODUCTS	FEE: FULL PRICE	

Change and cancellation of order after 14 days from receipt of the order confirmation is not possible.

DELIVERY

The following freight rates apply:

RATE	PER ORDER
EU+UK+NO+CH+US*	DKK 200 / € 55 / £ 50 / SEK 600 / NOK 550 / USD 55 EXCL. VAT.
REST OF THE WORLD	TO BE PICKED UP AT FRITZ HANSEN WAREHOUSES

For markets EU+UK+NO+CH+US free freight offered according to the following rates: Free shipping from DKK 3.000 / € 400 / £ 350 / SEK 4.500 / NOK 4.000 / USD 500 total order value excl. VAT.

* For deliveries to outer areas such as islands in Portugal and Spain as well as Svalbard in Norway and others, a surcharge of DKK 420 / € 56 / £ 42 / NOK 580 per parcel will apply.

Standard delivery terms:

- Denmark: DDP delivery address (INCO-Terms 2020)
- Countries within the EU: DDP delivery address (INCO-Terms 2020)
- European countries outside the EU: DAP delivery address (INCO-Terms 2020)
- USA & Canada: DDP delivery address (INCO-Terms 2020)
- Japan: DDP delivery address (INCO-Terms 2020)
- South Korea: DAT Seoul Airport (INCO-Terms 2020)
- Middle East, Asia, South and Central America, Australia: FCA Fritz Hansen warehouses in Denmark and Poland (INCO-Terms 2020)

For FCA: The goods must be picked up at the Fritz Hansen warehouses no later than 30 calendar days after the confirmed shipping date of the consolidated order. Address(es) for pickup will be specified on the commercial invoice. If the goods are not picked up, Fritz Hansen will charge the customer DKK 24 / € 3 / USD 4 per day per pallet.

If the partner so desires, Fritz Hansen can deliver at the end user's address against an additional fee.

CLAIMS

The physical product must be inspected upon delivery. Damage incurred in transit as well as any defects and deficiencies on the product incurred as a result of transportation must be recorded on the POD upon delivery. Fritz Hansen must be notified in writing of any claims about product defects and deficiencies within 48 hours of delivery. If the claims are made in due time and with the acceptance of Fritz Hansen, the customer is entitled to demand a replacement delivery or to have the defect remedied. The customer cannot demand a reduction or a compensation. Claims/replacements can only be made to the customer's address if delivery has not been made directly to the end user.

TERMS OF PAYMENT

Terms of payment are 30 days net cash from invoice date. Invoices are issued and dated when the goods are dispatched. In case of late payment, interest will be charged at a rate of 1.5 % for every month or part thereof as from the due date. Interest invoices are payable net cash within eight days. Fritz Hansen can decide that the customer shall pay in advance, if the customer's balance is or has previously been due, or if the order amount exceeds the credit limit approved by Fritz Hansen.

OBSERVATION OF TITLE

Title to the goods shall not pass to the customer until Fritz Hansen (or any third party to whom Fritz Hansen has assigned its rights to the purchase price) has received the full purchase price and been reimbursed any expenses incurred.

WARRANTY

Fritz Hansen provides a standard five-year warranty on standard products within the collections Furniture, Outdoor and Skagerak Indoor against defects in materials and workmanship. For the Furniture collection an extended warranty of up to 10 years is provided on selected products, provided they have been registered online on www.fritzhansen.com/my-fh (see table on the following page for details).

For the Poul Kjærholm collection the standard warranty is 20 years except for PK0 A™ and PK60™ which is 10 years and wicker which is 2 years.

For the Lighting, Accessories and Skagerak Accessories collection the standard warranty is 2 years. Specific for the Lighting category: Transformers, ballasts, light sources, and other electronic devices are subject to the warranty terms of the manufacturer in question. Fritz Hansen does not cover costs related to installation and dismantling, replacement of ballasts/transformers and other similar costs related to electricians and the like.

The warranty on all collections does not extend to ordinary wear, tear or damage to upholstery. On any material, fabric, or leather which is not listed in our price lists configured on a specific product, the standard warranty is 2 years. The warranty is void upon subsequent changes to the product.

Additional warranty conditions can be found on www.fritzhansen.com.

LIMITATION OF LIABILITY

Fritz Hansen will assume no liability for any loss as a result of delays, defects or any other breach of contract, unless such loss was caused by gross negligence on the part of Fritz Hansen. Fritz Hansen will assume no liability for any indirect loss, including loss of profits, operating loss, goodwill, loss of customers, running costs or any other consequential economic loss.

CHOICE OF LAW AND JURISDICTION

Disputes between Fritz Hansen and its customers shall be subject to Danish law, except for the international civil law rules of Danish law, and shall be settled by Fritz Hansen’s home court.

MEASUREMENTS

The stated measurements act only as a guideline. The measurements can vary, and size difference on a product can occur.

FORCE MAJURE

Fritz Hansen is without liability for non-performance of Fritz Hansen’s obligations in respect to any orders received, if such non-performance is due to circumstances out of Fritz Hansen’s reasonable control, which prevent the fulfilment of the purchase agreement or makes the fulfilment unreasonably burdensome. As examples of such circumstances the following can be mentioned: Industrial dispute and other circumstances which are beyond the control of the parties, such as fire, war, mobilization or calling in for military service of similar extent, requisition, seizure, exchange controls, riots or disturbances, shortage of means of transportation, ordinary scarcity of goods, restrictions of motive power and defects in or late performance from sub-suppliers due to any of the aforementioned circumstances.

The above circumstances only lead to exemption from liability if their influence on the fulfilment of the purchase agreement could not be anticipated at the conclusion of the agreement. Fritz Hansen must without undue delay notify the customer in writing if any such circumstances, occurrence and cessation, if Fritz Hansen wishes to invoke any grounds of exemption from liability.

Regardless of what follows from these general conditions of sales and delivery, any party is entitled to terminate the purchase agreement by notifying the other party in writing, if the fulfilment of the agreement is prevented for more than 6 months due to one of the above circumstances.

Unless mandatory rules preclude this, Fritz Hansen is in no case liable to the customer for operating losses, lost earnings, or other financial consequential damages under these general conditions for sale and delivery.

PRIVACY POLICY

At Fritz Hansen, confidentiality and data protection is a high priority. Guidelines for processing of personal data and description of the customer’s and end users’ rights according to applicable data protection law is governed by Fritz Hansen’s privacy policy available on Fritz Hansen’s website.

WARRANTY OVERVIEW

Price list collections	Furniture collection						Poul Kjærholm collection		Outdoor collection	Skagerak indoor collection	Lighting collection	Accessories collection	Skagerak Accessories collection						
	Fabric	Leather (1)	Leather (2)	Bases (3)	Bases (4)	Movable parts (5)	Cushions	Shells	Tabletops (6)	Tabletops	China Chair™	Wicker	PKO A™ & PK60™	Poul Kjærholm collection	Outdoor	Skagerak indoor	Lighting	Accessories	Skagerak collection
2 years												x					x	x	x
5 years	x	x		x		x	x		x						x	x			
10 years			x*		x*			x*	x*				x**						
20 years										x**			x**						

- 1. Leather: Soft and Essential
- 2. Leather: Aura, Rustik, Natural, Grace and Embrace
- 3. Bases: Lacquered and Wooden (chairs), Powder coated (chairs and tables)
- 4. Bases: Aluminium, Chrome and Wooden (tables)
- 5. Moveable parts: Automatic return, Tilt, Height-adjustable, Swivel, Castors and Extension mechanism
- 6. Tabletops: Lacquer under tabletop, Lacquer on edges and Surface on tabletop

* Additional with registration on www.fritzhansen.com/my-fh
 ** Standard without registration



PK8™
POUL KJÆRHOLM 1978/2007

01.2023

The PK8™ chair comes with a black or white shell front upholstered in a select range of leather types. The three-legged base is made of anodised satin brushed aluminium, while the shell is made of nylon.

MODEL	DESCRIPTION	CATEGORY 4	CATEGORY 5
PK8	Chair, 44 cm, anodised satin brushed aluminium legs	24.529	29.923

CATEGORY 4: AURA
CATEGORY 5: GRACE

PK8

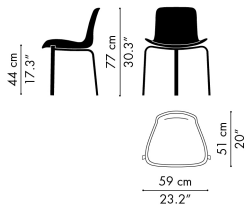



PK9™
POUL KJÆRHOLM 1960

01.2023

The PK9™ is a fully upholstered chair in a select range of leather types. The three-legged base is made of satin brushed stainless spring steel. The inner shell is made of nylon.

MODEL	DESCRIPTION	CATEGORY 4	CATEGORY 5
PK9	Chair, 43 cm, satin brushed stainless spring steel legs	50.913	57.059

CATEGORY 4: AURA
 CATEGORY 5: GRACE, EMBRACE, RUSTIK, NATURAL

SURCHARGE
 DESCRIPTION

SURCHARGE

Glides	-
--------	---

PK9

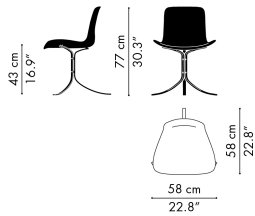



PK11™
POUL KJÆRHOLM 1957

01.2023

The PK11™ armchair comes with armrests in lacquered ash and an upholstered seat in a select range of leather types. The base is made of satin brushed stainless steel.

MODEL	DESCRIPTION	CATEGORY 4	CATEGORY 5
PK11	Armchair, 43/44 cm, satin brushed stainless steel legs	32.844	36.949

CATEGORY 4: AURA
CATEGORY 5: GRACE, EMBRACE, RUSTIK, NATURAL

PK11

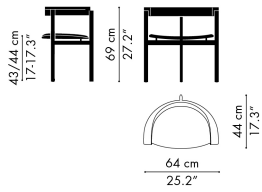



PK22™
POUL KJÆRHOLM 1956

01.2023

The PK22™ lounge chair is available in wicker, canvas and a select range of leather types. The base is made of satin brushed stainless spring steel.

MODEL	DESCRIPTION	WICKER	CANVAS	CATEGORY 4	CATEGORY 5
PK22	Lounge chair, satin brushed stainless spring steel base	35.311	35.311	44.056	51.001

CATEGORY 4: AURA
CATEGORY 5: GRACE, EMBRACE, RUSTIK, NATURAL

CANVAS COLOURS - SEE THE SURFACE SELECTION
NATURAL, BLACK

PK22

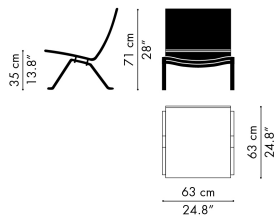



PK25™
POUL KJÆRHOLM 1951

01.2023

The PK25™ lounge chair is available in flag halyard, in natural or black. The base is made of matt chromed spring steel.

MODEL	DESCRIPTION	FLAG HALYARD
PK25	Lounge chair, matt chromed spring steel base	103.164

FLAG HALYARD COLOURS - SEE THE SURFACE SELECTION
NATURAL, BLACK

PK25

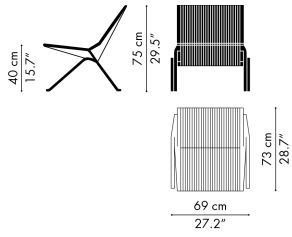



PKO A™
POUL KJÆRHOLM 1952

01.2023

The PKO A™ lounge chair is made from two pressure moulded veneer shells and is available in two different finishes: Oregon Pine or black coloured ash. Between the two shell parts are two cinnabar red spacers.

MODEL	DESCRIPTION	BLACK COLOURED ASH	OREGON PINE
PKO A	Lounge chair, pressure moulded veneer	22.417	23.663

PKO A

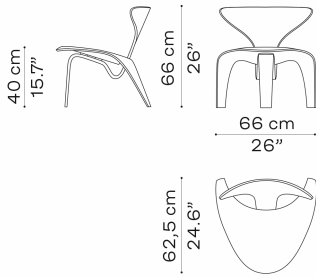



PK26™
POUL KJÆRHOLM 1956

01.2023

The PK26™ is a wall-mounted modular sofa. The frame is made in matt chromed spring steel, and the cushion core is made of hairlok (natural fibres and latex). The sofa is upholstered in a select range of leather types and an exclusive leather type called Niger leather (special trading terms apply).

MODEL	DESCRIPTION	CATEGORY 4	CATEGORY 5	NIGER LEATHER
PK26	1-seater sofa, wall-mounted, matt chromed spring steel frame	162.059	190.657	261.536
PK26	2-seater sofa, wall-mounted, matt chromed spring steel frame	324.117	381.315	523.074

NOTE
 SPECIAL TRADING TERMS APPLY TO NIGER LEATHER - PLEASE CONTACT SALES SUPPORT FOR FURTHER INFORMATION: SALESUPPORT@FRITZHANSEN.COM.
 NIGER LEATHER IS ONLY AVAILABLE IN A LIMITED QUANTITY.

CATEGORY 4: AURA
 CATEGORY 5: GRACE, EMBRACE, RUSTIK, NATURAL

PK26-1

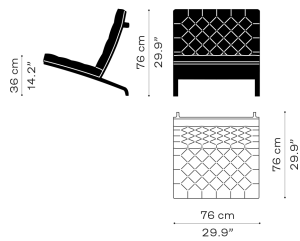

PK26-2

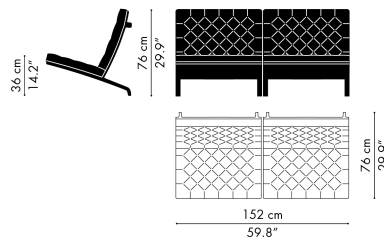



PK31™ POUL KJÆRHOLM 1958

01.2023

The PK31™ series is available as a lounge chair and a 2- or 3-seater sofa. It comes in a select range of leather types. The frame is made of matt chromed spring steel. Additional modules can be added.

MODEL	DESCRIPTION	CATEGORY 4	CATEGORY 5
PK31	Lounge chair, matt chromed spring steel base	149.516	168.159
PK31/2	2-seater sofa, matt chromed spring steel base	249.191	281.996
PK31/3	3-seater sofa, matt chromed spring steel base	348.847	395.832
	Additional modules for PK31, matt chromed spring steel base	99.659	113.834

CATEGORY 4: AURA
CATEGORY 5: GRACE, EMBRACE, RUSTIK, NATURAL

PK31

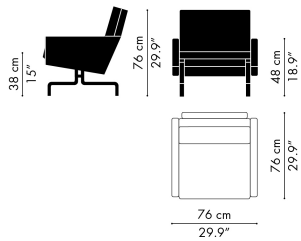

PK31/2

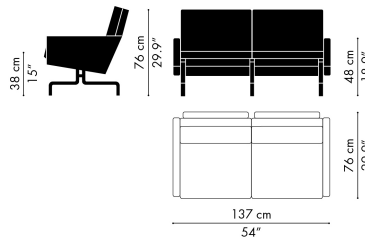

PK31/3

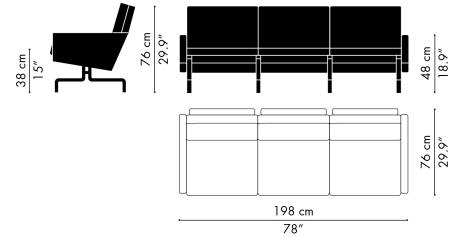

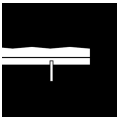

PK80™
POUL KJÆRHOLM 1957

01.2023

The PK80™ daybed comes with a cushion upholstered in a select range of leather types as well as in canvas. It rests on a painted plywood bedplate, and the cushion core is made of granulated foam and hairlok (natural fibres and latex). The base is made of satin brushed stainless steel.

MODEL	DESCRIPTION	CANVAS	CATEGORY 4	CATEGORY 5
PK80	Daybed, satin brushed stainless steel base	104.644	156.603	178.542

CATEGORY 4: AURA
CATEGORY 5: GRACE, EMBRACE, RUSTIK, NATURAL

CANVAS COLOURS - SEE THE SURFACE SELECTION
NATURAL

PK80

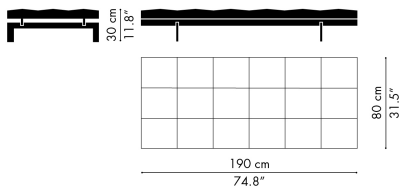

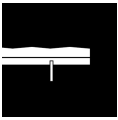

PK81™
POUL KJÆRHOLM 1959

01.2023

The PK81™ daybed is a square version of the classic daybed PK80™. The base is made of satin brushed stainless steel and the daybed rests on a painted plywood bedplate. The cushion core is made of granulated foam and hairlok (natural fibres and latex) and comes upholstered in a select range of leather types as well as in an exclusive leather type called Buffalo leather (special trading terms apply).

MODEL	DESCRIPTION	CATEGORY 4	CATEGORY 5	BUFFALO LEATHER
PK81	Daybed, satin brushed stainless steel base	220.398	259.294	325.687

NOTE

SPECIAL TRADING TERMS APPLY TO BUFFALO LEATHER - PLEASE CONTACT SALES SUPPORT FOR FURTHER INFORMATION: SALESUPPORT@FRITZHANSEN.COM. BUFFALO LEATHER IS ONLY AVAILABLE IN A LIMITED QUANTITY.

CATEGORY 4: AURA
 CATEGORY 5: GRACE, EMBRACE, RUSTIK, NATURAL

PK81

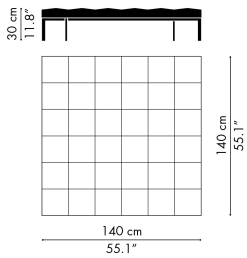



PK33™
POUL KJÆRHOLM 1959

01.2023

The PK33™ stool is available with a detachable cushion in a select range of leather types or canvas. The three-legged stool has a matt chromed spring steel base.

MODEL	DESCRIPTION	CANVAS	CATEGORY 4	CATEGORY 5
PK33	Stool, matt chromed spring steel base	30.026	36.695	39.385

CATEGORY 4: AURA
 CATEGORY 5: GRACE, EMBRACE, RUSTIK, NATURAL

CANVAS COLOURS - SEE THE SURFACE SELECTION
 NATURAL

PK33

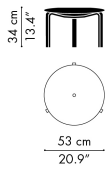



PK91™
POUL KJÆRHOLM 1961

01.2023

The PK91™ folding stool is available with a seat in a select range of leather types as well as in canvas. The base is made of satin brushed stainless steel.

MODEL	DESCRIPTION	CANVAS	CATEGORY 4	CATEGORY 5
PK91	Folding stool, satin brushed stainless steel base	29.204	35.663	37.965

CATEGORY 4: AURA
CATEGORY 5: GRACE, EMBRACE, RUSTIK, NATURAL

CANVAS COLOURS - SEE THE SURFACE SELECTION
NATURAL, BLACK

PK91

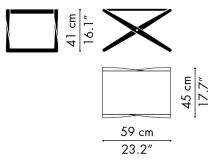



PK24™
POUL KJÆRHOLM 1965

01.2023

The PK24™ chaise longue is available in a select range of leather types or wicker. Both versions include a leather headrest. The base is made of satin brushed stainless spring steel.

MODEL	DESCRIPTION	CATEGORY 4	CATEGORY 5
PK24	Chaise longue, wicker, leather headrest, satin brushed stainless spring steel base	141.402	143.266
PK24	Chaise longue, leather, leather headrest, satin brushed stainless spring steel base	154.085	181.685

CATEGORY 4: AURA
CATEGORY 5: GRACE, EMBRACE, RUSTIK, NATURAL

PK24

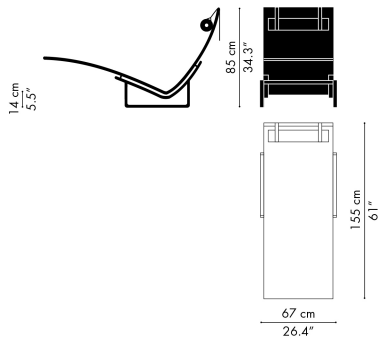



PK20™
POUL KJÆRHOLM 1968

01.2023

The PK20™ lounge chair is available in a select range of leather types or wicker. The leather version also includes a matching leather headrest. The base is made of matt chromed spring steel.

MODEL	DESCRIPTION	WICKER	CATEGORY 4	CATEGORY 5
PK20	Lounge chair, leather, leather headrest, matt chromed spring steel base		103.368	118.727
PK20	Lounge chair, wicker, matt chromed spring steel base	75.884		

CATEGORY 4: AURA
 CATEGORY 5: GRACE, EMBRACE, RUSTIK, NATURAL

PK20

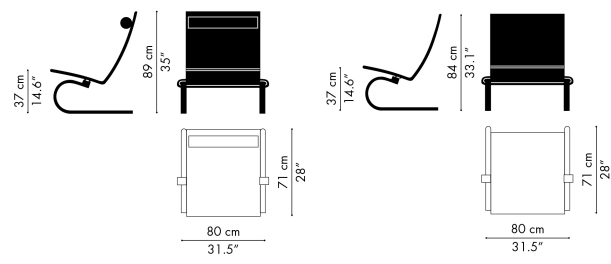

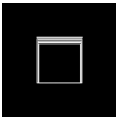

PK71™
POUL KJÆRHOLM 1957

01.2023

The PK71™ nesting table consists of three tables with a white or black acrylic tabletop. The bases are made of satin brushed stainless steel.

MODEL	DESCRIPTION	WHITE, BLACK	H/L/W
PK71	Nesting table, 3 sizes, satin brushed stainless steel base	19.273	28.5/28/28

PK71

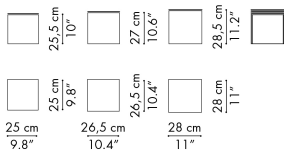



PK60™
POUL KJÆRHOLM 1952

01.2023

The PK60™ coffee table comes with a circular tempered glass tabletop and a three-legged base in pressure moulded veneer. The base is available in two different finishes: Oregon Pine or black coloured ash.

MODEL	DESCRIPTION	BLACK COLOURED ASH	OREGON PINE	H/Ø
PK60	Coffee table, pressure moulded veneer base	24.909	27.400	44/105

PK60

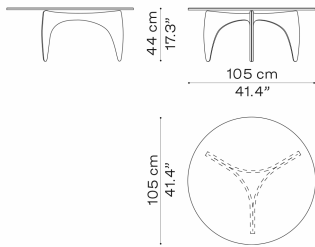



PK61™/PK61A™
POUL KJÆRHOLM 1956

01.2023

The PK61™ coffee table is available with different tabletops; slate, marble, granite and glass. PK61A™ is an enlarged version of PK61™ and is available with tabletops in marble, granite and glass. The base for both tables is made of satin brushed stainless steel.

MODEL	DESCRIPTION	SLATE	MARBLE	GRANITE	GLASS	FAUSKE MARBLE	H/L/W
PK61	Coffee table, satin brushed stainless steel base	36.239	36.239	36.239	42.336	42.336	32/80/80
PK61A	Coffee table, satin brushed stainless steel base		58.734	58.734	62.483	62.483	32/120/120

MARBLE COLOURS - SEE THE SURFACE SELECTION
 WHITE (ROLLED | 100), WHITE (HONED | 100), BEIGE (HONED | 140), GREY-BROWN (HONED | 150) AND BLACK (HONED | 200)

FAUSKE MARBLE - SEE THE SURFACE SELECTION
 GREY-WHITE (ROLLED)

NOTE
 THE MARBLE TABLETOPS ARE ALL UNIQUE WITH THEIR OWN PATTERN.

PK61

PK61A

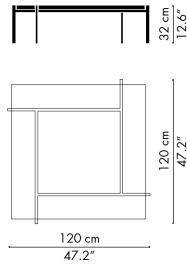
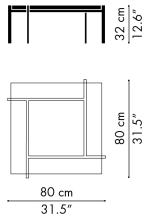



PK51™/PK55™
POUL KJÆRHOLM 1957

01.2023

The PK51™ and PK55™ tables come with a tabletop in ash veneer. The bases are made of satin brushed stainless steel.

MODEL	DESCRIPTION	ASH	H/L/W
PK51	Table, satin brushed stainless steel base	82.103	72/204/102
PK55	Table, satin brushed stainless steel base	63.630	72/180/90

PK51

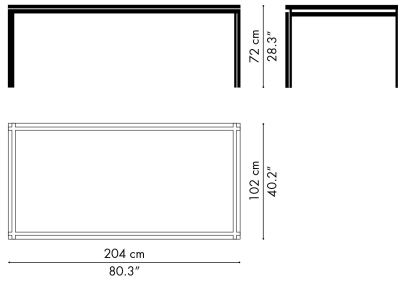

PK55

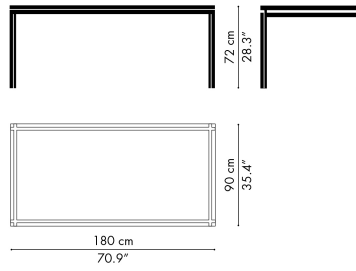



PK54™/PK54A™
POUL KJÆRHOLM 1963

01.2023

The PK54™ table is available with a tabletop in marble or granite. The square base is made of satin brushed stainless steel. The circular table top has an optional expansion ring consisting of six sections including a storage rack, both made of natural, untreated solid maple.

MODEL	DESCRIPTION	MARBLE	GRANITE	FAUSKE MARBLE	H/Ø
PK54	Table, satin brushed stainless steel base	97.474	97.474	116.969	69/140
PK54+PK54A	Table with PK54A expansion ring, satin brushed stainless steel base	196.928	196.928	216.423	69/210

MARBLE COLOURS - SEE THE SURFACE SELECTION
WHITE (ROLLED | 100), WHITE (HONED | 100), BEIGE (HONED | 140), GREY-BROWN (HONED | 150) AND BLACK (HONED | 200)

FAUSKE MARBLE - SEE THE SURFACE SELECTION
GREY-WHITE (ROLLED)

NOTE
THE MARBLE TABLETOPS ARE ALL UNIQUE WITH THEIR OWN PATTERN.

EXPANSION RING

MODEL	DESCRIPTION	SOLID MAPLE	
PK54A	Expansion ring, 6 sections, untreated solid maple, incl. storage rack	99.454	Ø210

PK54

PK54 +PK54A

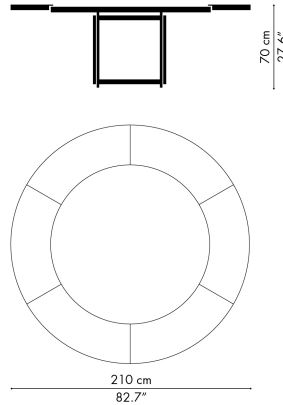
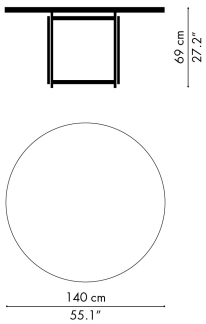



PK58™
POUL KJÆRHOLM 1963/2007

01.2023

The PK58™ table comes with a white polyester composite tabletop. The square base is made of anodised satin brushed aluminium.

MODEL	DESCRIPTION	WHITE	H/Ø
PK58	Table, anodised satin brushed aluminium base	47.485	71/130

PK58

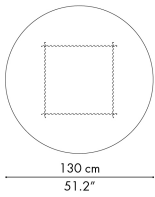
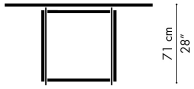



PK40™
POUL KJÆRHOLM 1980

01.2023

The PK40™ table comes with an upholstered tabletop in a select range of leather types. The base is made in satin brushed stainless steel.

MODEL	DESCRIPTION	CATEGORY 4	CATEGORY 5	H/L/W
PK40	Table, satin brushed stainless steel base	155.575	229.802	70/140/140

CATEGORY 4: AURA
CATEGORY 5: GRACE, EMBRACE, RUSTIK, NATURAL

PK40

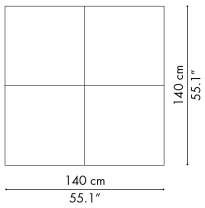
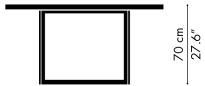



PK65™
POUL KJÆRHOLM 1979

01.2023

The PK65™ coffee table is available with a tabletop in slate, marble, granite and glass. The base is made of satin brushed stainless steel.

MODEL	DESCRIPTION	SLATE	MARBLE	GRANITE	GLASS	FAUSKE MARBLE	H/L/W
PK65	Coffee table, satin brushed stainless steel base	45.157	45.157	45.157	53.370	53.370	38/100/100

MARBLE COLOUR - SEE THE SURFACE SELECTION
 WHITE (ROLLED)

FAUSKE MARBLE - SEE THE SURFACE SELECTION
 GREY-WHITE (ROLLED)

NOTE
 THE MARBLE TABLETOPS ARE ALL UNIQUE WITH THEIR OWN PATTERN.

PK65

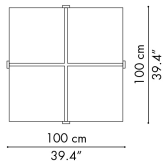



PK62™
POUL KJÆRHOLM 1968

01.2023

The PK62™ side table is available with a tabletop in slate, marble or granite. The base is made of satin brushed stainless steel.

MODEL	DESCRIPTION	SLATE	MARBLE	GRANITE	FAUSKE MARBLE	H/L/W
PK62	Side table, satin brushed stainless steel	20.525	20.525	20.525	24.630	17/80/27

MARBLE COLOUR - SEE THE SURFACE SELECTION
 WHITE (ROLLED)

FAUSKE MARBLE - SEE THE SURFACE SELECTION
 GREY-WHITE (ROLLED)

NOTE
 THE MARBLE TABLETOPS ARE ALL UNIQUE WITH THEIR OWN PATTERN.

PK62

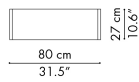



PK63™/PK63A™
POUL KJÆRHOLM 1968

01.2023

The PK63™ and PK63A™ coffee tables are available with a tabletop in slate, marble or granite. The base is made of satin brushed stainless steel.

MODEL	DESCRIPTION	SLATE	MARBLE	GRANITE	FAUSKE MARBLE	H/L/W
PK63	Coffee table, satin brushed stainless steel base	45.157	45.157	45.157	54.189	31/180/60
PK63A	Coffee table, satin brushed stainless steel base	36.949	36.949	36.949	44.338	31/120/60

MARBLE COLOUR - SEE THE SURFACE SELECTION
 WHITE (ROLLED)

FAUSKE MARBLE - SEE THE SURFACE SELECTION
 GREY-WHITE (ROLLED)

NOTE
 THE MARBLE TABLETOPS ARE ALL UNIQUE WITH THEIR OWN PATTERN.

PK63

PK63A

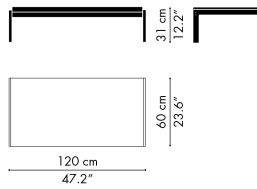
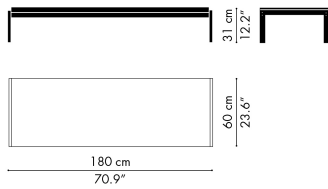

SURFACE SELECTION

SURFACE SELECTION

Colours and materials may vary from the images shown.

LEATHER

Please note that leather is a natural material with natural variation in colour and surface structure. The presence of scars and marks from bites etc. on the leather may occur and are characteristics of genuine leather.

CUSTOMER'S OWN LEATHER (COL)

Customers can supply their own leather. Prices excluding leather as well as leather requirements can be given on inquiry. Please note that only very few types of leather/qualities are suitable. Fritz Hansen retains the right to reject the qualities we find unsuitable.

SPECIAL LEATHER COLOURS

On inquiry and at a surcharge, special leather colours may be available for the models available with leather upholstery.

AURA



BLACK

BLACK BROWN

COGNAC

WALNUT

PK8™
PK9™
PK11™
PK20™
PK22™
PK24™
PK26™
PK31™
PK33™
PK40™
PK80™
PK81™
PK91™

CATEGORY: 4
Chrome-tanned, top-coated, strong full-grain and durable surface.
Fast to light.
Thickness 1.4-1.6 mm.

EMBRACE

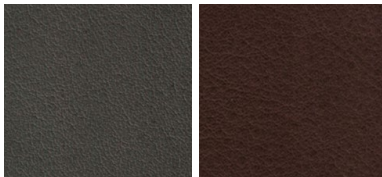

CONCRETE GREY

CHOCOLATE

PK9™
PK11™
PK20™
PK22™
PK24™
PK26™
PK31™
PK33™
PK40™
PK80™
PK81™
PK91™

CATEGORY: 5
Chrome-tanned, fully grained, extraordinary soft aniline with a special waxing giving a slightly 'oily' surface. Colour variations, visible natural markings e.g. Neck wrinkles.
Thickness 1.2-1.4 mm.

GRACE

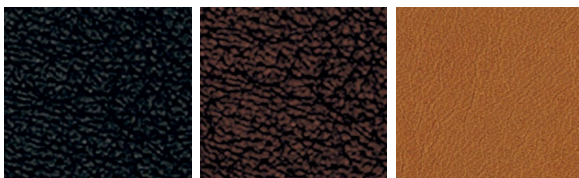

BLACK

DARK BROWN

WALNUT

PK8™
PK9™
PK11™
PK20™
PK22™
PK24™
PK26™
PK31™
PK33™
PK40™
PK80™
PK81™
PK91™

CATEGORY: 5
Vegetable and chrome-tanned, aniline, full-grain with light structure and light impregnation. Becomes lighter and patinated with use, visible natural markings.
Thickness 1.2-1.4 mm.

SURFACE SELECTION

Colours and materials may vary from the images shown.

LEATHER

NATURAL



NATURAL

PK9™
PK11™
PK20™
PK22™
PK24™
PK26™
PK31™
PK33™
PK40™
PK80™
PK81™
PK91™

CATEGORY: 5

Vegetable-tanned, chrome-free, natural leather, no colour or protective finish. Becomes darker and patinated with use, visible natural markings. Thickness 1.2-1.4 mm.

RUSTIK



RUSTIK

PK9™
PK11™
PK20™
PK22™
PK24™
PK26™
PK31™
PK33™
PK40™
PK80™
PK81™
PK91™

CATEGORY: 5

Vegetable-tanned, chrome-free, aniline, no protective finish, light impregnation, visible natural marks. Becomes lighter and patinated with use. Thickness 1.2-1.4 mm.

BUFFALO

Hides of water buffalo.

Chrome-tanned, very durable and high resistant surface. Nude surface with many visible natural markings, becomes lighter and patinated with use.

PK81™

NIGER

Exclusive goat skin.

Vegetable-tanned, fully grained pure aniline with structure.

Light impregnation, visible natural markings, becomes patinated with use.

PK26™

SURFACE SELECTION

Colours and materials may vary from the images shown.

LOUNGE AND SOFAS

FLAG HALYARD

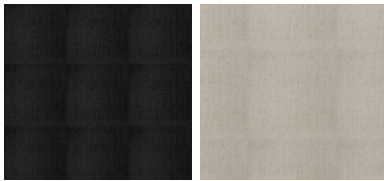

BLACK
100% FLAX WITH
POLYESTER CORE
PK25™

NATURAL
100% FLAX WITH
POLYESTER CORE
PK25™

CANVAS

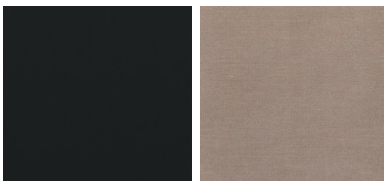

BLACK
100% COTTON
PK22™
PK91™

NATURAL
100% COTTON
PK22™
PK33™
PK80™
PK91™

WICKER



NATURAL
THICKNESS APPROX.
2.5 MM AND 4.0 MM

PK20™
PK22™
PK24™

VENEER

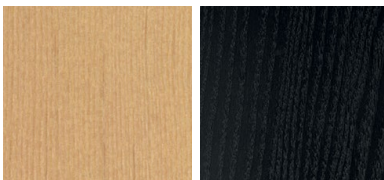

OREGON PINE
PKO A™

BLACK COLOURED ASH
PKO A™

SURFACE SELECTION

Colours and materials may vary from the images shown.

TABLES

GLASS



CLEAR
100

PK60™

CLEAR

PK61™
PK61A™
PK65™

MARBLE (HONED)

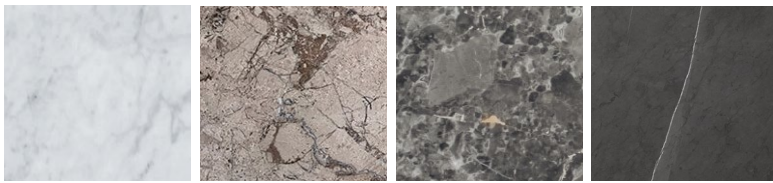

WHITE
100

PK54™
PK61™
PK61A™

BEIGE
140

PK54™
PK61™
PK61A™

GREY-BROWN
150

PK54™
PK61™
PK61A™

BLACK
200

PK54™
PK61™
PK61A™

MARBLE (ROLLED)

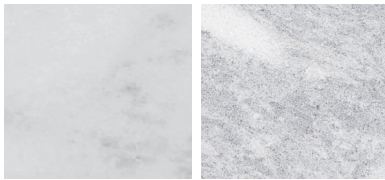

WHITE
100

PK54™
PK61™
PK61A™
PK62™
PK63™
PK63A™
PK65™

GREY-WHITE

PK54™
PK61™
PK61A™
PK62™
PK63™
PK63A™
PK65™

GRANITE

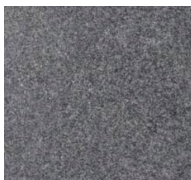

DARK

PK54™
PK61™
PK61A™
PK62™
PK63™
PK63A™
PK65™

SLATE

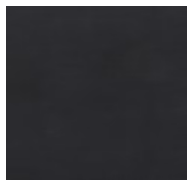

BLACK

PK61™
PK62™
PK63™
PK63A™
PK65™

SURFACE SELECTION

Colours and materials may vary from the images shown.

TABLES

ACRYLIC



WHITE
103
PK71™

BLACK
203
PK71™

POLYESTER COMPOSITE



WHITE
110
PK58™

VENEER



ASH
PK51™
PK55™

OREGON PINE
PK60™

BLACK COLOURED ASH
PK60™

SOLID WOOD

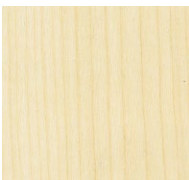

MAPLE
PK54A™
(EXPANSION RING)