

FLEXIBILITY  
DELIVERED  
WITH PASSION



# SENAB

## Färgmarkeringar och/eller symboler för hållbara alternativ i prislistan:

### Mörkgrön markering eller symbol

Miljömärkt produkt – Möbler där hela den sammansatta varan har en typ 1 miljömärkning enligt ISO 14024 med Svanen, Möbelfakta, EU Ecolabel eller annan likvärdig märkning.

### Ljusgrön markering eller symbol

Hållbarhetsmärkt produkt eller beståndsdel – Möbler där hela eller delar av den sammansatta varan är hållbarhetsmärkt, exempelvis med FSC, EU Ecolabel eller OEKO-TEX®. Leverantören ska kunna ge mer detaljerad information om vilka delar eller variationer som är hållbarhetsmärka vid begäran.

### Orange markering eller symbol

Klimatberäknad produkt – Produkt med dokumenterad miljövarudeklaration (EPD) enligt ISO 14025.

### Lila markering eller symbol

Produkt med återvunnet eller förnybart material (enligt definitionerna i ISO 14021). Leverantören ska kunna ge information om andel (%) återvunnet och/eller förnybart (biobaserat) vid begäran. Märkning av återvinningsbart material utgår.

### Blå markering eller symbol

Demonterbar produkt – Produkt som är demonterbar till olika komponenter och beståndsdelar som i första hand möjliggör återbruk och i andra hand materialåtervinning när produkten nått sin fulla livslängd. Produkten ska vara designad för renovering, det vill säga att det ska vara enkelt att reparera och byta ut moduler, komponenter och beståndsdelar som slits över tid. Exempelvis ska ytskikt, som bordsskivor, textil och stoppning kunna tas isär, avlägsnas och ersättas med hjälp av vanligt förekommande manuella verktyg, ej specialverktyg. Enklare reparationer och utbytesarbeten ska kunna utföras av en lekman. Om det krävs fackmanakunskap för mer avancerade arbeten ska det framgå av anvisningarna som leverantören ska kunna ge vid begäran. Anvisningarna ska innehålla en sprängskiss, steg för steg beskrivning inklusive vilka verktyg som krävs samt hur möbelns ingående delar bör källsorteras.



## Table of Content

### Chairs

40/4	4
Side chair	4
Side chair - upholstered	5
Arm chair	6
Arm chair - upholstered	7
Swivel	8
Swivel - upholstered	9
Bar and Lounge	10
Metal and Wood	11
SixE	12
4-leg	12
4-leg on castors	13
Sled	14
Barstool	15
Swivel	16
Learn	17
AS100	18
The Tongue	19
Munkegaard	20
Accessories for chairs	21
Notes for chairs	28
<hr/>	
Upholstery collection	30



## Table of Content

Tables	
Moveo	32
Training	32
Meeting	33
Conference, modular	34
Conference, stand alone	35
Modesty panel	36
Simpla	37
Tables	37
Modesty panel	39
Tempest	40
Flip top	40
Flip top café	41
Flip top bar	42
Fold	43
Fix	44
Fix bar	45
Fix café and lounge	46
Modesty panel	47
Tutor	49
Usu	50
AS table series	51
AS400	51
AS500	52
Other accessories for tables	53
Notes for tables	56
Finish overview	58
Sales Terms	63
Warranty	67

# 40/4 side chair - polyamide

By David Rowland

Most people see the 40/4 as a pioneering design that has stood the test of time. We like to think of it as a legacy that continues to move you in new ways.

- 10 year warranty
- Stacks 40 chairs on a dolly
- EN 15373 / ANSI/BIFMA X5.1 – N7.1
- FSC/PEFC certified
- ISO 14025 EPD
- GreenTag<sup>Cert™</sup>
- Health Product Declaration (HPD)
- **Quick ship - LINK**

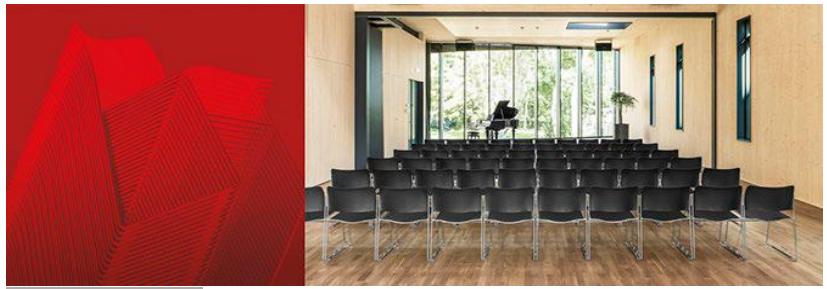

		POLYAMIDE (DPA)	
STANDARD FRAME COLOURS		PA200 ●	PA100 ●
 B1 B6 B7 B9 B10 B30		PA300 ○	PA110 ●
RAL K5 colours available at customer request		PA250 ●	PA260 ●
		PA320 ●	PA360 ●
		PA380 ●	PA370 ●
		SEK	SEK
Non linking (RA)	6,5 kg		
		2772	2984
Brace linking (BA)	6,6 kg		
		3156	3368
Eye Hook linking (EA)	6,6kg		
		3163	3375
Dining height (DA)*	6,5 kg		
		3032	3244
*Different seat angle compared to regular chair			
Side chair outdoor (DOARA)	6,5 kg		
		4152	4364

Felt glides	+118	SEK
Fee per RAL K5 colour for frames (for one colour if below 200 pcs)	+2400	SEK

Price list 2023 - SEK excl. V.A.T. - Version 1.2

# 40/4 side chair upholstered

By David Rowland

Most people see the 40/4 as a pioneering design that has stood the test of time. We like to think of it as a legacy that continues to move you in new ways.

- 10 year warranty
- Stacks 25 chairs on a dolly
- EN 16139 / Ansi/Bifma X5.1
- FSC/PEFC certified
- ISO 14025 EPD
- GreenTag<sup>Cert™</sup>
- **Quick ship - LINK**



## STANDARD FRAME COLOURS



RAL K5 colours available at customer request

Non linking (RA) 6,3 kg

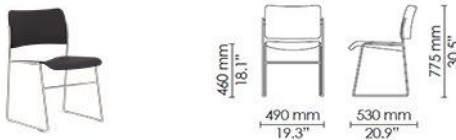

Brace linking (BA) 6,5 kg

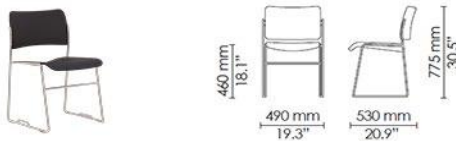

Eye Hook linking (EA) 6,5 kg

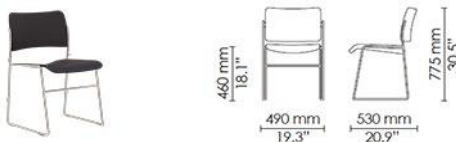

Dining height (DA)\* 6,3 kg

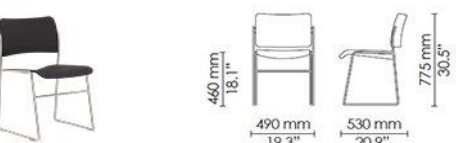

\*Different seat angle compared to regular chair

GROUP	SEAT UPHOLSTERED		
	POLYAMIDE (DSA)		
	PA200	PA100	PA370
	PA300	PA110	FULLY UPHOLSTERED (DUA)
		PA250	
		PA260	
		PA320	
		PA360	
		PA380	
		PA370	
	SEK	SEK	SEK
<b>COM</b>	3553	3695	4035
<b>1</b>	3774	3916	4347
<b>2</b>	4074	4216	4777
<b>3</b>	4360	4502	5193
<b>4</b>	4789	4931	5805
<b>5</b>	4933	5075	6013
<b>COL</b>	4451	4593	5323
<b>LUBL</b>	4789	4931	5805
<b>LUCL</b>	5375	5517	6638
<b>LSL</b>	6286	6428	7939
<b>COM</b>	3943	4085	4425
<b>1</b>	4164	4306	4737
<b>2</b>	4464	4606	5167
<b>3</b>	4750	4892	5583
<b>4</b>	5179	5321	6195
<b>5</b>	5323	5465	6403
<b>COL</b>	4841	4983	5713
<b>LUBL</b>	5179	5321	6195
<b>LUCL</b>	5765	5907	7028
<b>LSL</b>	6676	6818	8329
<b>COM</b>	3943	4085	4425
<b>1</b>	4164	4306	4737
<b>2</b>	4464	4606	5167
<b>3</b>	4750	4892	5583
<b>4</b>	5179	5321	6195
<b>5</b>	5323	5465	6403
<b>COL</b>	4841	4983	5713
<b>LUBL</b>	5179	5321	6195
<b>LUCL</b>	5765	5907	7028
<b>LSL</b>	6676	6818	8329
<b>COM</b>	3813	3955	4295
<b>1</b>	4034	4176	4607
<b>2</b>	4334	4476	5037
<b>3</b>	4620	4762	5453
<b>4</b>	5049	5191	6065
<b>5</b>	5193	5335	6273
<b>COL</b>	4711	4853	5583
<b>LUBL</b>	5049	5191	6065
<b>LUCL</b>	5635	5777	6898
<b>LSL</b>	6546	6688	8199

Price list 2023 - SEK excl. V.A.T. - Version 1.2

Felt glides +118 SEK

Fee per RAL K5 colour for frames (for one colour if below 200 pcs) +2400 SEK

# 40/4 armchair - polyamide

By David Rowland

Most people see the 40/4 as a pioneering design that has stood the test of time. We like to think of it as a legacy that continues to move you in new ways.

- 10 year warranty
- Stacks 40 chairs on a dolly
- EN 15373 / ANSI/BIFMA X5.1 – N7.1
- FSC/PEFC certified
- ISO 14025 EPD
- GreenTag<sup>Cert™</sup>
- 27% recycled plastic
- **Quick ship - LINK**

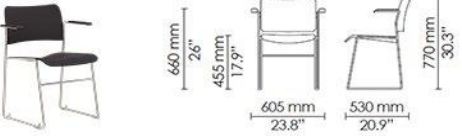
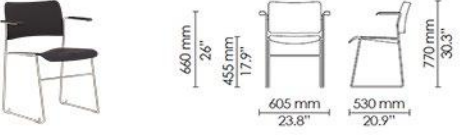
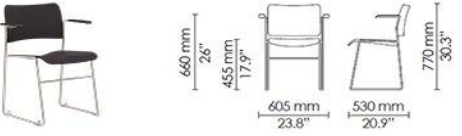
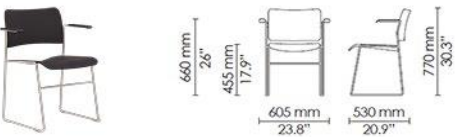

		POLYAMIDE (DPB)	
<b>STANDARD FRAME COLOURS</b>  B1 B6 B7 B9 B10 B30  RAL K5 colours available at customer request		PA200 ● PA300 ○	PA100 ● PA110 ● PA250 ● PA260 ● PA320 ● PA360 ● PA380 ● PA370 ●
Non linking (RA) 7,7 kg  		3839	4047
Dining height (DA)* 7,7 kg  		4100	4308
*Different seat angle compared to regular chair Armlinking (J) 7,8 kg  		4464	4672
Armchair outdoor (DOBRA) 7,7 kg  		5219	5431

Price list 2023 - SEK excl. V.A.T. - Version 1.2

Felt glides	+118 SEK
Table surface protection	+120 SEK
Fee per RAL K5 colour for frames (for one colour if below 200 pcs)	+2400 SEK

# 40/4 armchair upholstered

By David Rowland

Most people see the 40/4 as a pioneering design that has stood the test of time. We like to think of it as a legacy that continues to move you in new ways.

- 10 year warranty
- Stacks 25 chairs on a dolly
- EN 15373 / ANSI/BIFMA X5.1 – N7.1
- FSC/PEFC certified
- ISO 14025 EPD
- GreenTag<sup>Cert™</sup>
- **Quick ship - LINK**



## STANDARD FRAME COLOURS

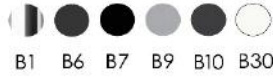

RAL K5 colours available at customer request

Non linking (RA) 7,6 kg



Dining height (DA)\* 7,6 kg

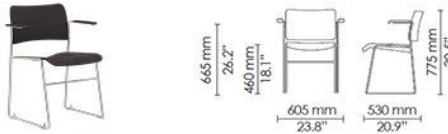

\*Different seat angle compared to regular chair

Armlinking (J) 7,7 kg

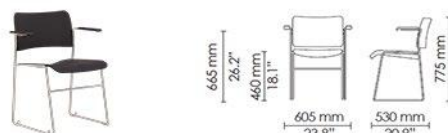

GROUP	SEAT UPHOLSTERED		FULLY UPHOLSTERED		
	POLYAMIDE (DSB)		UPHOLSTERED (DUB)		
	PA200 PA300	PA100 PA110 PA250 PA260 PA320 PA360 PA380 PA370	BLACK POLYAMIDE ARMREST	BLACK STAINED VENEER ARMREST	UPH. ARMRESTS
	SEK	SEK	SEK	SEK	SEK
<b>COM</b>	4620	4763	5102	5527	5531
<b>1</b>	4841	4984	5414	5839	5974
<b>2</b>	5141	5284	5844	6269	6495
<b>3</b>	5427	5570	6260	6685	6989
<b>4</b>	5856	5999	6872	7297	7666
<b>5</b>	6000	6143	7080	7505	7991
<b>COL</b>	5518	5661	6390	6815	7054
<b>LUBL</b>	5856	5999	6872	7297	7666
<b>LUCL</b>	6442	6585	7705	8130	8850
<b>LSL</b>	7353	7496	9006	9431	10255
<b>COM</b>	4881	5024	5362	5787	5791
<b>1</b>	5102	5245	5674	6099	6234
<b>2</b>	5402	5545	6104	6529	6755
<b>3</b>	5688	5831	6520	6945	7249
<b>4</b>	6117	6260	7132	7557	7926
<b>5</b>	6261	6404	7340	7765	8251
<b>COL</b>	5779	5922	6650	7075	7314
<b>LUBL</b>	6117	6260	7132	7557	7926
<b>LUCL</b>	6703	6846	7965	8390	9110
<b>LSL</b>	7614	7757	9266	9691	10515
<b>COM</b>	5245	5388	5727	6152	6156
<b>1</b>	5466	5609	6039	6464	6599
<b>2</b>	5766	5909	6469	6894	7120
<b>3</b>	6052	6195	6885	7310	7614
<b>4</b>	6481	6624	7497	7922	8291
<b>5</b>	6625	6768	7705	8130	8616
<b>COL</b>	6143	6286	7015	7440	7679
<b>LUBL</b>	6481	6624	7497	7922	8291
<b>LUCL</b>	7067	7210	8330	8755	9475
<b>LSL</b>	7978	8121	9631	10056	10880

Price list 2023 - SEK excl. V.A.T. - Version 1.2

Felt glides	+118	SEK
Table surface protection	+120	SEK
Fee per RAL K5 colour for frames (for one colour if below 200 pcs)	+2400	SEK
Fee per RAL K5 colour for veneer (for one colour if below 200 pcs)	+1100	SEK



# 40/4 swivel - polyamide

By David Rowland

Most people see the 40/4 as a pioneering design that has stood the test of time. We like to think of it as a legacy that continues to move you in new ways.

- 10 year warranty
- Castors or glides available
- Height adjustable
- Soft lane castor as an option
- FSC/PEFC certified
- GreenTag<sup>Cert™</sup>
- 39% recycled plastic



STANDARD FRAME COLOURS		POLYAMIDE (DP)	
<p>B1 B6 B7 B9 B10 B30</p>		PA200 ● PA100 ● PA300 ○ PA110 ● PA250 ● PA260 ● PA320 ● PA360 ● PA380 ● PA370 ● SEK SEK	
RAL K5 colours available at customer request			
Side chair (DPESS)	11,6 kg		
		5180	5392
Armchair (DPFSA)	12,4 kg		
		6260	6468

Price list 2023 - SEK excl. V.A.T. - Version 1.2

Soft lane castors	+118	SEK
Fee per RAL K5 colour for frames (for one colour if below 200 pcs)	+2400	SEK

# 40/4 swivel upholstered

By David Rowland

Most people see the 40/4 as a pioneering design that has stood the test of time. We like to think of it as a legacy that continues to move you in new ways.

- 10 year warranty
- Castors or glides available
- Height adjustable
- Soft lane castor as an option
- FSC/PEFC certified
- ISO 14025 EPD
- GreenTag<sup>Cert™</sup>

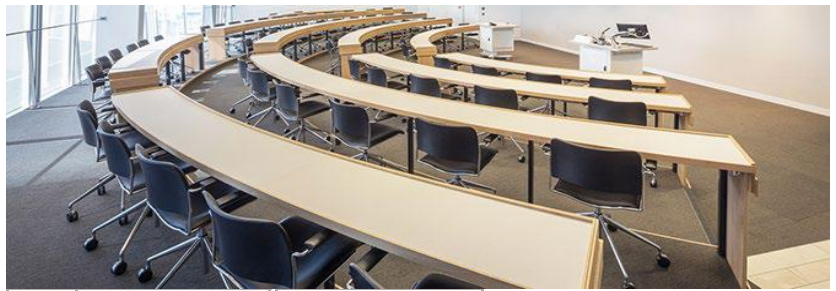

## STANDARD FRAME COLOURS



RAL K5 colours available at customer request

## Side chair (DUSS)

11,4 kg

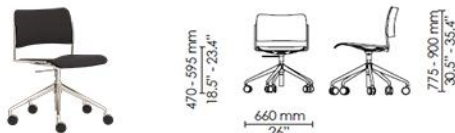

## Armchair (DUFSA)

12,2 kg

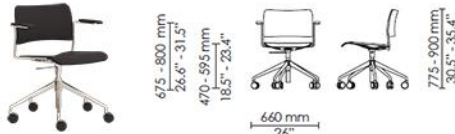

GROUP	SEAT UPHOLSTERED		FULLY UPHOLSTERED (DU)		
	POLYAMIDE (DS)		BLACK POLYAMIDE ARMREST	BLACK STAINED VENEER ARMREST	W-W/O UPH. ARM
	PA200	PA100	SEK	SEK	SEK
	PA300	PA110			
		PA250			
		PA260			
		PA320			
		PA360			
		PA380			
		PA370			
	SEK	SEK			
<b>COM</b>	5961	6103	N/A	N/A	6442
<b>1</b>	6182	6324	N/A	N/A	6754
<b>2</b>	6482	6624	N/A	N/A	7184
<b>3</b>	6768	6910	N/A	N/A	7600
<b>4</b>	7197	7339	N/A	N/A	8212
<b>5</b>	7341	7483	N/A	N/A	8420
<b>COL</b>	6859	7001	N/A	N/A	7730
<b>LUBL</b>	7197	7339	N/A	N/A	8212
<b>LUCL</b>	7783	7925	N/A	N/A	9045
<b>LSL</b>	8694	8836	N/A	N/A	10346
<b>COM</b>	7028	7171	7510	7935	7939
<b>1</b>	7249	7392	7822	8247	8382
<b>2</b>	7549	7692	8252	8677	8903
<b>3</b>	7835	7978	8668	9093	9397
<b>4</b>	8264	8407	9280	9705	10074
<b>5</b>	8408	8551	9488	9913	10399
<b>COL</b>	7926	8069	8798	9223	9462
<b>LUBL</b>	8264	8407	9280	9705	10074
<b>LUCL</b>	8850	8993	10113	10538	11258
<b>LSL</b>	9761	9904	11414	11839	12663

Price list 2023 - SEK excl. V.A.T. - Version 1.2

Soft lane castors	+118	SEK
Fee per RAL K5 colour for frames (for one colour if below 200 pcs)	+2400	SEK
Fee per RAL K5 colour for veneer (for one colour if below 200 pcs)	+1100	SEK

# 40/4 barstool and lounge chair

By David Rowland

Most people see the 40/4 as a pioneering design that has stood the test of time. We like to think of it as a legacy that continues to move you in new ways.

- 10 year warranty
- Stacks 10 barstools
- Stacks 20 lounge chairs
- EN 15373 / ANSI/BIFMA X5.1
- FSC/PEFC certified
- ISO 14025 EPD
- GreenTag<sup>CertTM</sup>



	POLYAMIDE		FULLY UPHOLSTERED	
STANDARD FRAME COLOURS	PA200 ●	PA100 ●	GROUP	PRICE
	PA300 ●	PA110 ●		
RAL K5 colours available at customer request	PA250 ●	PA260 ●		
	PA320 ●	PA360 ●		
	PA380 ●	PA370 ●		
	SEK	SEK		SEK
Lounge chair (DVdra) 6 kg	N/A	N/A	COM	5596
			1	5908
			2	6338
			3	6754
			4	7366
			5	7574
			COL	6884
			LUBL	7366
			LUCL	8199
			LSL	9500
Barstool (DPCAa) 10,4 kg	5115	5327	COM	6377
			1	6689
			2	7119
			3	7535
			4	8147
			5	8355
			COL	7665
			LUBL	8147
			LUCL	8980
			LSL	10281
Barstool counter height (DPCCA) 9,2 kg	5115	5327	COM	6377
			1	6689
			2	7119
			3	7535
			4	8147
			5	8355
			COL	7665
			LUBL	8147
			LUCL	8980
			LSL	10281
Barstool outdoor (DOCCA) 10,4 kg	6494	6706		

Price list 2023 - SEK excl. V.A.T. - Version 1.2

Felt glides	+118	SEK
Fee per RAL K5 colour for frames (for one colour if below 200 pcs)	+2400	SEK
Fee per RAL K5 colour for veneer (for one colour if below 200 pcs)	+1100	SEK

# 40/4 metal

By David Rowland

Most people see the 40/4 as a pioneering design that has stood the test of time. The 40/4 wood frame is an alternative to the original chair with its iconic steel rod sled frame

- 10 year warranty
- Stacks 25 chairs with wood frame
- Stacks 40 chairs in metal
- Wood frame also with seat upholstered
- EN 16139 (wood frame)
- FSC/PEFC certified
- GreenTag<sup>Cert™</sup>



		METAL (DMA)
		ME200 ME300 ME110
		SEK
Metal non linking (DMA-N)	8,5 kg	
		4063
Metal w/ linking (DMA-Y)	8,6 kg	
		4269

Price list 2023 - SEK excl. V.A.T. - Version 1.2

Felt glides	+118	SEK
Fee per RAL K5 colour for frames (for one colour if below 200 pcs)	+2400	SEK







# SixE 4-leg

By PearsonLloyd

No matter how you look at SixE, it presents itself as a perfectly bold move – bending the rules of how comfortable a simple polypropylene shell chair can be.

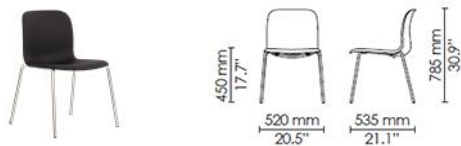
- 10 year warranty
- SixE stacks up to 25 chairs on a dolly
- GreenTag<sup>Cert™</sup>
- **Quick ship - LINK**
- Shells from recycled plastic available

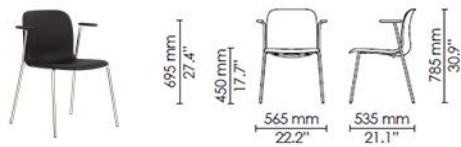

Standard frame colours:  B1 B6 B7 B9 B10 B30 Choose matching frame and shell colour without additional costs: 	POLYPROPYLENE (EPAMA/EPBMA)		UPHOLSTERY					
	PP200 ●	PP100 ● PP300 ● PP310 ● PP270 ● PP120 ● PP340 ● PP350 ●	GROUP	SEAT UPH.		FULLY UPH.		
				BLACK (EFA/EFB)	COLOUR (EFA/EFB)	NO ARM (EUA)	BLACK ARM (EUB)	
RAL K5 colours available at customer request	SEK	SEK		SEK	SEK	SEK	SEK	
Sidechair (EPAMA) 5 kg		2318	2579	COM	3570	3831	5849	N/A
				1	3747	4008	6380	N/A
				2	3924	4185	6911	N/A
				3	4066	4327	7336	N/A
				4	4302	4563	8045	N/A
				5	4526	4787	8718	N/A
				COL	4184	4445	N/A	N/A
				LUBL	4302	4563	N/A	N/A
				LUCL	4857	5118	N/A	N/A
				LSL	5459	5720	N/A	N/A
				COM	3993	4254	6272	N/A
	1	4170	4431	6803	N/A			
	2	4347	4608	7334	N/A			
	3	4489	4750	7759	N/A			
	4	4725	4986	8468	N/A			
	5	4949	5210	9141	N/A			
	COL	4607	4868	N/A	N/A			
LUBL	4725	4986	N/A	N/A				
LUCL	5280	5541	N/A	N/A				
LSL	5882	6143	N/A	N/A				
	COM	4313	4570	N/A	6531			
	1	4490	4747	N/A	7062			
	2	4667	4924	N/A	7593			
	3	4809	5066	N/A	8018			
	4	5045	5302	N/A	8727			
	5	5269	5526	N/A	9400			
	COL	4927	5184	N/A	N/A			
	LUBL	5045	5302	N/A	N/A			
	LUCL	5600	5857	N/A	N/A			
	LSL	6202	6459	N/A	N/A			
	COM	4436	4693	N/A	6654			
1	4613	4870	N/A	7185				
2	4790	5047	N/A	7716				
3	4932	5189	N/A	8141				
4	5168	5425	N/A	8850				
5	5392	5649	N/A	9523				
COL	5050	5307	N/A	N/A				
LUBL	5168	5425	N/A	N/A				
LUCL	5723	5980	N/A	N/A				
LSL	6325	6582	N/A	N/A				

Price list 2023 - SEK excl. V.A.T. - Version 1.2

Felt glides +123 SEK

Fee per RAL K5 colour for frames (for one colour if below 200 pcs) +2400 SEK





# SixE 4-leg on castors

By PearsonLloyd

No matter how you look at SixE, it presents itself as a perfectly bold move – bending the rules of how comfortable a simple polypropylene shell chair can be.

- 10 year warranty
- SixE stacks up to 15 chairs on a dolly
- GreenTag<sup>Cert™</sup>
- Shells from recycled plastic available



Standard frame colours:  B1 B6 B7 B9 B10 B30 Choose matching frame and shell colour without additional costs: 	POLYPROPYLENE (EPASB/EPBSD)		UPHOLSTERY				
	PP200 ●	PP100 ● PP300 ○ PP310 ● PP270 ● PP120 ● PP340 ● PP350 ●	GROUP	SEAT UPH.		FULLY UPH.	
				BLACK (EFA/EFB)	COLOUR (EFA/EFB)	NO ARM (EUA)	BLACK ARM (EUB)
RAL K5 colours available at customer request	SEK	SEK		SEK	SEK	SEK	SEK
Sidechair (EPASB) 5,2 kg 	3600	3861	<b>COM</b>	4968	5229	7131	N/A
			<b>1</b>	5145	5406	7662	N/A
			<b>2</b>	5322	5583	8193	N/A
			<b>3</b>	5464	5725	8618	N/A
			<b>4</b>	5700	5961	9327	N/A
			<b>5</b>	5924	6185	10000	N/A
			<b>COL</b>	5582	5843	N/A	N/A
			<b>LUBL</b>	5700	5961	N/A	N/A
			<b>LUCL</b>	6255	6516	N/A	N/A
			<b>LSL</b>	6857	7118	N/A	N/A
Armchair (EPBSD) 6,1 kg 	4281	4540	<b>COM</b>	5712	5969	N/A	7812
			<b>1</b>	5889	6146	N/A	8343
			<b>2</b>	6066	6323	N/A	8874
			<b>3</b>	6208	6465	N/A	9299
			<b>4</b>	6444	6701	N/A	10008
			<b>5</b>	6668	6925	N/A	10681
			<b>COL</b>	6326	6583	N/A	N/A
			<b>LUBL</b>	6444	6701	N/A	N/A
			<b>LUCL</b>	6999	7256	N/A	N/A
			<b>LSL</b>	7601	7858	N/A	N/A

Price list 2023 - SEK excl. V.A.T. - Version 1.2

Soft lane castors +123 SEK

Fee per RAL K5 colour for frames (for one colour if below 200 pcs) +2400 SEK

# SixE sled





By PearsonLloyd

No matter how you look at SixE, it presents itself as a perfectly bold move – bending the rules of how comfortable a simple polypropylene shell chair can be.

- 10 year warranty
- SixE stacks up to 25 chairs on a dolly
- GreenTag<sup>Cert™</sup>
- **Quick ship - LINK**
- Shells from recycled plastic available

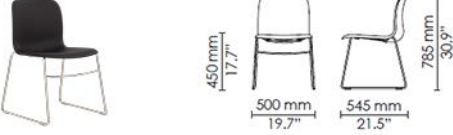

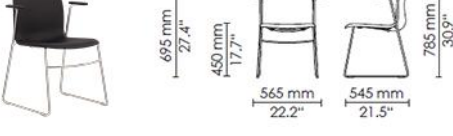
Photo: Steve Hall / Architect: Eastlake Studio

Standard frame colours:  RAL K5 colours available at customer request	POLYPROPYLENE (EPA/EPB)		UPHOLSTERY				
	SEK	SEK	GROUP	SEAT UPH.		FULLY UPH.	
				BLACK (EFA/ EFB)	COLOUR (EFA/ EFB)	NO ARM (EUA)	BLACK ARM (EUB)
<b>Sidechair (EPARB)</b> 6 kg 	2822	3083	COM	4120	4381	6354	N/A
<b>Sidechair with bracelinking (EPABB)</b> 6.2 kg 	3245	3506	COM	4581	4842	6776	N/A
<b>Armchair (EPBRB)</b> 7.3 kg 	3504	3763	COM	4864	5121	N/A	7035
<b>Armchair with armlinking (EPBRB-Y)</b> 7.3 kg 	3627	3886	COM	4987	5244	N/A	7158
			1	4297	4558	6885	N/A
			2	4474	4735	7416	N/A
			3	4616	4877	7841	N/A
			4	4852	5113	8550	N/A
			5	5076	5337	9223	N/A
			COL	4734	4995	N/A	N/A
			LUBL	4852	5113	N/A	N/A
			LUCL	5407	5668	N/A	N/A
			LSL	6009	6270	N/A	N/A
			COM	4581	4842	6776	N/A
			1	4758	5019	7307	N/A
			2	4935	5196	7838	N/A
			3	5077	5338	8263	N/A
			4	5313	5574	8972	N/A
			5	5537	5798	9645	N/A
			COL	5195	5456	N/A	N/A
			LUBL	5313	5574	N/A	N/A
			LUCL	5868	6129	N/A	N/A
			LSL	6470	6731	N/A	N/A
			COM	5041	5298	N/A	7566
			2	5218	5475	N/A	8097
			3	5360	5617	N/A	8522
			4	5596	5853	N/A	9231
			5	5820	6077	N/A	9904
			COL	5478	5735	N/A	N/A
			LUBL	5596	5853	N/A	N/A
			LUCL	6151	6408	N/A	N/A
			LSL	6753	7010	N/A	N/A
			COM	5164	5421	N/A	7689
			2	5341	5598	N/A	8220
			3	5483	5740	N/A	8645
			4	5719	5976	N/A	9354
			5	5943	6200	N/A	10027
			COL	5601	5858	N/A	N/A
			LUBL	5719	5976	N/A	N/A
			LUCL	6274	6531	N/A	N/A
			LSL	6876	7133	N/A	N/A

Price list 2023 - SEK excl. V.A.T. - Version 1.2

Felt glides	+123	SEK
Fee per RAL K5 colour for frames (for one colour if below 200 pcs)	+2400	SEK

# SixE barstool

By PearsonLloyd

No matter how you look at SixE, it presents itself as a perfectly bold move – bending the rules of how comfortable a simple polypropylene shell chair can be.

- 10 year warranty
- SixE stacks up to 10 chairs on a dolly
- GreenTag<sup>Cert™</sup>
- Shells from recycled plastic available

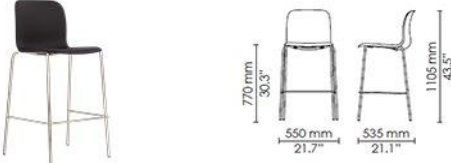
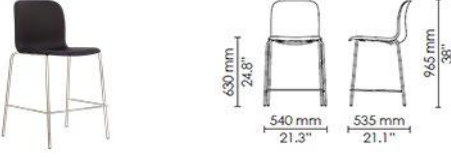
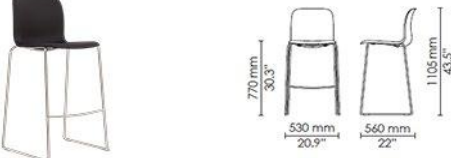

Standard frame colours:  RAL K5 colours available at customer request	POLYPROPYLENE (EPC)		UPHOLSTERY			
	SEK	SEK	GROUP	SEAT UPH.		FULLY UPH. (EUC)
				BLACK (EFC)	COLOUR (EFC)	
Barstool 4 Leg (EPCAO) 7,3 kg 	4186	4447				
Barstool 4 Leg counter height (EPCAP) 5,2 kg 	4186	4447				
Barstool Sled frame (EPCAM) 9,5 kg 	4690	4951				
			<b>COM</b>	SEK	SEK	SEK
			<b>1</b>	5607	5868	7717
			<b>2</b>	5784	6045	8248
			<b>3</b>	5961	6222	8779
			<b>4</b>	6103	6364	9204
			<b>5</b>	6339	6600	9913
			<b>COL</b>	6563	6824	10586
			<b>LUBL</b>	6221	6482	N/A
			<b>LUCL</b>	6339	6600	N/A
			<b>LSL</b>	6894	7155	N/A
			<b>COM</b>	7496	7757	N/A
			<b>1</b>	5607	5868	7717
			<b>2</b>	5784	6045	8248
			<b>3</b>	5961	6222	8779
			<b>4</b>	6103	6364	9204
			<b>5</b>	6339	6600	9913
			<b>COL</b>	6563	6824	10586
			<b>LUBL</b>	6221	6482	N/A
			<b>LUCL</b>	6339	6600	N/A
			<b>LSL</b>	6894	7155	N/A
			<b>COM</b>	7496	7757	N/A
			<b>1</b>	6158	6419	8221
			<b>2</b>	6335	6596	8752
			<b>3</b>	6512	6773	9283
			<b>4</b>	6654	6915	9708
			<b>5</b>	6890	7151	10417
			<b>COL</b>	7114	7375	11090
			<b>LUBL</b>	6772	7033	N/A
			<b>LUCL</b>	6890	7151	N/A
			<b>LSL</b>	7445	7706	N/A
			<b>COM</b>	8047	8308	N/A

Price list 2023 - SEK excl. V.A.T. - Version 1.2

Felt glides +123 SEK

Fee per RAL K5 colour for frames (for one colour if below 200 pcs) +2400 SEK



# SixE swivel

By PearsonLloyd

No matter how you look at SixE, it presents itself as a perfectly bold move. – bending the rules of how comfortable a simple polypropylene shell chair can be.

- 10 year warranty
- Design for Disassembly
- GreenTag<sup>Cert™</sup>
- Shells from recycled plastic available



Standard frame colours: ● B10 BAIN - HOWE Grey	POLYPROPYLENE (EPEES/EPFES)		UPHOLSTERY			
	SEK	SEK	GROUP	SEAT UPH.		FULLY UPH. (EFSES/EFTES)
				BLACK (EPO/ EPP)	COLOUR (EPO/ EPP)	
<p>Sidechair 7,2 kg</p> <p>Armchair 8,3 kg</p>	PP200 ● PP100 ● PP300 ○ PP310 ● PP270 ● PP120 ● PP340 ● PP350 ●  RECYCLED PP100 ●					
				SEK	SEK	SEK
	3272	3533		4611	4872	6803
			COM	4788	5049	7334
			1	4965	5226	7865
			2	5107	5368	8290
			3	5343	5604	8999
			4	5567	5828	9672
			5	5225	5486	N/A
			COL	5343	5604	N/A
			LUBL	5898	6159	N/A
			LUCL	6500	6761	N/A
			LSL	5355	5612	7485
			COM	5532	5789	8016
			1	5709	5966	8547
			2	5851	6108	8972
			3	6087	6344	9681
			4	6311	6568	10354
			5	5969	6226	N/A
			COL	6087	6344	N/A
			LUBL	6642	6899	N/A
			LUCL	7244	7501	N/A
			LSL			

Price list 2023 - SEK excl. V.A.T. - Version 1.2

Soft lane castors +123 SEK



# SixE Learn

By PearsonLloyd

No matter how you look at SixE, it presents itself as a perfectly bold move – bending the rules of how comfortable a simple polypropylene shell chair can be.

- 5 year warranty
- Design for Disassembly
- Chair for active learning environments, classrooms and higher education
- GreenTag<sup>Cert™</sup>
- Shells from recycled plastic available



Standard frame colours: B10 BAIN - HOWE Grey	POLYPROPYLENE (EPO/EPP)		UPHOLSTERY			
	PP200 ●	PP100 ● PP300 ○ PP310 ● PP270 ● PP120 ● PP340 ● PP350 ●  RECYCLED PP100 ●	GROUP	SEAT UPH.		FULLY UPH. (EFQ/ EFR)
				BLACK (EFO/ EFP)	COLOUR (EFO/ EFP)	
Learn side chair  11,7 kg	6204	6422	COM	7809	8027	9735
			1	7986	8204	10266
			2	8163	8381	10797
			3	8305	8523	11222
			4	8541	8759	11931
			5	8765	8983	12604
			COL	8423	8641	N/A
			LUBL	8541	8759	N/A
			LUCL	9096	9314	N/A
			LSL	9698	9916	N/A
Learn armchair  12,7 kg	6885	7144	COM	8552	8811	10416
			1	8729	8988	10947
			2	8906	9165	11478
			3	9048	9307	11903
			4	9284	9543	12612
			5	9508	9767	13285
			COL	9166	9425	N/A
			LUBL	9284	9543	N/A
			LUCL	9839	10098	N/A
			LSL	10441	10700	N/A

Price list 2023 - SEK excl. V.A.T. - Version 1.2

Soft lane castors	+123	SEK
Bag hook*	+245	SEK
Cupholder	+286	SEK

# AS100

By Andreas Störiko

The AS series is highly inspired and highly functional. Combining elegance and utility with true mobility, the family of nesting chairs and tables leaves room for all imaginable purposes.

- 10 year warranty
- Lightweight and space-saving
- Easy to link multiple chairs for relocation
- Weight activated brake castors
- Stacks horizontally as many chairs as wanted
- FSC certified
- Return swivel mechanism with 4 positions

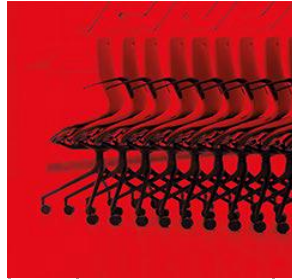

STANDARD ARMRESTS, SEATBAR AND BASE COLOURS



B6 B7 B51

GROUP FULLY UPHOLSTERED (DU)

Side chair (CBBS/CABS) 10,3 kg

COM	9285
1	9708
2	10130
3	10635
4	11398
5	11889
COL	11085
LUBL	11398
LUCL	13525
LSL	16102

Armchair (CBBA/CABA) 11,2 kg

COM	10062
1	10485
2	10907
3	11412
4	12175
5	12666
COL	11862
LUBL	12175
LUCL	14302
LSL	16879

Price list 2023 - SEK excl. V.A.T. - Version 1.1

Soft castors for hard floors  +123 SEK

# The Tongue

By Arne Jacobsen

The Tongue chair moved us from the very beginning. We fell truly, madly, deeply in love with this visionary yet playful design from 1955.

- Chair's aesthetics exactly as Jacobsen specified
- Extra strength provided through precise engineering
- 5 year guarantee
- All parts can be dismantled and recycled
- FSC certified



		UPHOLSTERED (GUA)	
		DivinaMD	Savanne*
Please note that veneer is a natural material - differences in structure and colour may occur. STANDARD FRAME COLOURS  B1 B7 B30  RAL K5 colours available at customer request 4-Leg (MC)		613	330
		813	302
		433	314
		453	*MOQ 4 pcs per 1 colour
		SEK	SEK
		10167	15607

Price list 2023 - SEK excl. V.A.T. - Version 1.1

# Munkegaard chair

By Arne Jacobsen

The Munkegaard chair is a controversial design that turns heads as much today as it did when it was created in 1955. It offers easy functionality while maintaining a strong visual identity.

- The epitome of modernist design by Jacobsen
- Stacks 20 chairs on a dolly
- Stacks 15 chairs in upholstery on a dolly
- 5 year guarantee
- All parts can be dismantled and recycled
- FSC certified



Please note that veneer is a natural material - differences in structure and colour may occur.  
STANDARD FRAME COLOURS



RAL K5 colours available at customer request  
4-Leg (MB)



Barstool Seating height 775 mm (AE)



Barstool Seating height 630 mm (AF)



SEAT UPH. (RRA)	FULLY UPH. (RUA)
GROUP	SEK
COM	7090
1	7295
2	7704
3	8235
4	8644
5	9381
COL	8522
LBBL	9381
LSL	13594
LPCL	10894
COM	9544
1	9749
2	10158
3	10689
4	11098
5	11835
COL	10976
LBBL	11835
LSL	16048
LPCL	13348
COM	9544
1	9749
2	10158
3	10689
4	11098
5	11835
COL	10976
LBBL	11835
LSL	16048
LPCL	13348

Price list 2023 - SEK excl. V.A.T. - Version 1.2

# Accessories

## 40/4 Writing tablet

Most people see the 40/4 as a pioneering design that has stood the test of time. We like to think of it as a legacy that continues to move you in new ways.

All accessories are recommended for chrome frames only.



<b>Writing tablet without or with cupholder</b>		
Writing tablet without cupholder 40/4 writing tablet, chrome frame, 10 mm compact laminate Left and right version is available		Per Piece
		SEK
No Cupholder	Black	2277
No Cupholder	White	2277
Cupholder	Black	2591
Cupholder	White	2591
<b>40/4 and SixE Transporter for writing tablets</b>		
Writing tablet dolly, up to 18 pcs. Dolly with 3 boxes, length: 410 mm, depth: 610 mm, height: 1400 mm.		Per Transporter
Writing tablet dolly, up to 36 pcs. Double dolly with 6 boxes, length: 810 mm, depth: 610 mm, height: 1400 mm.		
		SEK
18 Pcs	3 boxes	7554
36 pcs	6 boxes	14780



Price list 2023 - SEK excl. V.A.T. - Version 1.1







# Accessories

## 40/4 Linking

Most people see the 40/4 as a pioneering design that has stood the test of time. We like to think of it as a legacy that continues to move you in new ways.

All accessories are recommended for chrome frames only.



<p style="text-align: center;"><b>LD linking</b></p>	<p>Per Piece</p>	
<p>Width between seats: 65 mm. Linking side chair to side chair; allows to link chairs in a straight line.</p>		
<p>40/4 linking device LD1H in chrome</p>	<p>SEK 340</p>	
<p>Width between seats: 125 mm. Linking: side chair to side chair; side chair to armchair; allows to link chairs in a straight line.</p>		
<p>40/4 linking device LD2H in chrome</p>	<p>453</p>	
<p>Width between seats: 185 mm. Linking: side chair to side chair; side chair to armchair; armchair to armchair; allows to link chairs in a straight line.</p>		
<p>40/4 linking device LD3H in chrome</p>	<p>510</p>	
<p>Width between seats: 80 mm. Linking side chair to side chair; allows to form the arc of chairs; the radius is adjustable, 0-12 degrees.</p>		
<p>40/4 radius linking device LD2RL in chrome</p>	<p>566</p>	
<p>Width between seats: 202 mm. Linking armchairs with writing tablets to armchairs with writing tablets; allows to link chairs in a straight line.</p>		
<p>40/4 linking device LD4S in chrome</p>	<p>651</p>	
<p>Width between seats: 70 mm. Linking side chair to side chair; allows to link chairs in a straight line. Recommended for public spaces where EN 14703 is a requirement.</p>		
<p>40/4 safety linking device LD5S in chrome</p>	<p>682</p>	

Price list 2023 - SEK excl. V.A.T. - Version 1.1

# Accessories

## 40/4 Dolly and Glides

Most people see the 40/4 as a pioneering design that has stood the test of time. We like to think of it as a legacy that continues to move you in new ways.

All accessories are recommended for chrome frames only.



Dollies		Per Piece
All accessories recommended for chrome frames only. Dollies suit side chairs and arm chairs in polyamide, veneer, or full upholstery. For dollies to other versions of the 40/4 chair - please ask HOWE		SEK
Hook/eye, fin linking or without linking	DLYSSAASF10	6661
Brace linking or wood frame	DLYSSBCSF10	6661
Double dolly		15994
Triple dolly		21716
Quatro dolly		24883



Extra glides with felt		Per Piece
		SEK
For hook/eye and fin-linking chairs on chrome frames		
Transparent female glides with felt with screws		57
Transparent male glides with felt with screws		57
Transparent regular glides with felt		57
For non-linking chairs; for linking armchairs and for brace-linking side chairs		
Transparent regular glides with felt for both chrome and painted frames		57
Transparent bar glides with felt for both chrome and painted frames		57



Extra glides without felt		Per Piece
		SEK
For hook/eye and fin-linking chairs on chrome frames		
Transparent female glides without felt with screws		42
Transparent male glides without felt with screws		42
Transparent regular glides without felt		42
For non-linking chairs; for linking armchairs and for brace-linking side chairs		
Transparent regular glides without felt for chrome frames		42
Transparent regular glides without felt for painted frames		42
Transparent bar glides with felt for both chrome and painted frames		42





# Accessories

## 40/4 Linking items and book holders

Most people see the 40/4 as a pioneering design that has stood the test of time. We like to think of it as a legacy that continues to move you in new ways.

All accessories are recommended for chrome frames only.



LD linking continued		Per Piece	
Width between seats: 70 mm. Linking side chair to side chair; allows to link chairs in a straight line. Recommended for public spaces where EN 14703 is a requirement.	SEK		
40/4 safety linking device LD55	772		
Cup holder for 40/4 safety linking device LD55	87		
Numbering for 40/4 safety linking device LD55	87		
Linking tool			
40/4 Linking tool In chrome. An aid to the linking/unlinking operation of side chairs with integrated linking.			
Linking tool (for side chairs with integrated linking)	382		
Row spacer bar In HOWE grey powdercoating with rubber lock, allows a 350 mm aisle between rows.			
Row spacer bar for armchairs, 350 mm distance between the rows	665		
Row spacer bar for side chairs, 350 mm distance between the rows	665		
Bookholders			
40/4 book rack in chrome			
Book rack (for side chairs and armchairs)	1062		
Hymn book holder In chrome, 120 mm high and 175 mm long; 154 mm wide (distance between front legs of chairs) with integrated linking. Note! Hymn book holder does not work with the writing tablet.			
Hymn book holder (for side chairs and armchairs, non-linking)	538		

Price list 2023 - SEK excl. V.A.T. - Version 1.1

# Accessories

## 40/4 Numbering tag

Most people see the 40/4 as a pioneering design that has stood the test of time. We like to think of it as a legacy that continues to move you in new ways.

All accessories are recommended for chrome frames only.



<b>Numbering tags for row and seat</b>		
The price of one numbering tag. The start-up fee is 300 SEK.	Per Piece	
40/4 Row/seat numbering tag	SEK 522	



Price list 2023 - SEK excl. V.A.T. - Version 1.1

# Accessories

## SixE Writing tablet and Dolly

No matter how you look at SixE, it presents itself as a perfectly bold move – bending the rules of how comfortable a simple polypropylene shell chair can be.



<b>Writing tablet without or with cupholder</b>		Per Piece  SEK		
Writing tablet without cupholder SixE writing tablet, chrome frame, 10 mm compact laminate Left and right version is available				
No Cupholder	Black			2291
No Cupholder	White			2291
Cupholder	Black			2605
Cupholder	White			2605
<b>40/4 and SixE Transporter for writing tablets</b>		Per Transporter  SEK		
Writing tablet dolly, up to 18 pcs. Dolly with 3 boxes, length: 410 mm, depth: 610 mm, height: 1400 mm.				
Writing tablet dolly, up to 36 pcs. Double dolly with 6 boxes, length: 810 mm, depth: 610 mm, height: 1400 mm.				
18 Pcs	3 boxes 404WTDLY01			7554
36 pcs	6 boxes 404WTDLY02	14780		
<b>Dolly for SixE 4-leg and sled</b>		Per Dolly  SEK		
Single HOWE grey dolly with multidirectional castors Accommodates up to 25 chairs.				
25 chairs 22920010				9901



Price list 2023 - SEK excl. V.A.T. - Version 1.1

# Accessories

## Munkegaard

The Munkegaard chair is a controversial design that turns heads as much today as it did when it was created in 1955. It offers easy functionality while maintaining a strong visual identity.



<p><b>Linking for side chair</b></p>	<p>Per Piece</p> <p>SEK</p>	
<p>Linking for side chairs (quick linking)</p>		
<p>No Cupholder      22011</p>	<p>410</p>	
<p><b>Loose stacking pan (For upholstered chairs)</b></p>	<p>Per Transporter</p> <p>SEK</p>	
<p>The stacking pan prevents stacking marks in the upholstery.</p>		
<p>36 pcs      22007</p>	<p>198</p>	
<p><b>Dolly</b></p>	<p>Per Dolly</p> <p>SEK</p>	
<p>Single HOWE grey dolly with multidirectional castors Accommodates up to 20 chairs.</p>		
<p>25 chairs      22920010</p>	<p>9901</p>	

Price list 2023 - SEK excl. V.A.T. - Version 1.1

# Notes for chairs

Price list 2023 - SEK excl. V.A.T. - Version 1.1

## General

---

HOWE standard delivery times in EU are usually: Chairs 4-6 weeks, Tables 5-7 weeks.

In case of large quantities and/or customized products delivery time will be determined on a case-by-case basis.

The following products may have a slightly longer lead time so please ask HOWE:

- 40/4: Slim Armchairs, Dining height, Barstools, Veneer (other than Walnut/Oak/Black Stained), Xtra, Lounge, Wood
- SixE: 4-leg on castors, Brace-linking, Barstools
- Munkegaard: White Frame
- Tongue: White Frame
- AS100 upholstered

For chairs with upholstery, the lead time starts being counted once fabric reaches the production line.

We recommend linking only for chrome frames.

Frame colours from RAL K5 colour card are available. For quantities < 200 chairs the colour fee is 2400 SEK per RAL colour. For quantities ≥ 200 chairs there is no fee. Visual impressions of particular RAL may differ on various surfaces. Preparing product's sample(s) is compulsory. Lead time to be confirmed by HOWE CS.

Stained veneer is possible with RAL colours from RAL K5 colour card. For quantities < 200 chairs the colour fee is 1100 SEK per RAL colour. For quantities ≥ 200 chairs there is no fee. Visual impression of particular RAL may differ on various surfaces. Preparing product's sample(s) is compulsory. Lead time to be confirmed by HOWE CS.

We recommend only stacking chairs with chrome frame.

Veneer is a natural material - differences in structure and colour may occur.

Upholstered armrests are as standard in the same fabric/leather type and colour as the seat and the back.

Savanne leather: Minimum 4 chairs per colour per order required.

Soft castors are recommended for hard floors, hard castors are recommended for soft floors.

## 40/4

---

Table surface protection protects the table surface when the chairs are hung up; it may be used only for non-linking chairs.

Please be aware that extra glides are not available for wooden frames.

40/4 can be stacked on a single, double, triple or quarto dolly. Double, triple, and quarto can only be used with hook/eye linking.

As standard chair top frame and its swivel base are of the same colour but be aware that they are always matched by the chrome gas lift.

Glides for linking side chairs; the whole set for one linking side chair comprises of one male glide and one female glide at the front part of the frame (reinforcing the linking in the front part of the chair frame) plus two regular glides at the rear part of the frame; whether these are glides with or without felt depends only on customer's needs.

Regular glides are suitable for non-linking side chairs, for all types of armchairs and for lounge chairs; the whole set comprises of four clear regular glides per chair.

Glides for barstool with both chrome and painted frames; the whole set comprises of four regular glides per chair.

## MN1

---

Fixed seating height - there is no possibility to install both height adjustable and return mechanism together.

Gas lift is black for black base and chrome for polished aluminium base.

**Munkegaard**

---

If upholstered chairs are to be stacked, please order the lose stacking pan to prevent stacking marks in the upholstery.

**SixE**

---

Bag hook is recommended only for polypropylene backs.

# Fabric suitability

Standard collection of the carefully selected fabrics suitable for the HOWE products. They were all thoroughly tested, therefore we can guarantee these textiles meet our highest standards. Please check here which fabrics are dedicated to each of our product. If you're looking for a solution that reaches beyond standard options, please contact HOWE Customer Service.



Supplier	Fabric's name	Supplier's fabric card EMEA	40/4	Munkegaard	SixE	Tongue	AS100	Price gr.Sweden
Gabriel	Cura	link	✓	✓	✓	✓	✓	1
Gabriel	Event	link	✓	✓	✓	✓	✓	1
Gabriel	Fighter	link	✓	X		X		1
Camira	Main Line Plus	link	✓	X	✓	✓	✓	1
Camira	Oceanic	link	✓	✓	✓	✓	X	1
Camira	Rivet	link	✓	✓	✓	✓	X	1
Gabriel	Step	link	✓	X	✓	X	X	1
Gabriel	Step Melange	link	✓	✓	✓	X	✓	1
Camira	Main Line Flax	link	✓	✓	✓	✓	✓	2
Gabriel	Crisp	link	✓		✓	X	✓	3
Gabriel	Fame	link	✓	X	✓	X	✓	3
Kvadrat	Steelcut Trio 3	link	✓	X	✓	X	✓	5

✓ - fabric suitable for the product  
 X - fabric not suitable for the product  
 blank window - fabric requires testing

# Fabric suitability

Standard collection of the carefully selected fabrics suitable for the HOWE products. They were all thoroughly tested, therefore we can guarantee these textiles meet our highest standards. Please check here which fabrics are dedicated to each of our product. If you're looking for a solution that reaches beyond standard options, please contact HOWE Customer Service.



Supplier	Fabric's name	Composition	Marrindale	Flammability CAL 117	Added flame retardant	Flammability M	Washable	Cleanable	Ecolabel	Oeko-Tex
Gabriel	Cura	98% post-consumer recycled polyester, 2% polyester	100000	YES	NO	NO	60-74°C	YES	✓	✓
Gabriel	Event	100% polyester	100000	YES	NO	NO	60°C	YES	✓	✓
Gabriel	Fighter	100% recyclable polyester	130 000	YES	NO	NO	YES	only dry	NO	✓
Camira	Main Line Plus	67% Wool, 20% Flame Retardant Viscose, 13% Viscose	≥50,000	NO	YES	NO	YES	YES	NO	✓
Camira	Oceanic	100% post-consumer recycled polyester	≥100,000	YES	NO	NO	60°C	YES	✓	✓
Camira	Rivet	100% post-consumer recycled polyester	≥80,000	YES	NO	NO	60°C	YES	✓	NO
Gabriel	Step	100% Trevira cs	100 000	YES	YES	M1	60-74°C	YES	✓	✓
Gabriel	Step Melange	100% Trevira cs	100 000	YES	YES	M1	60-74°C	YES	✓	✓
Camira	Main Line Flax	70% Virgin Wool, 30% Flax	≥50,000	YES	NO	NO	NO	YES	✓	NO
Gabriel	Crisp	93% wool, 7% polyamide	200 000	YES	NO	M1	NO	YES	✓	✓
Gabriel	Fame	95% wool, 5% polyamide	200 000	YES	NO	NO	NO	only dry	✓	✓
Kvadrat	Steelcut Trio 3	90% New wool, 10% Nylon	100 000	YES	NO	NO	NO	only dry	✓	NO



# Moveo Training

By Justus Kolberg & Erik Simonsen

Easy to move thanks to a light frame, Moveo is even more flexible than your calendar. Optimum mobility is ensured by the perfectly designed wheels.

- 10 year warranty
- GreenTag<sup>Cert™</sup>
- FSC certified
- PEFC certified
- C-leg style
- Flip top table system
- 33% recycled materials

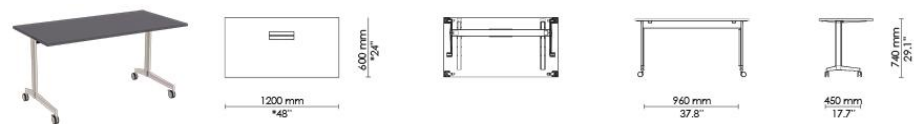
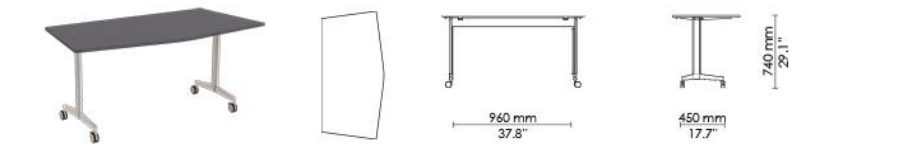

	Laminate (MB2)	Linoleum (MB4)	Veneer (MB3)	Stained veneer (MB3)	
Melamine, Laminate and Linoleum are with matching ABS edge. Veneer is with matching hardwood edge. Table top thickness: Melamine is 25mm. Laminate, Linoleum and veneer is 24mm.	L42 L43 L50 L55 L310 L420 L110 L600 L500 L210	FL200	V1 V2 V3 V5 V12 V13 V15	LW17 LW25 LW30	
 B6 B51 B52					Linking
Standard frame* with castors with breaks	SEK	SEK	SEK	SEK	
					
Rectangular	1200x600mm (32AA)	14763	16907	18383	21256
Rectangular	1400x700mm (43AD)	15395	17631	19170	22043
Rectangular	1500x600mm (34AL)	15569	17830	19387	22260
Rectangular	1500x750mm (44AE)	15932	18247	19839	22712
Rectangular	1800x600mm (36AM)	16011	18337	19938	22811
					
V-shape	1200x600mm (22BO)	15395	17631	19170	22043
V-shape	1400x700mm (73BP)	15853	18156	19741	22614
V-shape	1500x750mm (74BQ)	16011	18337	19938	22811

Price list 2023 - SEK excl. V.A.T. - Version 1.2

# Moveo Meeting

By Justus Kolberg & Erik Simonsen

Easy to move thanks to a light frame, Moveo is even more flexible than your calendar. Optimum mobility is ensured by the perfectly designed wheels.

- 10 year warranty
- GreenTag<sup>Cert™</sup>
- FSC certified
- PEFC certified
- Inverted T-leg style
- Flip top table system
- 33% recycled materials



	Laminate (MT2)	Linoleum (MT4)	Veneer (MT3)	Stained veneer (MT3)	
Melamine, Laminate and Linoleum are with matching ABS edge. Veneer is with matching hardwood edge. Table top thickness: Melamine is 25mm. Laminate, Linoleum and veneer is 24mm.	L42 L43 L50 L55 L310 L420 L110 L600 L500 L210	FL200	V1 V2 V3 V5 V12 V13 V15	LW17 LW25 LW30	
Standard frame* with castors with breaks	SEK	SEK	SEK	SEK	SEK
Rectangular	1400x700mm (23AD)	15415	17656	19193	22066
Rectangular	1500x750mm (24AE)	15947	18265	19858	22731
Rectangular	1600x800mm (35AF)	16507	18906	20558	23431
Rectangular	1600x795mm (35SG)	N/A	N/A	N/A	N/A
Rectangular	1800x795mm (36TA)	N/A	N/A	N/A	N/A
Rectangular	1800x900mm (46AJ)	17168	19667	21377	24250
Half-round	1500x750mm (12BC)	16507	18906	20558	23431
Half-round	1600x800mm (35BR)	16866	N/A	N/A	N/A
V-Shape	1500x750mm (34BQ)	16009	18346	19940	22813
V-Shape	1600x800mm (35BR)	16679	19100	20764	23637

Price list 2023 - SEK excl. V.A.T. - Version 1.2

# Moveo Conference modular

By Justus Kolberg & Erik Simonsen

Easy to move thanks to a light frame, Moveo is even more flexible than your calendar. Optimum mobility is ensured by the perfectly designed wheels.

- 10 year warranty
- GreenTag<sup>Cert™</sup>
- FSC certified
- PEFC certified
- Inverted T-leg style
- Flip top table system
- 33% recycled materials



	Laminate (MV2)	Linoleum (MV4)	Veneer (MV3)	Stained veneer (MV3)		
Melamine, Laminate and Linoleum are with matching ABS edge. Veneer is with matching hardwood edge. Table top thickness: Melamine is 25mm. Laminate, Linoleum and veneer is 24mm.	L42 L43 L50 L55 L310 L420 L110 L600 L500 L210	FL200	V1 V2 V3 V5 V12 V13 V15	LW17 LW25 LW30	Linking	
 B6 B51 B52	SEK	SEK	SEK	SEK		SEK
Standard frame* with castors with breaks						
Rectangular	1800x1000mm (46AN)	32669	37410	40685	46432	+1724
Rectangular	1800x1200mm (46AO)	34881	39938	43443	49190	
Rectangular	2200x1000mm (48ER)	35255	40384	43917	49664	
Rectangular	2200x1200mm (48AR)	38147	43688	47521	53268	
Half-Boat	2000x1000mm (86BK)	34982	40053	43558	49305	+862
Half-Boat	2000x1200mm (86BL)	38329	43889	47734	53481	
Half-Boat	2400x1000mm (89BM)	37764	43243	47021	52768	
Half-Boat	2400x1200mm (89BN)	41892	47984	52178	57925	

Price list 2023 - SEK excl. V.A.T. - Version 1.2

# Moveo Conference stand alone

By Justus Kolberg & Erik Simonsen

Easy to move thanks to a light frame, Moveo is even more flexible than your calendar. Optimum mobility is ensured by the perfectly designed wheels.

- 10 year warranty
- GreenTag<sup>Cert™</sup>
- FSC certified
- PEFC certified
- Inverted T-leg style
- Flip top table system
- 33% recycled materials

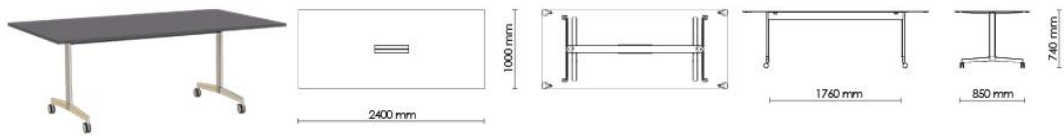
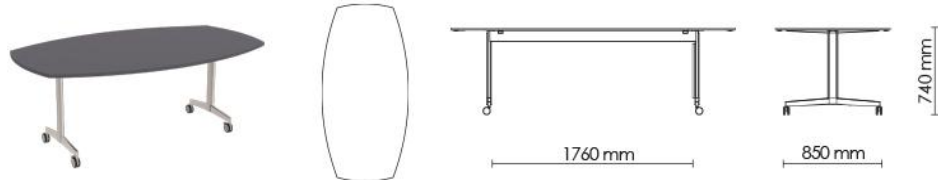

	Laminate (MR2)	Linoleum (MR4)	Veneer (MR3)	Stained veneer (MR3)		
Melamine, Laminate and Linoleum are with matching ABS edge. Veneer is with matching hardwood edge. Table top thickness: Melamine is 25mm. Laminate, Linoleum and veneer is 24mm.	L42 L43 L50 L55 L310 L420 L110 L600 L500 L210	FL200	V1 V2 V3 V5 V12 V13 V15	LW17 LW25 LW30	Linking	
 Standard frame* with castors with breaks	SEK	SEK	SEK	SEK		SEK
						
Rectangular	2000x1000mm (45AJ)	33603	38487	41839	47586	+1724
Rectangular	2000x1200mm (45AP)	35853	41059	44627	50374	
Rectangular	2400x1000mm (47AS)	36735	42068	45732	51479	
Rectangular	2400x1200mm (47AK)	39105	44779	48692	54439	
						
Boat-shape	2000x1000mm (95BG)	35485	40642	44181	49928	+1724
Boat-shape	2000x1200mm (45BH)	37914	43429	47212	52959	
Boat-shape	2400x1000mm (97BI)	37525	42969	46724	52471	
Boat-shape	2400x1200mm (47BJ)	40949	46906	50990	56737	

Price list 2023 - SEK excl. V.A.T. - Version 1.2

# Moveo modesty panel

By Justus Kolberg & Erik Simonsen

Easy to move thanks to a light frame, Moveo is even more flexible than your calendar. Optimum mobility is ensured by the perfectly designed wheels.

- 10 year warranty
- FSC certified



	Laminate	Linoleum	Veneer
<b>MODESTY PANEL</b>	L42 ●	FL200 ●	V1 ●
	L43 ●		V2 ●
	L50 ●		V3 ●
	L55 ●		V5 ●
	L310 ●		V12 ●
	L420 ●		V13 ●
	L110 ●		V15 ●
	L600 ●		
	L500 ●		
	L210 ●		
	SEK	SEK	SEK
Beam length 975 mm (GCGC)	3185	4388	4501
Beam length 1175 mm (GDGD)	3468	4784	4897
Beam length 1275 mm (GEGE)	3751	5166	5308
Beam length 1375 mm (GFGF)	3751	5166	5308
Beam length 1575 mm (GGGG)	3751	5166	5308
Beam length 1775 mm (GHGH)	4034	5563	5704

Price list 2023 - SEK excl. V.A.T. - Version 1.2



# Simpla

By John Bollen

The unique folding system makes Simpla radically different. In addition to a minimalist and elegant silhouette, the two-piece table is flexible and space-saving.

- Lift off top
- Unique flat folding frame
- PEFC certified
- FSC certified
- Up to 8 stacked tables on a transporter
- 5 year warranty

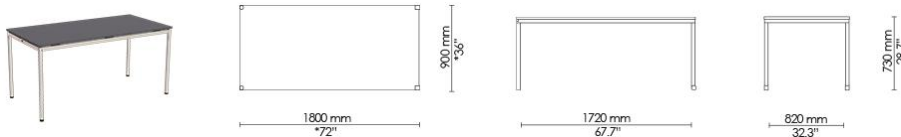

		Laminate (SG2)	Linoleum (SG4)	Veneer (SG3)	Stained Veneer (SG3)	
Melamine, Laminate and Linoleum are standard with matching ABS edge. Veneer is standard with matching hardwood edge. Table top thickness is 18mm Standard frame with glides - optional to get glides and castors. Linking is incl. 2 brackets		L42 ● L43 ● L50 ● L55 ● L310 ● L420 ● L110 ● L600 ● L500 ● L210 ●	FL200 ●	V1 ● V2 ● V3 ● V5 ● V12 ● V13 ● V15 ●	LW17 ● LW25 ● LW30 ●	Linking
		SEK	SEK	SEK	SEK	
Rectangular	1200x600mm (AAAA)	13167	15100	16428	19301	+ 345
Rectangular	1400x700mm (ADAD)	13825	15854	17248	20121	
Rectangular	1500x750mm (AEAE)	14216	16303	17737	20610	
Rectangular	1600x795mm (SGSG)	N/A	N/A	N/A	N/A	
Rectangular	1600x800mm (AFAF)	14764	16931	18420	21293	
Rectangular	1800x900mm (AIAI)	15720	18027	19612	22485	
						
Square	750x750mm (BZBZ)	12713	14579	15861	18734	+ 345
						
Half-round	1400x700mm (BBBB)	14905	17093	18596	21469	+ 345
Half-round	1500x750mm (BCBC)	15234	17470	19007	21880	
Half-round	1600x800mm (BDDB)	15547	17829	19397	22270	

Price list 2023 - SEK excl. V.A.T. - Version 1.1

2 glides and 2 castors +115 SEK

# Simpla

By John Bollen

The unique folding system makes Simpla radically different. In addition to a minimalist and elegant silhouette, the two-piece table is flexible and space-saving.

- Lift off top
- Unique flat folding frame
- PEFC certified
- FSC certified
- 5 year warranty

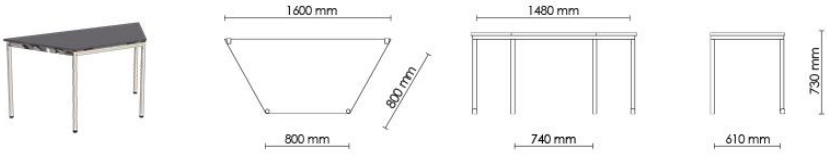
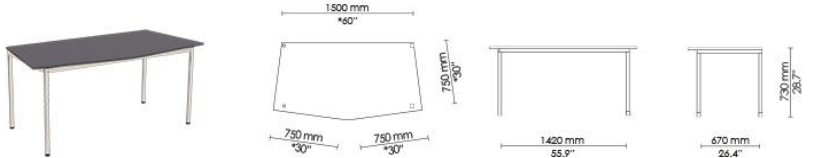

		Laminate (SG2)	Linoleum (SG4)	Veneer (SG3)	Stained Veneer (SG3)
Melamine, Laminate and Linoleum are standard with matching ABS edge. Veneer is standard with matching hardwood edge. Table top thickness is 18mm Standard frame with glides - optional to get glides and castors. Linking is incl. 2 brackets 		L42 ● L43 ● L50 ● L55 ● L310 ● L420 ● L110 ● L600 ● L500 ● L210 ●	FL200 ●	V1 ● V2 ● V3 ● V5 ● V12 ● V13 ● V15 ●	LW17 ● LW25 ● LW30 ●
		SEK	SEK	SEK	SEK
Trapezoid	1500x750mm (BEBE)	14436	16554	18010	20883
Trapezoid	1600x800mm (BFBF)	14764	16931	18420	21293
					
V-Shaped	1500x750mm (BQBQ)	15594	17883	19456	22329
					
Round	Ø1050mm (BUBU)	15125	17345	18870	21743
Round	Ø1200mm (BVBV)	16252	18637	20277	23150

Price list 2023 - SEK excl. V.A.T. - Version 1.1

2 glides and 2 castors +115 SEK

# Simpla modesty panel

By John Bollen

The unique folding system makes Simpla radically different. In addition to a minimalist and elegant silhouette, the two-piece table is flexible and space-saving.



Modesty panel		
Simpla modesty panel in perforated steel, 250 mm high, with integrated cable tray and hooks to hang it on the Simpla frame.		Steel
Simpla modesty panel in acrylic, 4 mm thick and 250 mm high, made of greenish acrylic plastic, mounted on the hooks.		SEK
Rectangular	1200 mm (DEDEGHY)	3369
Rectangular	1400 mm (DGDGGHY)	3369
Rectangular	1500 mm (DHDHGHY)	3935
Rectangular	1600 mm (DIDIGHY)	3935
Rectangular	1800 mm (DKDKGHY)	3935

Price list 2023 - SEK excl. V.A.T. - Version 1.2





# Tempest flip top

By KOMPLOT Design

Detail is everything. It is why the Tempest flips, rolls and unfolds possibilities like no other table system in the world.

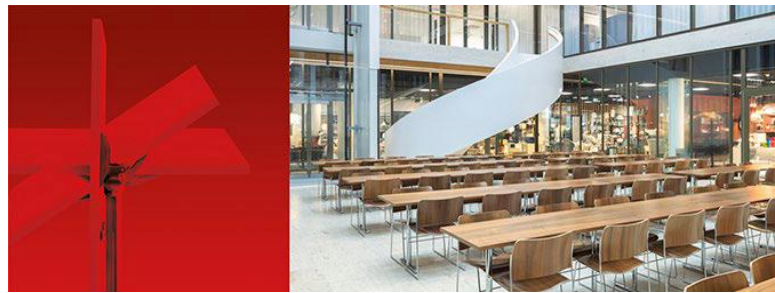
- 10 year warranty
- World's leading flip-top table system
- Nesting depth of 130 mm
- 6 tables can be stacked on table transporter
- Elegant elliptical leg-design
- GreenTag<sup>Cert™</sup>
- FSC certified
- ISO 14025 EPD
- **Quick ship - LINK**

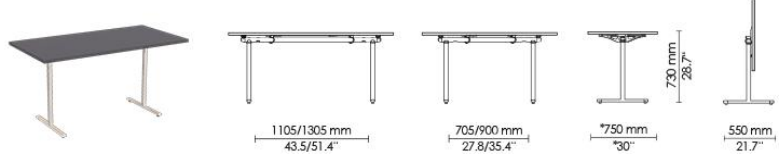
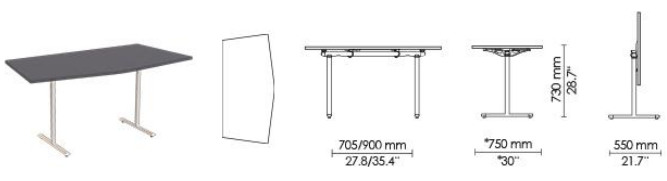

	Laminate (TP2)	Linoleum (TP4)	Veneer (TP3)	Stained veneer (TP3)		
Melamine, laminate and linoleum are with matching ABS edge. Veneer is with matching hardwood edge. Other RAL colours available - ASK HOWE  Table top thickness: Melamine is 25mm. Laminate, linoleum and veneer is 27mm. Standard frame with glides and castors	L42 L43 L50 L55 L310 L420 L110 L600 L500 L210 SEK	FL200 SEK	V1 V2 V3 V5 V12 V13 V15 SEK	LW17 LW25 LW30 SEK	Linking SEK	
						
Rectangular	1200x600mm (02AA)	15162	17183	18954	21762	+1724
Rectangular	1200x750mm (02AB)	15697	17789	19622	22430	
Rectangular	1200x800mm (02AC)	15778	17881	19723	22531	
Rectangular	1400x700mm (02AD)	15875	17991	19845	22653	
Rectangular	1500x750mm (02AE)	16409	18597	20513	23321	
Rectangular	1600x795mm (02SG)	N/A	N/A	N/A	N/A	
Rectangular	1600x800mm (02AF)	16766	19000	20959	23767	
Rectangular	1800x750mm (03AG)	17122	19404	21404	24212	
Rectangular	1800x795mm (03TA)	N/A	N/A	N/A	N/A	
Rectangular	1800x800mm (03AH)	17478	19808	21850	24658	
Rectangular	1800x900mm (03AI)	17932	20322	22417	25225	
Rectangular	2000x795mm (03OZ)	N/A	N/A	N/A	N/A	
Rectangular	2000x1000mm (03AJ)	19439	22030	24300	27108	
						
V-Shape	1500x750mm (02BQ)	18726	21222	23409	26217	N/A

Price list 2023 - SEK excl. V.A.T. - Version 1.2



# Tempest flip top

By KOMPLOT Design

Detail is everything. It is why the Tempest flips, rolls and unfolds possibilities like no other table system in the world.

- 10 year warranty
- World's leading flip-top table system
- Nesting depth of 130 mm
- 6 tables can be stacked on table transporter
- Elegant elliptical leg-design
- GreenTag<sup>CertTM</sup>
- FSC certified
- ISO 14025 EPD

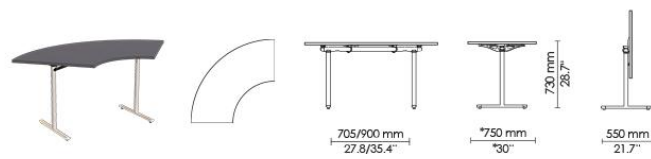

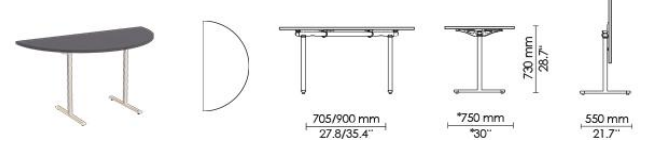
	Laminate (TP2)	Linoleum (TP4)	Veneer (TP3)	Stained veneer (TP3)	
Melamine, laminate and linoleum are with matching ABS edge. Veneer is with matching hardwood edge. Other RAL colours available - ASK HOWE  Table top thickness: Melamine is 25mm. Laminate, linoleum and veneer is 27mm. Standard frame with glides and castors	L42 L43 L50 L55 L310 L420 L110 L600 L500 L210 SEK	FL200 SEK	V1 V2 V3 V5 V12 V13 V15 SEK	LW17 LW25 LW30 SEK	Linking SEK
					
Crescent	1200x750mm (02AW)	21139	23957	26426	29234
Crescent	1400x700mm (02AY)	22225	25187	27783	30591
Crescent	1500x750mm (02AZ)	23083	26160	28856	31664
Crescent	1600x800mm (03BA)	24606	27886	30759	33567
					
Trapezoid	1500x750mm (01BE)	16944	19202	21181	23989
Trapezoid	1600x800mm (01BF)	17381	19698	21728	24536
					
Half-round	1400x700mm (01BB)	16409	18597	20513	23321
Half-round	1500x750mm (01BC)	16766	19000	20959	23767
Half-round	1600x800mm (02BD)	17252	19551	21566	24374

Price list 2023 - SEK excl. V.A.T. - Version 1.2

# Tempest fold

By KOMPLOT Design

Detail is everything. It is why the Tempest flips, rolls and unfolds possibilities like no other table system in the world.

- 10 year warranty
- Inverted elliptical T-leg style
- Legs: concealed wheel + adjustable glides
- 5 tables can be stacked on table transporter
- FSC certified



	Laminate (TD2/TA2)	Linoleum (TD4/TA4)	Veneer (TD3/TA3)	Stained veneer (TD3/TA3)																																																																			
<p>Melamine, laminate and linoleum are with matching ABS edge. Veneer is with matching hardwood edge. Other RAL colours available - ASK HOWE</p> <p>Table top thickness: Melamine is 25mm. Laminate, linoleum and veneer is 27mm.</p>	L42 L43 L50 L55 L310 L420 L110 L600 L500 L210 SEK	FL200 SEK	V1 V2 V3 V5 V12 V13 V15 SEK	LW17 LW25 LW30 SEK	Linking																																																																		
						SEK																																																																	
<table border="1"> <thead> <tr> <th>Rectangular</th> <th>1200x600mm (04AA)</th> <th>18282</th> <th>20719</th> <th>22853</th> <th>25987</th> </tr> </thead> <tbody> <tr> <td>Rectangular</td> <td>1200x750mm (04AB)</td> <td>18915</td> <td>21436</td> <td>23644</td> <td>26778</td> </tr> <tr> <td>Rectangular</td> <td>1200x800mm (04AC)</td> <td>19041</td> <td>21580</td> <td>23802</td> <td>26936</td> </tr> <tr> <td>Rectangular</td> <td>1400x700mm (04AD)</td> <td>19150</td> <td>21703</td> <td>23938</td> <td>27072</td> </tr> <tr> <td>Rectangular</td> <td>1500x750mm (05AE)</td> <td>19783</td> <td>22420</td> <td>24729</td> <td>27863</td> </tr> <tr> <td>Rectangular</td> <td>1600x795mm (05SG)</td> <td>N/A</td> <td>N/A</td> <td>N/A</td> <td>N/A</td> </tr> <tr> <td>Rectangular</td> <td>1600x800mm (05AF)</td> <td>20217</td> <td>22912</td> <td>25272</td> <td>28406</td> </tr> <tr> <td>Rectangular</td> <td>1800x750mm (05AG)</td> <td>20651</td> <td>23404</td> <td>25814</td> <td>N/A</td> </tr> <tr> <td>Rectangular</td> <td>1800x795mm (05TA)</td> <td>N/A</td> <td>N/A</td> <td>N/A</td> <td>N/A</td> </tr> <tr> <td>Rectangular</td> <td>1800x800mm (05AH)</td> <td>21085</td> <td>23895</td> <td>26357</td> <td>N/A</td> </tr> <tr> <td>Rectangular</td> <td>1800x900mm (05AI)</td> <td>21609</td> <td>24490</td> <td>27012</td> <td>30146</td> </tr> </tbody> </table>	Rectangular	1200x600mm (04AA)	18282	20719	22853	25987	Rectangular	1200x750mm (04AB)	18915	21436	23644	26778	Rectangular	1200x800mm (04AC)	19041	21580	23802	26936	Rectangular	1400x700mm (04AD)	19150	21703	23938	27072	Rectangular	1500x750mm (05AE)	19783	22420	24729	27863	Rectangular	1600x795mm (05SG)	N/A	N/A	N/A	N/A	Rectangular	1600x800mm (05AF)	20217	22912	25272	28406	Rectangular	1800x750mm (05AG)	20651	23404	25814	N/A	Rectangular	1800x795mm (05TA)	N/A	N/A	N/A	N/A	Rectangular	1800x800mm (05AH)	21085	23895	26357	N/A	Rectangular	1800x900mm (05AI)	21609	24490	27012	30146					+1724
Rectangular	1200x600mm (04AA)	18282	20719	22853	25987																																																																		
Rectangular	1200x750mm (04AB)	18915	21436	23644	26778																																																																		
Rectangular	1200x800mm (04AC)	19041	21580	23802	26936																																																																		
Rectangular	1400x700mm (04AD)	19150	21703	23938	27072																																																																		
Rectangular	1500x750mm (05AE)	19783	22420	24729	27863																																																																		
Rectangular	1600x795mm (05SG)	N/A	N/A	N/A	N/A																																																																		
Rectangular	1600x800mm (05AF)	20217	22912	25272	28406																																																																		
Rectangular	1800x750mm (05AG)	20651	23404	25814	N/A																																																																		
Rectangular	1800x795mm (05TA)	N/A	N/A	N/A	N/A																																																																		
Rectangular	1800x800mm (05AH)	21085	23895	26357	N/A																																																																		
Rectangular	1800x900mm (05AI)	21609	24490	27012	30146																																																																		
<table border="1"> <thead> <tr> <th>Rectangular conf.</th> <th>2000x1000mm (05AJ)</th> <th>26262</th> <th>29753</th> <th>32827</th> <th>38574</th> </tr> </thead> <tbody> <tr> <td>Rectangular conf.</td> <td>2400x1200mm (05AK)</td> <td>29030</td> <td>32890</td> <td>36287</td> <td>42034</td> </tr> </tbody> </table>	Rectangular conf.	2000x1000mm (05AJ)	26262	29753	32827	38574	Rectangular conf.	2400x1200mm (05AK)	29030	32890	36287	42034					+1724																																																						
Rectangular conf.	2000x1000mm (05AJ)	26262	29753	32827	38574																																																																		
Rectangular conf.	2400x1200mm (05AK)	29030	32890	36287	42034																																																																		

Price list 2023 - SEK excl. V.A.T. - Version 1.2

# Tempest fold

By KOMPLOT Design

Detail is everything. It is why the Tempest flips, rolls and unfolds possibilities like no other table system in the world.

- 10 year warranty
- Inverted elliptical T-leg style
- Legs: concealed wheel + adjustable glides
- 5 tables can be stacked on table transporter
- FSC certified



	Laminate (TD2)	Linoleum (TD4)	Veneer (TD3)	Stained veneer (TD3)		
<p>Melamine, laminate and linoleum are with matching ABS edge. Veneer is with matching hardwood edge. Other RAL colours available - ASK HOWE</p> <p>Table top thickness: Melamine is 25mm. Laminate, linoleum and veneer is 27mm.</p>	L42 L43 L50 L55 L310 L420 L110 L600 L500 L210 SEK	FL200 SEK	V1 V2 V3 V5 V12 V13 V15 SEK	LW17 LW25 LW30 SEK	Linking	
Crescent	1200x750mm (04AW)	25479	28875	31849	34983	+1724
Crescent	1400x700mm (04AY)	26781	30351	33477	36611	
Crescent	1500x750mm (05AZ)	27830	31539	34788	37922	
Crescent	1600x800mm (05BA)	29674	33630	37094	40228	
Trapezoid	1500x750mm (05BE)	20434	23158	25543	28677	N/A
Trapezoid	1600x800mm (05BF)	21067	23875	26334	29468	

Price list 2023 - SEK excl. V.A.T. - Version 1.2

# Tempest fold

By KOMPLOT Design

Detail is everything. It is why the Tempest flips, rolls and unfolds possibilities like no other table system in the world.

- 10 year warranty
- Inverted elliptical T-leg style
- Legs: concealed wheel + adjustable glides
- 5 tables can be stacked on table transporter
- FSC certified



	Laminate (TD2)	Linoleum (TD4)	Veneer (TD3)	Stained veneer (TD3)			
<p>Melamine, laminate and linoleum are with matching ABS edge. Veneer is with matching hardwood edge. Other RAL colours available - ASK HOWE</p> <p>Table top thickness: Melamine is 25mm. Laminate, linoleum and veneer is 27mm.</p>	L42 L43 L50 L55 L310 L420 L110 L600 L500 L210 SEK	FL200 SEK	V1 V2 V3 V5 V12 V13 V15 SEK	LW17 LW25 LW30 SEK	Linking SEK		
	V-Shape	1500x750mm (05BQ)	22586	25596	28233	31367	N/A
	Half-round	1400x700mm (04BB)	19783	22420	24729	27863	+862
Half-round	1500x750mm (05BC)	20217	22912	25272	28406		
Half-round	1600x800mm (05BD)	20795	23568	25995	29129		

Price list 2023 - SEK excl. V.A.T. - Version 1.2

# Tempest fix

By KOMPLOT Design

Detail is everything. It is why the Tempest flips, rolls and unfolds possibilities like no other table system in the world.

- 10 year warranty
- Inverted elliptical T-leg style
- Legs: concealed wheel + adjustable glides
- GreenTag<sup>CertTM</sup>
- FSC certified
- ISO 14025 EPD



	Laminate (T12)	Linoleum (T14)	Veneer (T13)	Stained veneer (T13)		
<p>Melamine, laminate and linoleum are with matching ABS edge. Veneer is with matching hardwood edge. Other RAL colours available - ASK HOWE</p> <p>Table top thickness: Melamine is 25mm. Laminate, linoleum and veneer is 27mm.</p>	L42 L43 L50 L55 L310 L420 L110 L600 L500 L210 SEK	FL200 SEK	V1 V2 V3 V5 V12 V13 V15 SEK	LW17 LW25 LW30 SEK	Linking SEK	
Rectangular	1200x600mm (06AA)	13542	15348	16929	19737	+1724
Rectangular	1200x750mm (06AB)	14028	15899	17536	20344	
Rectangular	1200x800mm (06AC)	14093	15972	17617	20425	
Rectangular	1400x700mm (06AD)	14190	16082	17739	20547	
Rectangular	1500x750mm (06AE)	14676	16633	18346	21154	
Rectangular	1600x795mm (06SG)	N/A	N/A	N/A	N/A	
Rectangular	1600x800mm (06AF)	14984	16982	18731	21539	
Rectangular	1800x750mm (06AG)	15291	17331	19116	21924	
Rectangular	1800x795mm (06TA)	N/A	N/A	N/A	N/A	
Rectangular	1800x800mm (06AH)	15615	17698	19521	22329	
Rectangular	1800x900mm (06AI)	16020	18157	20027	22835	
Half-round	1400x700mm (06BB)	14676	16633	18346	21154	+862
Half-round	1500x750mm (06BC)	14984	16982	18731	21539	
Half-round	1600x800mm (06BD)	15405	17459	19258	22066	

Price list 2023 - SEK excl. V.A.T. - Version 1.2

# Tempest fix

By KOMPLOT Design

Detail is everything. It is why the Tempest flips, rolls and unfolds possibilities like no other table system in the world.

- 10 year warranty
- Inverted elliptical T-leg style
- Legs: concealed wheel + adjustable glides
- GreenTag<sup>Cert™</sup>
- FSC certified
- ISO 14025 EPD



	Laminate (T12)	Linoleum (T14)	Veneer (T13)	Stained veneer (T13)																						
<p>Melamine, laminate and linoleum are with matching ABS edge. Veneer is with matching hardwood edge. Other RAL colours available - ASK HOWE</p> <p>Table top thickness: Melamine is 25mm. Laminate, linoleum and veneer is 27mm.</p>	L42 L43 L50 L55 L310 L420 L110 L600 L500 L210 SEK	FL200 SEK	V1 V2 V3 V5 V12 V13 V15 SEK	LW17 LW25 LW30 SEK	Linking																					
	<table border="1"> <tr> <td>Crescent</td> <td>1200x750mm (06AW)</td> <td>18888</td> <td>21406</td> <td>23611</td> <td>26419</td> </tr> <tr> <td>Crescent</td> <td>1400x700mm (06AY)</td> <td>19843</td> <td>22489</td> <td>24806</td> <td>27614</td> </tr> <tr> <td>Crescent</td> <td>1500x750mm (06AZ)</td> <td>20605</td> <td>23352</td> <td>25758</td> <td>28566</td> </tr> <tr> <td>Crescent</td> <td>1600x800mm (06BA)</td> <td>21982</td> <td>24913</td> <td>27479</td> <td>30287</td> </tr> </table>	Crescent	1200x750mm (06AW)	18888	21406	23611	26419	Crescent	1400x700mm (06AY)	19843	22489	24806	27614	Crescent	1500x750mm (06AZ)	20605	23352	25758	28566	Crescent	1600x800mm (06BA)	21982	24913	27479	30287	+1724
Crescent	1200x750mm (06AW)	18888	21406	23611	26419																					
Crescent	1400x700mm (06AY)	19843	22489	24806	27614																					
Crescent	1500x750mm (06AZ)	20605	23352	25758	28566																					
Crescent	1600x800mm (06BA)	21982	24913	27479	30287																					
	<table border="1"> <tr> <td>Trapezoid</td> <td>1500x750mm (06BE)</td> <td>15146</td> <td>17165</td> <td>18934</td> <td>21742</td> </tr> <tr> <td>Trapezoid</td> <td>1600x800mm (06BF)</td> <td>15534</td> <td>17606</td> <td>19420</td> <td>22228</td> </tr> </table>	Trapezoid	1500x750mm (06BE)	15146	17165	18934	21742	Trapezoid	1600x800mm (06BF)	15534	17606	19420	22228	N/A												
Trapezoid	1500x750mm (06BE)	15146	17165	18934	21742																					
Trapezoid	1600x800mm (06BF)	15534	17606	19420	22228																					
	<table border="1"> <tr> <td>V-Shape</td> <td>1500x750mm (06BQ)</td> <td>16717</td> <td>18946</td> <td>20898</td> <td>23706</td> </tr> </table>	V-Shape	1500x750mm (06BQ)	16717	18946	20898	23706	N/A																		
V-Shape	1500x750mm (06BQ)	16717	18946	20898	23706																					

Price list 2023 - SEK excl. V.A.T. - Version 1.2

# Tempest modesty panel

By KOMPLOT Design

Detail is everything. It is why the Tempest flips, rolls and unfolds possibilities like no other table system in the world.

- 10 year warranty
- FSC certified



		Laminate	Linoleum	Veneer
		9 mm	9 mm	9 mm
<b>MODESTY PANEL - Hook</b>		L42 ● L43 ● L50 ● L55 ● L310 ● L420 ● L110 ● L600 ● L500 ● L210 ●	FL200 ●	V1 ● V2 ● V3 ● V5 ● V12 ● V13 ● V15 ●
Rectangular modesty panel, on hooks, panel height 250 mm. Suite for rectangular flip-top or fixed tables. *standard colour, same as tabletop		SEK	SEK	SEK
Rectangular	700 mm (FMFM)	2902	3991	4105
Rectangular	750 mm (FNFN)	2902	3991	4105
Rectangular	800 mm (DADA)	2902	3991	4105
Rectangular	1200 mm (DEDE)	3185	4387	4501
Rectangular	1400 mm (DGDG)	3468	4769	4912
Rectangular	1500 mm (DHDH)	3751	5166	5308
Rectangular	1600 mm (DIDI)	3751	5166	5308
Rectangular	1800 mm (DKDK)	3751	5166	5308
<b>MODESTY PANEL - Demountable</b>		Laminate	Linoleum	Veneer
Rectangular modesty panel, on hooks, panel height 250 mm. Suite for rectangular flip-top or fixed tables. *standard colour, same as tabletop		20 mm	20 mm	20 mm
Rectangular	700 mm (FMFM)	3142	3935	4006
Rectangular	750 mm (FNFN)	3142	3935	4006
Rectangular	800 mm (DADA)	3142	3935	4006
Rectangular	1200 mm (DEDE)	3453	4331	4402
Rectangular	1400 mm (DGDG)	3567	4473	4558
Rectangular	1500 mm (DHDH)	3680	4614	4700
Rectangular	1600 mm (DIDI)	3680	4614	4700
Rectangular	1800 mm (DKDK)	3807	4756	4841

Price list 2023 - SEK excl. V.A.T. - Version 1.2



# Tempest modesty panel

By KOMPLOT Design

Detail is everything. It is why the Tempest flips, rolls and unfolds possibilities like no other table system in the world.

- 10 year warranty
- FSC certified

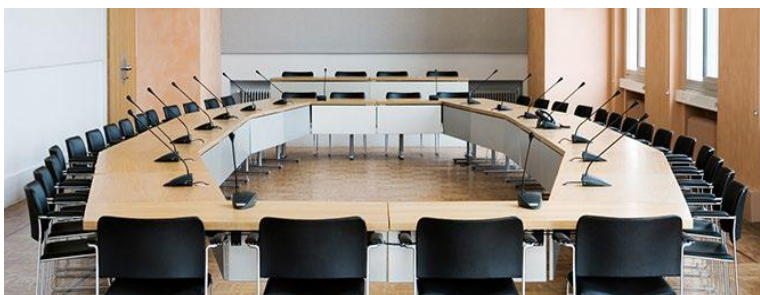

Acrylic  
4 mm

## MODESTY PANEL

Rectangular modesty panel, on hooks,  
panel height 250 mm.  
Suitable for rectangular flip-top or fixed tables.



SEK

Rectangular	700 mm (FMFM)	2477
Rectangular	750 mm (FNFN)	2477
Rectangular	800 mm (DADA)	2477
Rectangular	1200 mm (DEDE)	2930
Rectangular	1400 mm (DGDG)	3454
Rectangular	1500 mm (DHDH)	3454
Rectangular	1600 mm (DIDI)	3454
Rectangular	1800 mm (DKDK)	3454

Price list 2023 - SEK excl. V.A.T. - Version 1.1



















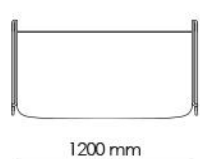
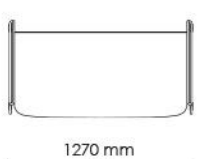

# Tutor

By John Bollen

This stackable table pays tribute to the iconic 40/4 chair, and in the process, becomes an icon itself.

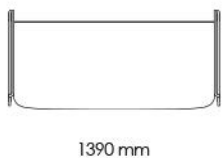
- Up to 30 tables can be stacked on dolly
- Up to 10 tables can be stacked on floor
- Use in education and training establishments
- 5 year warranty
- **Quick ship - LINK**

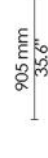

		Compact Laminate (OFA)				
Table top thickness is 6 mm bendable compact laminate. Other compact laminate colours: ask HOWE Other RAL colours - ask HOWE		F300  F200 	With felt glides (F)			
 B1 B7 B9 B10 B30		SEK	SEK			
 Single table	 600 mm 23.6"	 670 mm 26.4"	 665 mm 26.2"	 720 mm 28.3"	 800 mm 31.5"	 905 mm 35.6"
600 mm (AA)	5215	5337				
 Double table	 1200 mm 47.2"	 1270 mm 50"	 665 mm 26.2"	 720 mm 28.3"	 800 mm 31.5"	 905 mm 35.6"
1200 mm (BA) *Suitable for side chairs	9579	9701				
 *Double table	 1390 mm 54.7"	 1460 mm 57.5"	 665 mm 26.2"	 720 mm 28.3"	 800 mm 31.5"	 905 mm 35.6"
1390 mm (CA) *Suitable for armchairs and swivel chairs	11578	11700				

Price list 2023 - SEK excl. V.A.T. - Version 1.1

Net price: RAL K5 colours for frame - see notes







# Usu

By HOWE in-house design team

Usu is a study of simplicity in both form and function. The intuitive folding mechanism and transporter, with room for ten rectangular and square tables, make Usu easy to move.

- 5 year warranty
- Up to 10 rectangular and square tables stacked on a transporter
- Stylish round 4-leg design
- FSC certified
- Design for disassembly

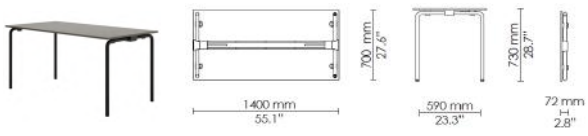

Laminate is standard with matching ABS edge. Table top thickness is 18mm. Standard frame with 2 glides and 2 castors. Linking is incl. 2 brackets		Laminate (UF2)
 <p>B1** B7*</p> <p>*Due to the technological process, the black may slightly differ in terms of its gloss.</p>		<p>L310 </p> <p>L420 </p> <p>L110 </p> <p>L600 </p> <p>L500 </p> <p>L210 </p>
		SEK
Rectangular	1200x600mm (AAAA)	8595
Rectangular	1400x700mm (ADAD)	9465
Rectangular	1600x800mm (AFAF)	9792
Square	800x800mm (CACA)	8595
Round	Ø1200mm (BVBV)	11097

Price list 2023 - SEK excl. V.A.T. - Version 1.1

Linking	+87	SEK
** Chrome base	+653	SEK







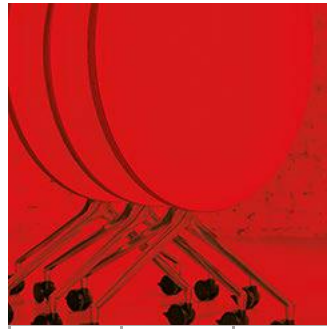

# AS400

By Andreas Störiko

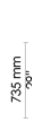
The AS series is highly inspired and highly functional. Combining elegance and utility with true mobility, the family of nesting chairs and tables leaves room for all imaginable purposes.

- 10 year warranty
- Café height tables
- Unbelievably easy to manoeuvre
- Intuitive flip-top mechanism
- Special handle allows to lift the AS tables
- Smart elastic cord firmly joins concave tables
- Rubber bumper protects tables from scratches
- An infinite number of tables can then be nested together

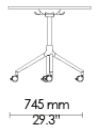

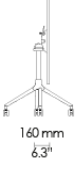
		Laminate (AB2)	Linoleum (AB4)	Veneer (AB3)
Laminate are with matching ABS edge. Linoleum and veneer are with non-matching, transparent lacquer. Other RAL colours available - ASK HOWE Standard base colours: B6 B7 B31 B51	L42 L43 L310 L420 L110 L600 L500 L210	● ● ● ● ● ● ● ●	FL200 ●	V2 ● V3 ●
		SEK	SEK	SEK
	 640 mm 25.2"	 745 mm 29.3"	 735 mm 29"	 160 mm 6.3"
Square	640 x 640 mm (tiny pre-drills in the top; possibility to order linking later)	9143	12484	13559
Square with link	640 x 640 mm	9709	13050	14125
	 830 mm 32.7"	 745 mm 29.3"	 735 mm 29"	 160 mm 6.3"
Round	Ø830mm	9143	12484	13559
Concave with link	Ø830mm	9899	13299	14433

Price list 2023 - SEK excl. V.A.T. - Version 1.1

Transparent lacquer on plywood core for laminate or nano-laminate	+2123 SEK
Soft lane castors	+127 SEK

# AS500

By Andreas Störko

The AS series is highly inspired and highly functional. Combining elegance and utility with true mobility, the family of nesting chairs and tables leaves room for all imaginable purposes.

- 10 year warranty
- Bar height tables
- Unbelievably easy to manoeuvre
- Intuitive flip-top mechanism
- Special handle allows to lift the AS tables
- Smart elastic cord firmly joins concave tables
- Rubber bumper protects tables from scratches
- An infinite number of tables can then be nested together



	Laminate (AD2)	Linoleum (AD4)	Veneer (AD3)	
Laminate are with matching ABS edge. Linoleum and veneer are with non-matching, transparent lacquer. Other RAL colours available - ASK HOWE Standard base colours: B6 B7 B31 B51	L42 L43 L310 L420 L110 L600 L500 L210	FL200	V2 V3	
	SEK	SEK	SEK	
Square (tiny pre-drills in the top; possibility to order linking later)	600 x 600 mm	9795	13234	14366
Square with link	600 x 600 mm	10361	13800	14932
Round	Ø700 mm	9795	13234	14366

Price list 2023 - SEK excl. V.A.T. - Version 1.1

Transparent lacquer on plywood core for laminate or nano-laminate +2123 SEK

Soft lane castors +127 SEK

# Accessories

## Tables' transporters

HOWE combines simplicity and functionality with a focus on timeless originality. In every moving detail. This is why our furniture stacks, folds, rolls and creates flexible solutions like no other designs in the world.



<b>Tempest Flip-top</b>		Per Piece	
Capacity up to 5 tables standing up (flipped position). Dimensions: 960 mm high, 2000 mm long and 915 mm wide. MDF platform, metal powdercoated in B10 Howe grey.			
	SEK		
Transporter	Tempest	26355	
<b>Tempest Fold</b>		Per Piece	
Capacity: up to 10 pcs Stacks on table edge, secured with straps. Top against top - base against base. Colour B10 Howe grey. Dimensions: 1131 mm high x 2010 mm long x 562 mm wide Suitable for length 1200-1800 mm and width 600-900 mm.			
	SEK		
A-kit big	Tempest	13056	
<b>Only USU</b>		Per Piece	
Capacity: up to 10 pcs Stacks on table edge, secured with strap. Colour: black Height: 1125 mm, length: 1155 mm, depth: 450 mm. The dimensions are without tables on the transporter. Suitable for rectangular and square tables 800-1800 mm long and 500-900 mm wide			
	SEK		
Usu dolly	Usu	11968	
<b>Tempest Fold</b>		Per Piece	
Capacity w/rectangular tables: up to 5 pcs Capacity w/ all other shapes: up to 5 pcs Stacks on table edge, secured with straps. Top against top - base against base. Colour B10 Howe grey. Dimensions: 1255 mm high x 2010 mm long x 775 mm wide Suitable for length 2000-2400 mm and width 1000-1200 mm (when rectangular).			
	SEK		
L-kit	Tempest	17466	



Price list 2023 - SEK excl. V.A.T. - Version 1.1

# Accessories

## Tables' transporters cont.

HOWE combines simplicity and functionality with a focus on timeless originality. In every moving detail. This is why our furniture stacks, folds, rolls and creates flexible solutions like no other designs in the world.



<b>Simpla</b>		Per Piece		
Capacity up to 8 tables. Colour B10 Howe grey. Dimensions: height 1895, depth 840, adjustable width Suitable for rectangular tables: length 1000-1800 and width up to 900 mm. For other shapes and sizes, please ask HOWE.				SEK
Transporter	Simpla			22052
<b>Tutor single size</b>		Per Piece		
Capacity up to 30 tables. Suitable for single size Tutor tables. Colour B10 Howe grey.				SEK
Transporter	Tutor			13234
<b>Tutor double size</b>		Per Piece		
Capacity up to 30 tables. Suitable for double size Tutor tables. Colour B10 Howe grey.				SEK
Transporter	Tutor			17777

Price list 2023 - SEK excl. V.A.T. - Version 1.1

# Accessories

## AS tables privacy screens

Aesthetically pleasing, the innovative felt privacy screen creates enclosure to spaces during work, education, and meeting areas. It gives flexibility to produce boundaries, as well as visual privacy.



<b>Privacy screen</b>		Per Piece	
Privacy screen for AS round and round concave tables. 1188x350 mm; 12 mm thick; light grey felt			
Screen	66091001	SEK	
		4896	

Price list 2023 - SEK excl. V.A.T. - Version 1.1



# Notes for tables

Price list 2023 - SEK excl. V.A.T. - Version 1.1

## General

---

HOWE standard delivery times in EU are usually: Chairs 4-6 weeks, Tables 5-7 weeks.

In case of large quantities and/or customized products delivery time will be determined on a case-by-case basis.

The following products may have a slightly longer lead time so please ask HOWE:

- Simpla: Trapezoidal
- Tutor: 1390 mm double table (for armchairs and swivel chairs), F200 black tabletop

In case of using any electrification, accessories, or making configurations, the lead time starts being counted once technical drawings are approved by the customer.

## Moveo

---

Moveo linking for rectangular and V-shaped tables includes 4 brackets and 4 fittings. Moveo linking for half-round and half-boat tables includes 2 brackets and 2 fittings. This type of linking is available for tables with straight edges only. Another linking type is available for tables with chamfered edges. Here you also get 4 brackets and 4 fittings for rectangular and V-shape tables as well as 2 brackets and 2 fitting for half-round and half-boat tables.

All RAL colours from RAL K5 colour card available. For quantities < 20 tables the colour fee is 2620 SEK per RAL colour. For quantities ≥ 20 tables there is no fee. Visual impression of particular RAL may differ on various surfaces. Preparing product's sample(s) is compulsory. Lead time to be confirmed by HOWE CS.

## Simpla

---

Please note that Simpla linking does not need any pre-drills and may be ordered at any time as a separate accessory.

Please note that Modesty panels for Simpla are just hanged on the frame and may be ordered at any time as a separate accessory.

All RAL colours from RAL K5 colour card available. For quantities < 50 tables the colour fee is 2620 SEK per RAL colour. For quantities ≥ 50 tables there is no fee. Visual impression of particular RAL may differ on various surfaces. Preparing product's sample(s) is compulsory. Lead time to be confirmed by HOWE CS.

## Tempest

---

Tempest linking for rectangular, crescent, and square tables includes 4 brackets and 4 fittings. Tempest linking for half-round tables includes 2 brackets and 2 fittings. This type of linking is available for tables with straight edges only. Another linking type is available for tables with chamfered edges. Please contact HOWE for options.

All RAL colours from RAL K5 colour card available. For quantities < 20 tables the colour fee is 2620 SEK per RAL colour. For quantities ≥ 20 tables there is no fee. Visual impression of particular RAL may differ on various surfaces. Preparing product's sample(s) is compulsory. Lead time to be confirmed by HOWE CS.

## Usu

---

Please note that Usu linking may be ordered at any time as a separate accessory.

## Tutor

---





















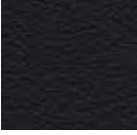











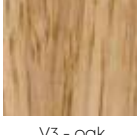
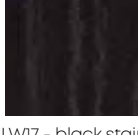
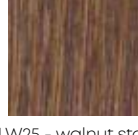
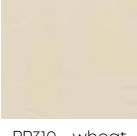

All RAL colours from RAL K5 colour card available. For quantities < 50 tables the colour fee is 2620 SEK per RAL colour. For quantities ≥ 50 tables there is no fee. Visual impression of particular RAL may differ on various surfaces. Preparing product's sample(s) is compulsory. Lead time to be confirmed by HOWE CS.

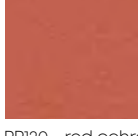
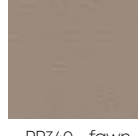
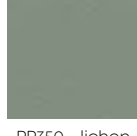
**Tutor**

---

All RAL colours from RAL K5 colour card available. For quantities < 50 tables the colour fee is 2620 SEK per RAL colour. For quantities  $\geq$  50 tables there is no fee. Visual impression of particular RAL may differ on various surfaces. Preparing product's sample(s) is compulsory. Lead time to be confirmed by HOWE CS.

# Finish selection - Chairs

40/4 Seats / backs Natural wood veneers							
	V1 - maple	V2 - beech	V3 - oak	V5 - cherry	V12 - ash EMEA ONLY	V13 - birch EMEA ONLY	V15 - walnut
40/4 Seats / backs Stains				All RAL colours available based upon customer sample			
	LW17 - black	LW30 - white	Any RAL				
40/4 Seats / backs Polyamide							
	PA200 - black	PA100 - Howe grey	PA300 - coconut	PA110 - Ayers Rock red	PA260 - marine blue		
							
	PA360 - olive green	PA320 - mandarin	PA250 - blue eyes	PA370 - mint turquoise	PA380 - aubergine		
40/4 Seats / backs Metal					All RAL colours available based upon customer sample		
	ME200 - black	ME300 - white	ME110 - red EMEA ONLY	Any RAL			
40/4 WOOD FRAME Seats / backs Natural wood veneers / stains							
	V2 - beech	V3 - oak	LW17 - black stain	LW25 - walnut stain			
SixE Shells Polypropolyne							
	PP310 - wheat	PP270 - ocean	PP120 - red ochre	PP340 - fawn	PP350 - lichen		
							
	PP200 - black	PP100 - Howe grey	→ HOWE GREY SHELL AVAILABLE AS 100% RECYCLED	PP300 - chalk	PP110 - Ayers Rock red	PP250 - blue eyes	PP360 - olive green

MN1  
Backs  
Natural wood  
veneers / stains



V3 - oak



LW17 - black stain



LW25 - walnut stain

THE TONGUE  
Shells  
Natural wood  
veneers / stains



V3 - oak



V15 - walnut



LW17 - black stain

MUNKEGAARD CHAIR  
Shells  
Natural wood  
veneers / stains



V3 - oak



V15 - walnut



LW17 - black stain

40/4  
SIXE  
Frames  
Steel

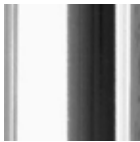

B1 - chrome



B6 - satin black



B7 - black



B9 - alu grey



B10 - Howe grey



B30 - white



Any RAL

All RAL colours  
available based  
upon customer  
sample

SIXE SWIVEL  
SIXE LEARN  
Base  
Polyamide



PA100 - Howe grey

SIXE SWIVEL  
SIXE LEARN\*  
Swing arm\*  
Gas lift

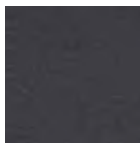

B10 - Howe grey

MN1  
Bases

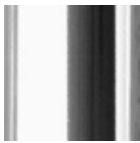

B1 - chrome



B7 - black



B51 - polished alu

THE TONGUE  
MUNKEGAARD CHAIR  
Frames  
Steel



B1 - chrome



B7 - black



B30 - white

AS100  
Bases / seat frames



B6 - satin black



B7 - black



B51 - polished alu

# CHAIRS



# Finish selection - Tables EMEA

AS TABLES  
MOVEO  
SIMPLA  
TEMPEST

Tops  
Natural wood  
veneers / Stains



V1 - maple      V2 - beech      V3 - oak      V5 - cherry      V12 - ash



V13 - birch      V15 - walnut

AS tables standard:  
V2 beech, V3 oak ONLY



LW17 - black stain      LW25 - walnut stain      LW30 - white stain      Any RAL

All RAL colours available  
based upon customer sample

AS TABLES  
MOVEO  
SIMPLA  
TEMPEST

Tops  
Wood grain  
laminates



L42 - beech      L43 - oak      L55 - walnut      L50 - grey oak

AS tables standard:  
L42 beech, L43 oak ONLY

AS TABLES  
MOVEO  
SIMPLA  
TEMPEST  
USU

Tops  
Coloured  
laminates

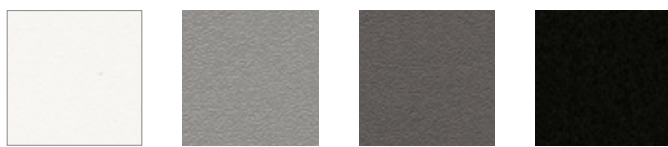

L310 - white      L420 - grey      L110 - Howe grey      L210 - black

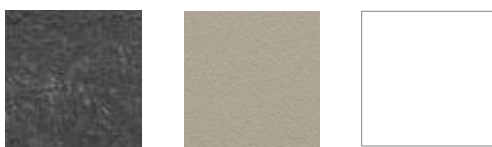

L500 - metal slate      L600 - stone grey      Any coloured laminates\*

\*Any coloured laminates  
does not apply to Usu

AS TABLES  
MOVEO  
SIMPLA  
TEMPEST

Tops  
Coloured  
nano laminates



NL350 - eggshell white      NL450 - warm grey      NL200 - black



# TABLES

## EMEA



MOVEO  
SIMPLA  
TEMPEST  
USU  
Tops  
Melamines



M310 - white

TUTOR  
Tops  
Bendable  
compact  
laminates



F300 - white



F200 - black



Any bendable  
compact laminate

AS TABLES  
MOVEO  
SIMPLA  
TEMPEST  
Tops  
Linoleums

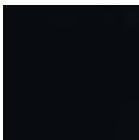

FL200 - black

SIMPLA  
TUTOR  
Bases  
Steel



B1 - chrome



B7 - black



B9 - alu grey

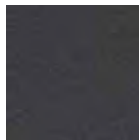

B10 - Howe grey



B30 - white

TEMPEST  
Bases  
Steel



B1 - chrome



B6 - satin black

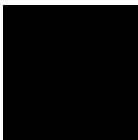

B7 - black



B9 - alu grey

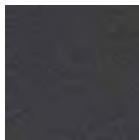

B10 - Howe grey



B30 - white

USU  
Bases  
Steel



B1 - chrome

MOVEO  
Bases  
Aluminum

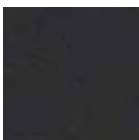

B6 - satin black



B51 - polished alu



B52 - anodized alu

AS TABLES  
Bases

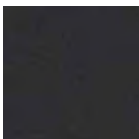

B6 - satin black

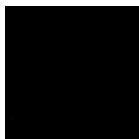

B7 - black



B31 satin white  
- columns only



B51 - polished alu  
- bases only



COLOUR REFERENCE ONLY  
Variations in colours and structures may occur.

Subject to ongoing changes and adjustments.

JULY 2023

[howe.com](http://howe.com)