



KARL ANDERSSON & SÖNER  
SINCE 1898

CIRKAPRISLISTA SEK EXKL MOMS & FRAKT  
1 MARS 2023 - 28 FEBRUARI 2024

VERS.1



KARL ANDERSSON & SÖNER  
125  
1898-2023  
HANDMADE IN HUSKVARNA



## INNEHÅLL CONTENT

### BORD TABLE

79 Bat  
74 Bouquet  
42 Brygga  
75 Buff  
52 Cap bord table  
78 Cap podium  
81 Eight  
51 Kanecct  
58 Locus  
76 Lollipop  
80 Mill  
81 Mopsy  
84 Newton  
62 Pivå  
66 ponoq  
43 Press  
81 Puddle  
47 Rollo  
50 Study  
67 Tailor  
82 Terrane  
73 Thinner  
83 Trayo  
84 Trio  
69 Trippo  
56 Woodwork

### FÖRVARING STORAGE

8 2K-skåp  
20 Alva  
16 Cavetto  
21 Cubebrick  
30 Front hylla shelf  
6 KA72  
20 Level  
14 May  
12 Mrs Bill  
20 Part  
41 Ray  
19 Sign  
15 Stow  
23 Trippo  
11 Upper

### EXPONERINGSSYSTEM DISPLAY

28 1KM Display  
27 Arc  
27 Collar  
27 ELL  
36 Front fristående free-standing  
6 KA72  
35 Front förvaring storage  
30 Front hylla shelf  
26 Front klådhängare coat hanger  
29 Front list ledge  
31 Front monterskåp display cabinet  
32 Front panel  
30 Front plant  
31 Front tavla board  
20 Part  
41 Ray  
38 Ridå  
40 Slope  
28 Svall

### KLÅDHÄNGARE COAT HANGER

25 Chess  
26 Front  
25 Knob  
25 Nest  
26 ponoq  
23 Trippo

### SITTMÖBLER SEATING

88 Colo Chair  
98 Facile  
90 Hygge  
100 Kamón  
87 Kaz  
94 Meander  
86 Milo  
96 Ondulé  
91 Sander Conference  
93 Sander Lounge  
85 Shell Pall Stool  
89 Shell Stol Chair  
67 Tailor bänk bench

### PROVER SAMPLE

4 Prover Trä Laminat  
Samples Wood Laminat  
5 Tyg Läder Filt  
Fabric Leather Felt

### NEWS 2023

Locus Bord Table  
Rollo H900mm  
Sander Conference  
Sander Lounge  
Cap Podium special  
Ray with Carpet Solvig from Stoddard

# FÖRSÄLJNINGSVILLKOR

**Priser:** Angivna priser är i SEK, exklusive mervärdesskatt.

**Leveransvillkor:** fritt fabrik inkl. standardemballage.

**Frakt** till återförsäljarens lager inom Sverige debiteras med följande %-sats baserat på nettovärde. Tillägg för telefonavisering och direktleverans till företag tillkommer med 120 SEK exkl. moms. Kostnad för tidslossning tillkommer. Direktleverans till privatkund sker ej.

Inom Sverige gäller följande tariffer från Huskvarna:  
Fraktavstånd upp till 500 km 7% minimum 660 SEK exkl.moms  
Fraktavstånd upp till 501-1000 km 11% minimum 1110 SEK exkl.moms  
Fraktavstånd över 1001 km 12% minimum 1500 SEK exkl.moms

**Lastpall kostnad per styck, netto exkl. moms:** 120x80, 160x80cm 120SEK. 200x80, 240x80cm 280SEK. Pallkrage 90SEK

**Transportskada:** Vid mottagning av gods är alltid mottagaren ansvarig att avsyna godset både ut- och invändigt. Skada på emballaget ska noteras på fraktsedeln med kvittens från chauffören. Följ anvisningar på fraktsedeln. **Om anvisningar inte följs utgår ingen ersättning för transportskada.** Vid förlust eller saknad av kolla kontakta transportören.

**Returer:** Returer får ej ske utan vårt godkännande.

**Betalning:** 30 dagar netto från fakturadatum eller enligt överenskommelse. Sald vara är vår egendom tills full betalning är erlagd. Efter förfallodatum debiteras dröjsmålsränta med 1,5% per månad enligt uppgift på offert/orderbekräftelse/faktura.

**Garanti:** Garanti gäller mot fabriktions- och materialfel. Garantitiden på levererat gods är två år från fakturadatum. Åtgärder bedöms individuellt.

**Administrationsavgift:** Order under 1550 SEK brutto exkl. moms utgår en administrationsavgift på 60 SEK.

**Övrigt:** Vi förbehåller oss rätten till ändringar i kollektion, priser eller konstruktion. All information i denna prislista, inklusive måttuppgifter, material och priser kan bli ändrade utan föregående avisering. Tidigare prislister och försäljningsvillkor annulleras härmed.

**Utförande:** För varje artikel är standardutförande angivet i prislistan. Mått är i millimeter (mm). L=längd, B=bredd D=djup, H=höjd, ø=Diameter.

**Ytbehandling:** Ytbehandling är halvmatt syrahärdad lack. Deklarerade produkter enligt Möbelfakta är ytbehandling vattenbaserad lack. Avvikelse i utförande eller ytbehandling mot tillägg.

**Standard färger:** Lack (50) finns i följande standard färger svart (.58), gul(.62), röd(.67), grön(.74), snövit(.81), vit(.82), grå(.84), antracit(.86) uppgge rätt färgnummer vid beställning se NCS-beteckningar på sid 4.

**Special färger:** Specialfärger enligt NCS kan erhållas mot ett tillägg av 2650 SEK per färg och order.

**Standardbets:** Standardbets är svart(.11), wenge(.12) snövit(.13), rödbrun(.14), grön(.15), röd(.16), blå(.17), brun(.18), grå(.19), antracit(.20), valnöt (.21) Betsning sker på ek eller ask om inget annat anges. Uppge rätt färgnummer vid beställning se NCS-beteckningar på sid 4.

**Specialbets:** Vissa produkter kan erhållas i bets enligt förfrågan. Bets tillägg tillkommer med 15% + startkostnad 2650 SEK.

**Vitpigment:** .25 vitpigment på ask och .26 vitpigment på ek. Pristillägg lika som standardbets.

**Läder:** Standardläder se sidan 5. För klädsel i insänt läder tillkommer extra klädselkostnad enligt offert.

**Tyg:** Standard tyger i respektive prisgrupp på sid. 5. Vid tyger med mönsterpassning samt vid avtagbar klädsel ökar tytgången. Fråga oss om detaljerade uppgifter per modell. För insänt tyg är kostnad 790 SEK.

**Skötselråd:** Läs om hur du vårdar din möbel på [karl-andersson.se](http://karl-andersson.se) | OM KA | SKÖTSELRÅD | VÅRDA DIN MÖBEL

**Trä:** Trä är ett levande naturmaterial och har därför varierande teckningar och olika utseende. Detta är ett kvalitetsbegrepp och ej föremål för reklamationer.



MÖBELFAKTA

Produkter som innehar möbelfakta är: Arc, Cap, Collar, Colo Chair, Ell, Facile, Front list, Front panel, Front fristående, Hygge, Kamón Dinner Lounge och Bänk, Kanecct, Kaz, Locus, Meander, Milo, Ondulé, Part, Pivá, Press med träben höjd 725mm, Ridå vägghängd, Ray, Rollo, Sander Lounge och Conference obs! endast träben, Shell pall, Shell stol, Slope, Study, Tailor, Woodwork. Dessa produkter är ytbehandlade med vattenbaserad lack. Om syrahärdad lack önskas ska detta framgå på order.

# CONDITIONS OF SALE

**Prices:** The prices are in SEK. Taxes, etc are not included.

**Delivery:** Ex Works incl. standard packaging.

**Freight** to the retailer's warehouse is paid by Karl Andersson & Söner AB and debited at a nominal rate of the invoiced value of the goods supplied. VAT will be added. Surcharge for telephone notification of delivery charged by 120 SEK. Cost of appointment of deliver is added. Direct deliveries to private consumer will only be on reseller's freight agreement.

**Pallet per each, net excl. VAT:** 120x80, 160x80cm 120SEK. 200x80, 240x80cm 280SEK. Pallet collar 90SEK.

**Transport damage:** When receiving packages, the recipient is always responsible to check the packages' condition, outside and inside. Damages of the package have to be noted on the consignment note with a signature from the driver. Follow the instructions on the consignment note. **If you do not follow the instruction on the consignment, no payment for damages will be paid.** If a package is lost or missing, contact the freight forwarder.

**Returns:** Return may not be made without our prior approval.

**Payment:** Prepayment unless otherwise agreed. Goods sold remain the property of Karl Andersson & Söner AB until full payment has been received. After the due date for payment, unsettled accounts will be charged with penalty interest in accordance with the terms stated on the order confirmation/invoice. Payment methods are IBAN and SWIFT (no checks or credit cards accepted).

**Limited Warranty:** Goods are guaranteed against manufacturing faults and material defects for a period of two years from the date of invoice. The measures taken to rectify the situation will be decided on a case-to-case basis.

**Administration Fee:** For orders less than SEK 1550 gross, excl. VAT, an administration fee of SEK 60 will be charged.

**Other terms:** We reserve the right to make changes to the range, to prices and to designs. All the information provided, including measurements, material and prices are approximate and can be subject to change without prior notice. This notice supersedes all earlier pricelists and conditions of sale.

**Finishes:** The pricelist shows the standard finish for each article. Dimension in millimeter (mm). L=length, B=width, D=depth, H=height, ø=Diameter.

**Surface treatment:** The standard surface finish is acid-hardened, semi-matt plastic lacquer. Products that holds Möbelfakta have water-based treatment. Other finishes or surface treatment are available at a supplement.

**Standard colors:** Lacquer (50) is available in standard colors of black (58), yellow(62), red(67), green(74), snow white (81), white (82), anthcite(86), gray(84). Please state the correct color code when ordering. NCS-code see page 4.

**Special colors:** Special colors are available for a surcharge of SEK 2650 per color/per order.

**Standard stains:** Standardstain is black(.11), wenge(.12), snow white(.13.), red brown(.14), green(.15), red(.16), blue(.17), brown(.18), gray(.18), anthracite(.20), valnöt (.21). Stain is on oak or ash if nothing else says. Please state the correct color code when ordering. NCS-code see page 4.

**Special stains:** Certain products may be supplied in a stained finish on request. In such instances a surcharge is made equivalent to 15% of the order value + a start-up cost of SEK 2650.

**White glaze:** .26 white pigment on ash and .25 white pigment on oak. Extra cost same as standard stain.

**Leather:** Standard leather see page 5. Customers may also request a quotation for the cost of covering furniture in leather provided by the customer.

**Fabrics:** See the fabrics in the various price groups on page 5 For removable fabric and for pattern fitting, extra fabric is required. Contact us for detailed information. Cost for covering furniture with the customer's own fabric SEK 790. Make order of fabric samples directly from the producer.

**Furniture Care:** Read about how to take of your furniture at [karl-andersson.se](http://karl-andersson.se) | ABOUT KA | FURNITURE CARE | TAKING CARE OF YOUR FURNITURE

**Wood:** Wood is a living material with natural variations in hue and grain pattern. Any slight differences in appearance are an indication of genuine quality and do not form the basis of a cause for complaint.



MÖBELFAKTA

Products that holds Möbelfakta are Arc, Cap, Collar, Colo Chair, Ell, Facile, Front ledge, Front panel, Front free-standing, Hygge, Kanecct, Kamón Dinner, Lounge and Bench, Kaz, Locus, Meander, Milo, Ondulé, Part, Pivá, Press wooden legs height 725mm, Ray, Ridå wall mounted, Rollo, Sander Lounge and Conference note! only wooden legs, Shell stool, Shell chair, Slope, Study, Tailor, Woodwork. These products are standard surface waterbased. In case you want acid-hardened, semi-matt plastic lacquer please note on order.

# PROVER SAMPLES

Alla produkter finns ej i alla olika utförande. För mer information se under respektive produkt.  
Tänk även på att de tryckta proverna kan skilja sig i färg, struktur och nyans jämfört med levererad produkt.

All products are not available in all different versions. For more information please see under actual product.  
Also keep in mind that the printed samples can differ in color, texture and shades compared with delivered product.

## TRÅSLAG WOOD

Ytbehandling är klarlack i glansvärde 18, halvmatt. Alternativa ytbehandlingar olja, olja + lack kan erbjudas.  
Treated with clear lacquer in a no. 18 semi-matt finish. Other available finishes are oil or oil + lacquer.



.10 Ek Oak    .20 Björk Birch    .30 Ask Ash    .43 Körsbär Cherry

## STANDARDFÄRGER STANDARD COLORS

Glansvärde 35, halvblank. Alternativa färger kan erbjudas enligt NCS-skalan.  
Semi-gloss no. 35. Other colors are available in accordance with the NCS color system.



.62 Gul Yellow NCS S0580-Y    .67 Röd Red NCS 2070-Y80R    .74 Grön Green NCS S2010-G40Y    .81 Snövit Snow white NCS S0500-N    .82 Vit White NCS 0702-Y04R    .84 Grå Gray NCS S2500-N



.86 Antracit Anthracite NCS S7502-B    .58 Svart Black NCS S9500

## STANDARDBETSER STANDARD STAINS

Bets på ask eller ek om inget annat anges. Topplack är klarlack i glansvärde 18, halvmatt. Specialbetsar enligt insänt prov kan erbjudas.  
Stain on ash or oak if not otherwise specified. Top coat of clear lacquer in a no. 18 semi-matt finish. Special stains in accordance with samples sent to us are also available.



.11 Svart bets Black stain NCS S9500    .12 Wenge bets stain    .13 Snövit bets Snow white stain    .14 Rödbrun bets Red-brown stain    .15 Grön bets Green stain NCS S2010-G40Y    .16 Röd bets Red stain NCS S4050-Y80R



.17 Blå bets Blue stain NCS S5010-R90B    .18 Brun bets Brown stain NCS S8005-Y80R    .19 Grå bets Gray stain NCS S2500-N    .20 Antracit bets Anthracite stain NCS S7502-B    .21 Valnöt bets Walnut stain

## VITPIGMENT WHITE GLAZE

Vitpigment på ek eller ask om inget annat anges. Topplack är klarlack i glansvärde 18, halvmatt.  
White glaze on oak or ash if not otherwise specified. Top coat of clear lacquer in a no. 18 semi-matt finish.



.25 Vitpigment ask White glaze ash    .26 Vitpigment ek White glaze oak

## LAMINAT LAMINATE



.60 Vit White NCS S0502-G50Y    .61 Svart Black Fenix NTM 0720 Nero Ingo NCS S8500-N    .71 Ek Oak F5374 NAT    .72 Björk Birch F7555 MAT    .73 Ask Ash F8843 NAT

## DESKTOP

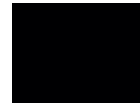

.90 Svart Black Forbo Nero col. 4023 NCS S9000-N

# TYGER LÄDER FABRIC LEATHER

Tyger Fabric				Läder Leather
Prisgrupp 1 Pricegroup	Prisgrupp 2 Pricegroup	Prisgrupp 3 Pricegroup	Prisgrupp 4 Pricegroup	Elmo Soft (EL)
Acton (VE)	Eliot (VE)	Be on (SV)	Auckland (VE)	99999 svart black
Avon (VE)	Europost 2 (GA)	Burton (VE)	Barnum (NV)	93068 brun brown
Blues CS (NV)	Focus (GA)	Canvas 2 (KV)	Breeze Fusion (GA)	22030 natur natural
Bond (GA)	Focus Melange (GA)	Crisp (GA)	Capture (GA)	33004 cognac
Creek* (VE)	Harper (SV)	Cyber (GA)	Divina 3 (KV)	
Easy (SV)	Illusion konstläder* (NV)	Focus Royal (GA)	Divina MD (KV)	
Gamut (VE)	Recheck (KV)	Grain (GA)	Divina Melange 2 (KV)	
Jemo* (VE)	Select (GA)	Hestan (VE)	Fiord 2 (KV)	
Leone* (VE)	Step (SV)	Illusion full grain* (NV)	Foster (VE)	
Lido (NV)		Mood (GA)	Hallingdal 65 (KV)	
Lido Trend (NV)		Morph (GA)	Lamu Recycled (VE)	
Malta* (VE)		Passion (GA)	Lani (VE)	
Margrethe (NV)		Re-wool (KV)	Memory 2 (KV)	
Peri (NV)		Rock (SV)	Poppy (SV)	
Pod CS (NV)		Tonus 4 (KV)	Raas (KV)	
Pop CS (NV)			Rami (SV)	
Puxx1&2* (Br Jörg)			Revolt (SV)	
Reflect (KV)			Steelcut Trio 3 (KV)	
Relate (KV)			Wolin (VE)	
Remix 3 (KV)				
Rock CS (NV)				
Scott* (VE)				
Step Melange (GA)				
Tone (SV)				
Vegas (NV)				
Wooly (NV)				
Wooly Plus (NV)				

Fabrikat/Supplier  
 BrJ=Bröderna Jörgensen SV=Ludvig Svensson  
 GA=Gabriel VE=Vescom  
 KV=Kvadrat EL=Elmo Leather  
 NE=Nevotex \*=artificial leather

## FILT FELT

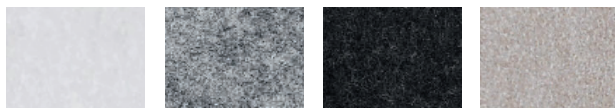

Offwhite  
Press  
Slope

Ljusgrå Light grey  
Ondulé  
Press  
Ridå  
Slope

Antracit Anthracite  
Ondulé  
Press  
Ridå  
Slope

Beige  
Ondulé



Fällbord Folding Table ROLLO | Stol Chair COLO CHAIR | Tidskriftsställ Magazine shelf ELL



Stol Chair COLO CHAIR | Bord Table PIVÅ | Rumsavdelare Room divider RAY | Sofa Sofa FACILE

# KA72 Göran Malmvall 1972

Skåp är av fanerad trälamell i ek, björk, ask, körsbär, standardfärger, standardbets på ask och vitpigment på ek och ask. Beslag är förnicklade eller i mässing. Sockel inkluderad med ställfötter (gäller ej bensockel artno BS73). Skåpen levereras ihopsatta. Ska skåp placeras fristående med synlig trärygg måste en ryggpanel beställas. Till skåpen finns olika tillbehör. Ange vid beställning: Beslag förnicklade eller mässing. Skåp B400 ange vänster eller högerhängd dörr, framifrån sett.

The cabinets are made of veneered blockboard in oak, birch, ash, cherry, standard colors, standard stains on ash and white glazed oak and ash. The fittings are nickel-plated or made of brass. Cabinets are supplied ready assembled with adjustable screws in the plinth (not for high base artno BS73). If the intention is to place the cabinet away from a wall, it is necessary to order a back panel to cover the back of the cabinet. There are various accessories for the cabinets.

Specify when ordering: Fittings nickel-plated or brass. Cabinet B400 enter left or right hung door, seen from the front.



Artno

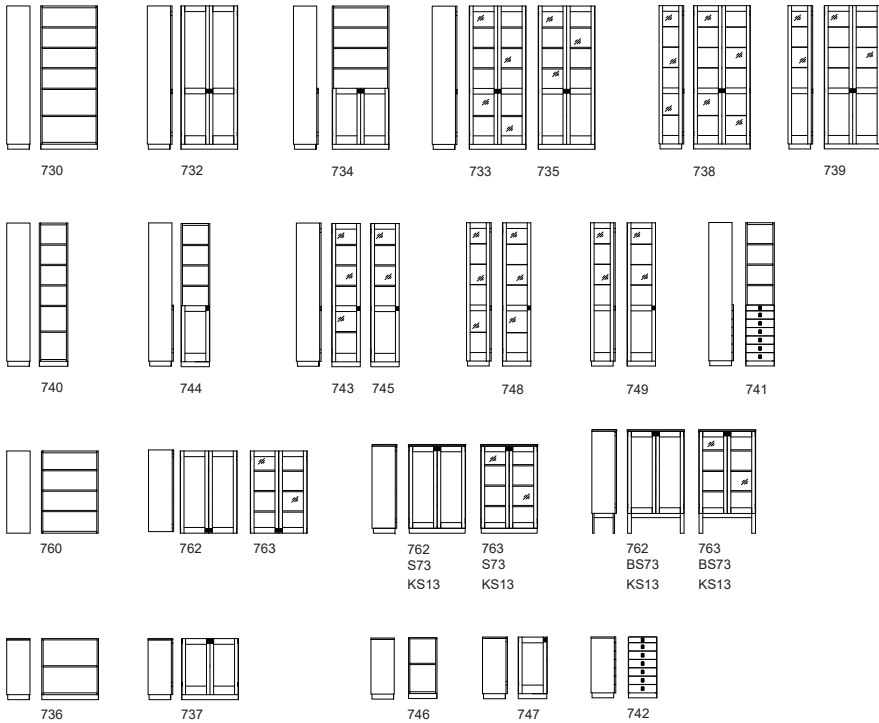

Tillbehör  
Accessories

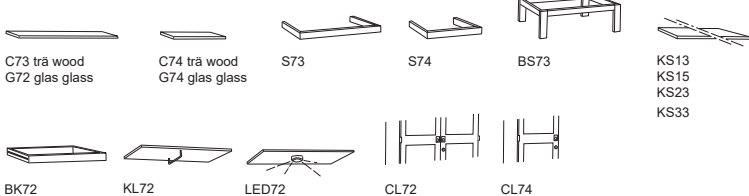

Tillbehör Accessories Artno	Bredd Width mm	Djup Depth mm	Höjd Height mm	KA72 SEK		Extra SEK	Vikt brutto Weight gross kilos
				.10 ek oak .20 björk birch .30 ask ash .50 lack color	.43 körsbär cherry	Standardbets på ask Standard stain on ash Vitpigment ek ask White glazed oak ash	
C73	760	320		1270	1270	+200	3
G72	760	320		1270 glas glass			3
C74	360	320		930	930	+140	2
G74	360	320		930 glas glass			2
S73	800	305	70	1040	1270	+160	2
S74	400	305	70	1040	1270	+160	2
BS73	800	305	280	4200	5230	+630	2
KS13	810	355	20	2370	2830	+360	3
KS15	1210	355	20	2930	3560	+430	7
KS23	1610	355	20	4230	5230	+630	7
KS33	2410	355	20	6410	7950	+960	10
BK72	725	330	70	2540 endast bok only beech			2
KL72				780			
LED72.2				2010			
CL72				1040			
CL74				890			

Artno	Välj beslag: förnicklat eller mässing. *Vid skåp B400 ange vänster eller högerhängad dörr, framifrån sett. Choice of fittings: nickelplated or brass. *Cabinet W400 state when ordering right or left door, seen from the front.	Bredd Width mm	Djup Depth mm	Höjd Height mm	KA72 SEK			Extra SEK		
					.10 ek oak .20 björk birch .30 ask ash	.43 Cherry	.50 Lack Color	Standardbets på ask Standard stain on ash Vitpigment ek ask White glazed oak ash	Vikt brutto Weight gross kilos	Volym Volume
730	Bokhylla Öppen. 1 fast + 4 flyttbara trähyllor. Bookcase. 1 fixed + 4 adjustable wooden shelves.	800	330	2020	17060	21500	13640	+2570	39	0,8
732	Skåp. Trädörrar nedtill och upptill. 1 fast + 4 flyttbara trähyllor. Cabinet. Wooden doors below and above. 1 fixed + 4 adjustable wooden shelves.	800	350	2020	31290	39640	27770	+4700	60	0,8
734	Skåp. Trädörrar nedtill och öppen hylla upptill. 1 fast + 4 flyttbara trähyllor. Cabinet. Wooden door below and open shelf above. 1 fixed + 4 adjustable wooden shelves.	800	350	2020	24790	31410	21540	+3710	49	0,8
733	Skåp. Glasörrar. 1 fast + 4 flyttbara trähyllor. Cabinet. Glass doors. 1 fixed + 4 adjustable wooden shelves.	800	350	2020	28810	36690	24650	+4320	64	0,8
735	Skåp. Trädörrar nedtill och glas upptill. 1 fast + 4 flyttbara trähyllor. Cabinet. Wooden doors below and glass above. 1 fixed + 4 adjustable wooden shelves.	800	350	2020	29380	37590	26170	+4410	62	0,8
738	Skåp. Örrar och sidor med glas. 5 flyttbara glashyllor. Cabinet. Doors and sides with glass. 5 adjustable glass shelves.	800	350	2020	32790	39710	30440	+4920	65	0,8
739	Skåp. Örrar och sidor med trä nedtill och glas upptill. 1 fast + 1 flyttbara trähyllor och 3 flyttbara glashyllor Cabinet. Doors and sides with wood below and glass above. 1 fixed + 1 adjustable wooden shelves and 3 adjustable glass shelves.	800	350	2020	33580	40510	31110	+5050	59	0,8
736	Bokhylla. Öppen. 1 flyttbar trähylla Bookcase. Open. 1 adjustable shelf.	800	330	865	9850	12560	7460	+1470	20	0,4
737	Skåp. Örrar med trä. 1 flyttbar trähylla. Bookcase. Doors with wood. 1 adjustable shelf	800	350	865	17630	22500	15230	+2640	24	0,4
760	Bokhylla. Öppen. 3 flyttbara trähyllor, exkl. sockel och krönskiva. Bookcase. Open. 3 adjustable wooden shelves, excl. base and top plate.	800	330	1155	12060	15230	9610	+1810	20	0,46
762	Skåp. Trädörrar, 3 flyttbara trähyllor, exkl. sockel och krönskiva. Cabinet. Wooden doors. 3 adjustable wooden shelves, excl. base and top plate.	800	350	1155	21720	27480	18970	+3240	36	0,46
762,S73,KS13	Skåp. Trädörrar, 3 flyttbara trähyllor inkl. sockel och krönskiva Cabinet. Wooden doors. 3 adjustable wooden shelves incl. base and top plate.	800	350	1245	25360	31590	22390	+3810	46	0,46
762,BS73,KS13	Skåp. Trädörrar, 3 flyttbara trähyllor inkl. bensockel och krönskiva Cabinet. Wooden doors. 3 adjustable wooden shelves incl. high base and top plate.	800	350	1445	28290	35540	25550	+4240	50	0,57
763	Skåp. Glasörrar. 3 flyttbara trähyllor, exkl. sockel och krönskiva. Cabinet. Glass doors. 3 adjustable wooden shelves, excl. base and top plate.	800	350	1155	20770	26220	18130	+3120	46	0,46
763,S73,KS13	Skåp. Glasörrar. 3 flyttbara trähyllor inkl. sockel och krönskiva Cabinet. Glass doors. 3 adjustable wooden shelves incl. base and top plate.	800	350	1245	24180	30330	21530	+3610	46	0,46
763,BS73,KS13	Skåp. Glasörrar. 3 flyttbara trähyllor inkl. bensockel och krönskiva Cabinet. Glass doors. 3 adjustable wooden shelves incl. high base and top plate.	800	350	1445	27340	34280	24700	+4100	50	0,57
740	Bokhylla Öppen. 1 fast + 4 flyttbara trähyllor. Bookcase. 1 fixed + 4 adjustable wooden shelves.	400	330	2020	14010	17650	11480	+2100	30	0,42
741	Bokhylla. 7 lådor nedtill. 1 fast + 3 flyttbara trähyllor. Bookcase. 7 drawers below. 1 fixed + 3 adjustable wooden shelves.	400	350	2020	29700	39020	26110	+4450	37	0,42
744*	Skåp. Trädörrar nedtill och öppen hylla upptill. 1 fast + 4 flyttbara trähyllor. Cabinet. Wooden door below and open shelf above. 1 fixed + 4 adjustable wooden shelves.	400	350	2020	17820	22650	15340	+2670	41	0,42
743*	Skåp. Glasörrar. 1 fast + 4 flyttbara trähyllor. Cabinet. Glass doors. 1 fixed + 4 adjustable wooden shelves.	400	350	2020	19890	25360	17410	+2980	41	0,42
745*	Skåp. Trädörrar nedtill och glas upptill. 1 fast + 4 flyttbara trähyllor. Cabinet. Wooden doors below and glass above. 1 fixed + 4 adjustable wooden shelves.	400	350	2020	20250	26110	17570	+3040	41	0,42
748*	Skåp. Örrar och sidor med glas. 5 flyttbara glashyllor. Cabinet. Doors and sides with glass. 5 adjustable glass shelves.	400	350	2020	23180	27950	21100	+3480	41	0,42
749*	Skåp. Örrar och sidor med trä nedtill och glas upptill. 1 fast + 1 flyttbara trähyllor och 3 flyttbara glashyllor Cabinet. Doors and sides with wood below and glass above. 1 fixed + 1 adjustable wooden shelves and 3 adjustable glass shelves.	400	350	2020	23800	28670	21700	+3570	41	0,42
742	Byrå. 7 lådor nedtill. Chest of drawers. 7 drawers.	400	350	865	24130	33070	20980	+3610	22	0,17
746	Bokhylla. Öppen. 1 flyttbar trähylla Bookcase. Open. 1 adjustable shelf.	400	330	865	8400	11490	6590	+1260	14	0,17
747*	Skåp. Örrar med trä. 1 flyttbar trähylla. Bookcase. Doors with wood. 1 adjustable shelf.	400	350	865	12290	16840	10290	+1840	19	0,17

# 2K SKÅP Tony Almén Peter Gest 2000

Skåp är av trälamell med faner i ek, björk, standardfärger, standardbets på ek och vitpigmenterad ek. Benen är i mattkrommad stål inkl. justerbara ställfötter och handtagen i rostfritt mattborstat stål. Ska skåp placeras fristående med synlig trärygg måste en ryggpanel beställas. Skåp är ihopsatta vid leverans. Skåp i bredd 450mm ange vänster eller högerhängd dörr, framifrån sett. Till skåpen finns olika tillbehör enligt nedan.

The cabinets are made of blockboard finished in oak, birch veneer, standard color and standard stains on oak. The legs are made of matt chromed steel and the handles from stainless, matt brushed steel. If the intention is to place the cabinet away from a wall, it is necessary to order a back panel to cover the back of the cabinet. Cabinets are supplied ready assembled with adjustable screws in the leg to ensure they stand straight and steady. Cabinet in width 450mm enter left or right hung door, seen from the front. There are various accessories for the cabinets as below.

Artno

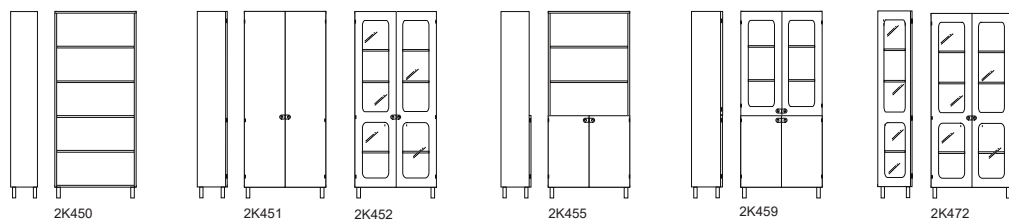
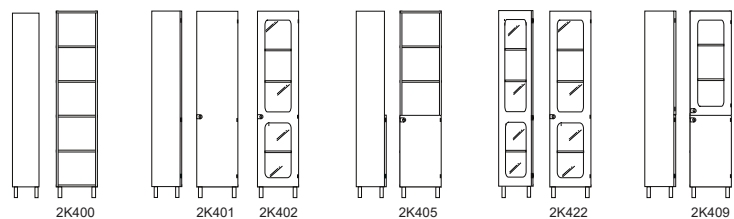
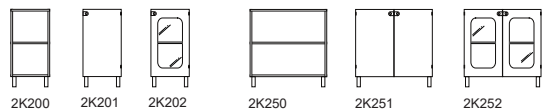
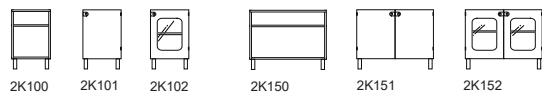

Tillbehör  
Accessories



2KC150 trä wood  
2KC100 trä wood  
2KKS1  
2KKS2  
2KKS3

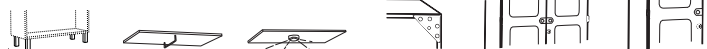

2KBS12 KL72 LED72 V CL72 CL74

2K-skåp SEK Extra SEK

Tillbehör Accessories Artno	Bredd Width mm	Djup Depth mm	Höjd Height mm	.10 ek oak .20 björk birch .50 lack color	Standardbets på ek Standard stain on oak  Vitpigment ek White glazed oak	Vikt brutto gross kilos
2KC150	860	330		1310	+200	3
2KG150	860	330		1310 glas glass		3
2KC100	410	330		950	+150	2
2KG100	410	330		950 glas glass		2
2KKS1	910	365	20	2310	+350	3 / 0,02cbm
2KKS2	1810	365	20	4620	+700	6 / 0,05cbm
2KKS3	2715	365	20	6950	+1040	9 / 0,07cbm
2KBS12.90			120	1250		3
KL72				780		
LED72.2				2010		
V				1250		
CL72.2				1040		
CL74.2				890		



Artno	*Vid skåp B450 ange vänster eller högerhängd dörr, framifrån sett. *Cabinet W450 state when ordering right or left door, seen from the front.	Bredd Width mm	Djup Depth mm	Höjd Height mm	2K-skåp SEK		Extra SEK	Vikt brutto Weight gross kilos	Volym Volume
					.10 ek oak .20 björk birch	.50 Lack Color	Standardbets på ek Standard stain on oak Vitpigment ek White glazed oak		
2K100	Bokhylla Öppen. 1 flyttbara trähylla. Bookcase. 1 adjustable wooden shelf.	450	340	696	8020	6290	+1200	18	0,15
2K101*	Skåp. Slät trädörr. 1 flyttbar trähylla. Cabinet. Plain door. 1 adjustable wooden shelf.	450	360	696	10360	9530	+1560	20	0,15
2K102*	Skåp. Glasdörr. 1 flyttbar trähylla. Cabinet. Glass door. 1 adjustable wooden shelf.	450	360	696	11500	9740	+1730	20	0,15
2K150	Bokhylla Öppen. 1 flyttbara trähylla. Bookcase. 1 adjustable wooden shelf.	900	340	696	9280	7010	+1390	22	0,32
2K151	Skåp. Släta trädörrar. 1 flyttbar trähylla. Cabinet. Plain doors. 1 adjustable wooden shelf.	900	360	696	14090	11780	+2110	30	0,32
2K152	Skåp. Glasdörrar. 1 flyttbar trähylla. Cabinet. Glass doors. 1 adjustable wooden shelf.	900	360	696	16260	13910	+2440	30	0,32
2K200	Bokhylla Öppen. 1 flyttbara trähylla. Bookcase. 1 adjustable wooden shelf.	450	340	910	8630	6760	+1300	22	0,21
2K201*	Skåp. Slät trädörr. 1 flyttbar trähylla. Cabinet. Plain door. 1 adjustable wooden shelf.	450	360	910	11230	9350	+1690	25	0,21
2K202*	Skåp. Glasdörr. 1 flyttbar trähylla. Cabinet. Glass door. 1 adjustable wooden shelf.	450	360	910	12660	10840	+1900	25	0,21
2K250	Bokhylla Öppen. 1 flyttbara trähylla. Bookcase. 1 adjustable wooden shelf.	900	340	910	9890	7490	+1480	38	0,4
2K251	Skåp. Släta trädörrar. 1 flyttbar trähylla. Cabinet. Plain doors. 1 adjustable wooden shelf.	900	360	910	15220	12760	+2290	44	0,4
2K252	Skåp. Glasdörrar. 1 flyttbar trähylla. Cabinet. Glass doors. 1 adjustable wooden shelf.	900	360	910	18130	15600	+2720	44	0,4
2K300	Bokhylla Öppen. 2 flyttbara trähyllor. Bookcase. 2 adjustable wooden shelves.	450	340	1272	10340	8190	+1550	24	0,3
2K301*	Skåp. Slät trädörr. 2 flyttbara trähyllor. Cabinet. Plain door. 2 adjustable wooden shelves.	450	360	1272	13260	11080	+1990	28	0,3
2K302*	Skåp. Glasdörr. 2 flyttbara trähyllor. Cabinet. Glass door. 2 adjustable wooden shelves.	450	360	1272	15020	12920	+2250	28	0,3
2K350	Bokhylla Öppen. 2 flyttbara trähyllor. Bookcase. 2 adjustable wooden shelves.	900	340	1272	12190	9730	+1830	50	0,54
2K351	Skåp. Slät trädörrar. 2 flyttbara trähyllor. Cabinet. Plain doors. 2 adjustable wooden shelves.	900	360	1272	18060	15550	+2700	54	0,58
2K352	Skåp. Glasdörrar. 2 flyttbara trähyllor. Cabinet. Glass door. 2 adjustable wooden shelves.	900	360	1272	21500	19060	+3220	54	0,58
2K400	Bokhylla Öppen. 1 fast + 3 flyttbara trähyllor. Bookcase. 1 fixed + 3 adjustable wooden shelves.	450	340	2062	13550	10910	+2020	30	0,5
2K401*	Skåp. Slät trädörr. 1 fast + 3 flyttbara trähyllor. Cabinet. Plain wooden door. 1 fixed + 3 adjustable wooden shelves.	450	360	2062	17330	14740	+2600	33	0,5
2K402*	Skåp. Glasdörr. 1 fast + 3 flyttbara trähyllor. Cabinet. Glass door. 1 fixed + 3 adjustable wooden shelves.	450	360	2062	20740	18130	+3120	42	0,5
2K405*	Skåp. Slät trädörr nedtill. 1 fast + 3 flyttbara trähyllor. Cabinet. Plain wooden door below. 1 fixed + 3 adjustable wooden shelves.	450	360	2062	16170	13590	+2430	31	0,5
2K409*	Skåp. Slät trädörr nedtill och glas upptill. 1 fast + 3 flyttbara trähyllor. Cabinet. Plain wooden door below and glass above. 1 fixed + 3 adjustable wooden shelves.	450	360	2062	20860	18200	+3130	42	0,5
2K422*	Skåp. Dörrar och sidor i glas. 4 flyttbara glashyllor. Cabinet. Doors and sides in glass. 4 adjustable glass shelves.	450	360	2062	26840	23860	+4040	42	0,5

Artno	*Vid skåp B400 ange vänster eller högerhängd dörr, framifrån sett. *Cabinet W400 state when ordering right or left door, seen from the front.	Bredd Width mm	Djup Depth mm	Höjd Height mm	2K-skåp SEK		Extra SEK	Vikt brutto Weight gross kilos	Volym Volume
					.10 ek oak .20 björk birch	.50 Lack Color	Standardbets på ek Standard stain on oak  Vitpigment ek White glazed oak		
2K450	Bokhylla Öppen. 1 fast + 3 flyttbara trähyllor. Bookcase Open. 1 fixed + 3 adjustable wooden shelves.	900	340	2062	16180	12660	+2430	50	0,9
2K451	Skåp. Slåta trädörrar. 1 fast + 3 flyttbara trähyllor. Cabinet. Plain wooden doors. 1 fixed + 3 adjustable wooden shelves.	900	360	2062	23860	20340	+3580	80	0,9
2K452	Skåp. Glasdörrar. 1 fast + 3 flyttbara trähyllor. Cabinet. Glass doors. 1 fixed + 3 adjustable wooden shelves.	900	360	2062	30570	27010	+4580	69	0,9
2K455	Skåp. Slåta trädörr nedtill. 1 fast + 3 flyttbara trähyllor. Cabinet. Plain wooden doors below. 1 fixed + 3 adjustable wooden shelves.	900	360	2062	21500	18050	+3220	56	0,9
2K459	Skåp. Slåt trädörr nedtill och glas upptill. 1 fast + 3 flyttbara trähyllor. Cabinet. Plain wooden door below and glass above. 1 fixed + 3 adjustable wooden shelves.	900	360	2062	30860	27340	+4620	80	0,9
2K472	Skåp. Dörrar och sidor i glas. 4 flyttbara glashyllor. Cabinet. Doors and sides in glass. 4 adjustable glass shelves.	900	360	2062	35090	31520	+5270	72	0,9

# UPPER Anton Björnsing 2019

**Skåp.** Upper har fin baksida vilket gör det lämpligt att använda som rumsavdelare. Dörrarna når ovanför själva skåpet och används som handtag. Skåp är fanerad MDF i utförande ek, ask, standardfärger, standardbetsar på ask, vitpigmenterad ek och ask. Benstativ är försedda med justerbara ställfötter. Som tillval finns låsbara hjul, lås, krönskivor i olika utförande. Skåpet levereras monterat.

**Cabinet.** Upper has an attractively finished rear panel makes the cabinet ideal as a room divider. The doors, which project above the cabinet itself, can be used as handles. The cabinet is made of veneered MDF, finished in oak, ash, standard colors, standard stains on ash or white-glazed oak or ash. Optional extras: locking wheels and top panels in white glass, cork, stainless steel, oak, ash, standard colours or standard stains. The leg frame has adjustable feet. The cabinet is delivered assembled.

Artno



UP151

UP181

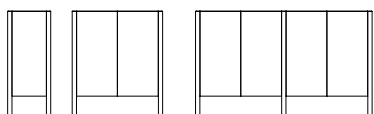

UP251

UP281

Tillbehör  
Accessories

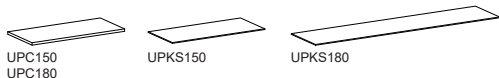

UPC150  
UPC180

UPKS150

UPKS180



UPH4  
UPH6

CL72

Artno	Bredd Width mm	Djup Depth mm	Höjd Height mm	Upper SEK		Extra SEK	Vikt netto Weight net kilos	Vikt brutto Weight gross kilos	Volym Volume	
				.10 ek oak .30 ask ash	.50 Lack Color	Standardbets på ask Standard stain on ash  Vitpigment ek, ask White glazed oak, ash				
UP151	840	400	635	16480	13170	+2470	24	32	0,28	
UP181	1640	400	635	24920	20140	+3730	42	90	1,36	
UP251	1 flyttbart hyllplan. 1 adjustable shelf.	840	400	970	19850	15770	+2980	38	46	0,41
UP281	2 flyttbara hyllplan. 2 adjustable shelves.	1640	400	970	30920	24350	+4640	70	120	1,92
<b>Tillbehör/Accessories</b>										
UPC150	Tråhyllplan till Wooden shelf to UP151, UP251	807	367	19	1130	740	+170	2	3	
UPC180	Tråhyllplan till Wooden shelf to UP181, UP281	795	367	19	1130	740	+170	3	4	
UPKS150	Krönskiva Top panel	806	366	6	1270	1270	+190	3	4	
UPKS180	Krönskiva Top panel	1606	366	6	1710	1710	+250	5	6	
UPKS150.60	Krönskiva vit laminat Top panel white laminate	806	366	6	1270			3	4	
UPKS150.90	Krönskiva rostfri. Top panel stainless steel	806	366	6	1570			3	4	
UPKS150.91	Krönskiva vitt glas. Top panel white glass	806	366	6	1570			3	4	
UPKS150.92	Krönskiva Top panel cork	806	366	6	930			1	2	
UPKS180.60	Krönskiva vit laminat Top panel white laminate	1606	366	6	1710			5	6	
UPKS180.90	Krönskiva rostfri. Top panel stainless steel	1606	366	6	2540			5	6	
UPKS180.91	Krönskiva vitt glas. Top panel white glass	1606	366	6	2540			5	6	
UPKS180.92	Krönskiva Top panel cork	1606	366	6	1230			2	3	
UPH4	Låsbara hjul, 4st. Svarta. Skåp med hjul lika höjd som skåp med ben. Lockable castors, 4pcs. Black. Cabinet incl. castors same height as cabinet.				1550					
UPH6	Låsbara hjul, 6st. Svarta. Skåp med hjul lika höjd som skåp med ben. Lockable castors, 6pcs. Black. Cabinet incl. castors same height as cabinet.				2190					
CL72	Lås förnicklat. Om lås ska sättas i båda dörrparen till UP181, UP281, glöm inte att beställa dubbelt antal lås. Lock nickelplated. If locks are to be inserted in both pair of doors artno UP181, UP281. Do not forget to order the double number of locks.				1010					

# MRS BILL Mick Born 2009

**Skåp.** Tillverkas i trälamell med faner av ek, björk, standardfärger, standardbets på ek samt vitpigmenterad ek. Ska skåpen placeras fristående med synlig rygg måste ryggpanel beställas. Skåp B450 ange vänster eller högerhängd dörr, framifrån sett. Skåpen levereras ihopsatta med ställfot i sockeln.

**Mediabänk.** Med lucka som öppnas framåt. Tillverkas i MDF med utförande standardfärger. I ryggen finns tre förborrade hål å 55mm för sladdar. Som tillval finns en låda.

**The cabinet** itself is a blockboard construction, veneered in oak, birch, standard colors, standard stains on oak or white glazed on oak. If the intention is to place the cabinet away from a wall, it is necessary to order a back panel to cover the back of the cabinet. Cabinet W450 enter left or right hung door, seen from the front. Cabinets are supplied ready assembled with adjustable screws in the plinth to ensure they stand straight and steady.

**Media bench.** With hatch that opens forward. Made of MDF with standard colors. In the back there are three pre-drilled holes of 55mm for cables. An optional box is available.

Artno

Skåp Cabinet

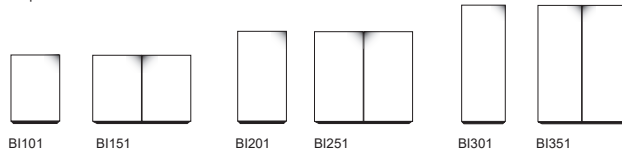

BI101 BI151 BI201 BI251 BI301 BI351

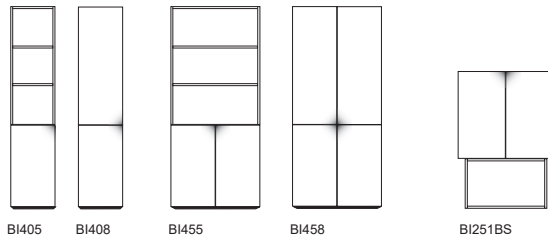

BI405 BI408 BI455 BI458 BI251BS

Mediabänk Media bench

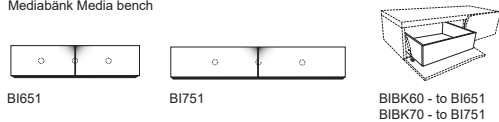

BI651 BI751 BIB60 - to BI651  
BIB70 - to BI751

Tillbehör  
Accessories

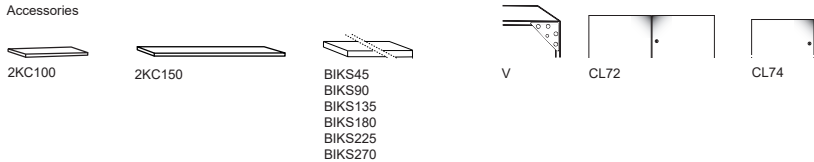

2KC100 2KC150  
BIKS45  
BIKS90  
BIKS135  
BIKS180  
BIKS225  
BIKS270  
V  
CL72  
CL74

Tillbehör Accessories Artno		Bredd Width mm	Djup Depth mm	Höjd Height mm	Mrs Bill SEK		Extra SEK	
					.10 ek oak .20 björk birch	.50 lack color	Standardbets på ek Standard stain on oak  Vitpigment ek White glazed oak	Vikt brutto Weight gross kilos
2KC150	Trähylplan till bredd 900mm Wooden shelf to width 900mm	860	330		1310	1310	+200	3
2KC100	Trähylplan till bredd 450mm Wooden shelf to width 450mm	410	330		950	950	+150	2
BIKS45	Krönskiva Top panel	450	340	40	1130	1000	+170	6
BIKS90	Krönskiva Top panel	900	340	40	2310	2050	+350	9
BIKS135	Krönskiva Top panel	1350	340	40	3490	3000	+520	12
BIKS180	Krönskiva Top panel	1800	340	40	4620	3990	+700	16
BIKS225	Krönskiva Top panel	2250	340	40	5790	5010	+870	20
BIKS270	Krönskiva Top panel	2700	340	40	6950	6030	+1040	25
BIBK60	Låda till BI651 innermått 480x380x115mm Drawer for BI651 internal 480x380x115mm				3230 björk birch			5
BIBK70	Låda till BI751 innermått 695x380x115mm Drawer for BI751 internal 695x380x115mm				3450 björk birch			5
V	Väggbeslag 4st monterade. Endast för låga skåp. Wall bracket. 4pcs mounted. Only for low cabinet.				1250			
CL72	Cylinderlås monterat i dubbeldörr. Förnicklåd Lock placed in double doors. Nickelplated				1040			
CL74	Cylinderlås monterat i enkeldörr. Förnicklåd. Lock placed in single door. Nickelplated.				890			

Artno	*Vid skåp B450 ange vänster eller högerhängd dörr, framifrån sett. *Cabinet W450 state when ordering right or left door, seen from the front.	Bredd Width mm	Djup Depth mm	Höjd Height mm	Mrs Bill SEK		Extra SEK		
					.10 ek oak .20 björk birch	.50 Lack Color	Standardbets på ek Standard stain on oak	Vikt brutto Weight gross kilos	Volym Volume
BI101*	Skåp. Slät trädörr. 1 flyttbar trähylla inkl. krönskiva BIKS45. Cabinet. Plain door. 1 adjustable wooden shelf incl. top panel BIKS45.	450	360	621	11310	9350	+1700	18	0,15
BI151	Skåp. Släta trädörrar. 1 flyttbar trähylla inkl. krönskiva BIKS90. Cabinet. Plain doors. 1 adjustable wooden shelf incl. top panel BIKS90	900	360	621	16110	13450	+2430	30	0,28
BI201*	Skåp. Slät trädörr. 1 flyttbar trähylla inkl. krönskiva BIKS45. Cabinet. Plain door. 1 adjustable wooden shelf incl. top panel BIKS45.	450	360	835	12160	10030	+1830	22	0,2
BI251	Skåp. Släta trädörrar. 1 flyttbar trähylla inkl. krönskiva BIKS90. Cabinet. Plain doors. 1 adjustable wooden shelf incl. top panel BIKS90	900	360	835	17290	14230	+2600	40	0,38
BI301*	Skåp. Slät trädörr. 2 flyttbara trähyllor inkl. krönskiva BIKS45. Cabinet. Plain door. 2 adjustable wooden shelves incl. top panel BIKS45.	450	360	1197	14420	11860	+2170	30	0,33
BI351	Skåp. Släta trädörrar. 2 flyttbara trähyllor inkl. krönskiva BIKS90. Cabinet. Plain doors. 2 adjustable wooden shelves incl. top panel BIKS90	900	360	1197	20790	17430	+3120	50	0,56
BI405*	Skåp. Slät trädörr nedtill. 1 fast + 3 flyttbara trähyllor. Skåp. Plain door below. 1 fixed + 3 adjustable wooden shelves.	450	360	1967	15700	12950	+2350	33	0,40
BI408*	Skåp. Släta trädörrar. 1 fast + 3 flyttbara trähyllor. Cabinet. Plain doors. 1 fixed + 3 adjustable wooden shelves.	450	360	1967	19160	16050	+2870	35	0,40
BI455	Skåp. Slät trädörr nedtill. 1 fast + 3 flyttbara trähyllor. Skåp. Plain door below. 1 fixed + 3 adjustable wooden shelves.	900	360	1967	21010	17190	+3160	56	0,80
BI458	Skåp. Släta trädörrar. 1 fast + 3 flyttbara trähyllor. Cabinet. Plain doors. 1 fixed + 3 adjustable wooden shelves.	900	360	1967	30190	25360	+4530	60	0,80
BI251BS	Skåp. Släta trädörrar. 1 flyttbar trähylla. Benstativ av rostfritt stål eller vitlack, inkl. krönskiva BIKS90 Cabinet. Plain doors. 1 adjustable wooden shelf. Legs of stainless steel or white lacquer incl. top panel BIKS90	900	360	1260	25960	22860	+3900	40	0,55
BI651	TV-bänk. Slät trälucka. Invändigt djup 435mm med mellansida. 1 hål i mellansidan och 3 hål i ryggen å ø55mm. TV bench. Flush wooden door. Internal depth 435mm with centre partition. One hole in the partition and 3 holes in the back, each ø55mm.	1192	480	300		13620		42	0,22
BI751	TV-bänk. Slät trälucka. Invändigt djup 435mm med mellansida. 1 hål i mellansidan och 3 hål i ryggen å ø55mm. TV bench. Flush wooden door. Internal depth 435mm with centre partition. One hole in the partition and 3 holes in the back, each ø55mm.	1620	480	300		14870		55	0,34

**Byrå.** Lådorna är gjorda i björkplywood och har delutdrag, dämpad stängning och dold expander. May tillverkas i MDF med faner av ek, ask, standardfärger, standardbetser samt vitpigmenterad ek och ask. Välj mellan massiva träben med ställfot, fyra låsbara hjul eller blankkromad stålmed. Hjulens färg är samma som stommens, men vid val av stomme i ask eller ek är hjulen alltid vita. Byrån levereras monterad.

**Chest of drawers.** The drawers are made of birch plywood and have partial extension drawer slides, dampened closure and hidden expanders. May is made of MDF and is available in oak and ash veneers, standard colors, standard stains on ash and white glazed oak or ash. Choose from solid wooden legs with adjustment screws, steel runners with a polished chrome finish or four lockable castors. The color of the castors matches the chest of drawers, except for the ash or oak versions, on which the castors are always white. May is delivered assembled.

Artno

Träfot inkl. ställfot. Solid wooden legs incl. adjustment screws.

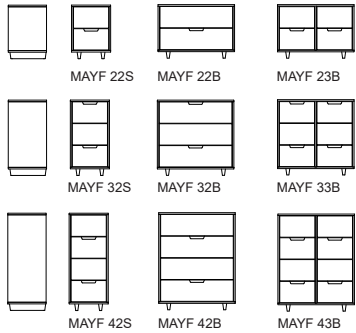

Låsbara hjul. Lockable castors.

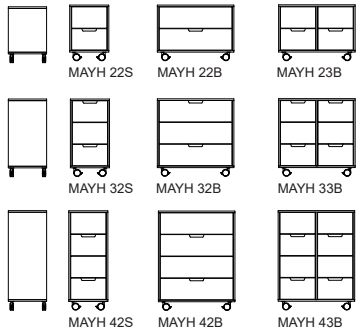

Stålmed blank krom. Steel runners polished chrome.

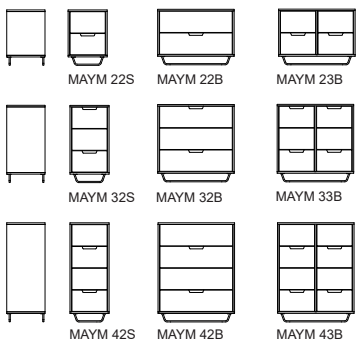

May SEK

Extra SEK

Artno	Bredd Width mm	Djup Depth mm	Höjd Height mm	May SEK		Extra SEK		Vikt brutto Weight gross kilos	Volym Volume
				.10 ek oak .30 ask ash	.50 Lack Color	Standardbets på ask Standard stain on ash	Vitpigment ek, ask White glazed oak, ask		
<b>Träfot Solid wooden legs</b>									
MAYF 22S	460	450	628	9680	6680	+1450		33	0,2
MAYF 32S	460	450	885	12240	8180	+1840		44	0,28
MAYF 42S	460	450	1141	14600	9640	+2190		52	0,34
MAYF 22B	900	450	628	10790	7730	+1620		40	0,33
MAYF 32B	900	450	885	13450	9620	+2010		66	0,5
MAYF 42B	900	450	1141	16170	11470	+2430		70	0,65
MAYF 23B	900	450	628	15270	10110	+2290		45	0,33
MAYF 33B	900	450	885	20210	13130	+3030		77	0,5
MAYF 43B	900	450	1141	25050	16140	+3750		95	0,64
<b>Låsbara hjul Lockable castors</b>									
MAYH 22S	460	450	656	9680	6680	+1450		33	0,2
MAYH 32S	460	450	912	12240	8180	+1840		44	0,28
MAYH 42S	460	450	1169	14600	9640	+2190		52	0,34
MAYH 22B	900	450	656	10790	7730	+1620		40	0,33
MAYH 32B	900	450	912	13450	9620	+2010		66	0,5
MAYH 42B	900	450	1169	16170	11470	+2430		70	0,65
MAYH 23B	900	450	656	15270	10110	+2290		45	0,33
MAYH 33B	900	450	912	20210	13130	+3030		77	0,5
MAYH 43B	900	450	1169	25050	16140	+3750		95	0,64
<b>Stålmed Steel runners</b>									
MAYM 22S	460	450	656	10480	7490	+1570		33	0,2
MAYM 32S	460	450	912	13060	8980	+1950		44	0,28
MAYM 42S	460	450	1169	15410	10450	+2310		52	0,34
MAYM 22B	900	450	656	11610	8540	+1740		40	0,33
MAYM 32B	900	450	912	14230	10420	+2130		66	0,5
MAYM 42B	900	450	1169	16980	12290	+2550		70	0,65
MAYM 23B	900	450	656	16100	10910	+2420		45	0,33
MAYM 33B	900	450	912	20990	13960	+3160		77	0,5
MAYM 43B	900	450	1169	25840	16920	+3880		95	0,64

**Mediabänk.** Luckan har ett generöst handtag med dolt spår så att den elektroniska utrustningen kan fjärrstyras utan att luckan är öppen. Ett antal hål finns förberett i rygg, topp, botten och mellansida. Hålen används för kabeldragning och möjliggör luftcirkulation. Välj mellan sockel inkl. ställfötter, hjul eller väggbeslag. Utförande MDF i standardfärger. Som tillval finns en låda i björk med fullt utdrag. Mediabänk levereras monterad.

**Media storage.** The door has a generously proportioned handle with hidden grooves so that a remote control works effectively even when the door is closed. There are holes in the back, bottom and top of the unit to allow the air to circulate and through which you can feed cables. Chose between a plinth base, castors and wall fittings. Stow is made of MDF and comes in standard colors. A fully-extension birchwood drawer is available as an accessory. Media bench is delivered assembled.

Artno

Mediabänk Media bench



STG100

STG150

STG200

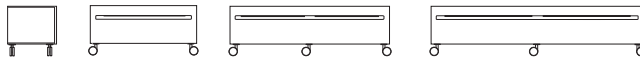

STH100

STH150

STH200

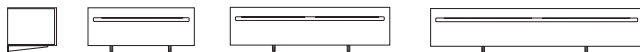

STV100

STV150

STV200

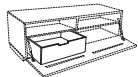

STL100  
STL150

Stow SEK

Artno		Bredd Width mm	Djup Depth mm	Höjd Height mm	.50 Lack Color	Vikt brutto Weight gross kilos	Volym Volume
<b>Mediabänk Media bench</b>							
STG100	Sockel med ställfötter. 1 flyttbart hyllplan. Base incl. adjustable feet. 1 adjustable shelf.	1000	460	400	12650	40	0,3
STG150	Sockel med ställfötter. 2 flyttbara hyllplan. Base incl. adjustable feet. 2 adjustable shelves.	1500	460	400	15560	50	0,45
STG200	Sockel med ställfötter. 2 flyttbara hyllplan. Base incl. adjustable feet. 2 adjustable shelves.	2000	460	400	17440	62	0,6
STH100	Låsbara hjul. 1 flyttbart hyllplan. Lockable castors. 1 adjustable shelf.	1000	460	460	12650	40	0,3
STH150	Låsbara hjul. 2 flyttbara hyllplan. Lockable castors. 2 adjustable shelves.	1500	460	460	15560	50	0,45
STH200	Låsbara hjul. 2 flyttbara hyllplan. Lockable castors. 2 adjustable shelves.	2000	460	460	17440	62	0,6
STV100	Vägghängd. 1 flyttbart hyllplan. Wallmouting. 1 adjustable shelf.	1000	460	355	12650	40	0,3
STV150	Vägghängd. 2 flyttbara hyllplan. Wallmouting. 2 adjustable shelves.	1500	460	355	15560	50	0,45
STV200	Vägghängd. 2 flyttbara hyllplan. Wallmouting. 2 adjustable shelves.	2000	460	355	17440	62	0,6
STL100	Låda till Mediabänk L1000 och L2000. Invändigtmått H142 B876 D333. Drawer for Media bench L1000 and L2000. Internal H142 W876 D333.				3210 björk birch	5	
STL150	Låda till Mediabänk L1500. Invändigtmått H142 B656 D333. Drawer for Media bench L1500. Internal H142 W656 D333.				3210 björk birch	5	

# CAVETTO kaschkasch 2016

Cavetto en byggbar hyllserie med oändliga variationer. Det finurliga med hyllserien är att kanterna på hyllplanen är utformade som en skåra så att man enkelt kan montera rygg och sidor mellan hyllplanen utan beslag. Cavetto kan sättas mot vägg, användas som avdelare i ett rum eller bygga ett rum i rummet. Hyllan kan användas från ett eller två håll beroende på hur man fyller hyllan med de olika tillbehören. Hyllan finns som fristående och byggsektioner.

Cavetto består av massiva runda träben med ställskruvar som sätts ihop med lamellhyllplan. Tillbehören är mellan- och yttersidor, rygg, låda med helutdrag och dörrar (endast till bredd 900mm). Backar i tre olika höjder som sätts över hyllplanen utan rygg alternativt staplas på varandra. Träslag är ek, ask, standardbetser på ask och vitpigmenterad ek eller ask. Tillbehören finns även i standardfärger. Större enheter av Cavetto levereras delmonterad och monteras ihop med enkla verktyg.

Cavetto, a shelf series that can be configured in endless variations. The ingenious thing about Cavetto is that the edges of the shelves are shaped so that back and side panels can be inserted between them without the need for any fittings. Cavetto can be placed against a wall, positioned as a room divider or used to build a room within a room. It can be accessed from one or two directions depending on how the shelves are filled with the different accessories.

Cavetto is made of round solid wood legs with adjustable feet that are linked by blockboard shelves. Cavetto can then be filled with accessories, mid sides, outer sides, backs, a fully removable drawer and pair of doors (only for width 900 mm). Crates in three different heights can be placed above the shelf or stacked on top of each other. Choose from oak, ash, standard stains on ash, white glazed oak or ash and standard colors (only for accessories). Cavetto is supplied partially assembled and can be fully assembled with simple tools

## Fristående Free standing

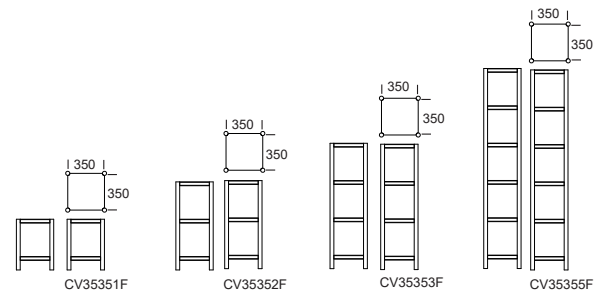
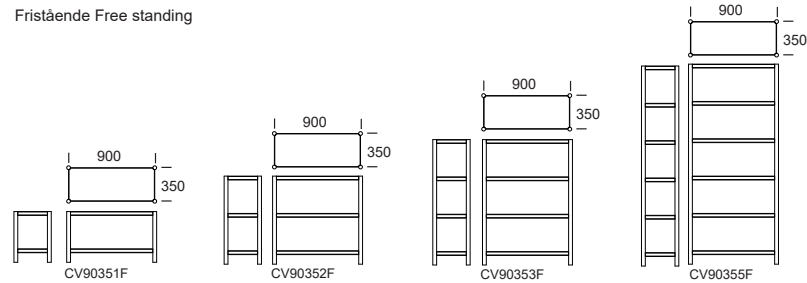

## Byggsektioner / Add-on sections

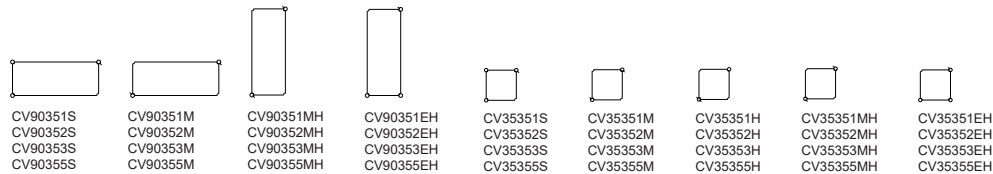

## Tillbehör Accessories

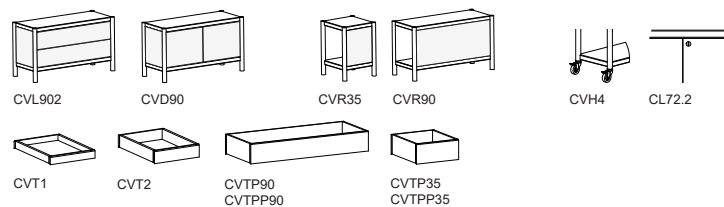

Tillbehör Accessories Artno		Cavetto SEK		Extra SEK	Vikt brutto Weight gross kilos
		.10 ek oak .30 ask ash	.50 lack color	Standardbets på ask Standard stain on ask Vitpigment ek, ask White glazed oak, ash	
CVL902	2 lådor med fullt utdrag inkl. sidor och rygg. 2 drawers incl. full extension incl. sides and back.	6580	5420	+990	17
CVD90	2 dörrar inkl. sidor och rygg. 2 doors incl. sides and back.	4600	3250	+700	10
CVR35	Rygg eller sida. Back or side	580	480	+80	1
CVR90	Rygg.Back.	860	580	+130	3
CVT1	Back. Create. Yttermått/Outside: H40 W250 D350mm Inner: H28 W226 D326mm	1280	1280	+200	0,5
CVT2	Back. Create. Yttermått/Outside: H64 W250 D350mm Inner: H52 W226 D326mm	1380	1380	+210	0,8
CVTP90	Back. Create. Yttermått/Outside: H132 W858 D350mm Inner: H120	2500	2500	+370	1,5
CVTP35	Back. Create. Yttermått/Outside: H132 W308 D350mm Inner: H120	1880	1880	+290	2
CVPP90	Insats svart plåtåda för plantering till CVTP90 Inner black metal box for flowers to CVTP90	1830			1,5
CVPP35	Insats svart plåtåda för plantering till CVTP35 Inner black metal box for flowers to CVTP35	1710			1
CVH4	Låsbara hjul. Svart. H100 ø75mm. Pris avser 4st hjul. Totalhöjd ändras med +20mm Lockable castors. Black. H100 ø75mm. Price for 4pcs. castors. Total height changed +20mm.	1550			
CL72.2	Lås förnicklad. Endast till dubbeldörr. Lock nickelplated. Only for double doors.	1040			



Artno		Bredd Width mm	Djup Depth mm	Höjd Height mm	Innermått Inner mm	Cavetto SEK		Extra SEK		Vikt brutto Weight gross kilos	Volym Volume
						.10 ek oak .30 ask ash	Standardbets på ask Standard stain on ash Vitpigment ek ask White glazed oak ash  Ben Legs	Standardbets på ask Standard stain on ash Vitpigment ek ask White glazed oak ash  Hyllplan shelves			
<b>Fristående</b> <b>Free standing</b>											
CV90351F		940	390	530		7500	+270	+430	22	0,25	
CV90352F		940	390	920		10550	+340	+650	38	0,42	
CV90353F		940	390	1310		13660	+410	+860	38	0,6	
CV90355F		940	390	2090		19690	+570	+1280	54	0,95	
CV35351F		390	390	530		6140	+270	+320	10	0,1	
CV35352F		390	390	920		8530	+340	+450	16	0,2	
CV35353F		390	390	1310		10980	+410	+600	20	0,26	
CV35355F		390	390	2090		15400	+570	+910	28	0,41	
<b>Byggsektion</b> <b>Add-on section</b>											
CV90351S	Start End section	920	390	530		7080	+270	+430	22	0,25	
CV90352S	Start End section	920	390	920		10050	+340	+650	38	0,42	
CV90353S	Start End section	920	390	1310		13050	+410	+860	38	0,6	
CV90355S	Start End section	920	390	2090		18600	+570	+1280	54	0,95	
CV90351M	Mellan Middle section	900	390	530		6670	+270	+430	22	0,25	
CV90352M	Mellan Middle section	900	390	920		9550	+340	+650	38	0,42	
CV90353M	Mellan Middle section	900	390	1310		12420	+410	+860	38	0,6	
CV90355M	Mellan Middle section	900	390	2090		17790	+570	+1280	54	0,95	
CV90351MH	Mellan efter hörnsektion Middle after corner section	900	390	530		6670	+270	+430	22	0,25	
CV90352MH	Mellan efter hörnsektion Middle after corner section	900	390	920		9550	+340	+650	38	0,42	
CV90353MH	Mellan efter hörnsektion Middle after corner section	900	390	1310		12420	+410	+860	38	0,6	
CV90355MH	Mellan efter hörnsektion Middle after corner section	900	390	2090		17790	+570	+1280	54	0,95	
CV90351EH	End efter hörnsektion End after corner section	920	390	530		7080	+270	+430	22	0,25	
CV90352EH	End efter hörnsektion End after corner section	920	390	920		10050	+340	+650	38	0,42	
CV90353EH	End efter hörnsektion End after corner section	920	390	1310		13050	+410	+860	38	0,6	
CV90355EH	End efter hörnsektion End after corner section	920	390	2090		18600	+570	+1280	54	0,95	
CV35351S	Start End section	370	390	530		5690	+270	+320	10	0,1	
CV35352S	Start End section	370	390	920		8020	+340	+450	16	0,2	
CV35353S	Start End section	370	390	1310		10350	+410	+600	20	0,26	
CV35355S	Start End section	370	390	2090		14550	+570	+910	28	0,41	
CV35351M	Mellan Middle section	350	390	530		5280	+270	+320	10	0,1	
CV35352M	Mellan Middle section	350	390	920		7530	+340	+450	16	0,2	
CV35353M	Mellan Middle section	350	390	1310		9730	+410	+600	20	0,26	
CV35355M	Mellan Middle section	350	390	2090		13710	+570	+910	28	0,41	

Artno		Bredd Width mm	Djup Depth mm	Höjd Height mm	Cavetto SEK		Vikt brutto Weight gross kilos	Volym Volume	
					.10 ek oak .30 ask ash	Extra SEK			
						Standardbets på ask Standard stain on ash Vitpigment ek ask White glazed oak ash  Ben Legs	Standardbets på ask Standard stain on ash Vitpigment ek ask White glazed oak ash  Hyllplan shelves		
<b>Byggsektion Add-on section</b>									
CV35351H	Hörn Corner section	350	390	530	5280	+270	+320	10	0,1
CV35352H	Hörn Corner section	350	390	920	7530	+340	+450	16	0,2
CV35353H	Hörn Corner section	350	390	1310	9730	+410	+600	20	0,26
CV35355H	Hörn Corner section	350	390	2090	13710	+570+	+910	28	0,41
CV35351MH	Mellan efter hörnsektion Middle after corner section	350	390	530	5280	+270	+320	10	0,1
CV35352MH	Mellan efter hörnsektion Middle after corner section	350	390	920	7530	+340	+450	16	0,2
CV35353MH	Mellan efter hörnsektion Middle after corner section	350	390	1310	9730	+410	+600	20	0,26
CV35355MH	Mellan efter hörnsektion Middle after corner section	350	390	2090	13710	+570	+910	28	0,41
CV35351EH	End efter hörnsektion End after corner section	370	390	530	5690	+270	+320	10	0,1
CV35352EH	End efter hörnsektion End after corner section	370	390	920	8020	+340	+450	16	0,2
CV35353EH	End efter hörnsektion End after corner section	370	390	1310	10350	+410	+600	20	0,26
CV35355EH	End efter hörnsektion End after corner section	370	390	2090	14550	+570	+910	28	0,41

## Förslag Suggestions



CV90352S (2pcs), CVL902 drawer, CVD door, CVT2 create (3pcs), H920 W1840 D390



CV90351S (2pcs), CVD90 door (2pcs), H530 W1840 D390



CV90353S, CV35353H, CV90353EH  
CVL902 drawer, CVD door, CVR90 back (2pcs)  
CVR35 side/back (6pcs), CVT1 create (2pcs),  
CVT2 create (1pc)  
H1310 B1290 D390



CV90353F (2pcs)  
H1310 W940 D390



CV90355S, CV95355M, CV90355S,  
CVD90 door, CVL902 drawer, CVR90 back (2pcs),  
CVR35 side/back (6pcs), CVT1 create (3pcs),  
CVT2 create (4pcs),  
H2090 W2190 D390

# SIGN Sanna Lindström 2009

Hyllan består av byggsektioner med vridbara mellansidor, sockel och toppskiva. De monteras samman med osynliga metallspindlar, vilket gör att det är enkelt att själv sätta ihop och ta isär och på så sätt anpassa Sign till nya behov. När byggsektion används som avslutning förses hålet med en synlig metallspind. Sockel är försedd med justerbara ställskruvar. Kombinationer högre än 1500 mm ska förankras i vägg med bifogade väggbeslag. Sign tillverkas i MDF och utförande standardfärger.

The shelf unit consists of a base, add-on sections and a top panel. They are assembled with invisible metal pins, making it easy to self-assemble and take apart and thus adapt Signed to new needs. When an add-on section is used as a top panel the hole fitted with a visible metal pin. The base has adjustable screws. Please note: combinations higher than 1500 mm must be fixed to the wall using the wall anchor supplied. Sign is made of MDF in standard colors.

## Artno

Byggsektioner, sockel, toppskiva  
Add-on sections, base, top panel.

↻ = vridbar / rotatable

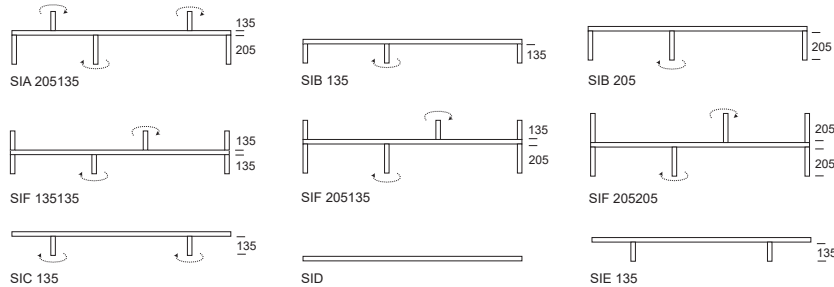

## Combinations

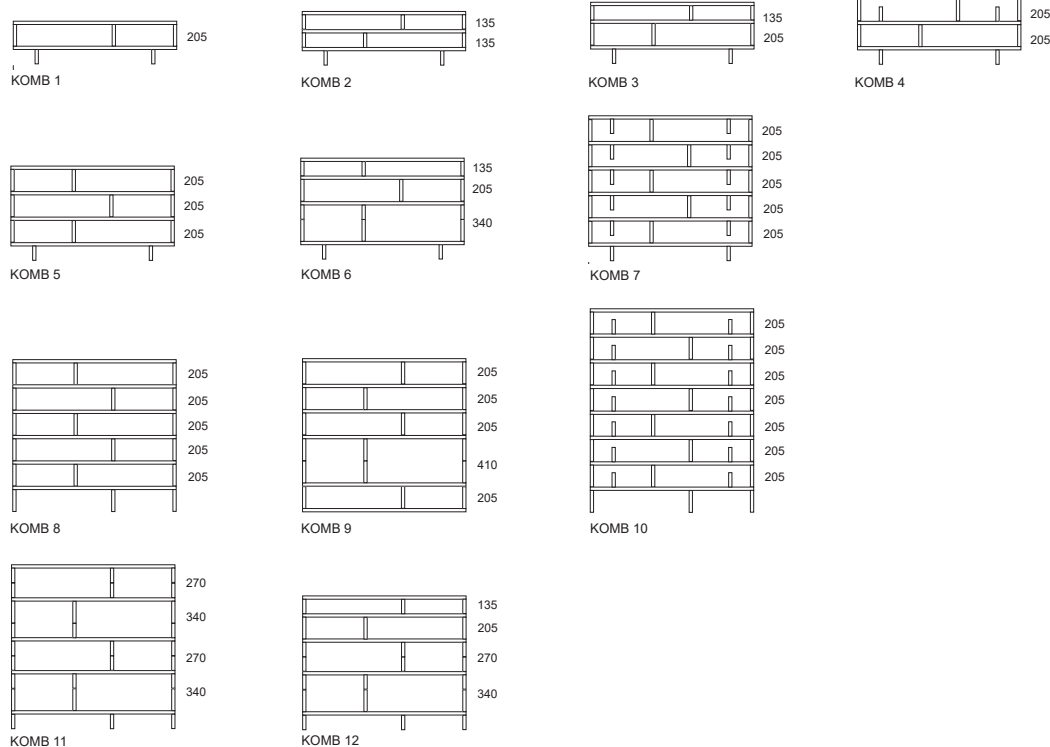

## Sign SEK

Artno		Bredd Width mm	Djup Depth mm	Höjd Height mm	.50 Lack Color	Vikt brutto Weight gross kilos	Volym Volume
SIA 205135	Sockel och byggsektion Base and add-on section	1544	330	372	4000	18	0,22
SIB 135	Sockel eller byggsektion eller toppskiva. Base or add-on section or top panel	1544	330	167	3110	18	0,11
SIB 205	Sockel eller byggsektion eller toppskiva. Base or add-on section or top panel	1544	330	237	3190	18	0,14
SIF 135135	Sockel och byggsektion Base and add-on section	1544	330	302	4410	18	0,18
SIF 205135	Sockel och byggsektion Base and add-on section	1544	330	372	4490	20	0,22
SIF 205205	Sockel och byggsektion Base and add-on section	1544	330	442	4560	22	0,25
SIC 135	Toppskiva, Top panel	1544	330	167	2720	12	0,11
SID	Toppskiva, Top panel	1544	330	32	1770	10	0,04
SIE 135	Sockel, Base	1544	330	167	2640	12	0,11
<b>Combinations</b>							
KOMB 1	1xSIA205135, 1xSID	1544	330	404	5790	40	0,25
KOMB 2	1xSIE135, 2xSIB135	1544	330	501	8850	56	0,36
KOMB 3	1xSIE135, 1xSIB205, 1xSIB135	1544	330	571	8940	56	0,36
KOMB 4	1xSIE135, 1xSIA205135, 1xSIB205	1544	330	641	9860	68	0,44
KOMB 5	1xSIE135, 3xSIB205	1544	330	878	12210	85	0,72
KOMB 6	1xSIA205135, 2xSIB135, 1xSIB205	1544	330	943	13400	90	0,68
KOMB 7	5xSIA205135, 1xSIC135	1544	330	1352	22740	140	1,11
KOMB 8	6xSIB205	1544	330	1422	19130	135	1,06
KOMB 9	6xSIB205	1544	330	1422	19130	135	1,06
KOMB 10	7xSIA205135, 1xSIB205	1544	330	1896	31230	189	1,64
KOMB 11	2xSIF205135, 2xSIF135135, 1xSIB135	1544	330	1515	20900	133	1,25
KOMB 12	1xSIF205135, 1xSIF135135, 2xSIB135, 1xSIB205	1544	330	1245	18300	120	0,92

## ALVA Rainer Mutsch 2020

Alva kombinerar skira massiva trälister som spänns med fanerad hyllplanen i MDF, till en vacker och samtidigt stark konstruktion. Designen spänner materialet till sin gräns genom vridförmågan hos träet som skapar den höga styvheten. Träslag är ek, ask, standardbets på ask och vitpigmenterad ek eller ask. Eller en kombination där trälistor kan betsas i standardbets på ask och hyllplanen i ek eller ask. I botten finns ställfötter. Hyllan levereras monterad. Hyllplanen och trälisterna är separerbara.

Alva shelving comprises slender strips of wood held securely in place by the shelves they suspend to create a construction that is as strong and stable as it is stunning to behold. The design takes the material to its limits by utilising the torsional strength of wood to create a structure of high rigidity. Alva is light and airy in appearance, but it is extremely sturdy too. The wood is oak or ash, finished with standard stains on ash, or white glaze on oak and ash. Alternatively, you can combine finishes and choose wooden frames in a standard stain on ash and shelves in oak or ash. The shelving is supplied assembled, with adjustment screws on the base. Shelves and wooden frames are detachable.

Artno

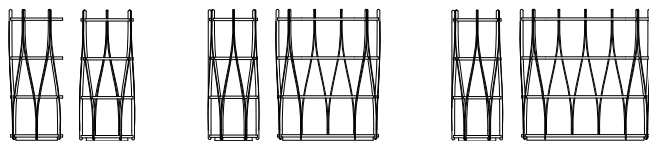

AV523

AV983

AV1233

### Alva SEK

Artno	Bredd Width mm	Djup Depth mm	Höjd Height mm	Diam mm	Alva SEK		Vikt brutto Weight gross kilos	Volym Volume
					.10 ek oak .30 ask ash	Standardbets på ask Standardstain on ash Vitpigmenterad ek, ask White glazed oak, ash		
AV523			1230	520	12560	+1940	28	0,45
AV983	980	475	1230		16980	+2550	48	0,7
AV1233	1230	475	1230		19320	+2920	60	0,87

## LEVEL Lina Nordqvist 2012

Bokhylla som består av ett antal oregelbundet placerade rundstavar som bär upp flera hyllplan i olika nivåer. Inspirationen är hämtad bland annat från byggnadsställningen samt arkitekturen och konstruktionen i ett våningshus. Varje hyllplan är individuellt höjdanpassat för exempelvis pocketböcker, inbundna böcker alternativt tidningsmagasin som kan placeras mellan rundstavarna. Utförande är standardfärger och standardbets på ask. Hyllan levereras hopsatta med ställfötter under benen.

Level is the bookshelf that consists of a number of irregularly spaced rods that support several shelves at different heights. Inspiration from builders' scaffolding and the distinctive appearance of apartment block architecture. The distance between the shelves is adapted to the different sizes of paperbacks, hardback books and magazines that can be placed between the rods. It is finished in standard colors and standard stains on ash. The bookshelf is supplied ready assembled with adjustable screws in the legs to ensure they stand straight and steady.

Artno

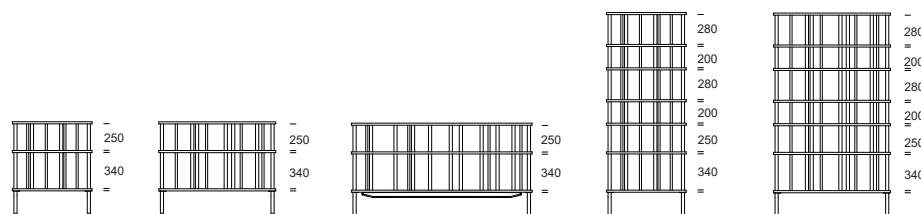

LE752

LE1102

LE1702

LE756

LE1106

### Level SEK

Artno	Bredd Width mm	Djup Depth mm	Höjd Height mm	Level SEK		Vikt brutto Weight gross kilos	Volym Volume
				.30 Standardbets på ask Standard stain on ash	.50 Lack Color		
LE752	750	320	860	8940	7820	20	0,3
LE1102	1100	320	860	10910	9560	25	0,4
LE1702	1700	320	860	15780	14120	44	0,66
LE756	750	320	1900	20180	18270	43	0,64
LE1106	1100	320	1900	25240	22510	60	0,9

## PART PetterssonRudberg 2019



Hyllan skapades under en geometrisk skisslek. Vänster- och högerhylla. Den tillverkas i massivträ i ek, ask och standardbets på ask, vitpigmenterad ek eller ask. Hyllan i standardfärg tillverkas i MDF. Hyllan skruvas upp på vägg.

Part shelf owes its origins to an exercise in geometric sketching. The shelf is available as a right- and left-hand unit. It is available in solid oak or ash, in standard stains on ash and in white-glazed oak or ash. The shelf in standard colours is made of MDF. Part is anchored to the wall with screws.

Artno



PTV212H

PTV212T  
träfront wooden ledge  
H30mm

PTV212G  
glasfront glass ledge  
H180mm

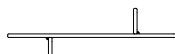

PTH212H



PTH212T  
träfront wooden ledge  
H30mm

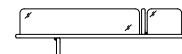

PTH212G  
glasfront glass ledge  
H180mm

### Part SEK

Artno	Bredd Width mm	Djup/Innerdjup Depth/Internal mm	Höjd Height mm	Part SEK		Extra SEK		Vikt brutto Weight gross kilos	Volym Volume
				.10 ek oak .30 ask ash	.50 Lack Color	Standardbets på ask Standard stain on ash Vitpigmenterad ek, ask White glazed oak ash			
PTV212H	1200	120	385	3550	3420	+530	6	0,08	
PTV212T	1200	120/100	385	5270	5110	+530	6	0,08	
PTV212G	1200	120/100	385	5680	5550	+530	7	0,08	
PTH212H	1200	120	385	3550	3420	+530	6	0,08	
PTH212T	1200	120/100	385	5270	5110	+530	6	0,08	
PTH212G	1200	120/100	385	5680	5550	+530	7	0,08	

# CUBE BRICK Roger Persson 2018

Hyllan hängs på vägg med upphängningsbeslag i rostfri stål. Som standard ingår ett trähyllplan men kan bytas ut mot glashyllplan som placeras nedtill. Dessutom finns en mängd tillval så som trärygg, trä- eller glashyllplan som placeras upptill, trähyllplan med dimbar LED-belysning, glassidor och glassdörrar. Träslag är massiv ask, standardbetser på ask och vitpigmenterad ask. Andra utförande efter förfrågan. Maxbelastning är 10kg per modul.

The shelf is hung on the wall with the help of the special suspension fitting in stainless steel supplied. A wooden shelf is included as standard, but customers also have the option of choosing a glass shelf. In addition there is, of course, a generous selection of accessories: wooden back, wooden or glass top panel, dimmable LED lighting, glass sides and glass doors. Cubebrick comes in solid ash, standard stains on ash and white glazed. Other options after requests. The maximum load per module is 10 kilos.

Artno



CB252

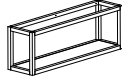

CB272



CB334

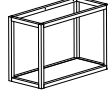

CB354

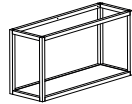

CB374

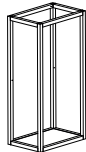

CB734

Artno		Bredd Width mm	Djup/Innerdjup Depth/Internal mm	Höjd Height mm	Cubebrick SEK		Tillbehör Accessories	Vikt brutto Weight gross kilos	Volym Volume
					.30 ask ash	Standardbets på ask Standard stain on ash Vitpigmenterad ask White glazed ash			
<b>CB252</b>	<b>Hylla inkl. trähyllplan placerad nedtill Shelf incl. wooden shelf placed below</b>	540	180/140	240	3740	+650		3	0,03
CBTH52	Trähyllplan ask Wooden shelf ash						+480		
CBH52	Glashyllplan Glas shelf						+480		
CBTHB52	LED inkl. trähyllplan ask LED incl. wooden shelf ash						+1530		
CBTR25	Trärygg ask Wooden back ash						+570		
<b>CB272</b>	<b>Hylla inkl. trähyllplan placerad nedtill Shelf incl. wooden shelf placed below</b>	720	180/140	240	3930	+700		3	0,04
CBTH72	Trähyllplan ask Wooden shelf ash						+570		
CBGH72	Glashyllplan Glas shelf						+570		
CBTHB72	LED inkl. trähyllplan ask LED incl. wooden shelf ash						+1670		
CBTR72	Trärygg ask Wooden back ash						+740		
<b>CB334</b>	<b>Hylla inkl. trähyllplan placerad nedtill Shelf incl. wooden shelf placed below</b>	360	240/200	360	3680	+640		3	0,04
CBTH34	Trähyllplan ask Wooden shelf ash						+480		
CBGH34	Glashyllplan Glas shelf						+480		
CBTHB34	LED inkl. trähyllplan ask LED incl. wooden shelf ash						+1440		
CBTR33	Trärygg ask Wooden back ash						+530		
CBGS34	Glassidor Sides of glass						+880		
CBGD33	Glasdörr enkel Door of glass single						+1300		
<b>CB354</b>	<b>Hylla inkl. trähyllplan placerad nedtill Shelf incl. wooden shelf placed below</b>	540	240/200	360	3860	+690		3	0,06
CBTH54	Trähyllplan ask Wooden shelf ash						+560		
CBGH54	Glashyllplan Glas shelf						+560		
CBTHB54	LED inkl. trähyllplan ask LED incl. wooden shelf ash						+1620		
CBTR35	Trärygg ask Wooden back ash						+610		
CBGS34	Glassidor Sides of glass						+880		
CBGD35	Glasdörr dubbel Door of glass double doors						+2690		
<b>CB374</b>	<b>Hylla inkl. trähyllplan placerad nedtill Shelf incl. wooden shelf placed below</b>	720	240/200	360	4080	+720		4	0,08
CBTH74	Trähyllplan ask Wooden shelf ash						+600		
CBGH74	Glashyllplan Glas shelf						+600		
CBTHB74	LED inkl. trähyllplan ask LED incl. wooden shelf ash						+1730		
CBTR37	Trärygg ask Wooden back ash						+740		
CBGS34	Glassidor Sides of glass						+880		
CBGD37	Glasdörr dubbel Door of glass double doors						+2980		

Artno		Bredd Width mm	Djup/Innerdjup Depth/Internal mm	Höjd Height mm	Cubebrick SEK	Extra SEK			
					.30 ask ash	Standardbets på ask Standard stain on ash Vitpigmenterad ask White glazed ash	Tillbehör Accessories	Vikt brutto Weight gross kilos	Volym Volume
<b>CB734</b>	<b>Hylla inkl. trähyllplan placerad nedtill Shelf incl. wooden shelf placed below</b>	360	240/200	720	3900	+700		4	0,08
CBTH34	Trähyllplan ask Wooden shelf ash						+480		
CBGH34	Glashyllplan Glas shelf						+480		
CBTHB34	LED inkl. trähyllplan ask LED incl. wooden shelf ash						+1440		
CBTR73	Trärygg ask Wooden back ash						+740		
CBGS74	Glassidor Sides of glass						+1140		
CBGD73	Glasdörr enkel Door of glass single						+1430		
CBGHM34	Glashyllplan placeras mitten av hylla Glass shelf placed in the middle of shelf						+1060		



3xCB734 trähyllplan nedtill wooden shelf below H360 W720 D240 invD 200 | 2xCB334 trähyllplan nedtill wooden shelf below H360 W360 D240 invD200, CBTR33 rygg | 2 x CB734 H720 W360 D240 invD200, CBTR73 rygg back, CBGS74 glassidor glass sides CBGD73 glasdörr enkel glass door single



Hylla Shelf CB374 trähyllplan nedtill wooden shelf below H360 W720 D240 invD200 | Pail Stool MILO | Pelarbord Pedestal table WOODWORK



CB374, H360 W720 D240 invD200, trähyllplan nedtill och upptill med LED. Glassidor, glasdörrar och rygg. Wooden shelf below and above incl. LED. Glass sides, doors and wooden back| CB334, H360 W360 D240 invD200, trähyllplan nedtill wooden shelf below

# TRIPPO HYLLA Ulla Christiansson 2002

Det unika med hyllan är den fasade ryggen som svävar från väggen. Trippo-hylla tillverkas i trälamell med faner i björk, ek, standardfärger och vitpigmenterad ek. Som tillbehör finns klädstång i blankkrom samt svart gummimatta som kan läggas på hyllplan för skor. Hyllan hängs på vägg med trälist.

The unique thing about the shelf is the bevelled back that floats from the wall. Trippo shelf is made of wooden slats with veneer in birch, oak, standard colors and white glazed oak. As an accessory, there is a clothes rail in glossy chrome and a black rubber mat that can be placed on shelves for shoes. The shelf is hung on the wall with a wooden strip.

Artno	W400	W800	W1200
40 138			
	TH041821 TH042321 TH043021	TH081821 TH082321 TH083021	TH121821 TH122321 TH123021
40 234			
	TH041841 TH042341 TH043041	TH081841 TH082341 TH083041	TH121841 TH122341 TH123041
40 330			
	TH041861 TH042361 TH043061	TH081861 TH082361 TH083061	TH121861 TH122361 TH123061
40 234			
	TH041842 TH042342 TH043042	TH081842 TH082342 TH083042	TH121842 TH122342 TH123042
40 330			
	TH041862 TH042362 TH043062	TH081862 TH082362 TH083062	TH121862 TH122362 TH123062
40 234			
	TH041843 TH042343 TH043043	TH081843 TH082343 TH083043	TH121843 TH122343 TH123043
40 234			
	TH041847 TH042347 TH043047		

Tillbehör Accessories	Artno		Bredd Width mm	Djup Depth mm	Pris Price SEK
	THKL04	Klädhängare exkl. hylla. Till hylla B400 D300mm. Coat hanger polished chrome excl. shelf. To shelf W400 D300mm	400	300	1730
	THKL08	Klädhängare exkl. hylla. Till hylla B800 D300mm. Coat hanger polished chrome excl. shelf. To shelf W800 D300mm	800	300	2310
	THKL12	Klädhängare exkl. hylla. Till hylla B1200 D300mm. Coat hanger polished chrome excl. shelf. To shelf W1200 D300mm	1200	300	2460
	THGU80	Gummimatta svart, exkl. hylla. Till hylla B800 D300mm. Till hylla som används som skohylla. Rubber carpet black, excl. shelf. For shelf W800 D300mm. For use as a shoe shelf.	800	300	580
	THGU120	Gummimatta svart, exkl. hylla. Till hylla B1200 D300mm. Till hylla som används som skohylla. Rubber carpet black, excl. shelf. For shelf W1200 D300mm. For use as a shoe shelf.	1200	300	820

# TRIPPO HYLLA Ulla Christiansson 2002

Artno	Bredd Width mm	Djup Depth mm	Höjd Height mm	Trippo-hylla SEK		Extra SEK		
				.10 ek oak .20 björk birch	.50 Lack Color	Vitpigmenterad ek White glazed oak	Vikt brutto Weight gross kilos	Volym Volume
TH041821	400	180	200	3990	3560	+590	4	0,04
TH042321	400	230	200	4080	3720	+610	4	0,04
TH043021	400	300	200	4200	3780	+630	4	0,04
TH041841	400	180	296	4120	3700	+610	5	0,06
TH042341	400	230	296	4230	3850	+630	5	0,06
TH043041	400	300	296	4320	3920	+650	5	0,06
TH041842	400	180	552	6290	5600	+940	9	0,08
TH042342	400	230	552	6500	5950	+980	9	0,08
TH043042	400	300	552	6660	6070	+1000	9	0,08
TH041843	400	180	808	8200	7300	+1240	13	0,15
TH042343	400	230	808	8510	7810	+1270	13	0,15
TH043043	400	300	808	8730	8060	+1310	13	0,15
TH041847	400	180	1832	16050	14330	+2420	24	0,25
TH042347	400	230	1832	16750	15520	+2500	24	0,25
TH043047	400	300	1832	17280	16070	+2600	24	0,25
TH041861	400	180	392	4250	3780	+640	6	0,07
TH042361	400	230	392	4360	3960	+650	6	0,07
TH043061	400	300	392	4440	4050	+670	6	0,07
TH041862	400	180	744	6540	5850	+980	11	0,13
TH042362	400	230	744	6770	6170	+1010	11	0,13
TH043062	400	300	744	6920	6340	+1040	11	0,13

Artno	Bredd Width mm	Djup Depth mm	Höjd Height mm	Trippo-hylla SEK		Extra SEK		
				.10 ek oak .20 björk birch	.50 Lack Color	Vitpigmenterad ek White glazed oak	Vikt brutto Weight gross kilos	Volym Volume
TH081821	800	180	200	4720	4200	+710	7	0,07
TH082321	800	230	200	4820	4290	+730	7	0,07
TH083021	800	300	200	4920	4370	+740	7	0,07
TH081841	800	180	296	5180	4610	+770	8	0,12
TH082341	800	230	296	5280	4720	+780	8	0,12
TH083041	800	300	296	5980	4820	+900	8	0,12
TH081842	800	180	552	7750	6880	+1160	18	0,18
TH082342	800	230	552	7940	7080	+1190	18	0,18
TH083042	800	300	552	8950	7280	+1350	18	0,18
TH081843	800	180	808	10410	9250	+1560	22	0,27
TH082343	800	230	808	10710	9530	+1610	22	0,27
TH083043	800	300	808	11910	9850	+1800	22	0,27
TH081861	800	180	392	5350	4740	+810	13	0,13
TH082361	800	230	392	5440	4840	+820	13	0,13
TH083061	800	300	392	6200	4930	+930	13	0,13
TH081862	800	180	744	8320	7410	+1250	22	0,24
TH082362	800	230	744	8540	7630	+1280	22	0,24
TH083062	800	300	744	9470	7810	+1430	22	0,24
TH121821	1200	180	200	5540	4920	+830	10	0,09
TH122321	1200	230	200	5680	5020	+860	10	0,09
TH123021	1200	300	200	5780	5140	+870	10	0,09
TH121841	1200	180	296	6050	5420	+900	11	0,17
TH122341	1200	230	296	6200	5530	+930	11	0,17
TH123041	1200	300	296	6340	5610	+950	11	0,17
TH121842	1200	180	552	9050	8150	+1360	20	0,26
TH122342	1200	230	552	9370	8300	+1410	20	0,26
TH123042	1200	300	552	9620	8550	+1450	20	0,26
TH121843	1200	180	808	12150	10880	+1820	30	0,40
TH122343	1200	230	808	12580	11160	+1890	30	0,40
TH123043	1200	300	808	12930	11520	+1940	30	0,40
TH121861	1200	180	392	6290	5600	+940	15	0,20
TH122361	1200	230	392	6420	5700	+960	15	0,20
TH123061	1200	300	392	6540	5850	+980	15	0,20
TH121862	1200	180	744	9620	8580	+1450	26	0,35
TH122362	1200	230	744	9910	8810	+1480	26	0,35
TH123062	1200	300	744	10140	9010	+1520	26	0,35



# CHESS Malin Lundmark 2010

Klädhängare. Vägghängd. Massiv trä.  
Coat hanger. Wall mounted. Solid wood.



CSK kung king  
CSQ drottning queen  
CSP bonde pawn

## Chess SEK

Artno	Djup Depth mm	Diam mm	.50s Svart Black .50v Vit White	Vikt Weight kilos
CSK	118	100	490	0,5
CSQ	138	100	490	0,5
CSP	105	92	490	0,5

# KNOB Patrik Hansson 2010

Klädhängare. Vägghängd.  
Coat hanger. Wall mounted.



KN1 Massiv trä. 4-pack.  
Solid wood. Set of 4pcs.  
KNDS Dörrstopp svart gummi. 4-pack.  
Door stop black rubber. Set of 4pcs.

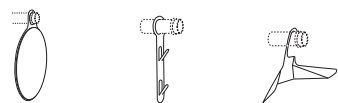

KNS Spegel metall.  
Mirror metal.  
KNH2 Krokar metall.  
Coat hook metal.  
KNG Galge metall.  
Coat hanger metal.

## Knob SEK

Artno	Djup Depth mm	Bredd Width mm	Höjd Height mm	Diam mm	s = Svart Black v = Vit White	Vikt Weight kilos
KN1.30	95			46	710	0,5
KNDS					80	
KNS1			295	240	510	0,5
KNH2			225		340	0,5
KNG1		430	140		450	0,5

# NEST Gabriella Gustafson Mattias Ståhlbom 2007

Klädhängare. Massiv trä. Coat hanger. Solid wood.

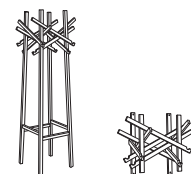

NEG1 golv / floor  
NEV1 vägg / wall

## Nest SEK

## Extra SEK

Artno	Bredd Width mm	Djup Depth mm	Höjd Height mm	.10 ek oak .20 björk birch .50 lack color	Standardbets, Vitpigment på ek Standard stain White glazed on oak	Vikt Weight kilos	Volym Volume
NEG1	500	500	1750	9170	+1370	16	0,73
NEV1	600	300	600	6290	+940	6	0,2

**Klädhängare.**  
Vägghängd. Kompaktlaminat.

**Coat rack**  
Wall model. Compact laminate.

Artno

Vägghängd Wall mounted



PO12



PO25



PO50



PO75



PO100

**ponoq SEK**

Artno	Bredd Width mm	Djup Depth mm	Höjd Height mm	UTSIDA/insida .60 VIT/svart .61 SVART/vit	OUTSIDE/inside WHITE/black BLACK/white	Vikt Weight kilos	Volym Volume
Vägghängd Wall mounted							
PO12	124	16/50	140	1090		0,5	0,001
PO25	248	16/50	140	1580		1	0,002
PO50	498	16/50	140	2260		2	0,01
PO75	744	16/50	140	3420		3	0,02
PO100	996	16/50	140	3870		4	0,03

## FRONT KLÄDHÄNGARE COAT HANGER Skala Design 2004

**Front Klädhängare.** Massiv trä. Hängare av massiv wenge. Skruvas upp i vägg. Specialmått och andra utförande efter förfrågan. Vid beställning ange artikelnummer och utförande på trälist.

**Front Coat hanger.** Solid wood. Hooks in solid wenge. Secured directly to the wall. Special sizes and other finishes upon request.. Vid beställning ange artikelnummer och utförande på trälist.

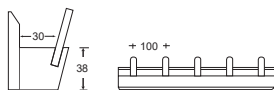

FR4 25

FR4 50

FR4 100



FR4 150



FR4 200

**Front coat hanger SEK**

**Extra SEK**

Artno	Bredd Width mm	Djup Depth mm	Höjd Height mm	.10 ek oak .20 björk birch	.50 Lack Color	Standardbets på ek Standard stain on oak Vitpigment ek White glazed oak	Vikt Weight kilos	Volym Volume
<b>Klädhängare Coat hanger</b>								
FR4 25 Tre hängare Three hangers	250	60	75	1800	2100	+170	1	0,01
FR4 50 Fem hängare Five hangers	500	60	75	2130	2500	+210	1	0,02
FR4 100 Tio hängare Ten hangers	1000	60	75	3350	3860	+340	2	0,03
FR4 150 Femton hängare Fifteen hangers	1500	60	75	4600	5270	+460	3	0,04
FR4 200 Tjugo hängare Twenty hangers	2000	60	75	5780	6670	+580	4	0,05

## ELL Lasse Pettersson 2021

### Tidskrifts- och broschyrförvaring.

Ram massivträ. Klarglas 6mm. Klarlack.Väggmonterad.

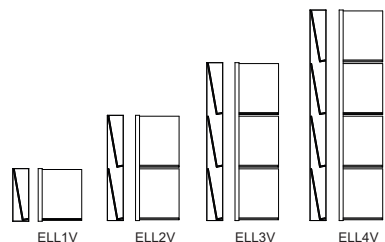

### MÖBELFAKTA

### Magazine and brochure storage.

Solid wood. Clear glass 6mm. Clear lacquer. Wall mounted.

Artno	Bredd Width mm	Djup Depth mm	Höjd Height mm	ELL SEK		Extra SEK		
				.10 ek oak .20 björk birch .30 ask ash	.50 lack color	Standardbets på ask Standard stain on ash	Vikt Weight kilos	Volym Volume
ELL1V	275	100	330	2570	2750	+380	4	0,02
ELL2V	275	100	660	4450	4730	+670	8	0,04
ELL3V	275	100	990	6540	7050	+980	10	0,05
ELL4V	275	100	1320	8420	8790	+1260	14	0,06

## COLLAR Louise Hederström 2011

### Tidskrifts- och broschyrförvaring.

Fanerad MDF. Väggmonterad.

COT11011 har fem flyttbara avdelare vilket ger fyra fack.

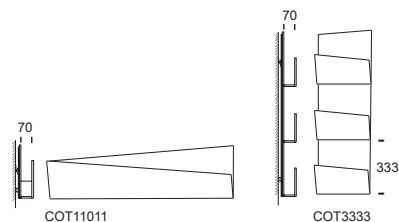

### MÖBELFAKTA

### Magazine and brochure storage.

Veneerad MDF. Wall mounted

COT11011 has five adjustable dividers, get four sections.

Artno	Bredd Width mm	Djup Depth mm	Höjd Height mm	Collar SEK		Extra SEK		
				.10 ek oak .20 björk birch .30 ask ash	.50 lack color	Standardbets på ask Standard stain on ash	Vikt Weight kilos	Volym Volume
COT11011	1128	107	316	3850	3350	+580	8	0,08
COT3333	355	107	1029	5420	4720	+820	9	0,08

## ARC Sanna Lindström 2019

### Tidskrifts- och broschyrförvaring.

Ram massivträ. Front i fanerad plywood. Rygg fanerad MDF. Väggmonterad.

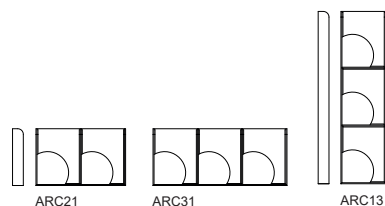

### MÖBELFAKTA

### Magazine and brochure storage.

Frame in solid wood. Front in veneered plywood. Back veneered MDF. Wall mounted.

Artno	Bredd Width mm	Djup Depth mm	Höjd Height mm	Fack Invändigt mått Partition Internal dimension W/D/H	Arc SEK		Extra SEK		
					.10 ek oak .20 björk birch .30 ask ash	.50 lack color	Standardbets på ask Standard stain on ash	Vikt Weight kilos	Volym Volume
ARC21	540	77	342	249/53/330	4200	4070	+630	6	0,03
ARC31	807	77	342	249/53/330	5010	4820	+750	7	0,04
ARC13	273	77	1038	249/53/330	5200	5040	+770	7	0,04

# SVALL Cecilia Cronelid 2016

## Tidskrifts- och Broschyrförvaring.

Svall finns som horisontell och vertikal modell.  
Massiv trä. Klarlack. Upphängning med dolda  
nyckelhålsbeslag.

## Magazine and brochure storage.

Svall is available as a horizontal and vertical model.  
Solid wood. Clear lacquer.  
Secures to the wall with concealed brackets.

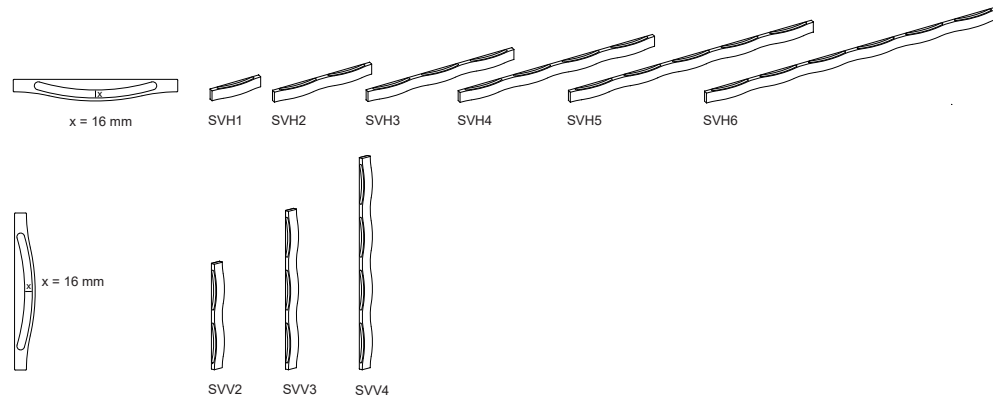

Artno	Bredd Width mm	Djup Depth mm	Höjd Height mm	Svall SEK		Vikt Weight kilos	Volym Volume
				.10 ek oak .30 ask ash .50 lack color	Standardbets på ask Standard stain on ash Vitpigment ek, ask White glazed oak, ash		
<b>Horisontell Horizontally</b>							
SVH1	330	43	70	1340	+200	1	0,01
SVH2	660	43	70	1670	+240	2	0,01
SVH3	990	43	70	2070	+320	3	0,01
SVH4	1320	43	70	2440	+370	4	0,01
SVH5	1650	43	70	3000	+450	5	0,01
SVH6	1980	43	70	3570	+530	6	0,02
<b>Vertikal Vertical</b>							
SVV2	70	43	660	1670	+240	2	0,1
SVV3	70	43	990	2070	+320	3	0,1
SVV4	70	43	1320	2440	+370	4	0,1

# 1KM DISPLAY Kristofer Jonsson Fanny Jiseborn, white 2016

## Förvaring.

1KM Display en förvaring till sovrum, kök, kontor,  
hall mm. Vägghängd i massiv trä. Klarlack.  
Skrivas upp i vägg.

## Storage.

1KM Display a storage for bedrooms, kitchen,  
office, hall etc. Wall mounted. Solid wood clear  
lacquer. Screwed up into the wall.

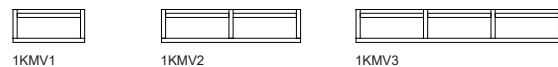
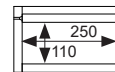

## Kopplingssektioner Connecting sections



## Tillbehör Accessories

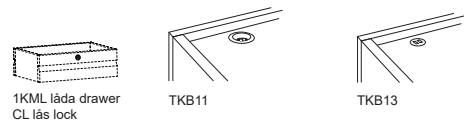

Artno	Bredd Width mm	Djup Depth mm	Höjd Height mm	1KM Display SEK		Vikt Weight kilos	Volym Volume
				.10 ek oak .30 ask ash	.50 Lack Color		
1KMV1	379	272	174	4980	3550	8	0,03
1KMV2	736	272	174	7560	5080	14	0,05
1KMV3	1093	272	174	10140	6690	18	0,09
<b>Kopplingssektioner Connecting sections</b>							
1KMV1S start	379	272	174	4980	3550	8	0,03
1KMV2S start	736	272	174	7560	5080	14	0,05
1KMV3S start	1093	272	174	10140	6690	18	0,09
1KMV3M mellan middle	1071	272	174	9410	6210	17	0,08
1KMV3E end	1093	272	174	9410	6210	17	0,08
<b>Tillbehör Accessories</b>							
1KML låda drawer. invändigt/internal D218	332	250	107	2050	2050	1,3	
CL lås förnicklat lock nickelplated				900			
TKB11 Powerdot Mini diam 57mm. 1 eluttag, 1,5m kabel. Svart. Placeras på hyllans ovansida. Gäller för SE,NO,DK,DK,FIN,DE,NL. Powerdot Mini diam 57mm. 1 electrical outlet.1,5m cable. Black. Placed on the top of the shelf. For SE,NO,DK,DK,FIN,DE,NL.				710 svart black			
TKB13 Powerdot Micro diam 35mm. 1xUSB A, 1xUSB C, 1,5m kabel. Svart. Placeras på hyllans ovansida. Gäller för SE,NO,DK,DK,FIN,DE,NL. Powerdot Micro diam 35mm, 1xUSB A, 1xUSB C. 1,5m cable. Black. Placed on the top of the shelf. For SE,NO,DK,DK,FIN,DE,NL.				1080 svart black			

# FRONT LIST LEDGE

Skala Design 2004



**Front List.** Massiv trä. Skruvas upp i vägg. Härdat klarglas som standard, vilket sätts i skåran av listen. Plexi finns mot tillägg och ska anges vid beställning. Andra träslag och färger än standard begär offert.

Vid beställning ange artikelnummer, utförande och höjd på glas.

**Speciallängd: Pris tag närmast övre längd +660 SEK.**

**Front ledge.** Solid wood. All sizes are secured directly to the wall. As standard tempered clear glass which inserted in the groove of the ledge. Plexi as extra cost and need to be state when ordering Other wood or colors upon request.

State when ordering: article number, finish and height of glass.

**Special lengths: Take price of next length +660 SEK**

Artno

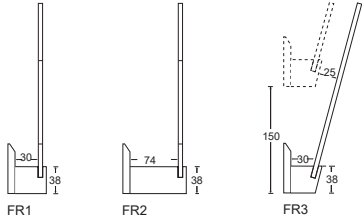

FR1

FR2

FR3

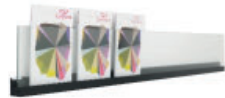

FR1 = D54



FR2 = D98



FR3

Tillbehör Accessories



FRAV 1

FRAV 2

Avdelare Divider Avdelare Divider to FR1, FR3

Front List SEK			Extra SEK			
----------------	--	--	-----------	--	--	--

Artno	Bredd Width mm	Djup Depth mm	Höjd Height mm	Klarglas höjd Clear glass height mm	Front List SEK		Extra SEK					
					.10 ek oak .20 björk birch	.50 Lack Color	Standardbets på ek Standard stain on oak	Plexi glas FRP	Gelelim till glas 3gr/tube FRLIM	Vikt Weight kilos	Volym Volume	
<b>Rak list Straight ledge D54</b>												
FR1 25	250	54	70	32/150/230	1450	1670	+150	+230	+140	1/1/2	0,01	
FR1 50	500	54	70	32/150/230	1770	2070	+170	+330	+140	1/2/3	0,01	
FR1 100	1000	54	70	32/150/230	2580	2960	+250	+460	+140	2/4/6	0,01/0,01/0,02	
FR1 150	1500	54	70	32/150/230	3370	3880	+340	+650	+140	3/6/9	0,01/0,01/0,02	
FR1 200	2000	54	70	32/150/230	4340	5010	+430	+810	+140	4/9/11	0,01/0,02/0,03	
<b>Rak list Straight ledge D98</b>												
FR2 25	250	98	70	32/150/230	1700	2010	+170	+230	+140	2/2/3	0,01/0,01/0,02	
FR2 50	500	98	70	32/150/230	2060	2350	+210	+330	+140	2/3/4	0,01/0,01/0,02	
FR2 100	1000	98	70	32/150/230	3100	3550	+320	+460	+140	3/5/7	0,01/0,01/0,03	
FR2 150	1500	98	70	32/150/230	4120	4740	+400	+650	+140	4/7/10	0,01/0,02/0,04	
FR2 200	2000	98	70	32/150/230	5290	6070	+530	+810	+140	5/10/12	0,02/0,03/0,05	
<b>Snedställd list Sloping ledge</b>												
FR3 25	250	54/105	70	150/230	1450	1670	+150	+230	+140	1/2	0,01	
FR3 50	500	54/105	70	150/230	1770	2070	+170	+330	+140	2/3	0,01	
FR3 100	1000	54/105	70	150/230	2580	2960	+250	+460	+140	4/6	0,01/0,02	
FR3 150	1500	54/105	70	150/230	3370	3880	+340	+650	+140	6/9	0,01/0,02	
FR3 200	2000	54/105	70	150/230	4340	5010	+430	+810	+140	9/11	0,02/0,03	
<b>Tillbehör Accessories Avdelare Divider</b>												
FRAV1	12	44	38		140	140	+10					
FRAV2	12	88	38		150	150	+10					

# FRONT HYLLA SHELF Skala Design 2012

Front Hylla. Massiv trä. Skruvas upp i vägg.  
Samtliga hyllor skruvas rakt in i vägg, djup 250 mm förstärks även med dold konsol. Andra träslag och färger än standard begär offert.

Vid beställning ange artikelnummer och utförande.

**Speciallängd: Pris tag närmast övre längd +660 SEK.**

Front shelf. Solid wood. All sizes are secured directly to the wall. The 250 mm deep shelf is reinforced with a hidden bracket. Other wood or colors upon request.

State when ordering: article number and finish.

**Special lengths: Take price of next length +660 SEK**

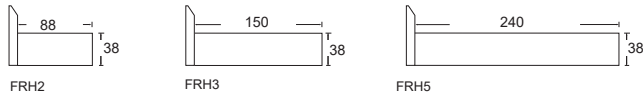

Artno	Maxvikt per hylla Max load per shelf kilos	Bredd Width mm	Djup Depth mm	Höjd Height mm	Front Hylla SEK		Extra SEK		Vikt Weight kilos	Volym Volume
					.10 ek oak .20 björk birch	.50 Lack Color	Standardbets på ek Standard stain on oak	Vitpigment ek White glazed oak		
<b>Hylla Shelf D98</b>										
FRH2 25	8	250	98/88	70	1550	1750	+150		2	0,01
FRH2 50	10	500	98/88	70	1940	2190	+200		2	0,01
FRH2 100	15	1000	98/88	70	2930	3350	+300		3	0,01
FRH2 150	20	1500	98/88	70	3860	4420	+380		4	0,01
FRH2 200	25	200	98/88	70	5110	5900	+510		5	0,02
<b>Hylla Shelf D160</b>										
FRH3 25	8	250	160/150	70	2050	2350	+200		2	0,01
FRH3 50	10	500	160/150	70	2580	2980	+250		3	0,01
FRH3 100	15	1000	160/150	70	3700	4240	+370		6	0,01
FRH3 150	20	1500	160/150	70	4660	5360	+480		9	0,02
FRH3 200	25	2000	160/150	70	6030	6920	+600		12	0,03
<b>Hylla Shelf D250</b>										
FRH5 25	10	250	250/240	70	2570	2960	+250		3	0,01
FRH5 50	20	500	250/240	70	3240	3730	+330		5	0,01
FRH5 100	30	1000	250/240	70	4580	5270	+460		8	0,02
FRH5 150	40	1500	250/240	70	6010	6910	+600		10	0,03
FRH5 200	50	2000	250/240	70	7540	8660	+750		15	0,04

# FRONT PLANT Skala Design 2009

Front Plant. En kombination av list och glaslåda (L500mm) för exempelvis växter. List massiv trä. Skruvas upp i vägg. Glaslåda sätts i skåran av listen.

Andra träslag och färger än standard begär offert.

Vid beställning ange artikelnummer, utförande på list och glaslåda.

Front Plant. A combination of a wood ledge and glass box (L500mm) for plants. Ledge in solid wood. Secured directly to the wall. Glass box is inserted in the groove of the ledge. Other wood or colors upon request.

State when ordering: article number and finish of ledge and glass box.

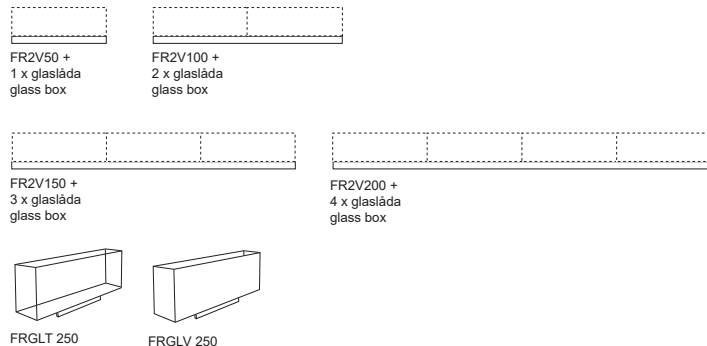

Artno	Bredd Width mm	Djup Depth mm	Höjd Height mm	Front Plant SEK		Extra SEK		Vikt Weight kilos	Volym Volume
				.10 ek oak .20 björk birch	.50 Lack Color	Standardbets på ek Standard stain on oak	Vitpigment ek White glazed oak		
<b>Vägglist Wall ledge</b>									
FR2V 50	500	98	38/70	2000	2250	+200		2	0,01
FR2V 100	1000	98	38/70	3000	3450	+300		4	0,01
FR2V 150	1500	98	38/70	4000	4620	+390		6	0,01
FR2V 200	2000	98	38/70	5220	5970	+520		9	0,02
<b>Glaslåda Glass box</b>									
FRGLT 250 Transparent	500	88	150	2110 transparent				5	
FRGLV 250 Vit White	500	88	150	2450 vit white				5	

# FRONT TAVLA BOARD Skala Design 2007

Front tavla, används som skylt eller där du snabbt kan byta papper för olika meddelande, fotografier eller vill exponera en affisch. List och glas har tunnare dimensioner än övriga Front. Front tavla består av liggande och stående A4 och A3 som skruvas direkt på vägg. Alternativt är ett antal liggande och stående A4 som är monterat på en träpanel. På ryggen finns ett grepp som gör det enkelt att snabbt byta papper. Affisch tavla för affischstorlek 700x500 respektive 1000x700mm. Panel och affischtavla hängs på vägg med metallist. List i massivt trä och rygg i MDF av faner. Ytbehandling klarlack. Härdat klarglas som standard. Mot tillägg finns plexiglas. Specialmått och andra utförande efter förfrågan.

Front board is a wall-mounted board for use as the backing for a sign or for displaying messages and changing them quickly and easily. Front display boards are available in A4 and A3 portrait and landscape formats, secured directly to the wall. The ledge and glass are slightly thinner than in the rest of the Front range. Alternatively, a number of landscape and portrait A4 which is mounted on a wood panel.

On the back there is a handle which makes it easy to change document. Billboard for poster-size 700x500 or 1000x700mm. Panel and billboard is mounted on the wall with a metal suspension strip. Ledge in solid wood and back in MDF. Finish clear lacquer. Tempered clear glass as standard and plexi glass upon request. Special sizes and other finishes upon request.

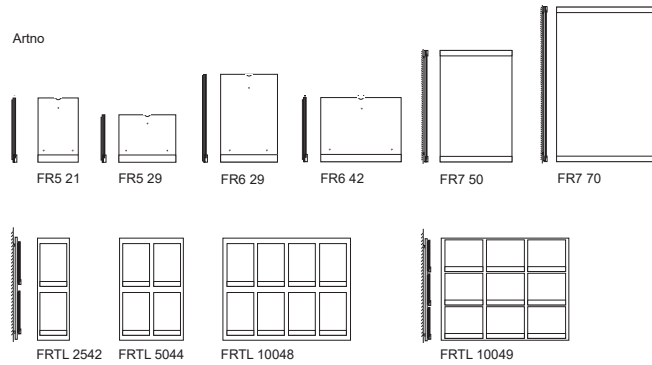

Front Tavla Board SEK Extra SEK

Artno	Bredd Width mm	Djup Depth mm	Höjd Height mm	Inv D Internal	.10 ek oak .20 björk birch .50 lack color	Standardbets på ek Standard stain on oak  Vitpigment ek White glazed oak	Plexi glas FRP	Vikt Weight kilos	Volym Volume
FR5 21	210	27	335	2	1120	+120	+230	2	0,002
FR5 29	297	27	248	2	1120	+120	+230	2	0,003
FR6 29	297	27	458	2	1450	+150	+320	4	0,005
FR6 42	420	27	335	2	1450	+150	+320	4	0,005
<b>Affisch Poster</b>									
FR7 50	500	38	776	2	2660	+270	+430	9	0,03
FR7 70	700	38	1076	2	4250	+410	+650	17	0,08
<b>Panel</b>									
FRTL 2542	250	55	800	2	4610	+460	+480	7	0,03
FRTL 5044	500	55	800	2	7460	+740	+940	13	0,05
FRTL 10048	1000	55	800	2	12920	+1300	+1880	26	0,12
FRTL 10049	1000	55	800	2	14050	+1410	+2110	28	0,12

# FRONT MONTERSKÅP DISPLAY CABINET Skala Design 2011

Utgående produkt med reservation för slutförsäljning. Front Monter-skåp är med skjutförrar i härdat glas, två flyttbara glashyllplan inkl. LED belysning. Rygg och sidor är i fanerad MDF. Som tillbehör förnicklad lås och extra glashyllplan. Upphängning sker på en metallist. Specialmått och andra utförande efter förfrågan.

Outbound product with reservation for end of stock. Front Display cabinet incl. sliding doors in tempered glass, two adjustable glass shelves and led lighting. The back and sides are in veneered MDF. As an accessory, nickel-plated lock and extra glass shelf. Suspension takes place on a metal strip. Special dimensions and other designs on request.

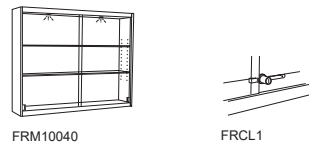

Front Display Cabinet SEK Extra SEK

Artno	Bredd Width mm	Djup Depth mm	Höjd Height mm	Inv mått Internal W/D/H	.10 ek oak .20 björk birch .50 lack color	Standardbets på ek Standard stain on oak  Vitpigment ek White glazed oak	Vikt Weight kilos	Volym Volume
FRM10040	1000	200	800	960/160/715	11480	+1720	33	0,25
<b>Tillbehör Accessories</b>								
FRCL1 Lås Förmicklad Lock Nickelplated					340 Förmicklad Nickelplated			
Extra Glashyllplan Extra Glass shelf					640 Glass Glass			

# FRONT PANEL Skala Design 2007



Front panel används som tidskrifts-, broschyrställ, spegel, anslagstavla, skrivtavla eller en kombination av dessa. Beklädnad av rygg finns att välja mellan raka eller vinklade lister, magnetisk whiteboard inklusive ett antal magneter, Bulletin Board 2204, klädd i tyg Europost från Gabriel och spegel. Specialmått och andra utförande efter förfrågan.

Panelen hängs på vägg med metallist. Listerna i massivt trä och rygg i MDF av faner. Ytbehandling klarlack. Hårdat klarglas i höjderna 32, 150 (=A5) or 230 (=A4) mm. Som tillägg finns plexiglas. Istället för glas till magnetisk whiteboard eller anslagstavla kan man välja 15 mm hög träavslut. Tillbehör: Avdelare i massiv trä som sätts på glaset för indelning i fack. Extra magneter till whiteboard.

**Rygg**  
 FRB = Bulletin Board col 2204 (kantlist endast i vit, svart, ek, björk)  
 FRK = Klädd i tyg Europost  
 FRW = Magnetic Whiteboard (kantlist endast i vit, svart , ek eller björk)  
 FRS = Spegel

Front panel is a magazine rack, a brochure stand, a mirror, a writing and noticeboard – or a combination of all these functions. You can choose the back of straight or sloping ledge, magnetic whiteboard included some magnets, Bulletin Board 2204, covered in any color of fabric Europost from Gabriel and mirror. Special sizes and ther finishes upon request.

It is secured to the wall using a metal rail. The ledges in solid wood and back in MDF of veneer. Finish clear lacquer. Tempered clear glass in height 32, 150 (=A5) or 230 (=A4) mm as standard and plexiglass upon request. Instead of glass for magnetic whiteboard and notice board you can choose of 15 mm wood end. Accessories: Dividers in solid wood that slot on top of the glass fronts to divide each shelf into compartments.

**Back**  
 FRB = Bulletin Board col 2204 (edge only in white, black, oak or birch)  
 FRK = Covered in fabric Europost  
 FRW = Magnetic Whiteboard (edge only in white, black, oak or birch)  
 FRS = Mirror

## Front panel utan list.

FRB = Bulletin Board col 2204 (kantlist endast i vit, svart, ek, björk)  
 FRK = Klädd i tyg Europost  
 FRW = Magnetic Whiteboard (kantlist endast i vit, svart, ek, björk)  
 FRS = Spegel

## Front panel excl. ledge.

**Back**  
 FRB = Bulletin Board col 2204 (edge only in white, black, oak, birch)  
 FRK = Covered in fabric Europost  
 FRW = Magnetic Whiteboard (edge only in white, black, oak, birch)  
 FRS = Mirror

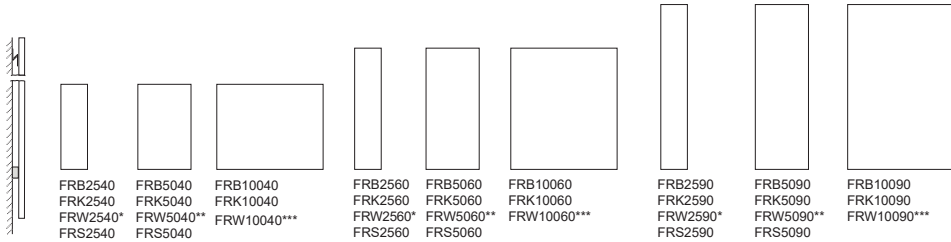

\*incl. 3 magnets  
 \*\*incl. 4 magnets  
 \*\*\*incl. 6 magnets

## Tillbehör Accessories



FRM  
 Magnet ø11

		Panel SEK	Extra SEK
--	--	-----------	-----------

Artno	Bredd Width mm	Djup Depth mm	Höjd Height mm	.10 ek oak .20 björk birch .50 lack color	Standardbets på ek Standard stain on oak Vitpigment ek White glazed oak	Vikt Weight kilos	Volym Volume
FRB2540	250	30	800	2670	+270	4	0,03
FRK2540	250	30	800	4290	+430	4	0,03
FRW2540	250	30	800	3120	+320	4	0,03
FRS2540	250	30	800	2770	+270	4	0,03
FRB5040	500	30	800	3330	+340	7	0,05
FRK5040	500	30	800	5090	+510	7	0,05
FRW5040	500	30	800	4200	+410	7	0,05
FRS5040	500	30	800	3670	+370	7	0,05
FRB10040	1000	30	800	4440	+450	14	0,1
FRK10040	1000	30	800	6010	+600	14	0,1
FRW10040	1000	30	800	6040	+600	14	0,1
FRB2560	250	30	1140	3110	+320	6	0,04
FRK2560	250	30	1140	4640	+480	6	0,04
FRW2560	250	30	1140	3630	+360	6	0,04
FRS2560	250	30	1140	3300	+340	6	0,04
FRB5060	500	30	1140	4050	+400	13	0,07
FRK5060	500	30	1140	5530	+560	13	0,07
FRW5060	500	30	1140	5100	+510	13	0,07
FRS5060	500	30	1140	4280	+430	13	0,07
FRB10060	1000	30	1140	5630	+560	20	0,15
FRK10060	1000	30	1140	7240	+730	20	0,15
FRW10060	1000	30	1140	7380	+740	20	0,15
FRB2590	250	30	1550	3550	+360	11	0,06
FRK2590	250	30	1550	5690	+570	11	0,06
FRW2590	250	30	1550	4370	+430	11	0,06
FRS2590	250	30	1550	3720	+370	11	0,06
FRB5090	500	30	1550	4710	+480	18	0,1
FRK5090	500	30	1550	6790	+690	18	0,1
FRW5090	500	30	1550	6170	+610	18	0,1
FRS5090	500	30	1550	5020	+510	18	0,1
FRB10090	1000	30	1550	6680	+670	25	0,11
FRK10090	1000	30	1550	8400	+850	25	0,11
FRW10090	1000	30	1550	8970	+900	25	0,11
Tillbehör Accessories							
FRM magnet			10	80			



# FRONT PANEL Skala Design 2007



Front panel med en rak list.  
Mer information se sid 32.

Front panel incl. one straight ledge.  
More information see page 32.

Rygg  
FRB = Bulletin Board col 2204 (kantlist endast i vit, svart, ek, björk)  
FRK = Klädd i tyg Europost  
FRW = Magnetic Whiteboard (kantlist endast i vit, svart, ek, björk)  
FRS = Spegel

Back  
FRB = Bulletin Board col 2204 (edge only in white, black, oak, birch)  
FRK = Covered in fabric Europost  
FRW = Magnetic Whiteboard (edge only in white, black, oak, birch)  
FRS = Mirror

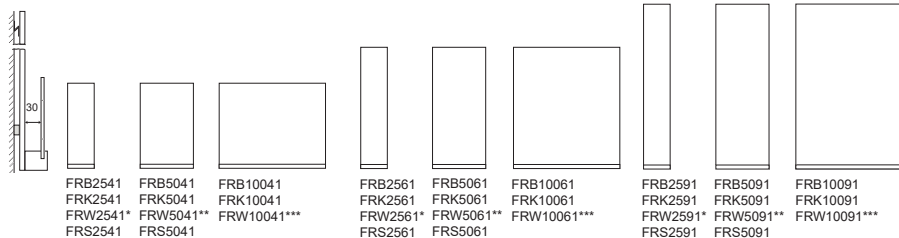

\*incl. 3 magnets  
\*\*incl. 4 magnets  
\*\*\*incl. 6 magnets

## Tillbehör Accessories



FRAV 1



FRM  
Magnet ø11

Artno	Bredd Width mm	Djup Depth mm	Höjd Height mm	Glashöjd Glass height mm	Träavslut Wood end mm	Panel SEK		Plexi FRP	Vikt Weight kilos	Volym Volume
						.10 ek oak .20 björk birch .50 lack color	Standardbets på ek Standard stain on oak Vitpigment ek White glazed oak			
FRB2541	250	70	800	32/150/230	15	3500	+350	+230	5	0,03
FRK2541	250	70	800	32/150/230	15	5090	+510	+230	5	0,03
FRW2541	250	70	800	32/150/230	15	3940	+390	+230	5	0,03
FRS2541	250	70	800	32/150/230	15	3570	+360	+230	5	0,03
FRB5041	500	70	800	32/150/230	15	4440	+450	+330	12	0,05
FRK5041	500	70	800	32/150/230	15	6210	+610	+330	12	0,05
FRW5041	500	70	800	32/150/230	15	5320	+530	+330	12	0,05
FRS5041	500	70	800	32/150/230	15	4780	+490	+330	12	0,05
FRB10041	1000	70	800	32/150/230	15	6140	+610	+460	14	0,11
FRK10041	1000	70	800	32/150/230	15	7790	+770	+460	14	0,11
FRW10041	1000	70	800	32/150/230	15	7710	+760	+460	14	0,11
FRB2561	250	70	1140	32/150/230	15	3920	+390	+230	7	0,04
FRK2561	250	70	1140	32/150/230	15	5450	+540	+230	7	0,04
FRW2561	250	70	1140	32/150/230	15	4430	+450	+230	7	0,04
FRS2561	250	70	1140	32/150/230	15	4100	+400	+230	7	0,04
FRB5061	500	70	1140	32/150/230	15	5200	+520	+330	16	0,07
FRK5061	500	70	1140	32/150/230	15	6660	+670	+330	16	0,07
FRW5061	500	70	1140	32/150/230	15	6250	+630	+330	16	0,07
FRS5061	500	70	1140	32/150/230	15	5450	+540	+330	16	0,07
FRB10061	1000	70	1140	32/150/230	15	7310	+730	+460	25	0,15
FRK10061	1000	70	1140	32/150/230	15	8910	+890	+460	25	0,15
FRW10061	1000	70	1140	32/150/230	15	9030	+900	+460	25	0,15
FRB2591	250	70	1550	32/150/230	15	4370	+430	+230	8	0,06
FRK2591	250	70	1550	32/150/230	15	6510	+650	+230	8	0,06
FRW2591	250	70	1550	32/150/230	15	5200	+520	+230	8	0,06
FRS2591	250	70	1550	32/150/230	15	4550	+460	+230	8	0,06
FRB5091	500	70	1550	32/150/230	15	5840	+580	+330	17	0,1
FRK5091	500	70	1550	32/150/230	15	7910	+780	+330	17	0,1
FRW5091	500	70	1550	32/150/230	15	7280	+730	+330	17	0,1
FRS5091	500	70	1550	32/150/230	15	6180	+610	+330	17	0,1
FRB10091	1000	70	1550	32/150/230	15	8320	+830	+460	34	0,2
FRK10091	1000	70	1550	32/150/230	15	10060	+1000	+460	34	0,2
FRW10091	1000	70	1550	32/150/230	15	10640	+1070	+460	34	0,2
<b>Tillbehör Accessories</b>										
FRAV1	12	44	38			140	+10			
FRM			10			80				

# FRONT PANEL Skala Design 2007



**Front panel med raka lister.**  
Mer information se sid 32.

**Front panel incl. straight ledges.**  
More information see page 32.

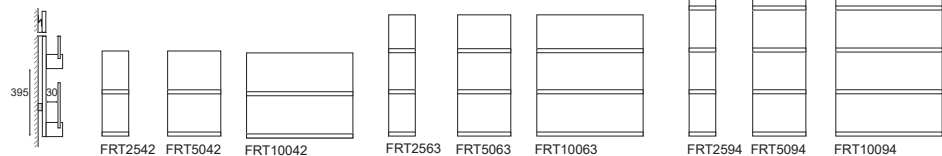

**Front panel med vinklade lister.**  
Mer information se sid 32.

**Front panel incl. sloping ledges.**  
More information see page 32.

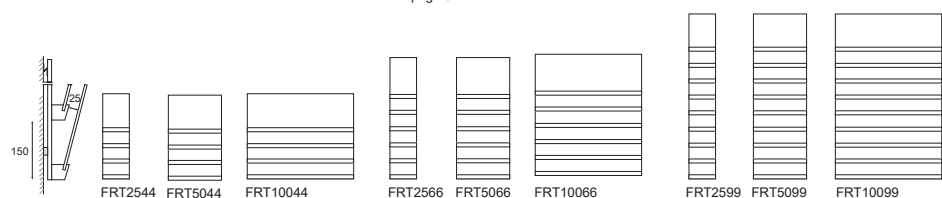

**Front panel med vinklade lister.**  
Mer information se sid 32.

**Front panel incl. sloping ledges.**  
More information see page 32.

Rygg  
FRB = Bulletin Board col 2204 (kantlist endast i vit, svart, ek, björk)  
FRK = Klädd i tyg Europost  
FRW = Magnetic Whiteboard (kantlist endast i vit, svart, ek, björk)

Back  
FRB = Bulletin Board col 2204 (edge only in white, black, oak, birch)  
FRK = Covered in fabric Europost  
FRW = Magnetic Whiteboard (edge only in white, black, oak, birch)

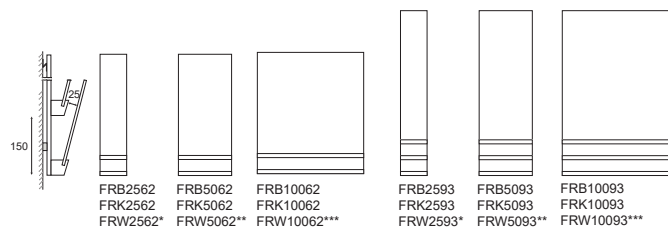

\*incl. 3 magnets  
\*\*incl. 4 magnets  
\*\*\*incl. 6 magnets

Tillbehör Accessories

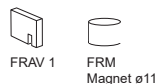

Artno	Bredd Width mm	Djup Depth mm	Höjd Height mm	Glashöjd Glass height mm	.10 ek oak .20 björk birch .50 lack color	Standardbets på ek Vitpigment ek White glazed oak	Plexi FRP	Vikt Weight kilos	Volym Volume
FRT2542	250	70	800	230	3940	+390	+480	6	0,03
FRT5042	500	70	800	230	5230	+520	+640	11	0,05
FRT10042	1000	70	800	230	7190	+720	+910	22	0,1
FRT2563	250	70	1140	230	5180	+520	+710	9	0,04
FRT5063	500	70	1140	230	6850	+690	+960	19	0,07
FRT10063	1000	70	1140	230	9530	+950	+1360	33	0,15
FRT2594	250	70	1550	230	6400	+640	+940	11	0,06
FRT5094	500	70	1550	230	8500	+860	+1280	23	0,1
FRT10094	1000	70	1550	230	11840	+1190	+1830	25	0,15
FRT2544	250	115	800	230	5760	+570	+940	10	0,03
FRT5044	500	115	800	230	7660	+760	+1280	17	0,05
FRT10044	1000	115	800	230	10670	+1070	+1830	34	0,1
FRT2566	250	115	1140	230	7890	+780	+1410	12	0,04
FRT5066	500	115	1140	230	10520	+1060	+1930	24	0,07
FRT10066	1000	115	1140	230	14800	+1480	+2750	50	0,15
FRT2599	250	115	1550	230	10840	+1090	+2110	18	0,06
FRT5099	500	115	1550	230	14580	+1460	+2880	33	0,13
FRT10099	1000	115	1550	230	20630	+2190	+4110	66	0,2
FRB2562	250	115	1140	150/230	4790	+490	+480	8	0,04
FRK2562	250	115	1140	150/230	6390	+640	+480	8	0,04
FRW2562	250	115	1140	150/230	5290	+530	+480	8	0,04
FRB5062	500	115	1140	150/230	6350	+630	+640	17	0,07
FRK5062	500	115	1140	150/230	7890	+780	+640	17	0,07
FRW5062	500	115	1140	150/230	7440	+740	+640	17	0,07
FRB10062	1000	115	1140	150/230	9030	+900	+910	35	0,15
FRK10062	1000	115	1140	150/230	10650	+1070	+910	35	0,15
FRW10062	1000	115	1140	150/230	10760	+1080	+910	35	0,15
FRB2593	250	115	1550	150/230	6110	+600	+710	10	0,06
FRK2593	250	115	1550	150/230	8250	+830	+710	10	0,06
FRW2593	250	115	1550	150/230	6830	+690	+710	10	0,06
FRB5093	500	115	1550	150/230	8260	+830	+960	21	0,1
FRK5093	500	115	1550	150/230	10300	+1020	+960	21	0,1
FRW5093	500	115	1550	150/230	9530	+950	+960	21	0,1
FRB10093	1000	115	1550	150/230	11810	+1180	+1360	42	0,2
FRK10093	1000	115	1550	150/230	13540	+1350	+1360	42	0,2
FRW10093	1000	115	1550	150/230	13890	+1380	+1360	42	0,2
FRAV1	12	44	38		140	+10			
FRM			10		80				

# FRONT FÖRVARING STORAGE Skala Design 2007

Front förvaring. Ryggen i trä med monterade raka eller vinklade lister för tidningar, broschyrer och magasin. Bakom finns det utrymme för extra förvaring. Lister är i massiv trä och rygg i MDF av faner. Hårdat klarglas i höjd 230 mm. Som tillägg finns plexiglas. Förvaringen hängs på vägg med metallist. Specialmått och andra utförande efter förfrågan. Som tillbehör finns avdelare i massiv trä som sätts på glaslet för indelning i fack.

Front storage. Back of wood with straight or sloping ledges for magazines and brochures. Behind extra storage spaces. Ledges in solid wood and back in veneered MDF. Tempered clear glass in height 230 mm (=A4) as standard. Plexi glass, special sizes and other finishes upon request. It is secured to the wall using a metal rail. Accessories dividers in solid wood that slot on top of the glass fronts to divide each shelf into compartments.

## Raka lister. Straight ledges.

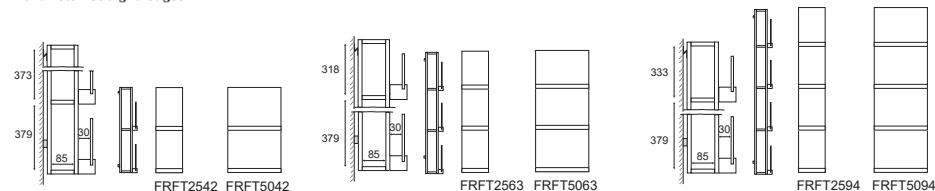

## Vinklade lister. Sloping ledges

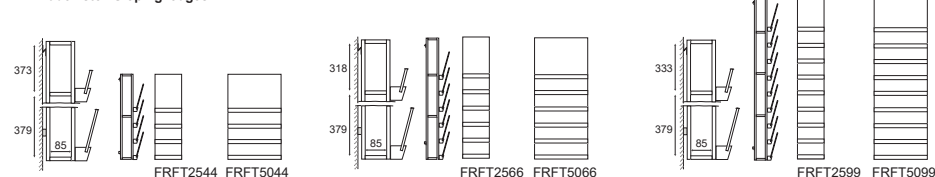

## Tillbehör Accessories



FRAV 1  
Avdelare Divider  
to FR1, FR3

Förvaring SEK	Extra SEK
---------------	-----------

Artno	Bredd Width mm	Djup Depth mm	Höjd Height mm	Glashöjd Glass height mm	.10 ek oak .20 björk birch .50 lack color	Standardbets på ek Standard stain on oak Vitpigment ek White glazed oak	Plexi FRP	Vikt Weight kilos	Volym Volume
FRFT2542	250	175	800	230	7170	+720	+480	12	0,05
FRFT5042	500	175	800	230	9410	+940	+640	22	0,1
FRFT2563	250	175	1140	230	9220	+930	+710	16	0,08
FRFT5063	500	175	1140	230	11980	+1200	+960	29	0,14
FRFT2594	250	175	1550	230	11320	+1130	+940	21	0,12
FRFT5094	500	175	1550	230	14790	+1480	+1280	40	0,2
FRFT2544	250	225	800	230	8670	+870	+940	10	0,04
FRFT5044	500	225	800	230	11840	+1190	+1280	26	0,1
FRFT2566	250	225	1140	230	11910	+1190	+1410	20	0,08
FRFT5066	500	225	1140	230	15660	+1570	+1930	26	0,15
FRFT2599	250	225	1550	230	15780	+1580	+2110	22	0,1
FRFT5099	500	225	1550	230	20850	+2090	+2880	40	0,2
Tillbehör Accessories									
FRAV1	12	44	38		140	+10			

# FRONT FRISTÅENDE FREE-STANDING

Skala Design 2006



Front fristående finns i följande tre kombinationer.

1. Utan lister med rygg i Bulletin Board 2204 eller magnetisk whiteboard inklusive magneter. 2. Tidsskriftsställ med raka eller vinklade lister monterade på en eller båda sidor av ryggen.

3. En kombination med raka eller vinklade lister med rygg i trä, Bulletin Board 2204 eller magnetisk whiteboard inklusive magneter.

Härdat klarglas i höjderna 150 (=A5) och 230 (=A4) mm. Mot tillägg finns plexiglas. Utförande foten och lister är massivt trä i ek, björk, standardfärger, standardbets på ek och vitpigmenterad ek. Ytbehandling klarlack. Specialmått och andra utförande efter förfrågan. Som tillbehör infrästa hjul i foten, ej låsbara. Extra magneter till whiteboard. Avdelare i massivt trä som sätts på glaset för indelning i fack.

Front free-standing comes in three different combinations.

1. Without ledges with back in Bulletin Board 2204 or magnetic whiteboard incl. magnets. 2. As magazine shelf with straight or slope ledges on both sides of back. 3. A combination of straight or sloping ledges and back in wood, Bulletin Board 2204 or magnetic whiteboard included magnets.

Tempered clear glass in height 150 (=A5) and 230 (=A4) mm as standard. Plexi glass upon request. Base and ledges are in solid wood of oak, birch, standard colors, standard stains on oak and white glazed oak. Finish clear lacquer. Special sizes and other finishes upon request. Accessories as invisible castors, not lockable, extra magnets for whiteboard, dividers in solid wood that slot on top of the glass fronts to divide each shelf into compartments.

**Fristående SEK** **Extra SEK**

Artno	Bredd Width mm	Djup Depth mm	Höjd Height mm	Glashöjd Glass height mm	Fothöjd Height of foot mm	.10 ek oak .20 björk birch .50 lack color	Standardbets på ek Standard stain on oak Vitpigment ek White glazed oak	+Plexi FRP	Vikt Weight kilos	Volym Volume
FRDB2560	250	360	1300		95	6670	+670		7	0,15
FRDW2560	250	360	1300		95	7670	+760		7	0,15
FRDB5060	500	360	1300		95	9530	+950		14	0,3
FRDW5060	500	360	1300		95	11730	+1180		14	0,3
FRDB10060	1000	360	1300		95	16190	+1620		28	0,6
FRDW10060	1000	360	1300		95	20240	+2020		28	0,6
FRDB2590	250	360	1750		95	7310	+730		12	0,2
FRDW2590	250	360	1750		95	8770	+880		12	0,2
FRDB5090	500	360	1750		95	10650	+1070		24	0,4
FRDW5090	500	360	1750		95	13460	+1350		24	0,4
FRDB10090	1000	360	1750		95	18090	+1810		48	0,8
FRDW10090	1000	360	1750		95	23350	+2330		48	0,8
FREB2566	250	360	1300	150,230	95	11020	+1100	+1410	13	0,15
FRET2566	250	360	1300	150,230	95	9810	+980	+1410	13	0,15
FREW2566	250	360	1300	150,230	95	11970	+1200	+1410	13	0,15
FREB5066	500	360	1300	150,230	95	16130	+1610	+1930	35	0,3
FRET5066	500	360	1300	150,230	95	14310	+1440	+1930	35	0,3
FREW5066	500	360	1300	150,230	95	18240	+1830	+1930	35	0,3
FREB10066	1000	360	1300	150,230	95	25630	+2570	+2750	52	0,52
FRET10066	1000	360	1300	150,230	95	22420	+2240	+2750	52	0,52
FREW10066	1000	360	1300	150,230	95	29550	+2960	+2750	52	0,52
FREB2599	250	360	1750	150,230	95	13880	+1380	+2110	23	0,2
FRET2599	250	360	1750	150,230	95	12500	+1250	+2110	23	0,2
FREW2599	250	360	1750	150,230	95	15230	+1520	+2110	23	0,2
FREB5099	500	360	1750	150,230	95	20540	+2060	+2880	32	0,4
FRET5099	500	360	1750	150,230	95	18290	+1830	+2880	32	0,4
FREW5099	500	360	1750	150,230	95	23260	+2320	+2880	32	0,4
FREB10099	1000	360	1750	150,230	95	32260	+3220	+4110	64	0,75
FRET10099	1000	360	1750	150,230	95	28150	+2820	+4110	64	0,75
FREW10099	1000	360	1750	150,230	95	37400	+3730	+4110	64	0,75
FRDT2566	250	360	1300	150,230	95	14180	+1430	+2820	23	0,15
FRDT5066	500	360	1300	150,230	95	20900	+2090	+3860	32	0,26
FRDT10066	1000	360	1300	150,230	95	31860	+3190	+5480	76	0,59
FRDT2599	250	360	1750	150,230	95	19060	+1900	+4230	25	0,22
FRDT5099	500	360	1750	150,230	95	28160	+2820	+5790	62	0,4
FRDT10099	1000	360	1750	150,230	95	42350	+4240	+8240	100	0,85

## Front fristående utan lister.

Rygg  
FRDB = Bulletin Board col 2204 (kantlist endast i vit, svart, ek, björk)  
FRDW = Magnetic Whiteboard (kantlist endast i vit, svart, ek, björk)

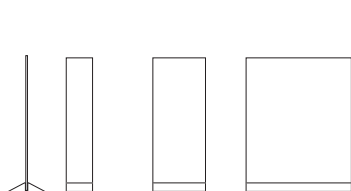

FRDB2560 FRDB5060 FRDB10060  
FRDW2560\* FRDW5060\*\* FRDW10060\*\*\*

## Front free-standing without ledges.

Back  
FRDB = Bulletin Board col 2204 (edge only in white, black, oak, birch)  
FRDW = Magnetic Whiteboard (edge only in white, black, oak, birch)

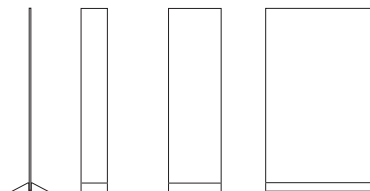

FRDB2590 FRDB5090 FRDB10090  
FRDW2590\* FRDW5090\*\* FRDW10090\*\*\*  
\*incl. 6 magnets  
\*\*incl. 8 magnets  
\*\*\*incl. 12 magnets

## Front fristående vinklade lister.

Rygg  
FREB = Bulletin Board col 2204 (kantlist endast i vit, svart, ek, björk)  
FRET = Träpanel  
FREW = Magnetic Whiteboard (kantlist endast i vit, svart, ek, björk)



FREB2566 FREB5066 FREB10066  
FRET2566 FRET5066 FRET10066  
FREW2566\* FREW5066\*\* FREW10066\*\*\*

## Front free-standing sloping ledges.

Back  
FREB = Bulletin Board col 2204 (edge only in white, black, oak, birch)  
FRET = Wooden panel  
FREW = Magnetic Whiteboard (edge only in white, black, oak, birch)

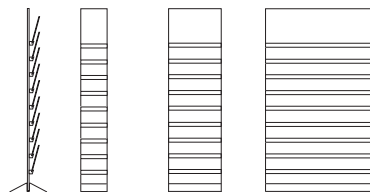

FREB2599 FREB5099 FREB10099  
FRET2599\* FRET5099\*\* FRET10099\*\*\*  
FREW2599\* FREW5099\*\* FREW10099\*\*\*  
\*incl. 3 magnets  
\*\*incl. 4 magnets  
\*\*\*incl. 6 magnets

## Front fristående vinklade lister.



FRDT2566 FRDT5066 FRDT10066

## Front free-standing sloping ledges.

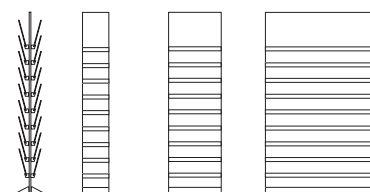

FRDT2599 FRDT5099 FRDT10099

# FRONT FRISTÅENDE FREE-STANDING

Skala Design 2006



Front fristående raka lister.



Front free-standing straight ledges.

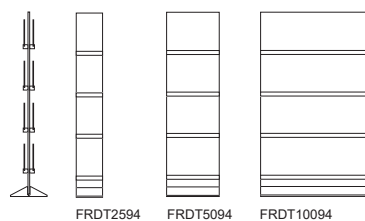

Front fristående raka lister.

Rygg  
 FREB = Bulletin Board col 2204 (kantlist endast i vit, svart, ek, björk)  
 FRET = Träpanel  
 FREW = Magnetic Whiteboard (kantlist endast i vit, svart, ek, björk)

Front free-standing straight ledges.

Back  
 FREB = Bulletin Board col 2204 (edge only in white, black, oak, birch)  
 FRET = Wooden panel  
 FREW = Magnetic Whiteboard (edge only in white, black, oak, birch)



FREB2563  
 FRET2563  
 FREW2563\*  
 FREB5063  
 FRET5063  
 FREW5063\*\*  
 FREB10063  
 FRET10063  
 FREW10063\*\*\*



FREB2594  
 FRET2594  
 FREW2594\*  
 FREB5094  
 FRET5094  
 FREW5094\*\*  
 FREB10094  
 FRET10094  
 FREW10094\*\*\*

\*incl. 3 magnets  
 \*\*incl. 4 magnets  
 \*\*\*incl. 6 magnets

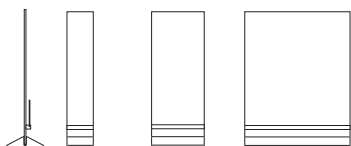

FREB2561  
 FRET2561\*  
 FREB5061  
 FRET5061\*\*  
 FREB10061  
 FRET10061\*\*\*



FREB2592  
 FRET2592\*  
 FREB5092  
 FRET5092\*\*  
 FREB10092  
 FRET10092\*\*\*

\*incl. 3 magnets  
 \*\*incl. 4 magnets  
 \*\*\*incl. 6 magnets

Tillbehör Accessories



FRAV 1  
 Avdelare Divider  
 to FR1, FR3



FRM  
 Magnet ø11



FRH  
 4st hjul ej låsbara  
 4pcs castors, not lockable

Artno	Bredd Width mm	Djup Depth mm	Höjd Height mm	Glashöjd Glass height mm	Fothöjd Height of foot mm	.10 ek oak .20 björk birch .50 lack color	Standardbets på ek Standard stain on oak Vitpigment ek White glazed oak	Plexi FRP	Vikt Weight kilos	Volym Volume
FRDT2563	250	360	1300	150,230	95	9810	+980	+1410	16	0,15
FRDT5063	500	360	1300	150,230	95	14310	+1440	+1930	32	0,3
FRDT10063	1000	360	1300	150,230	95	22420	+2240	+2750	55	0,7
FRDT2594	250	360	1750	150,230	95	11780	+1180	+1880	24	0,22
FRDT5094	500	360	1750	150,230	95	17190	+1720	+2580	34	0,4
FRDT10094	1000	360	1750	150,230	95	26580	+2660	+3670	68	0,8
FREB2563	250	360	1300	150,230	95	8850	+890	+710	14	0,16
FRET2563	250	360	1300	150,230	95	7630	+760	+710	14	0,16
FREW2563	250	360	1300	150,230	95	9780	+980	+710	14	0,16
FREB5063	500	360	1300	150,230	95	12840	+1280	+960	28	0,26
FRET5063	500	360	1300	150,230	95	11010	+1100	+960	28	0,26
FREW5063	500	360	1300	150,230	95	14950	+1490	+960	28	0,26
FREB10063	1000	360	1300	150,230	95	20910	+2090	+1370	55	0,6
FRET10063	1000	360	1300	150,230	95	17680	+1760	+1370	55	0,6
FREW10063	1000	360	1300	150,230	95	24840	+2480	+1370	55	0,6
FREB2594	250	360	1750	150,230	95	10240	+1020	+940	16	0,2
FRET2594	250	360	1750	150,230	95	8860	+890	+940	16	0,2
FREW2594	250	360	1750	150,230	95	11600	+1160	+940	16	0,2
FREB5094	500	360	1750	150,230	95	15040	+1510	+1280	32	0,4
FRET5094	500	360	1750	150,230	95	12790	+1280	+1280	32	0,4
FREW5094	500	360	1750	150,230	95	17780	+1770	+1280	32	0,4
FREB10094	1000	360	1750	150,230	95	24380	+2440	+1830	67	0,8
FRET10094	1000	360	1750	150,230	95	20280	+2020	+1830	67	0,8
FREW10094	1000	360	1750	150,230	95	29520	+2960	+1830	67	0,8
FREB2561	250	360	1300	150,230	95	7380	+740	+230	8	0,15
FRET2561	250	360	1300	150,230	95	8410	+850	+230	8	0,15
FREB5061	500	360	1300	150,230	95	10630	+1070	+330	16	0,3
FRET5061	500	360	1300	150,230	95	12840	+1280	+330	16	0,3
FREB10061	1000	360	1300	150,230	95	17780	+1770	+460	52	0,52
FRET10061	1000	360	1300	150,230	95	21790	+2180	+460	52	0,52
FREB2592	250	360	1750	150,230	95	8790	+880	+480	14	0,2
FRET2592	250	360	1750	150,230	95	10230	+1020	+480	14	0,2
FREB5092	500	360	1750	150,230	95	12860	+1280	+640	28	0,4
FRET5092	500	360	1750	150,230	95	15660	+1570	+640	28	0,4
FREB10092	1000	360	1750	150,230	95	21230	+2120	+910	56	0,8
FRET10092	1000	360	1750	150,230	95	26480	+2640	+910	56	0,8
FRAV1	12	44	38			140	+10			
FRH						1180/4pcs				

Ridå används som tidskrifts-, broschyrställ, spegel, anslagstavla, skrivtavla eller en kombination av dessa. Facken är pressad formfilt, ljusgrå eller antracit och som ger en viss ljudabsorberande effekt. Ramen tillverkas i fanerad MDF. Ytbehandling klarlack. Ridå hängs på vägg med metallist. Välj ryggen i ljusgrå alternativt antracit filt, spegel, whiteboard, trä. (Om filtack önskas kläs i tyg Comfort, återkom för offert). Samtliga ryggar är magnetiska. Ridå i bredd 371 kan hängas både vertikalt och horisontellt. Ridå fristående finns som enkel- och dubbelsidig. Tillbehör: Aluminiumlist som kan användas som namnskytt.

Ridå is used as a magazine, brochure stand, mirror, bulletin board, writing board or a combination of these. The compartments are pressed form felt, light gray or anthracite and which give a certain sound-absorbing effect. The frame is made of veneered MDF surface treatment clear lacquer. Ridå is hung on the wall with a metal strip. Choose the back in light gray alternative anthracite blanket, mirror, whiteboard, wood. (If felt compartment is desired to be upholstered in fabric Comfort, please return for a quote) All backs are magnetic. Ridå in width 371 can be hung both vertically and horizontally. Ridå freestanding is available as single and double sided. Accessories: Aluminum strip that can be used as a nameplate.

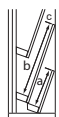

a = 110mm  
b = 200mm  
c = 25mm

### Ridå Vägghängd

Välj rygg av följande material  
RIVF = Filt ljusgrå eller antracit  
RIVS = Spegel  
RIVT = Trä  
RIVW = Whiteboard

### Ridå Wall model

Choose back of the following materials  
RIVF = Felt in light gray or anthracite  
RIVS = Mirror  
RIVT = Wood  
RIVW = Whiteboard

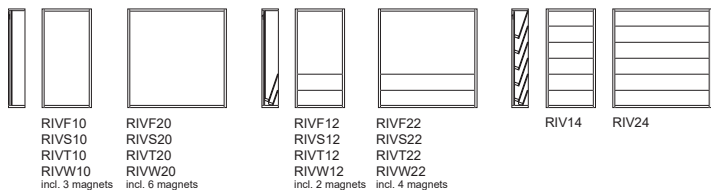

RIVF10 RIVF20  
RIVS10 RIVS20  
RIVT10 RIVT20  
RIVW10 RIVW20  
incl. 3 magnets incl. 6 magnets

RIVF12 RIVF22  
RIVS12 RIVS22  
RIVT12 RIVT22  
RIVW12 RIVW22  
incl. 2 magnets incl. 4 magnets

RIV14 RIV24

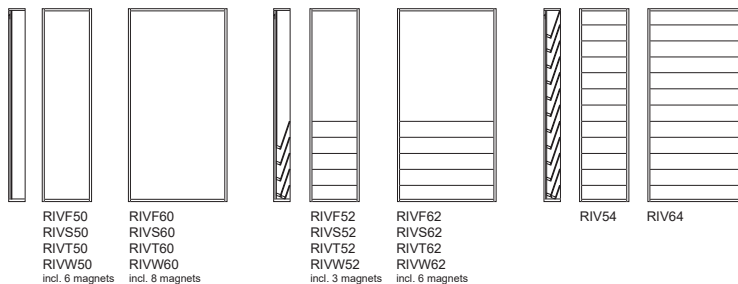

RIVF50 RIVF60  
RIVS50 RIVS60  
RIVT50 RIVT60  
RIVW50 RIVW60  
incl. 6 magnets incl. 8 magnets

RIVF52 RIVF62  
RIVS52 RIVS62  
RIVT52 RIVT62  
RIVW52 RIVW62  
incl. 3 magnets incl. 6 magnets

RIV54 RIV64

### Tillbehör Accessories



RIA

124

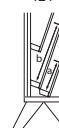

a = 110mm  
b = 200mm  
c = 25mm

### Ridå Fristående enkelsidig

Artikelnummer bestämmer framsida.  
X = välj baksida av följande material  
F = Filt ljusgrå eller antracit  
S = Spegel  
T = Trä  
W = Whiteboard

### Ridå Free-standing single side

Item number determines the front.  
X = choose back of the following materials  
F = Felt light gray or anthracite  
S = Mirror  
T = Wood  
W = Whiteboard

209

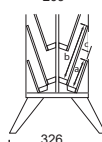

a = 110mm  
b = 200mm  
c = 25mm

### Ridå Fristående dubbelsidig

Artikelnummer bestämmer framsida.  
X = välj av följande material  
F = Filt ljusgrå eller antracit  
S = Spegel  
T = Trä  
W = Whiteboard

### Ridå Free-standing double side

Item number determines the front.  
X = choose of the following materials  
F = Felt light gray or anthracite  
S = Mirror  
T = Wood  
W = Whiteboard

Ridå Fristående dubbelsidig  
Filtack på båda sidor

Ridå Free-standing double side  
Felt pocket on both sides.

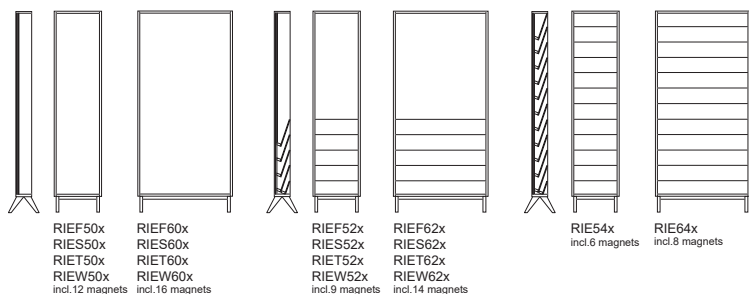

RIEF50x RIEF60x  
RIES50x RIES60x  
RIET50x RIET60x  
RIEW50x RIEW60x  
incl.12 magnets incl.16 magnets

RIEF52x RIEF62x  
RIES52x RIES62x  
RIET52x RIET62x  
RIEW52x RIEW62x  
incl.9 magnets incl.14 magnets

RIE54x RIE64x  
incl.6 magnets incl.8 magnets

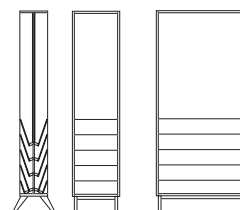

RIDF52x52 RIDF62x62  
RIDS52x52 RIDS62x62  
RIDT52x52 RIDT62x62  
RIDW52x52 RIDW62x62  
incl.6 magnets incl.12 magnets

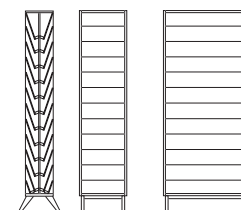

RID5454 RID6464

Artno	Bredd Width mm	Djup Depth mm	Höjd Height mm	Filtfack Felt pocket	Ridå SEK		Vikt Weight kilos	Volym Volume
					.10 ek oak .20 björk birch .50 lack color	Standardbets på ek Standard stain on oak Vitpigment ek White glazed oak		
<b>Vägghängd Wall model</b>								
RIVF10	371	124	742		5360	+530	10	0,06
RIVS10	371	124	742		5140	+520	10	0,06
RIVT10	371	124	742		5140	+520	10	0,06
RIVW10	371	124	742		5430	+540	10	0,06
RIVF20	742	124	742		6390	+640	15	0,12
RIVS20	742	124	742		6030	+600	15	0,12
RIVT20	742	124	742		6030	+600	15	0,12
RIVW20	742	124	742		6680	+670	15	0,12
RIVF12	371	124	742	ljusgrå light gray or anthracite	6220	+610	11	0,06
RIVS12	371	124	742	ljusgrå light gray or anthracite	6030	+600	11	0,06
RIVT12	371	124	742	ljusgrå light gray or anthracite	5940	+590	11	0,06
RIVW12	371	124	742	ljusgrå light gray or anthracite	6310	+630	11	0,06
RIVF22	742	124	742	ljusgrå light gray or anthracite	7650	+760	15	0,12
RIVS22	742	124	742	ljusgrå light gray or anthracite	7280	+730	15	0,12
RIVT22	742	124	742	ljusgrå light gray or anthracite	7280	+730	15	0,12
RIVW22	742	124	742	ljusgrå light gray or anthracite	7940	+780	15	0,12
RIV14	371	124	742	ljusgrå light gray or anthracite	6690	+670	11	0,06
RIV24	742	124	742	ljusgrå light gray or anthracite	8420	+850	15	0,12
RIVF50	371	124	1451		7270	+730	16	0,1
RIVS50	371	124	1451		6990	+700	16	0,1
RIVT50	371	124	1451		6990	+700	16	0,1
RIVW50	371	124	1451		7130	+720	16	0,1
RIVF60	742	124	1451		8970	+890	25	0,22
RIVS60	742	124	1451		8510	+860	25	0,22
RIVT60	742	124	1451		8510	+860	25	0,22
RIVW60	742	124	1451		9430	+940	25	0,22
RIVF52	371	124	1451	ljusgrå light gray or anthracite	9340	+930	17	0,1
RIVS52	371	124	1451	ljusgrå light gray or anthracite	9030	+900	17	0,1
RIVT52	371	124	1451	ljusgrå light gray or anthracite	9030	+900	17	0,1
RIVW52	371	124	1451	ljusgrå light gray or anthracite	9240	+930	17	0,1
RIVF62	742	124	1451	ljusgrå light gray or anthracite	12140	+1210	25	0,22
RIVS62	742	124	1451	ljusgrå light gray or anthracite	11680	+1180	25	0,22
RIVT62	742	124	1451	ljusgrå light gray or anthracite	11680	+1180	25	0,22
RIVW62	742	124	1451	ljusgrå light gray or anthracite	12620	+1260	25	0,22
RIV54	371	124	1451	ljusgrå light gray or anthracite	10200	+1010	17	0,1
RIV64	742	124	1451	ljusgrå light gray or anthracite	13140	+1310	25	0,22

Artno	Bredd Width mm	Djup Depth mm	Höjd Height mm	Filtfack Felt pocket	Ridå SEK		Vikt Weight kilos	Volym Volume
					.10 ek oak .20 björk birch .50 lack color	Standardbets på ek Standard stain on oak Vitpigment ek White glazed oak		
<b>Fristående Free-standing</b>								
RIEF50x	371	241	1574		11520	+1140	20	0,2
RIES50x	371	241	1574		11260	+1120	20	0,2
RIET50x	371	241	1574		11260	+1120	20	0,2
RIEW50x	371	241	1574		12140	+1210	20	0,2
RIEF60x	742	241	1574		15290	+1530	50	0,24
RIES60x	742	241	1574		14860	+1480	50	0,24
RIET60x	742	241	1574		14860	+1480	50	0,24
RIEW60x	742	241	1574		17120	+1710	50	0,24
RIEF52x	371	241	1574	ljusgrå light gray or anthracite	13630	+1360	25	0,2
RIES52x	371	241	1574	ljusgrå light gray or anthracite	13330	+1340	25	0,2
RIET52x	371	241	1574	ljusgrå light gray or anthracite	13330	+1340	25	0,2
RIEW52x	371	241	1574	ljusgrå light gray or anthracite	14230	+1430	25	0,2
RIEF62x	742	241	1574	ljusgrå light gray or anthracite	18470	+1840	50	0,24
RIES62x	742	241	1574	ljusgrå light gray or anthracite	18020	+1810	50	0,24
RIET62x	742	241	1574	ljusgrå light gray or anthracite	18020	+1810	50	0,24
RIEW62x	742	241	1574	ljusgrå light gray or anthracite	20280	+2020	50	0,24
RIE54x	371	241	1574	ljusgrå light gray or anthracite	14470	+1450	25	0,2
RIE64x	742	241	1574	ljusgrå light gray or anthracite	19470	+1940	50	0,24
RIDF52x52	371	326	1574	ljusgrå light gray or anthracite	17590	+1750	30	0,3
RIDS52x52	371	326	1574	ljusgrå light gray or anthracite	17280	+1730	30	0,3
RIDT52x52	371	326	1574	ljusgrå light gray or anthracite	17280	+1730	30	0,3
RIDW52x52	371	326	1574	ljusgrå light gray or anthracite	18180	+1820	30	0,3
RIDF62x62	742	326	1574	ljusgrå light gray or anthracite	22910	+2290	56	0,48
RIDS62x62	742	326	1574	ljusgrå light gray or anthracite	22470	+2250	56	0,48
RIDT62x62	742	326	1574	ljusgrå light gray or anthracite	22470	+2250	56	0,48
RIDW62x62	742	326	1574	ljusgrå light gray or anthracite	24740	+2470	56	0,48
RID5454	371	326	1574	ljusgrå light gray or anthracite	18470	+1840	30	0,3
RID6464	742	326	1574	ljusgrå light gray or anthracite	23610	+2360	56	0,48
<b>Tillbehör Accessories</b>								
RIA Aluminium	70				70			

Slope en exponeringshylla där olika höjder, bredder och tjocklekar av informationsmaterial och tidningar kan samsas.

Slope har bakåt lutande hyllplan, vilket ger en möjlighet att lägga upp tunt som tjockt material

och olika höjder utan det viker sig eller faller framåt. Slope finns i fyra höjder och fyra bredder antingen endast med lutande hyllplan eller kombination med magnetisk whiteboard eller anslagstavla i Bulletin Board färg antracit nr 2209 eller klädd filt i färgerna ljusgrå, antracit och offwhite. Vid förfrågan klädd filt i tyg Comfort från Gabriel. Upphängningen är metallist på vägg.

Tillbehör: Elastiskt band i vit eller svart som håller papper på plats.

Slope a display shelf on which you can combine informative material and magazines of varying height, width and thickness. Slope's shelves lean backwards, which enable you to display both thin and thick materials of different heights without them folding over or falling forwards. Slope is available in four heights and four widths, either with sloping shelves only or combined with a magnetic whiteboard or noticeboard covered in Bulletin Board in anthracite grey (color number 2209) or felt in color light-grey, anthracite and offwhite. Upon request covered felt in Comfort fabric from Gabriel. A metal rail is used to hang it on the wall. As an optional extra you can choose an elastic band in black or white that keeps papers, magazines, etc. in place.

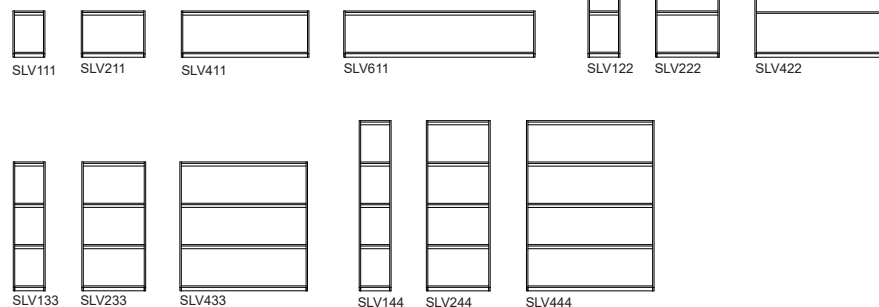
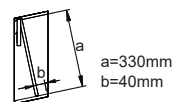

Välj rygg av följande material  
 SLVB = Bulletin Board col. 2209  
 SLVW = Magnetisk whiteboard  
 SLVF = Filt i ljusgrå, antracit eller offwhite

Choose back of the following materials  
 SLVB = Bulletin Board col. 2209  
 SLVW = Magnetic Whiteboard  
 SLVF = Felt in lightgray, anthracite or offwhite

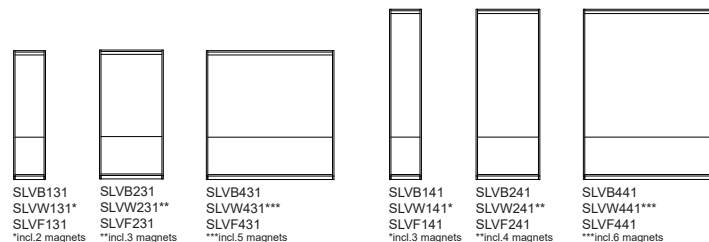

Tillbehör Accessories



Resärband vit eller svart  
 Elastic rope white or black

Artno	Bredd Width mm	Djup Depth mm	Höjd Height mm	.10 ek oak .20 björk birch	.50 lack color	Standardbets på ek Standard stain on oak Vitpigment ek White glazed oak	Vikt Weight kilos	Volym Volume
SLV111	270	143	392	3450	2730	+520	5	0,03
SLV211	540	143	392	4220	3250	+630	8	0,05
SLV411	1080	143	392	5510	4270	+830	12	0,1
SLV611	1620	143	392	7300	5420	+1100	14	0,15
SLV122	270	143	741	4610	3580	+700	8	0,05
SLV222	540	143	741	5900	4660	+890	10	0,08
SLV422	1080	143	741	8000	6290	+1200	20	0,16
SLV133	270	143	1091	5870	4780	+880	9	0,06
SLV233	540	143	1091	7650	6170	+1140	13	0,13
SLV433	1080	143	1091	10520	8290	+1580	23	0,25
SLV144	270	143	1440	7410	5970	+1110	10	0,08
SLV244	540	143	1440	9470	7490	+1430	16	0,15
SLV444	1080	143	1440	13000	10350	+1950	28	0,33
SLVB131	270	143	1091	5810	4820	+870	8	0,06
SLVW131	270	143	1091	5930	4940	+890	8	0,06
SLVF131	270	143	1091	5480	4520	+830	8	0,06
SLVB231	540	143	1091	7760	6500	+1160	13	0,13
SLVW231	540	143	1091	8020	6770	+1200	13	0,13
SLVF231	540	143	1091	7180	5900	+1080	13	0,13
SLVB431	1080	143	1091	10940	9190	+1640	23	0,2
SLVW431	1080	143	1091	11970	10240	+1800	23	0,2
SLVF431	1080	143	1091	10030	8260	+1510	23	0,2
SLVB141	270	143	1440	7190	5950	+1080	10	0,08
SLVW141	270	143	1440	7340	6100	+1100	10	0,08
SLVF141	270	143	1440	6900	5660	+1040	10	0,08
SLVB241	540	143	1440	9170	7880	+1370	16	0,15
SLVW241	540	143	1440	9580	8280	+1440	16	0,15
SLVF241	540	143	1440	8720	7440	+1310	16	0,15
SLVB441	1080	143	1440	13110	11470	+1970	28	0,33
SLVW441	1080	143	1440	14430	12800	+2170	28	0,33
SLVF441	1080	143	1440	12550	10910	+1880	28	0,33
<b>Tillbehör Accessories</b>				<b>per styck each</b>				
Resär vit eller svart. Elastic white or black	270			130				
Resär vit eller svart. Elastic white or black	540			140				
Resär vit eller svart. Elastic white or black	1080			160				
Resär vit eller svart. Elastic white or black	1620			220				



Ray finns i höjd 1600 mm, en rak modul i längd 630 mm och två svängda 30-gradiga moduler med två olika radier 800 respektive 1400 mm. Vissa kombinationer kräver en fot i pulverlackad metall för att uppnå hög stabilitet. Om modulerna ska förankras i golv var vänlig notera på underlag/beställning. Varje spaljé är försedd med filtassar. Modulerna kommer monterade och hopkopplingen sker med dolda beslag.

Utförande är i massiv ek, ask, standardbetsler på ask och vitpigmenterad ek eller ask. Ändavslut i metall, RAL 1019 Gray beige som standard till ek och ask samt RAL 9005 svart och RAL 9016 vit som tillval. Med hjälp av handverktyg är de olika modulerna enkla att separera.

Vid beställning: ange artikelnummer, utförande och om modulerna ska förankras i golv.

Ray room divider is 1600 mm high. It comes as a straight module 630 mm long, and as two 30° modules with a radius of 800 mm and 1400 mm respectively. For optimum stability certain combinations require a foot in powder-lacquered metal. If the modules are to be anchored to the floor, please note on the request / order. Each module is equipped with felt floor protectors. Modules are supplied assembled, ready to be linked with concealed link fittings. Ray comes in a choice of solid oak or ash, standard stains on ash and white glaze on oak or ash. End finish in metal, RAL 1019 Gray beige as standard for oak and ash and RAL 9005 black and RAL 9016 white as options.

With the help of hand tools, the different modules are easy to separate. Hand tools are all that is required to simply separate the different modules.

State when ordering: article number, finish and if the modules need to be anchored to the floor.

Artno

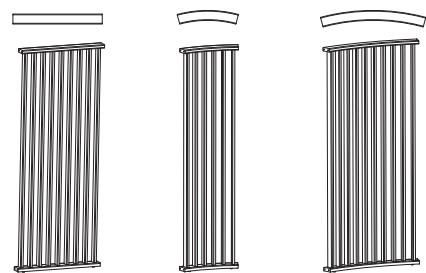

RAYR16063  
RAYC16080 Radie 800  
RAYC160140 Radie 1400



RAYFOTs svart black RAL 9005  
RAYFOTv vit white RAL 9016  
RAYFOTb gray beige RAL 1019

Förslag Suggestionss



Komb 1  
5xRAYC16080, 2xRAYFOT  
H1600 L2088 D70/370

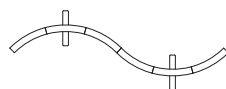

Komb 2  
6xRAYC16080, 2xRAYFOT  
H1600 L2310 D400

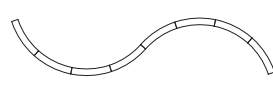

Komb 3  
8xRAYC16080  
H1600 L2830 D870

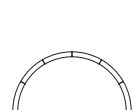

Komb 4  
6xRAYC16080  
H1600 B1670 D835

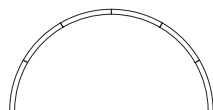

Komb 5  
6xRAYC160140  
H1600 L2870 D1435

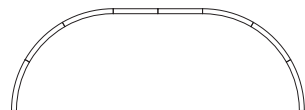

Komb 6  
6xRAYC160140, 2xRAYR16063  
H1600 L4130 D1435



Komb 7  
3xRAYR16063, 2xRAYFOT  
H1600 L1890 D70/370

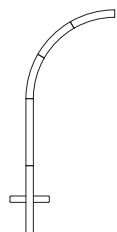

Komb 8  
2xRAYR16063, 3xRAYC16080, 1xRAYFOT  
H1600 L2095 D930

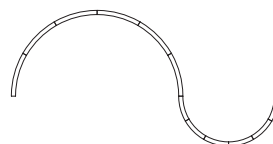

Komb 9  
6xRAYC16080, 6xRAYC160140  
H1600 L4470 D2270

Artno		Bredd Width mm	Djup Depth mm	Höjd Height mm	Ray SEK		Extra SEK	Vikt netto Weight net kilos	Vikt brutto Weight gross kilos	Volym Volume
					.10 ek oak	.30 ask ash	Standardbets på ask Standard stain on ash Vitpigment ek, ask White glazed oak, ash			
RAYR16063	Rak Straight	630	70	1600	6160	5070	+760	12	16	0,11
RAYC16080	Radie 800	430	70	1600	4820	4020	+600	8	14	0,11
RAYC160140	Radie 1400	740	70	1600	6910	5610	+1050	14	20	0,2
<b>Tillbehör Accessories</b>										
RAYFOTs svart black RAYFOTv vit white RAYFOTb beige		370	60	4	290 / styck pcs					

Mattan **Solveig** är specialutformad efter rumsavdelaren Rays svängda form. Mattan är tillverkad av spillmaterial och består av sektioner där de solstrålar som strilar genom spaljén fångas upp. På mattan finns utrymme för en mindre möbelgrupp eller ett större matbord. Mattan är designad av Indicum inredningsarkitekter och tillverkad hos Stoddard Ateljé som gör unika återbruksmattor.

Materialet kommer från spillmaterial, som under åren byggts upp till ett stort lagerarkiv av fina rullar. Varje matta blir unik och 100% återbrukad. Solveig finns i fyra olika utföranden med tre olika färgställningar, grön, beige och lila. Andra kulörer kan tas fram efter förfrågan hos Indicum. Material tas alltid fram med hänsyn till befintligt restlager hos Stoddard.

Nedan följer exempel på hur mattan kan passa till några olika kombinationer.

För förfrågningar om mattan, färger och pris mm var vänlig kontakta [info@stoddard.se](mailto:info@stoddard.se)

The carpet **Solveig** is specially designed after the curved shape of the room divider Ray. The carpet is made from waste material and consists of sections where the sun's rays that shine through the trellis are captured. There is space on the carpet for a smaller group of furniture or a larger dining table. The carpet is designed by Indicum Interiorarchitects and manufactured at Stoddard Ateljé, which makes unique recycled carpets. The material comes from waste material, which over the years has been built up into a large stock archive of fabric rolls. Each carpet is unique and 100% recycled. Solveig is available in four different versions with three different color schemes, green, beige and purple. Other colors can be produced upon request from Indicum. Materials are available according to existing residual stock at Stoddard. For inquiries about the carpet, prices etc. please contact [info@stoddard.se](mailto:info@stoddard.se)

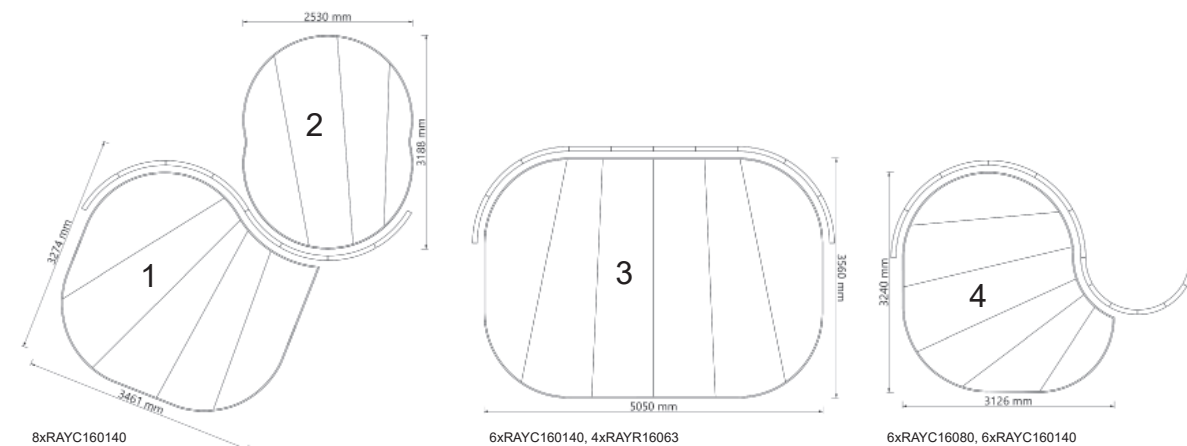

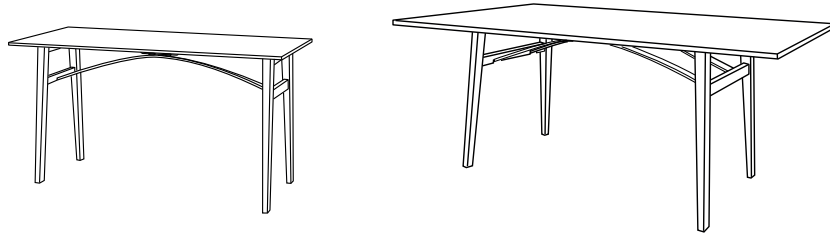

## Fällbart bord.

Bordsskiva av trälamell med faner i ek, ask, björk, standardbetser på ask och vitpigmenterad ek och ask. Alternativt högtryckslaminat ek, björk, ask, vit och svart matt samt svart desktop. Ben i massivt trä av ek, ask, björk, standardbetser på ask och vitpigmenterad ek och ask. Ytbehandling klarlack. Specialmått och andra utförande efter förfrågan. Bordet levereras monterat.

## Folding table.

The table top made from blockboard finished in natural oak, ash, birch veneer, standard stains on ash and white glaze on oak and ash. High Pressure Laminate of oak, birch, ash, white laminate, black matte laminate and black desktop. Legs in solid wood of oak, ash, birch, standard stains on ash and white glazed on oak and ash. Finish clear lacquer. Special sizes and other finishes upon request. The table comes pre-assembled.

Artno

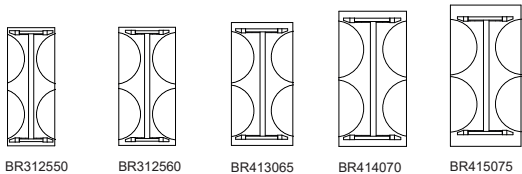

BR312550 BR312560 BR413065 BR414070 BR415075

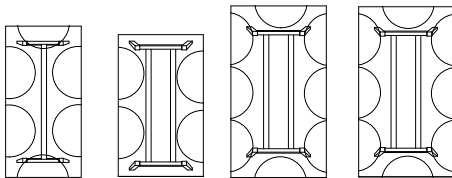

BR416080 BR515090 BR518090 BR5180100

Tillbehör Accessories

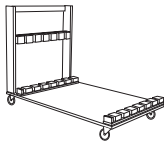

**BRV7**  
Vagn. Plats för 8 bord. Björk  
Trolley. For 8 tables. Birch

## Brygga SEK

## Extra SEK

Artno	Längd Length mm	Bredd Width mm	Höjd Height mm	Top Faneer Veneer Ben Legs .10 ek oak .20 björk birch .30 ask ash	Top Vit White laminate Ben Legs .61 ek oak .62 björk birch .63 ask ash	Top Svart matt Black Laminate Ben Legs .65 ek oak .66 björk birch .67 ask ash	Top Svart Black Desktop Ben Legs .91 ek oak .92 björk birch .93 ask ash	Standardbets på ask på skiva+ben Standard stain on ash on top+legs  Vitpigment ek ask White glazed oak ash	Avstånd mellan ben Distance between legs	Vikt brutto Weight gross kilos	Volym Volume
BR3 12550	1250	500	720	11620	11810	12440	11640	+1880	1080	16	0,12
BR3 12560	1250	600	720	12560	12730	13440	13100	+2080	1080	18	0,15
BR4 13065	1300	650	720	13050	13220	13970	13640	+2100	1080	25	0,15
BR4 14070	1400	700	720	13990	14180	14990	14670	+2190	1080	27	0,16
BR4 15075	1500	750	720	14100	14330	15130	14940	+2300	1200	29	0,21
BR4 16080	1600	800	720	15080	15300	16090	15950	+2510	1200	34	0,25
BR5 15090	1500	900	720	16890	17090	18130	17720	+2790	1200	31	0,25
BR5 18090	1800	900	720	17900	18140	19160	18780	+2960	1200	45	0,30
BR5 180100	1800	1000	720	18970	19320	19100	20040	+3120	1200	50	0,31
				<b>Tillbehör SEK Accessories</b>							
BRV7 vagn trolley	1250	760	950	12860 björk birch						35	1,0

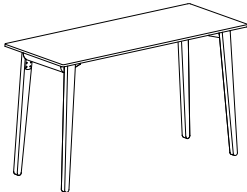

Träben Legs of wood



Stålbén Legs of steel

#### Fällbord

##### SKIVA

Träfanerad MDF i ek, björk, ask, standardbets på ask, vitpigmentrad ek och ask. Ybehandling klarlack.  
Vit laminat NCS S0502-G50Y.  
Svart laminat Fenix NTM 0720 Nero Ingo, S8500-N  
Svart desktop nr 4023 nero, NCS S9000-N.  
Högtryckslaminat ek nr F5374 NAT, björk nr F7555 MAT, ask nr F8843 NAT. (PR3140 finns ej i ek, björk, ask laminat)  
Tjocklek: Rektangulär skiva 13mm. Rund skiva 17mm.

##### KANTLIST

Massiv trä ek, ask eller björk.  
Standardbets på ask, endast på träfanerad skiva i samma färg.  
Vit eller svart, ABS.

##### BEN

Ihopfällda höjd 85mm.  
Träben i massiv ek, björk, ask, standardbets på ask och vitpigment ek och ask. Ybehandling klarlack.  
Stålbén i blankkrom, cr3+.  
Stålbén i pulverlack med finstruktur i svart RAL9005 eller grå RAL9006/07.  
Filtass på samtliga bord.  
Vid behov av större avstånd mellan långsidans ben vänligen kontakta [info@karl-andersson.se](mailto:info@karl-andersson.se)

##### STAPLINGS- OCH KLÄMSKYDD

Filt färg antracit som standard.  
Som tillval och ska noteras på order ljusgrå eller offwhite filt.

##### TILLBEHÖR

Ljudabsorbent under bordsskiva, kan ej kombineras med eluttag.  
Bordspanel antracit filt som hängs på krokar. Eller som tillval ljusgrå eller offwhite filt.  
Kopplingsbeslag för kortsida och vissa storlekar för långsida.  
Två hjul, ej läsbara vilket ger något ökad rörlighet mot golvet (endast för träben).  
Eluttag - tre varianter. Anslutningskabel 5 meter, med jordad Schucko stickpropp och vidarekopplingskabel 3 meter, för seriekoppling mellan bord.  
Förvaringsvagn med handtag i metall kan placeras på kortsida (plats för 13 bord) eller långsidan (plats för 7 bord), läsbara hjul. För bord med längd 1600 mm och längre rekommenderas att de transporteras liggande varför handtaget ska monteras på vagnens långsida.

##### ÖVRIGT

Specialmått och andra utförande efter förfrågan. Bordet levereras monterat.

##### VID ORDER ANGE

Artikelnummer, på bord och tillbehör. Utförande på skiva, kantlist, ben och färg på staplings- och klämskydd.

#### Folding table

##### TOP

Wooden top veneered on MDF in oak, birch, ash, standard stain on ash, white glazed on oak or ash. Finish clear lacquer.  
White laminate NCS S0502-G50Y.  
Black laminate Fenix NTM 0720 Nero Ingo, S8500-N  
Black desktop no 4023 nero, NCS S9000-N.  
High Pressure Laminate oak no F5374 NAT, birch no F7555 MAT, ash no F8843 NAT. (PR3140 not available in HPL)  
Thickness: Rectangulare top 13mm. Round top 17mm.

##### EDGE

Solid wood in oak, birch, ash.  
Standard stain on ash, only on wooden top in same color.  
White or black ABS.

##### LEGS

Folding height 85mm.  
Solid wood in oak, birch, ash, standard stain on ash, white glazed on oak or ash. Finish clear lacquer.  
Steel in finish polished chrome, cr3+.  
Steel in finish powder coating with fine texture in black RAL9005 or gray RAL9006/07.  
All tables have felt floor protection.  
If you need a greater distance between the legs of the long side, please contact [info@karl-andersson.se](mailto:info@karl-andersson.se)

##### STACKING- / SAFTEY COVER

Felt in color anthracite as standard.  
As option color and state when ordering light gray or offwhite felt.

##### ACCESSORIES

Sound-absorbent panel for concealed installation under the tabletop, which cannot be combined with electrical outlets.  
Modesty panel in antrachite felt which hangs on hooks, or lightgray or offwhite.  
Two wheels which are note lockable, giving slightly mobility to the floor, (only for wooden legs).  
Link fittings short side to short side. Some tables even for long side.  
Power outlet - three different types. Start cable 5metres, with saftey plug, Schuko and cable to connect 3metres, with other tables.  
Storage trolley with locking wheels and a metal handle, placed either on the short end (for 13 tables) or the long side (7 tables).  
For tables with a length 1600mm or longer we recommend that they are transported horizontally, which means that the handle is to be mounted on the trolley's long side.

##### MORE INFORMATION

Special sizes and other finishes upon request. The table comes pre-assembled.

##### STATE WHEN ORDERING

Article number for table and accessories. Execution on table top, edge, legs and color of stacking- / saftey cover.

Artno

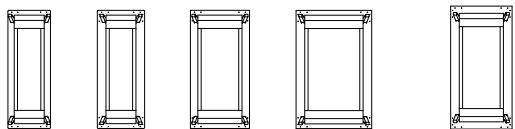

PR112545 PR112550 PR112562 PR112580 PR113065

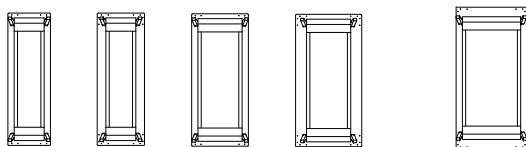

PR114045 PR114050 PR114060 PR114070 PR115075

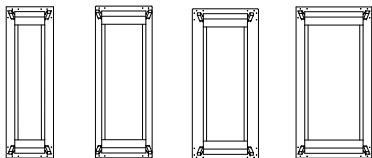

PR116050 PR116060 PR116070 PR116080

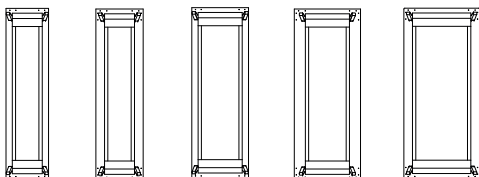



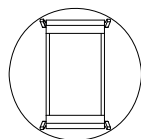



PR118045 PR118050 PR118060 PR118070 PR118080

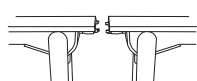

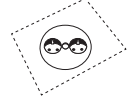
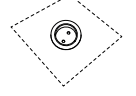
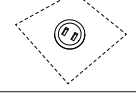
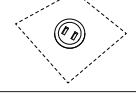
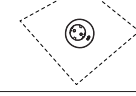
PR3140\*

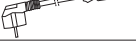
\*finns ej i laminat ek, björk, ask  
\*not in laminate oak, birch, ash

Tillbehör Accessories	Artno	Mått Dimension mm		SEK
	PRK		<b>Kopplingsbeslag.</b> Alla bord kan kopplas kortsida mot kortsida. Följande bord kan kopplas långsida mot långsida. PR1 12550, PR1 13065, PR1 14050, PR1 14070, PR1 16080, PR1 18050, PR1 18070, PR1 18080. <b>Observera!!</b> priset är baserat på koppling kortsida mot kortsida alternativt långsida mot långsida. Link fittings. All tables can be connected short side to short side. The following table can be connected long side to long side. PR1 12550, PR1 13065, PR1 14050, PR1 14070, PR1 16080, PR1 18050, PR1 18070, PR1 18080. Note!! The price is for link fittings short side to short side or long side to long side.	590
	PRH		<b>Hjul endast till träben.</b> Monterat på två bordssben, grå. Ej låsbara vilket ger något ökad rörlighet mot golvet. Castors only to the wooden legs. Placed on two legs, grey. Not lockable, giving slightly mobility to the floor.	390/2pcs
	TKB7P	ø115	<b>Twist. Lock borstat rostfritt stål. 2 eluttag 220V. 2 kabelhållare exkl kablar. Gäller för SE,NO,DK,FIN,DE,NL</b> Twist. Brushed stainless lid. 2 Electrical outlets 220V. 2 cable holders excl. cables. For SE,NO,DK,FIN,DE,NL	3280
	TKB11P	ø57	<b>Powerdot Mini. 1 eluttag, svart, 2 kabelhållare exkl kablar. Gäller för SE,NO,DK,FIN,DE,NL.</b> Powerdot Mini. 1 electrical black, 2 cable holders excl. cables. For SE,NO,DK,FIN,DE,NL	1390
	TKB12P	ø57	<b>Powerdot Mini. USB A laddare inkl. 2 portar, svart. Kabelhållare exkl kablar. Gäller för SE,NO,DK,FIN,DE,NL.</b> Powerdot Mini USB A charging incl. 2 ports, black. 2 cable holders excl. cables. For SE,NO,DK,FIN,DE,NL	1810
	TKB19P	ø57	<b>Powerdot Mini. USB C laddare inkl. 2 portar, svart. Kabelhållare exkl kablar. Gäller för SE,NO,DK,FIN,DE,NL.</b> Powerdot Midi. USB C charging 2 ports, black. 2 cable holders excl. cables. For SE,NO,DK,FIN,DE,NL	2000
	TKB20P	ø70	<b>Powerdot Midi. 1 eluttag, 1 USB C laddare, svart. Kabelhållare exkl kablar. Gäller för SE,NO,DK,FIN,DE,NL.</b> Powerdot Midi. 1 electrical, 1 USB C charging, black. 2 cable holders excl. cables. For SE,NO,DK,FIN,DE,NL	2000
	TKB9P	L 155 W 63	<b>Kabelgenomföring. Lock i borstat rostfritt stål. 3 jordade eluttag på undersidan av bordsskivan. 2 kabelhållare, exkl. kablar. Gäller för SE,NO,DK,FIN,DE,NL, andra länder mot offert.</b> Cable slot. Brushed stainless steel lid. 3 electrical outlets placed under the table top. 2 cable holders, excl. cables. For SE,NO,DK,FIN,DE,NL other countries upon request	1550
	PRCA5	L 5000	<b>Anslutningskabel. 5 meter med jordad Schuko stickpropp</b> Start cable. 5 meters with safety Schuko plug	460
	PRCV3	L 3000	<b>Vidarekopplingskabel. 3 meter, för seriekoppling mellan bord.</b> Connecting cable 3 meters between tables.	370
	PRV	L 1210 W 700 H 1057	<b>Vagn. Låsbara hjul. Handtag kan monteras på lång- eller kortsida. För bord med längd 1600 mm och längre rekommenderas att borden transporteras liggande, varför handtaget ska monteras på vagnens långsida. Plats antal bord, handtag kortsida 13st. Plats antal bord, handtag långsida 7st.</b> Trolley. Lockable castors. Handle mounted on long- or shortside. For tables with a length 1600 mm and longer, we recommend that they are transported horizontally, which means that the handle is to be mounted on the trolley's long side. Numbers of table, 13pcs handle on shortside. Numbers of table, 7pcs handle on longside. 16kg 1,0k <sup>3</sup>	7460



Artno	Längd Length mm	Bredd Width mm	Diam. mm	Höjd Height mm	Press SEK				Extra SEK					Avdrag Reduction		
					Top faneer veneer Ben Legs .10 ek oak .20 björk birch .30 ask ash	Top Vit White Laminate Ben Legs .61 ek oak .62 björk birch .63 ask ash	Top Svart Black Laminate Ben Legs .65 ek oak .66 björk birch .67 ask ash	Top Svart Black Desktop Ben Legs .91 ek oak .92 björk birch .93 ask ash	Standardbets på ask skiva+ben Standard stain on ash top+legs	Standardbets på ask skiva Standard stain on ash top	Standardbets på ask ben Standard stain on ash legs	Höjd Height 900mm	Bordspanel filt H280mm Modesty panel felt H280mm	Ljudabsorbent Sound absorber	Stälben blankkrom Steel legs polished chrome	Stälben pulverlack svart eller grå Steel legs powder coating black or gray
PR112545	1250	450		725	9020	9210	9860	9530	+1370	+400	+960		+990	+480	+460	/.620
PR112550	1250	500		725	9120	9300	9930	9620	+1370	+400	+960		+990	+480	+460	/.620
PR112562	1250	625		725	9550	9730	10430	10120	+1440	+480	+960		+990	+700	+460	/.620
PR112580	1250	800		725	10640	10840	11540	11210	+1600	+480	+1080		+990	+700	+460	/.620
PR113065	1300	650		725	9920	10110	10920	10540	+1470	+490	+990		+1040	+700	+460	/.620
PR114045	1400	450		725	9510	9690	10450	10150	+1430	+410	+1000		+1190	+480	+460	/.620
PR114050	1400	500		725	9580	9750	10500	10230	+1440	+430	+1000		+1190	+480	+460	/.620
PR114060	1400	600		725	10010	10200	10980	10670	+1510	+490	+1000		+1190	+700	+460	/.620
PR114070	1400	700		725	10140	10340	11150	10830	+1550	+530	+1000		+1190	+700	+460	/.620
PR115075	1500	750		725	11470	11690	12490	12310	+1730	+590	+1130		+1210	+700	+460	/.620
PR116050	1600	500		725	10350	10540	11310	11170	+1710	+560	+1140	+580	+1230	+650	+460	/.620
PR116060	1600	600		725	10780	10980	11780	11630	+1710	+560	+1140	+580	+1230	+990	+460	/.620
PR116070	1600	700		725	11070	11260	12050	11910	+1710	+560	+1140	+580	+1230	+990	+460	/.620
PR116080	1600	800		725	11720	11940	12730	12590	+1750	+600	+1140		+1230	+990	+460	/.620
PR118045	1800	450		725	10470	10650	11440	11290	+1580	+530	+1040	+580	+1260	+640	+460	/.620
PR118050	1800	500		725	10600	10780	11560	11420	+1600	+540	+1040	+580	+1260	+640	+460	/.620
PR118060	1800	600		725	11020	11210	12110	11870	+1650	+560	+1100	+580	+1260	+990	+460	/.620
PR118070	1800	700		725	11210	11410	12290	12060	+1690	+580	+1100	+580	+1260	+990	+460	/.620
PR118080	1800	800		725	11970	12190	13180	12850	+1810	+640	+1190		+1260	+990	+460	/.620
PR3140*			ø1400	730	12330	12500	13440	13240	+1600	+510	+1090		+700	+460	+460	/.620

\*finns ej i laminat ek, björk, ask  
\*not in laminate oak, birch, ash

Information

Artno	Vikt netto Weight net kilos	Vikt brutto Weight gross kilos	Volym Volume	Ihopfällt Folding mm	*Avstånd ben långsida avser sitthöjd 450mm *Distance legs long side, refers to seat height 450mm mm	Avstånd ben kortsida avser sitthöjd 450mm Distance legs short side, refers to seat height 450mm mm	Kopplingsbart kort sida Connected short side	Kopplingsbart långsida Connected long side
PR112545	13	16	0,09	85	1027	343	YES	----
PR112550	13,5	18	0,09	85	1027	343	YES	YES
PR112562	15	20	0,11	85	1027	493	YES	----
PR112580	16	24	0,14	85	1027	643	YES	----
PR113065	16	22	0,11	85	1027	493	YES	YES
PR114045	14	20	0,12	85	1177	343	YES	----
PR114050	14,5	22	0,12	85	1177	343	YES	YES
PR114060	16	26	0,13	85	1177	493	YES	----
PR114070	17	26	0,14	85	1177	493	YES	YES
PR115075	19	28	0,15	85	1177	643	YES	----
PR116050	17	26	0,13	85	1377	343	YES	YES
PR116060	17,5	26	0,14	85	1377	493	YES	----
PR116070	19	28	0,15	85	1377	493	YES	YES
PR116080	21	30	0,17	85	1377	643	YES	YES
PR118045	15,5	22	0,13	85	1577	343	YES	----
PR118050	16,5	24	0,13	85	1577	343	YES	YES
PR118060	20	26	0,16	85	1577	493	YES	----
PR118070	20,5	28	0,18	85	1577	493	YES	YES
PR118080	22	30	0,20	85	1577	643	YES	YES
PR3140	31	40	0,20	85	1027	643	----	----

\*Vid behov av större avstånd mellan långsidans ben vänligen kontakta [info@karl-andersson.se](mailto:info@karl-andersson.se)  
 \*If you need a greater distance between the legs of the long side, please contact [info@karl-andersson.se](mailto:info@karl-andersson.se)



H 730

H 900

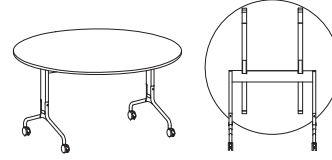

RO5 160, RO5 180, RO5 200  
ihopkopplad connected

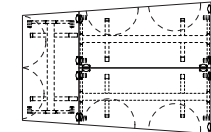

Exempel ihopkoppling av trapezoidbord  
Example of connecting a trapezoidal table

### Fällbord.

Rollo fälls med ett fjäderande tvåhåndsgrepp som gör att bordet är enkelt att fälla och ger maximalt utrymme för karmstolar men som också säkerställer att skivan inte fälls upp av misstag. Bordsskivan är även balanserad så att den fällda skivan alltid står i rakt uppfällt läge. Bord med uppfälld skiva kan sättas ihop och staplas sidledes i varandra. Bordsskivan är i fanerad MDF av ek, ask, björk, standardbetser på ask, vitpigmenterad ek eller ask. Alternativt högtryckslaminat (vit, svart, ek, björk, ask) och svart desktop. Balk och gavel är i massivt trä, utförande lika bordsskivan. Kantlistens utföranden, på bordsskivan är rak och följer balk och gavel. Benavslut av metall med ytbehandling av pulverlackad finstruktur i vit (RAL 9016), svart (RAL 9005) alternativt grå (RAL9006/07). Bordet är försedd med fyra svarta låsbara hjul.

Tillval till rektangulära bordet är kopplingsbeslag, bordsfront och olika eluttag. När bord är försedd med eluttag fälls och ställs undan förvaras kablarna i balken som är monterad under bordsskivan. Bordet levereras omonterat. Bengavlarna monteras på bordsbalken. Vid behov kan samtliga delar enkelt demonteras med enkla handverktyg.

### Folding table.

A spring-loaded construction ensures that Rollo opens easily with a two-handed grip, providing the maximum space for chairs with arms while also ensuring that the table cannot fold up accidentally. The tabletop is carefully balanced so that it is always perfectly level when unfolded. When folded, tables can be placed close together and stacked side by side.

The tabletop is made of veneered MDF, finished in oak, ash, birch, standard stains on ash, white glaze on oak or ash. The table top is also available in High Pressure Laminate (white, black, oak, ash, birch) or black desktop. The centre beam and ends are of solid wood in the same finish as the top. The edge of table top is straight and finish is the same as the centre beam and ends. Table legs terminate in a metal foot with a finely textured powder lacquer finish in white (RAL 9016), black (RAL 9005) or grey (RAL9006/07). Each table is fitted with four black wheels that can be locked in place.

Link fittings, table aprons and various electric outlets are available as optional extras. Tables equipped with electric outlets have cable ducts with a wooden finish, so cables can be kept in place under the tabletop when the table is folded for storage. The table is supplied unassembled. The leg frames are to be fitted to the central beam. If required, the table can be easily dismantled into its component parts using only simple hand tools.

### Artno

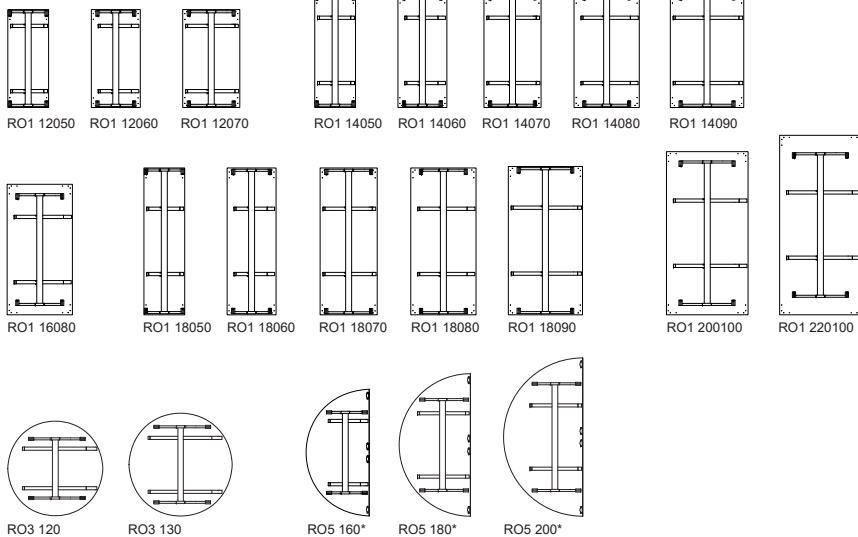

RO1 12050 RO1 12060 RO1 12070 RO1 14050 RO1 14060 RO1 14070 RO1 14080 RO1 14090

RO1 16080 RO1 18050 RO1 18060 RO1 18070 RO1 18080 RO1 18090 RO1 200100 RO1 220100

RO3 120 RO3 130 RO5 160\* RO5 180\* RO5 200\*

### Example of combination

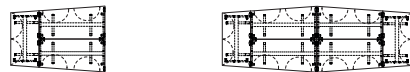

**KOMB 1** L2000 W1150/1400  
RO6 14067H  
RO6 14067V  
RO6E 12060

**KOMB 2** L4000 W 1115/1400  
2 x RO6E 12060  
2 x RO6 14067H  
2 x RO6 14067V

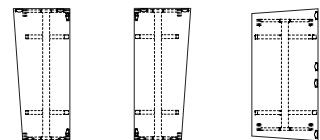

RO6 14056V\*\* RO6 14056H\*\* RO6E 10060\*  
RO6 14067V\*\* RO6 14067H\*\* RO6E 12060\*  
RO6 14078V\*\* RO6 14078H\*\* RO6E 14070\*

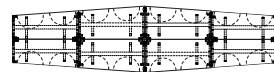

**KOMB 3** L5600 W 1000/1400  
2 x RO6 14056H  
2 x RO6 14056V  
2 x RO6 14067H  
2 x RO6 14067V

\*inkl. 4st kopplingsbeslag  
\*inkl. 4pcs link fittings

\*\*inkl. 6st kopplingsbeslag  
\*\*inkl. 6pcs link fittings

Tillbehör Accessories	Artno	Dimension mm		SEK
	TKB7R	ø115	<b>Twist. Lock borstat rostfritt stål. 2 Eluttag. 2m kabel. Gäller för SE, NO, DK, FIN, DE, NL.</b> Twist. Brushed stainless lid. 2 Electrical. 2m cables. For SE, NO, DK, FIN, DE, NL.	2720
	TKB11R	ø57	<b>Powerdot Mini. 1 eluttag, svart, 1,5m kabel. Gäller för SE,NO,DK,FIN,DE,NL.</b> Powerdot Mini. 1electrical black, 1,5m cable. For SE,NO,DK,FIN,DE,NL	1000
	TKB12R	ø57	<b>Powerdot Mini. USB A laddare inkl. 2 portar, svart. 1,5m kabel. Gäller för SE,NO,DK,FIN,DE,NL.</b> Powerdot Mini. USB charging incl. 2 ports, black. 1,5m cable. For SE,NO,DK,FIN,DE,NL	1350
	TKB19R	ø57	<b>Powerdot Mini. USB C laddare inkl. 2 portar, svart. 1,25m kabel. Gäller för SE,NO,DK,FIN,DE,NL.</b> Powerdot Midi. USB C charging 2 ports, black. 1,25m cable. For SE,NO,DK,FIN,DE,NL	1630
	TKB20R	ø70	<b>Powerdot Midi. 1 USB C laddare, svart. 1,25m kabel. Gäller för SE,NO,DK,FIN,DE,NL.</b> Powerdot Midi. 1 electrical, 1 USB C charging, black. 1,25m cable. For SE,NO,DK,FIN,DE,NL	1630
	ROK		<b>Kopplingsbeslag. Rektangulära bord kan kopplas på kort- och långsida. Observera! priset är baserat på koppling kortsida mot kortsida alternativt långsida mot långsida.</b> Link fittings. Rectangulare tables can be connected short side to short side or longside to longside. Note! The price is for link fittings short side to short side or long side to long side.	590
	ROFRP	L1200 L1400 L1600 L1800 L2000 L2200	<b>Bordspanel. Fanerad MDF. Upphängningskrok svart. Modesty panel. Veneered MDF. Hook in black.</b>	pris sid. 48 price page 48

Artno	Längd Length mm	Bredd Width mm	Höjd Height mm	Diam mm	Rollo SEK				Extra SEK				Vikt netto Weight net kilos	Vikt brutto Weight gross kilos	Volym Volume
					Top faneer veneer Ben Legs .10 ek oak .20 björk birch .30 ask ash	Top Vit White Laminate Ben Legs .61 ek oak .62 björk birch .63 ask ash	Top Svart Black Laminate Ben Legs .65 ek oak .66 björk birch .67 ask ash Top Laminate Ben Legs .71 ek oak .72 björk birch .73 ask ash	Top Svart Black Desktop Ben Legs .91 ek oak .92 björk birch .93 ask ash	Standardbets på ask skiva Standard stain on ash top  Vitpigment White glazed	Standardbets på ask ben Standard stain on ash legs  Vitpigment White glazed	Höjd Height 900mm	Bordspanel Modesty panel H300			
RO1 12050	1200	500	730		11070	11240	11860	11560	+240	+510	+320	+1100	19	24	0,15
RO1 12060	1200	600	730		11240	11410	12090	11790	+250	+510	+320	+1100	22	27	0,17
RO1 12070	1200	700	730		11810	11980	12690	12360	+300	+510	+320	+1100	25	30	0,2
RO1 14050	1400	500	730		11900	11990	12740	12530	+290	+560	+320	+1160	22	27	0,16
RO1 14060	1400	600	730		12080	12250	12960	12730	+300	+560	+320	+1160	25	30	0,2
RO1 14070	1400	700	730		12690	12870	13660	13330	+340	+560	+320	+1160	28	33	0,22
RO1 14080	1400	800	730		12870	13070	13850	13520	+350	+560	+320	+1160	32	37	0,23
RO1 14090	1400	900	730		15160	15350	16150	15800	+380	+560	+320	+1160	36	41	0,23
RO1 16080	1600	800	730		14950	15170	16020	15740	+560	+560	+320	+1240	31	36	0,25
RO1 18050	1800	500	730		15110	15320	16060	15850	+500	+630	+320	+1390	28	33	0,2
RO1 18060	1800	600	730		15350	15570	16300	16180	+520	+630	+320	+1390	32	36	0,22
RO1 18070	1800	700	730		16060	16280	17060	16980	+570	+630	+320	+1390	36	40	0,25
RO1 18080	1800	800	730		16320	16560	17390	17340	+590	+630	+320	+1390	40	45	0,28
RO1 18090	1800	900	730		18710	18950	19810	19750	+630	+630	+320	+1390	44	50	0,33
RO1 200100	2000	1000	730		20000	20290	21280	21130	+760	+630	+320	+1460	45	50	0,4
RO1 220100	2200	1000	730		20300	20610	21610	21420	+780	+630	+320	+1520	55	61	0,41
RO3 120			730	1200	15520	15700	16480	16080	+510	+500	+320	---	27	32	0,17
RO3 130			730	1300	16320	16500	17340	16920	+570	+500	+320	---	33	38	0,22
RO5 160	1600	800	730		15000	15220	16070	15800	+580	+510	+320	---	31	36	0,25
RO5 180	1800	900	730		16560	16810	17660	17600	+690	+520	+320	---	44	50	0,4
RO5 200	2000	1000	730		18360	18660	19640	19480	+820	+570	+320	---	45	50	0,41
RO6 14056V	1400	500/600	730		12970	13140	13850	13620	+300	+560	+320	+1160	22	27	0,16
RO6 14067V	1400	600/700	730		13580	13760	14550	14220	+340	+560	+320	+1160	25	30	0,2
RO6 14078V	1400	700/800	730		13760	13960	14740	14410	+350	+560	+320	+1160	28	33	0,22
RO6 14056H	1400	500/600	730		12970	13140	13850	13620	+300	+560	+320	+1160	22	27	0,16
RO6 14067H	1400	600/700	730		13580	13760	14550	14220	+340	+560	+320	+1160	25	30	0,2
RO6 14078H	1400	700/800	730		13760	13960	14740	14410	+350	+560	+320	+1160	48	33	0,22
RO6E 10050	930/1000	500	730		11660	11830	12450	12150	+240	+510	+320	---	19	24	0,15
RO6E 12060	1115/1200	600	730		11830	12000	12680	12380	+250	+510	+320	---	22	27	0,17
RO6E 14070	1300/1400	700	730		13280	13460	14250	13920	+340	+560	+320	---	28	33	0,22



Information

Artno	H = Höjd/ A = Uppfällld skiva	H = Höjd/ A = Uppfällld skiva	B	C	U		X
	H = Height/ A = Table top raised mm	H = Height/ A = Table top raised mm			Avstånd från golv till under- kant bordsskiva		
	H730	H900			H730	H900	
RO1 12050	730/995	900/1070	1120	475	710	880	540
RO1 12060	730/1045	900/1215	1120	475	710	880	540
RO1 12070	730/1095	900/1265	1120	575	710	880	640
RO1 14050	730/995	900/1070	1320	475	710	880	540
RO1 14060	730/1045	900/1215	1320	475	710	880	540
RO1 14070	730/1095	900/1265	1320	575	710	880	640
RO1 14080	730/1145	900/1315	1320	575	710	880	640
RO1 14090	730/1195	900/1365	1320	675	710	880	740
RO1 16080	730/1145	900/1315	1320	575	710	880	640
RO1 18050	730/995	900/1070	1720	475	710	880	540
RO1 18060	730/1045	900/1215	1720	475	710	880	540
RO1 18070	730/1095	900/1265	1720	575	710	880	640
RO1 18080	730/1145	900/1315	1720	575	710	880	640
RO1 18090	730/1195	900/1365	1720	675	710	880	740
RO1 200100	730/1245	900/1415	1720	675	710	880	740
RO1 220100	730/1245	900/1415	1720	675	710	880	740
RO3 120	730/1345	900/1515	740	675	710	880	740
RO3 130	730/1395	900/1565	920	675	710	880	740
RO5 160	730/1045	900/1215	920	475	710	880	540
RO5 180	730/1095	900/1265	1120	575	710	880	640
RO5 200	730/1095	900/1265	1320	575	710	880	640
RO6 14056V	730/1045	900/1215	1320	475	710	880	540
RO6 14067V	730/1095	900/1265	1320	475	710	880	540
RO6 14078V	730/1145	900/1265	1320	575	710	880	640
RO6 14056H	730/1045	900/1215	1320	475	710	880	540
RO6 14067H	730/1095	900/1265	1320	475	710	880	540
RO6 14078H	730/1145	900/1265	1320	575	710	880	640
RO6E 10050	730/995	900/1070	740	475	710	880	540
RO6E 12060	730/1045	900/1215	920	475	710	880	540
RO6E 14070	730/1095	900/1265	1120	575	710	880	640

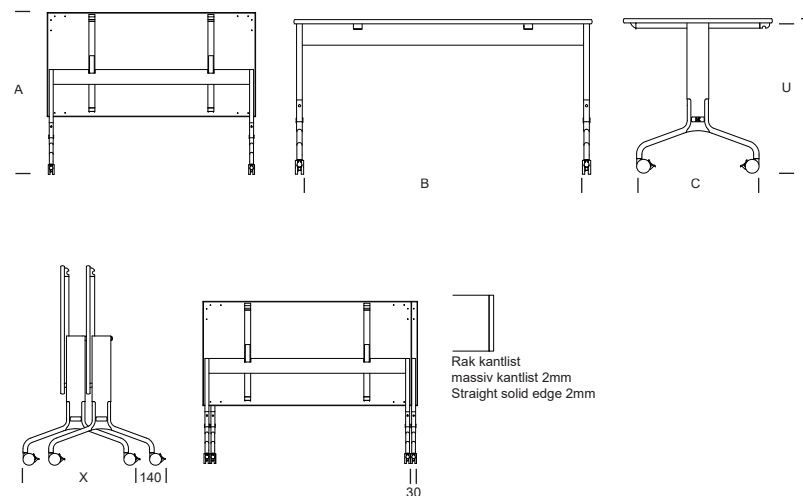

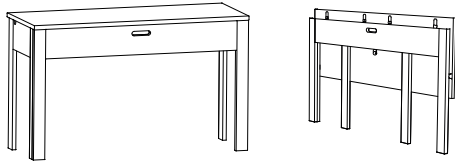

### Fällbord.

Bordsskivan och sargen av trälamell med faner i ek, björk, ask, standardbetser på ask och vitpigmenterad ek och ask. Alternativt högtryckslaminat ek, björk, ask, vit eller svart matt laminat och svart desktop. Ben i massivt trä av ek, björk och ask. Borden kan kopplas samman på kort- och långsida med hjälp av elastiska band som är standard. Bordet är 66mm ihopfällt. Bordet levereras monterat.

### Folding table.

The tabletop and rim are made of blockboard with veneers in oak, birch, ash, standard stain on ash and white glazed on oak and ash. Table top is also available in High Pressure Laminate of oak, birch, ash, white or black matte laminate and black desktop. The legs are made of solid wood in oak, birch and ash. The tables can be linked together with the help of elastic straps that are standard. The table is 66mm when it folded. The table comes pre-assembled.

### Artno

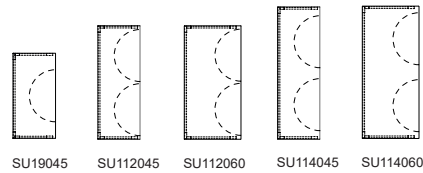

### Tillbehör Accessories



### PRV

**Vagn.** Låsbara hjul. Handtag monteras på långsida. Plats för 8 bord.  
**Trolley.** Lockable castors. Handle mounted on long side. Number of tables 8 pcs.

Study SEK								Extra SEK						
Artno	Längd Length mm	Bredd Width mm	Höjd Height mm	Top Faner Veneer Ben Legs .10 ek oak .20 björk birch .30 ask ash	Top Vit White Laminate Ben Legs .61 ek oak .62 björk birch .63 ask ash	Top Svart Black Laminate Ben Legs .65 ek oak .66 björk birch .67 ask ash  Top laminate Ben Legs .71 ek oak .72 björk birch .73 ask ash	Top Svart Black Desktop Ben Legs .91 ek oak .92 björk birch .93 ask ash	Standardbets på ask Standard stain on ash  Vitpigment ek ask White glazed oak ash	Avstånd mellan ben Distance between legs mm	Ihopfällt Folding mm	Vikt netto Weight net kilos	Vikt brutto Weight gross kilos	Volym Volume	
SU19045	900	450	725	8350	8420	9020	8650	+1250	853	66	13	19	0,07	
SU112045	1200	450	725	8800	8980	9620	9310	+1330	1152	66	14	20	0,1	
SU112060	1200	600	725	9190	9370	10080	9740	+1370	1152	66	16	26	0,12	
SU114045	1400	450	725	9340	9510	10260	9990	+1390	1352	66	15	21	0,11	
SU114060	1400	600	725	9790	10000	10760	10480	+1460	1352	66	18	24	0,14	
				<b>Tillbehör Accessories SEK</b>										
PRV vagn trolley	1200	740	1057	7460								30	1,1	

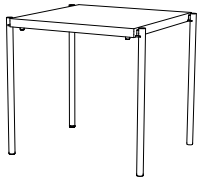

Bord Table

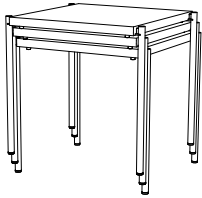

Bord staplingsbart upp till 5st  
Table stackable up to 5 pcs

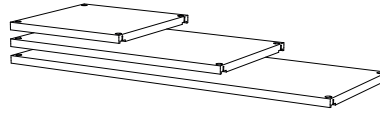

Kopplingskiva Connecting table top

### Bord stapelbart och kopplingskivor.

Bordsskivor och kopplingskivor tillverkas i en ramkonstruktion med toppskiva av faner i ek, björk, ask, standardbetser på ask och vitpigmenterad ek och ask. Alternativt högtryckslaminat ek, björk, ask, vit eller svart matt laminat och svart desktop. Vid laminat eller desktop välj kantlist av trä, vit eller svart plast. På undersidan sitter det en ljudabsorberande skiva med kläm- och stapelskydd. Borden är staplingsbara. Ben i vit (RAL9016 G130) eller svart (RAL9017 G130) pulverlackerat stål med filttass. Kopplingskivor kan förvaras på vagn eller hängas upp på vägg. Borden levereras omonterat. Benen skruvas fast under bordsskivan.

### Table stackable and connection table top.

All tabletops and connecting tabletops are made of framed construction with tops in veneers of oak, birch, ash, standard stain on ash and white glazed on oak and ash. Table top is also available in High Pressure Laminate of oak, birch, ash, white or black matte laminate and black desktop. Choose edge of wood, white or black plastic when table top is made of laminate or desktop. The underside of each table and connecting tabletops included a sound-absorbent pad, stacking and safety cover. The tables are stackable and the legs come in white (RAL9016 G130) or black powder (RAL9017 G130) coated steel, included felt floor protection. Store connecting tabletops on a trolley or hang them on the wall. The table comes unmounted. The legs are screwed under the table top.

### Artno bord table

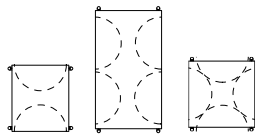

KC16070 KC112570 KC270

### Kopplingskiva Connection table top

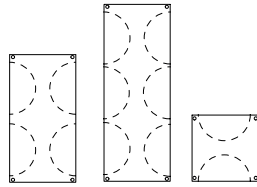

KC112570H KC118570H KC270H

### Tillbehör Accessories

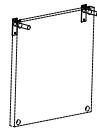

**KCK2s**  
Upphågningsbeslag på vägg.  
Svart metall. 2 kopplingskivor.

**Suspension bracket on wall.**  
Black metal. 2 connecting tabletops.



Kortsida Shortside



Längsida Longside

### PRV

#### Vagn för kopplingskivor.

Låsbara hjul. Handtag monteras på långsida eller kortsida.

**Trolley for connecting table tops.**  
Lockable castors. Handle mounted on long side or short side.

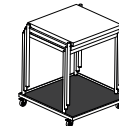

### KCV70

Vagn för bord 700x700 eller 700x600. Låsbara hjul, gummimatta. För 5 bord.

**Trolley for table 700x700 or 700x600.** Lockable castors, rubber carpet. For 5 tables.

### Kanecct SEK

### Extra SEK

Artno	Längd Length mm	Längd inkl ben Length incl. legs mm	Bredd Width mm	Höjd Height mm	Top Faner Veneer .10 ek oak .20 björk birch .30 ask ash .60 vit white laminate	.61 Top Svart black Laminat Top Laminat .71 ek oak .72 björk birch .73 ask ash	.90 Top Svart black Desktop	Standardbets på ask Standard stain on ash	Vikt netto Weight net kilos	Vikt brutto Weight gross kilos	Volym Volume
KC16070	600	684	700	725	8350	9020	8650	+750	12	19	0,1
KC112570	1250	1334	700	725	9690	10600	10260	+1080	17	24	0,2
KC270	700	784	700	725	8510	9210	10010	+880	13	20	0,11
KC112570H	1250		700		6870	7760	7440	+1080	11	18	0,02
KC118570H	1850		700		8190	9280	9040	+1280	16	23	0,02
KC270H	700		700		5660	6350	5980	+880	7	14	0,01
					<b>Tillbehör Accessories SEK</b>						
KCK2s upph.beslag suspen.bracket					820/2pcs						
PRV vagn upph.skiva troelly connect	1200		740	1057	7460					30	1,1
KCV70 vagn för bord troelly for tables	830		830	140	5040					20	0,2

# CAP BORD TABLE Roger Persson 2014

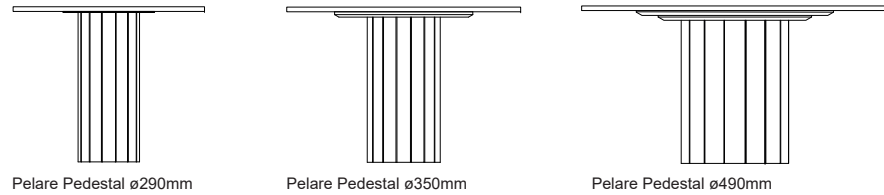

Pelare Pedestal ø290mm

Pelare Pedestal ø350mm

Pelare Pedestal ø490mm

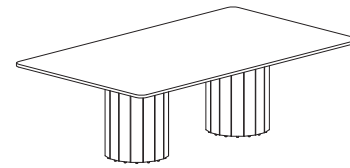

Rektulär Rectangulare

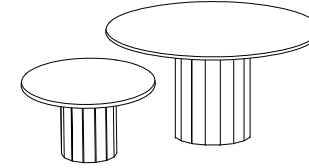

Rund Round

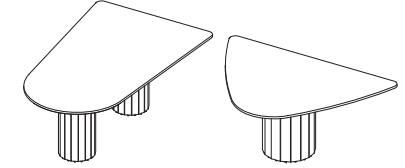

Oregelbunden form Irregular shape

## Pelarbord.

Pelare i massiv trä. Skivan, tjocklek 22mm, kan väljas mellan faner och vissa storlekar i massivt trä. Träslag är ek, björk, ask, standardfärger, standardbetsar på ask och vitpigmenterad ek och ask. Alternativt högtryckslaminat (ek, björk, ask, vit, svart) samt svart desktop. Vid val av betsfärg rekommenderas skivan i faner. Special mått och andra utförande efter förfrågan. Stabilitet och balans uppnås genom rätt mängd av stenmjöl i pelaren, beroenden på bordskivans storlek.

Bordet levereras ommonterat. Pelaren skruvas fast under bordsskivan. Vid order ange höjd och utförande.

## Pedestal table.

Pedestal in solid wood. Tabletop, thickness 22mm, in a choice of veneer or some dimensions in solid wood. Table come in oak, birch, ash, standard colors, standard stain on ash and white glazed on oak and ash. Table top is also available in High Pressure Laminate (oak, birch, ash, white, black) and black desktop. For stained finishes, we recommend a veneered top. Please enquire for details of non-standard sizes and other finishes.

The stability and balance of the construction is achieved by adding just the right amount of stone dust inside the pillar, according to the size of the tabletop. The table comes unmounted. The pedestal screwed under the table top. When ordering state height.

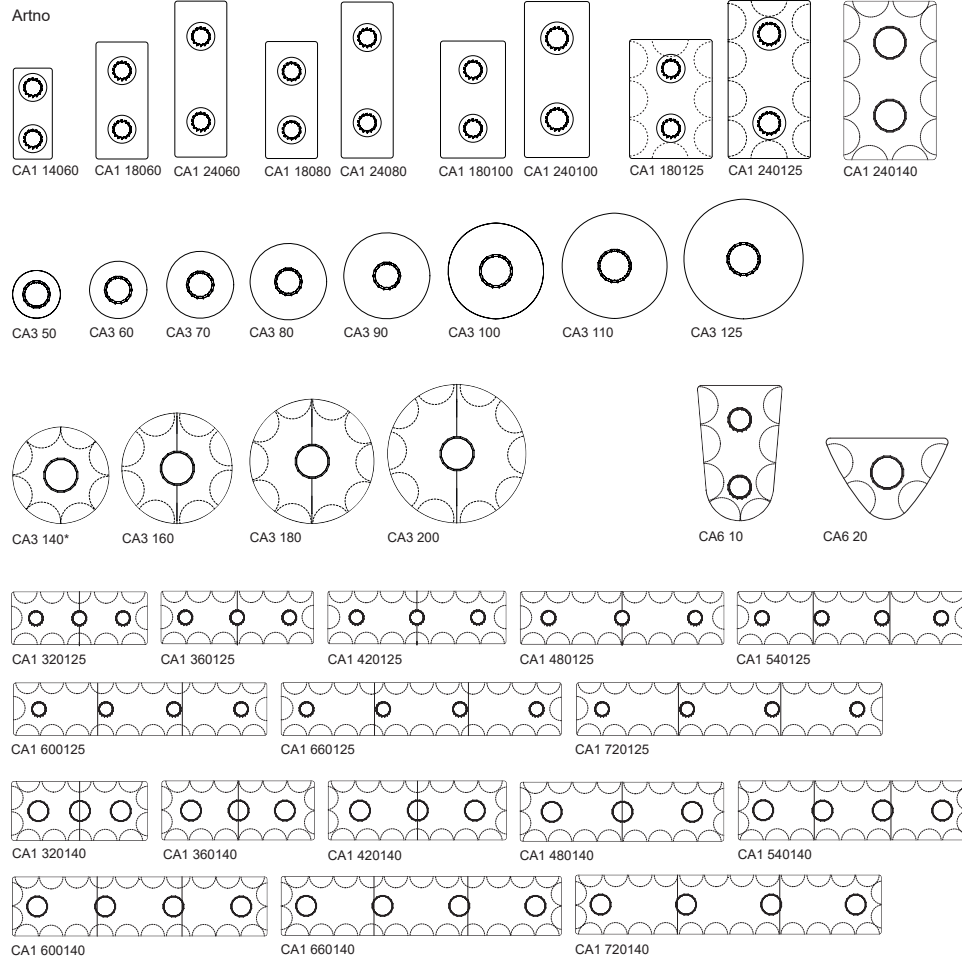

Tillbehör Accessories	Artno	Diam mm		SEK
	TKB7C	ø115	<b>Twist. Lock borstat rostfritt stål. 2 Eluttag. Kan endast placeras i skiva ovanför pelare. Lock borstat rostfritt stål. 2m kabel. Gäller för SE, NO, DK, FIN, DE, NL.</b> Twist. Brushed stainless lid. 2 Electrical. Placed only on table top above pedestal. 2m cables. For SE, NO, DK, FIN, DE, NL.	3550
	TKB11C	ø57	<b>Powerdot Mini. Placeras i skiva ovanför pelare alternativt i pelare lika illustration. 1 eluttag, svart, 1,5m kabel. Gäller för SE,NO,DK,FIN,DE,NL.</b> Powerdot Mini. Placed on top above pedestal alternative in the pedestal as the illustration. 1electrical black, 1,5m cable. For SE,NO,DK,FIN,DE,NL	1920
	TKB12C	ø57	<b>Powerdot Mini. Placeras i skiva ovanför pelare alternativt i pelare lika illustration. USB A laddare inkl. 2 portar, svart, 1,5m kabel. Gäller för SE,NO,DK,FIN,DE,NL.</b> Powerdot Mini. Placed on top above pedestal alternative in the pedestal as the illustration. USB A charging incl. 2 ports, black. 1,5m cable. For SE,NO,DK,FIN,DE,NL	2280
	TKB19C	ø57	<b>Powerdot Mini. Placeras i skiva ovanför pelare alternativt i pelare lika illustration. USB C laddare inkl. 2 portar, svart, 1,25m kabel. Gäller för SE,NO,DK,FIN,DE,NL.</b> Powerdot Mini. Placed on top above pedestal alternative in the pedestal as the illustration. USB C charging incl. 2 ports, black. 1,25m cable. For SE,NO,DK,FIN,DE,NL	2560
	TKB20C	ø70	<b>Powerdot Midi. Kan endast placeras i skiva ovanför pelare. 1 eluttag, 1 USB C laddare, svart, 1,25m kabel. Gäller för SE,NO,DK,FIN,DE,NL.</b> Powerdot Midi. Placed only on table top above pedestal. 1 electrical, 1 USB C charging, black. 1,25m cable. For SE,NO,DK,FIN,DE,NL	2560
	TKB15C	ø160 D 105	<b>Kabelgenomföring med elbrunn. Lösa lock. Exkl. eluttag. Placeras i skiva ovanför pelare ø350mm.</b> Cable slot with box. For socket and leads. Loose covers. Excl. electrical equipment. Placed on top above pedestal ø350mm.	3780
	TKB16C	ø270 D 105	<b>Kabelgenomföring med elbrunn. Lösa lock. Exkl. eluttag. Placeras i skiva ovanför pelare ø490mm</b> Cable slot with box. For socket and leads. Loose covers. Excl. electrical equipment. Placed on top above pedestal ø490mm.	3780

\* ek, björk, ask laminat = delad skiva  
\* oak, birch, ash laminate = divided top

## Cap Bord Table SEK

## Extra SEK

Artno	Längd Length mm	Bredd Width mm	Höjd Height mm	Diam på pelare Diam on pedestal mm	Top Faner Veneer Pelare Pedestal .10 ek oak .20 björk birch .30 ask ash .50 lack color	Top Vit White Laminat Pelare Pedestal .61 ek oak .62 björk birch .63 ask ash	Top Svart Black Laminat Pelare Pedestal .65 ek oak .66 björk birch .67 ask ash  Top Laminat Pelare Pedestal .71 ek oak .72 björk birch .73 ask ash	Top Svart Black Desktop Pelare Pedestal .91 ek oak .92 björk birch .93 ask ash	Standardbets på ask skiva Standard stain on ash top  Vitpigment ek ask White glazed oak ash	Standardbets på ask pelare Standard stain on ash pedestal  Vitpigment ek ask White glazed oak ash	Massiv skiva, klarlack Solid top, clear lacquer	Vikt netto Weight net kilos	Vikt brutto Weight gross kilos	Volym Volume
CA1 14060	1400	600	400,460,550	290	16110	16240	16760	16630	+510	+1100	+2030	106/106/108	138	1,54
CA1 14060	1400	600	730	290	20410	20540	21060	20930	+510	+1530	+2030	128	170	1,54
CA1 14060	1400	600	900,1100	290	22930	23060	23580	23450	+510	+1790	+2030	156/166	210	1,54
CA1 18060	1800	600	400,460,550	290	16930	17080	17680	17530	+590	+1100	+2360	120/120/122	152	1,92
CA1 18060	1800	600	730	290	21230	21380	21980	21830	+590	+1530	+2360	142	182	1,92
CA1 18060	1800	600	900,1100	290	23750	23900	24500	24350	+590	+1790	+2360	170/194	234	1,92
CA1 24060	2400	600	730	290	23190	23390	24190	23990	+790	+1530	+3930	156	196	1,92
CA1 24060	2400	600	900,1100	290	25710	25910	26710	26510	+790	+1790	+3930	186/208	248	1,92
CA1 18080	1800	800	730	290	23190	23390	24190	23990	+790	+1530	+3930	184	224	1,92
CA1 18080	1800	800	900,1100	290	25710	25910	26710	26510	+790	+1790	+3930	142/164	195	1,92
CA1 24080	2400	800	730	290	24580	24820	25780	25540	+920	+1530	+4620	224	264	1,92
CA1 24080	2400	800	900,1100	290	27100	27340	28300	28060	+920	+1790	+4620	198/220	260	1,92
CA1 180100	1800	1000	730	350	27240	27460	28340	28120	+870	+1860	+4330	198	238	1,92
CA1 180100	1800	1000	900,1100	350	30440	30660	31540	31320	+870	+2180	+4330	153/175	210	1,92
CA1 240100	2400	1000	730	350	30120	30410	31570	31280	+1150	+1860	+5770	234	280	2,30
CA1 240100	2400	1000	900,1100	350	33320	33610	34770	34480	+1150	+2180	+5770	218/240	275	2,30
CA1 180125	1800	1250	730	350	30840	31150	32390	32080	+1230	+1860		214	255	2,08
CA1 180125	1800	1250	900,1100	350	34040	34350	35590	35280	+1230	+2180		163/185	220	2,08
CA1 240125	2400	1250	730	350	33010	33380	34860	34490	+1440	+1860		254	295	3,0
CA1 240125	2400	1250	900,1100	350	36210	36580	38060	37690	+1440	+2180		233/255	300	3,0
CA1 240140	2400	1400	730	490	46170	46680	48720	48210	+2030	+2280		370	400	3,2
CA1 240140	2400	1400	900,1100	490	49250	49760	51800	51920	+2030	+2590		390/400	430/450	3,2
CA1 320125	3200	1250	730	350	47990	48500	50540	50030	+2010	+2790		310	350	1,85
CA1 320125	3200	1250	900,1100	350	52790	53300	55340	54830	+2010	+3270		320/340	360/380	1,85
CA1 360125	3600	1250	730	350	53280	53920	56480	55840	+2540	+2790		350	390	2,32
CA1 360125	3600	1250	900,1100	350	58080	58720	61280	60640	+2540	+3270		360/380	400/420	2,32
CA1 420125	4200	1250	730	350	60460	61280	64560	63740	+3260	+2790		408	450	2,55
CA1 420125	4200	1250	900,1100	350	65260	66080	69360	68540	+3260	+3270		420/450	460/490	2,55
CA1 480125	4800	1250	730	350	64990	65920	69640	68710	+3710	+2790		440	480	2,9
CA1 480125	4800	1250	900,1100	350	69790	70720	74440	73510	+3710	+3270		450/470	480/520	2,9

Artno	Längd Length mm	Bredd Width mm	Höjd Height mm	Diam på pelare Diam on pedestal mm	Cap Bord Table SEK				Extra SEK		Vikt netto Weight net kilos	Vikt brutto Weight gross kilos	Volym Volume
					Top Faner Veneer Pelare Pedestal .10 ek oak .20 björk birch .30 ask ash .50 lack color	Top Vit White Laminate Pelare Pedestal .61 ek oak .62 björk birch .63 ask ash	Top Svart Black Laminate Pelare Pedestal .65 ek oak .66 björk birch .67 ask ash  Top Laminate Pelare Pedestal .71 ek oak .72 björk birch .73 ask ash	Top Svart Black Desktop Pelare Pedestal .91 ek oak .92 björk birch .93 ask ash	Standardbets på ask skiva Standard stain on ash top  Vitpigment ek ask White glazed oak ash	Standardbets på ask pelare Standard stain on ash pedestal  Vitpigment ek ask White glazed oak ash			
CA1 540125	5400	1250	730	350	75710	76680	80560	79590	+3860	+3720	540	580	2,32
CA1 540125	5400	1250	900,1100	350	82110	83080	86960	85990	+3860	+4360	550/570	590/620	2,32
CA1 600125	6000	1250	730	350	79800	80870	85150	84080	+4260	+3720	580	620	1,86
CA1 600125	6000	1250	900,1100	350	86200	87270	91550	90480	+4260	+4360	590/610	640/650	1,86
CA1 660125	6600	1250	730	350	88750	90040	95200	93910	+5160	+3720	610	660/680	2,03
CA1 660125	6600	1250	900,1100	350	95150	96440	101600	100310	+5160	+4360	620/640	660/690	2,03
CA1 720125	7200	1250	730	350	93280	94690	100330	98920	+5610	+3720	650	690	2,32
CA1 720125	7200	1250	900,1100	350	99680	101090	106730	105320	+5610	+4360	660/680	700/740	2,32
CA1 320140	3200	1400	730	490	64120	64760	67320	66680	+2530	+3420	320	360	2,05
CA1 320140	3200	1400	900,1000	490	68740	69380	71940	71300	+2530	+3880	330/350	370/390	2,05
CA1 360140	3600	1400	730	490	70140	70930	74090	73300	+3130	+3420	384	420	2,56
CA1 360140	3600	1400	900,1000	490	74760	75550	78710	77920	+3130	+3880	400/420	440/460	2,56
CA1 420140	4200	1400	730	490	75220	76130	79770	78860	+3640	+3420	448	490	2,05
CA1 420140	4200	1400	900,1000	490	79840	80750	84390	83480	+3640	+3880	460/480	490/520	2,05
CA1 480140	4800	1400	730	490	80290	81330	85490	84450	+4150	+3420	510	550	2,18
CA1 480140	4800	1400	900,1000	490	84910	85950	90110	89070	+4150	+3880	520/550	560/590	2,18
CA1 540140	5400	1400	730	490	94720	95800	100120	99040	+4300	+4560	670	720	2,56
CA1 540140	5400	1400	900,1000	490	100880	101960	106280	105200	+4300	+5180	680/720	730/770	2,56
CA1 600140	6000	1400	730	490	104260	105580	110860	109540	+5250	+4560	744	800	2,70
CA1 600140	6000	1400	900,1000	490	110420	111740	117020	115700	+5250	+5180	760/790	810/860	2,70
CA1 660140	6600	1400	730	490	109330	110770	116530	115090	+5760	+4560	818	870	3,07
CA1 660140	6600	1400	900,1000	490	115490	116930	122690	121250	+5760	+5180	830/850	880/910	3,07
CA1 720140	7200	1400	730	490	114400	115970	122250	120680	+6260	+4560	890	950	3,6
CA1 720140	7200	1400	900,1000	490	120560	123700	128410	126840	+6260	+5180	900/950	960/1000	3,6
<b>Oregelbunden form Irregular shape</b>													
CA6 10	2000	1250	730	350	33310	33660	35060	34710	+1360	+1860	254	295	3,0
CA6 20	1200	1800	730	490	22810	23040	23960	23730	+910	+1140	168	193	1,32

# CAP BORD TABLE Roger Persson 2014



## Cap Bord Table SEK

## Extra SEK

Artno	Diam mm	Höjd Height mm	Diam på pelare Diam on pedestal mm	Top Faner Veneer Pelare Pedestal .10 ek oak .20 björk birch .30 ask ash .50 lack color	Top Vit White Laminate Pelare Pedestal .61 ek oak .62 björk birch .63 ask ash	Top Svart Black Laminate Pelare Pedestal .65 ek oak .66 björk birch .67 ask ash  Top Laminate Pelare Pedestal .71 ek oak .72 björk birch .73 ask ash	Top Svart Black Desktop Pelare Pedestal .91 ek oak .92 björk birch .93 ask ash	Standardbets på ask skiva Standard stain on ash top  Vitpigment ek ask White glazed oak ash	Standardbets på ask pelare Standard stain on ash pedestal  Vitpigment ek ask White glazed oak ash	Massiv skiva, klarlack Solid top, clear lacquer	Vikt netto Weight net kilos	Vikt brutto Weight gross kilos	Volym Volume
<b>Rund Round</b>													
CA3 50	ø500	400,460,550	290	7950	8020	8300	8230	+240	+550	+970	38/38/39	73/73/74	0,1
CA3 50	ø500	730	290	10100	10170	10450	10380	+240	+770	+970	50	85	0,13
CA3 50	ø500	900,1100	290	11360	11430	11710	11640	+240	+890	+970	64/80	100/115	0,2
CA3 60	ø600	400,460,550	290	8480	8560	8880	8800	+300	+550	+1180	45/45/46	80/80/81	0,1
CA3 60	ø600	730	290	10630	10710	11030	10950	+300	+770	+1180	52	87	0,13
CA3 60	ø600	900,1100	290	11890	11970	12290	12210	+300	+890	+1180	66/83	101/118	0,2
CA3 70	ø700	400,460,550	290	8860	8950	9310	9220	+330	+550	+1340	47/52/53	82/87/88	0,1
CA3 70	ø700	730	290	11010	11100	11460	11370	+330	+770	+1340	64	99	0,13
CA3 70	ø700	900,1100	290	12270	12360	12720	12630	+330	+890	+1340	78/89	113/124	0,2
CA3 80	ø800	400,460,550	290	9880	9990	10430	10320	+440	+550	+1740	48/56/58	83/91/93	0,11
CA3 80	ø800	730	290	12030	12140	12580	12470	+440	+770	+1740	66	101	0,13
CA3 80	ø800	900,1100	290	13290	13400	13840	13730	+440	+890	+1740	84/96	119/131	0,17
CA3 90	ø900	460,550	350	12320	12440	12920	12800	+470	+770	+2100	58/66/68	85/93/95	0,14
CA3 90	ø900	730	290	12340	12460	12940	12820	+470	+770	+2100	68	103	0,16
CA3 90	ø900	900,1100	290	13600	13720	14200	14080	+470	+890	+2100	84/96	119/131	0,18
CA3 100	ø1000	460,550	350	13420	13570	14170	14020	+580	+770	+2600	78/80	108/110	0,19
CA3 100	ø1000	730	350	15060	15210	15810	15660	+580	+930	+2600	90	125	0,21
CA3 100	ø1000	900,1100	350	16660	16810	17410	17260	+580	+1090	+2600	111/119	146/154	0,23
CA3 110	ø1100	400,460,550	490	15670	15820	16420	16270	+600	+990	+2620	71/83/85	105/112/115	1,25
CA3 110	ø1100	730	350	15110	15260	15860	15710	+600	+930	+2620	97	132	1,25
CA3 110	ø1100	900,1100	350	16710	16860	17460	17310	+600	+1090	+2620	111/127	146/162	1,25
CA3 125	ø1250	400,460,550	490	16980	17160	17880	17700	+710	+990	+3570	81/93/95	107/115/117	1,45
CA3 125	ø1250	730	350	16420	16600	17320	17140	+710	+930	+3570	119	154	1,45
CA3 125	ø1250	900,1100	350	18020	18200	18920	18740	+710	+1090	+3570	121/135	156/170	1,45
CA3 140*	ø1400	730	490	22370	22610	23570	23330	+940	+1140		142	160	1,21
CA3 140*	ø1400	900, 1100	490	23910	24150	25110	24870	+940	+1290		132/146	147/161	1,21
CA3 160	ø1600	730	490	27250	27580	28900	28570	+1320	+1140		148	170	1,32
CA3 160	ø1600	900, 1100	490	28790	29120	30440	30110	+1320	+1290		156/170	176/190	1,32
CA3 180	ø1800	730	490	31180	31600	33280	32860	+1650	+1140		168	193	1,32
CA3 180	ø1800	900, 1100	490	32720	33140	34820	34400	+1650	+1290		182/196	207/221	1,42
CA3 200	ø2000	730	490	36030	36540	38580	38070	+2010	+1140		194	224	1,42
CA3 200	ø2000	900, 1100	490	37570	38080	40120	39610	+2010	+1290		208/222	238/252	1,42

\* ek, björk, ask laminat = delad skiva  
\* oak, birch, ash laminate = divided top

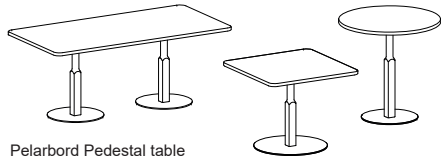

Pelarbord Pedestal table

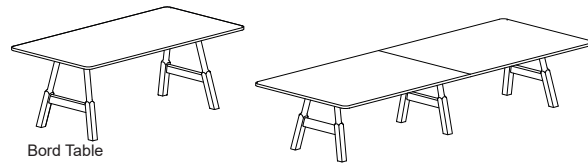

Bord Table

**Pelarbord.** Rektangulär, kvadratisk och rund skiva fanerad MDF, klarlack. Faner i ek, ask, standardbetser på ask och vitpigmenterad ek eller ask. Alternativt högtryckslaminat i vit, svart matt, ek, ask och svart desktop. Pelaren är i massiv trä med stälkärna. Fotplattan är i metall och pulverlack av vit (RAL 9016) svart (RAL 9005), grå (RAL 9006/07) och försedd med filtassar. Bordet levereras ommonterat. Skiva skruvas på pelare. Bordskivan, pelare och fotplatta är separerbara och enkla att fräscha upp efter många års användning. Som tillbehör till rektangulär bordsskiva (ej kvadratisk, rund) finns eluttag. Vid order ange artikelnummer, höjd och utförande av fotplatta.

**Bord.** Rektangulär skiva i fanerad trälamell, klarlack. Faner i ek, ask, standardbetser på ask och vitpigmenterad ek eller ask. Alternativt högtryckslaminat i vit, svart matt, ek, ask och svart desktop. Benstativet och sargen i massiv trä och försedd med ställfötter. Bordet levereras ommonterat. Bengavel, sargen och skiva skruvas samman. Som tillbehör till bordet finns olika eluttag. Vid order ange artikelnummer, höjd och utförande.

**Pedestal table.** Rectangular, square and round top, veneered MDF, clear lacquer. Veneer in oak, ash, standardstain on ash and white glazed oak or ash. Table top is also available in High Pressure Laminate of oak, ash, white or black matte and black desktop. The pedestal is in solid wood with a steel core. The table footplate is in metal, powder lacquered in white (RAL 9016), black (RAL 9005) or grey (RAL 9006/07) and has felt floor protectors. Table top, pedestal and footplate are detachable, so it is simple to freshen them up after many years' faithful service. Electrical outlets are available only for rectangular table top (not round and square) When ordering state article number, height, finish and finish of footplate.

**Table.** Rectangular table top veneered blockboard, clear lacquer. Veneer in oak, ash, standardstain on ash and white glazed oak or ash. Table top is also available in High Pressure Laminate of oak, ash, white or black matte laminate and black desktop. The underframe and legs are in solid wood with adjustment screws on the feet. The table is supplied unassembled. Various power outlets are available as optional extras. Please enquire for details of non-standard sizes and other finishes. When ordering state article number, height and finish.

Artno Pelarbord Pedestal table

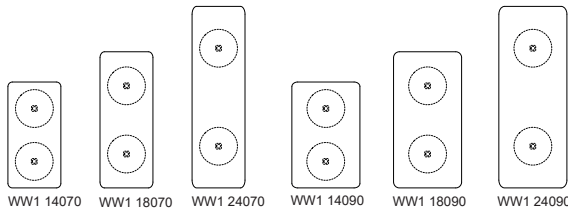

WW1 14070 WW1 18070 WW1 24070 WW1 14090 WW1 18090 WW1 24090

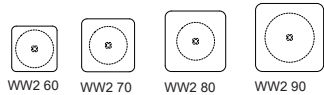

WW2 60 WW2 70 WW2 80 WW2 90

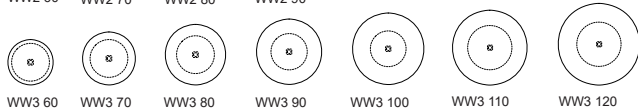

WW3 60 WW3 70 WW3 80 WW3 90 WW3 100 WW3 110 WW3 120

Artno Bord Table

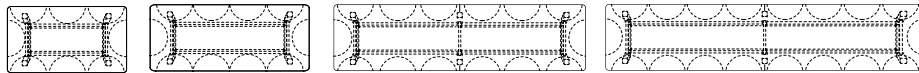

WW1 180100 WW1 240100 WW1 380100 WW1 480100

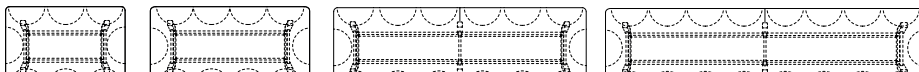

WW1 180120 WW1 240120 WW1 380120 WW1 480120

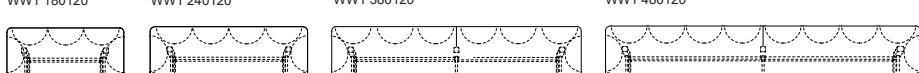

WW1 180140 WW1 240140 WW1 380140 WW1 480140

Tillbehör Accessories	Artno	Dimension		SEK
	TKB4WW	L282 B127 D130	<b>Kabelgenomföring med elbrunn, lösa lock. Svart MDF botten L750 TJ12mm, monteras centrerat under kabelgenomföringen. Exkl. eluttag. Endast för Bord.</b> Cable slot, for socket and leads. Loose covers. Black MDF bottom L750 and thickness 12mm placed centered under the cable slot. Excl. electrical equipment. Only for Table.	2920
	TKB14WW	L402 B127 D130	<b>Kabelgenomföring med elbrunn, lösa lock. Svart MDF botten L750 TJ12mm, monteras centrerat under kabelgenomföringen. Exkl. eluttag. Endast för Bord.</b> Cable slot, for socket and leads. Loose covers. Black MDF bottom L750 and thickness 12mm placed centered under the cable slot. Excl. electrical equipment. Only for Table.	2080
	TKB15WW	L600 B140 D130	<b>Acessline Duo60II från Kondator. Metall lock, färg svart, vit, silver. Svart MDF botten L750 TJ12mm, monteras centrerat under kabelgenomföringen. Exkl. eluttag. Endast för Bord.</b> Acessline Duo60II from Kondator. Metal lid col. black, white, silver. Black MDF bottom L750 and thickness 12mm placed centered under the cable slot. Excl. electrical equipment. Only for Table.	2190
	TKB7	ø115	<b>Twist. Lock borstat rostfritt stål. 2 Eluttag. 2m kabel. Gäller för SE, NO, DK, FIN, DE, NL. Endast för Rektangulära pelarbord och Bord.</b> Twist. Brushed stainless lid. 2 Electrical. 2m cables. For SE, NO, DK, FIN, DE, NL. Only for Rectangulare Pedestal table and Table	2440
	TKB11	ø57	<b>Powerdot Mini. 1 eluttag, svart, 1,5m kabel. Gäller för SE, NO, DK, FIN, DE, NL. Endast för Rektangulära Pelarbord och Bord.</b> Powerdot Mini. 1 electrical black, 1,5m cable. For SE, NO, DK, FIN, DE, NL. Only for rectangular Pedestal table and Table.	710
	TKB12	ø57	<b>Powerdot Mini. USB A laddare inkl. 2 portar, svart, 1,5m kabel. Gäller för SE, NO, DK, FIN, DE, NL. Endast för Rektangulära pelarbord och Bord.</b> Powerdot Mini. USB A charging incl. 2 ports, black, 1,5m cable. For SE, NO, DK, FIN, DE, NL. Only for rectangular Pedestal table and Table.	1070
	TKB19	ø57	<b>Powerdot Mini. USB C laddare inkl. 2 portar, svart, 1,25m kabel. Gäller för SE, NO, DK, FIN, DE, NL. Endast för Rektangulär pelarbord och Bord.</b> Powerdot Mini. USB C charging incl. 2 ports, black, 1,25m cable. For SE, NO, DK, FIN, DE, NL. Only for rectangular Pedestal table and Table.	1210
	TKB20	ø70	<b>Powerdot Midi. 1 eluttag, 1 USB C laddare, svart 1,25m kabel. Gäller för SE, NO, DK, FIN, DE, NL. Endast för Rektangulär pelarbord och Bord.</b> Powerdot Midi. 1 electrical, 1 USB C charging, black, 1,25m cable. For SE, NO, DK, FIN, DE, NL. Only for rectangular Pedestal table and Table.	1210



Artno	Längd Length mm	Bredd Width mm	Diam. mm	Höjd Height mm	Top Faner Veneer Pelare Pedestal .10 ek oak .30 ask ash	Top Vit White Laminate Pelare Pedestal .61 ek oak .63 ask ash	Top Svart Black Laminate Pelare Pedestal .71 ek oak .73 ask ash	Top Svart Black Desktop Pelare Pedestal .91 ek oak .93 ask ash	Standardbets på ask skiva Standard stain on ash top  Vitpigment ek ask White glazed oak ash	Standardbets på ask pelare/ben Standard stain on ash pedestal/legs  Vitpigment ek ask White pigment oak ash	Vikt brutto Weight gross kilos	Volym Volume
<b>PELARBORD PEDESTAL Rektangulär Rectangulare</b>												
WW1 14070	1400	700		730, 900, 1050	18550	18740	19550	19230	+1000	+1190	76	0,51/0,56/0,61
WW1 18070	1800	700		730, 900, 1050	20190	20410	21260	21040	+1250	+1190	84	0,53/0,58/0,63
WW1 24070	2400	700		730, 900, 1050	20720	20960	22450	21900	+1330	+1190	96	0,56/0,61/0,66
WW1 14090	1400	900		730, 900, 1050	19410	19610	20600	20110	+1130	+1190	84	0,53/0,58/0,63
WW1 18090	1800	900		730, 900, 1050	21200	21410	22470	22090	+1410	+1190	96	0,56/0,61/0,66
WW1 24090	2400	900		730	22840	23100	24610	24070	+1650	+1190	102	0,6/0,65/0,7
<b>Kvadratisk Square</b>												
WW2 60	600	600		730, 900, 1050	9600	9670	10110	9890	+550	+590	36	0,25/0,3/0,35
WW2 70	700	700		730, 900, 1050	10140	10230	10840	10470	+630	+590	38	0,26/0,31/0,36
WW2 80	800	800		730, 900, 1050	10610	10700	11380	10960	+700	+590	42	0,27/0,32/0,37
WW2 90	900	900		730	11880	11990	12760	12240	+780	+590	46	0,28/0,33/0,38
<b>Rund Round</b>												
WW3 60			ø600	730, 900, 1050	9250	9320	9760	9550	+500	+590	35	0,25/0,3/0,35
WW3 70			ø700	730, 900, 1050	9870	9930	10550	10180	+590	+590	36	0,26/0,31/0,36
WW3 80			ø800	730, 900, 1050	10260	10350	11030	10610	+650	+590	40	0,27/0,32/0,37
WW3 90			ø900	730, 900, 1050	10840	10940	11720	11190	+730	+590	43	0,28/0,33/0,38
WW3 100			ø1000	730, 900, 1050	11630	11770	12530	12010	+860	+590	47	0,29/0,34/0,39
WW3 110			ø1100	730	12890	13050	13820	13300	+930	+590	59/62/65	0,46/0,54/0,61
WW3 120			ø1200	730	13600	13740	14590	14030	+1050	+590	59/66/69	0,48/0,56/0,63
<b>BORD Rektangulär TABLE Rectangulare</b>												
WW1 180100	1800	1000		730, 900	27120	27380	28400	28140	+1360	+2710	71/75	0,31/0,35
WW1 240100	2400	1000		730, 900	30510	30830	33210	31780	+1530	+3050	115/119	0,36/0,4
WW1 380100	3800	1000		730, 900	49760	50270	52310	51800	+2490	+4980	178/184	0,56/0,46
WW1 480100	4800	1000		730, 900	57340	57990	60590	59940	+2870	+5730	218/224	0,65/0,71
WW1 180120	1800	1200		730, 900	28370	28650	29770	29490	+1420	+2840	81/85	0,33/0,37
WW1 240120	2400	1200		730, 900	33640	34020	35550	35170	+1680	+3360	105/109	0,38/0,42
WW1 380120	3800	1200		730, 900	54740	55350	57790	57180	+2740	+5470	168/174	0,58/0,48
WW1 480120	4800	1200		730, 900	67150	67990	71350	70510	+3360	+6710	208/214	0,67/0,73
WW1 180140	1800	1400		730, 900	32270	32620	----	33690	+1610	+3230	91/95	0,35/0,39
WW1 240140	2400	1400		730, 900	38830	39320	----	40770	+1940	+3880	117/121	0,38/0,42
WW1 380140	3800	1400		730, 900	59700	60420	----	62550	+2990	+5970	184/190	0,63/0,69
WW1 480140	4800	1400		730, 900	69910	70800	----	73470	+3490	+6990	228/234	0,66/0,79

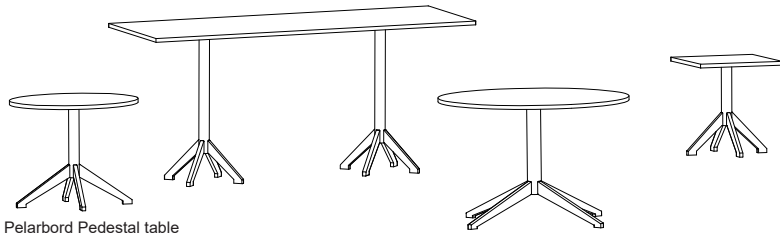

Pelarbord Pedestal table

**Pelarbord "Kryssfot".**

Rektangulär skiva = fanerad trälamell, klarlack.  
 Kvadratisk, rund och oval skiva = fanerad MDF, klarlack.  
 Faner i ek, björk, ask, standardfärger, standardbetser på ask eller vitpigmenterad ek och ask. Alternativt är högtryckslaminat ek, björk, ask, vit eller svart samt svart desktop. Specialmått och andra utförande efter förfrågan.  
 Pelare och fotkryssset, med en karaktäristisk klack nertill är i massivt trä med ställfötter. Bordet levereras omonterat. Pelaren skruvas fast under bordsskivan. Tillval endast till rektangulära bord är eluttag. Vid order ange utförande och höjd.

**Pedestal table "4-star base".**

Rectangulare top = veneered blockboard, clear lacquer.  
 Square, round and oval top = veneered MDF, clear lacquer.  
 Veneer in oak, birch, ash, standard colors, standard stains on ash or white glazed on oak or ash. Table top i also available in High Pressure Laminate of oak, birch, ash, white or black and black desktop.  
 Please enquire for details of non-standard sizes and finishes. The pedestal and feet with characteristic heels at the bottom are in solid wood with adjustable screws. The table comes unmounted. The pedestal screwed under the table top. When ordering state finish and height.

Artno Pelarbord Pedestal table

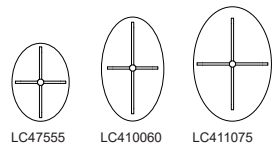
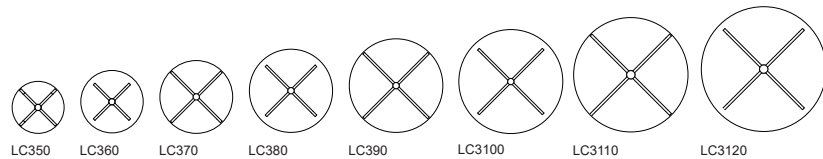
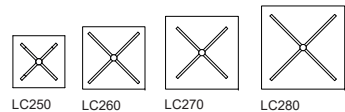
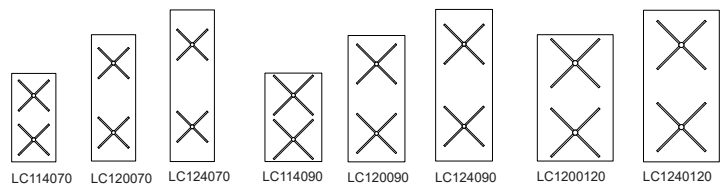

Tillbehör Accessories	Artno	Diam mm		SEK
	TKB4		<b>Kabelgenomföring med elbrunn, svart. Ett löst lock. Exkl. eluttag. Endast för Rektangulära pelarbord.</b> Cable slot with box, black. For socket and leads. One loose covers. Excl. electrical equipment. Only for rectangular Pedestal table.	2920
	TKB7	ø115	<b>Twist. Lock borstat rostfritt stål. 2 Eluttag. 2m kabel. Gäller för SE, NO, DK, FIN, DE, NL. Endast för Rektangulära pelarbord.</b> Twist. Brushed stainless lid. 2 Electrical. 2m cables. For SE, NO, DK, FIN, DE, NL. Only for rectangular Pedestal table.	2440
	TKB11	ø57	<b>Powerdot Mini. 1 eluttag, svart, 1,5m kabel. Gäller för SE,NO,DK,FIN,DE,NL. Endast för Rektangulära pelarbord.</b> Powerdot Mini. 1electrical black, 1,5m cable. For SE,NO,DK,FIN,DE,NL. Only for rectangular Pedestal table.	710
	TKB12	ø57	<b>Powerdot Mini. USB A laddare inkl. 2 portar, svart, 1,5m kabel. Gäller för SE,NO,DK,FIN,DE,NL. Endast för Rektangulära pelarbord.</b> Powerdot Mini. USB A charging incl. 2 ports, black, 1,5m cable. For SE,NO,DK,FIN,-DE,NL. Only for rectangular Pedestal table.	1070
	TKB19	ø57	<b>Powerdot Mini. USB C laddare inkl. 2 portar, svart, 1,25m kabel. Gäller för SE,NO,DK,FIN,DE,NL. Endast för Rektangulära pelarbord.</b> Powerdot Mini. USB C charging incl. 2 ports, black, 1,25m cable. For SE,NO,DK,-FIN,DE,NL. Only for rectangular Pedestal table.	1210
	TKB20	ø70	<b>Powerdot Midi. 1 eluttag, 1 USB C laddare, svart 1,25m kabel. Gäller för SE,NO,DK,FIN,DE,NL. Endast för Rektangulära pelarbord.</b> Powerdot Midi. 1 electrical, 1 USB C charging, black, 1,25m cable. For SE,NO,DK,-FIN,DE,NL. Only for rectangular Pedestal table.	1210

Artno	Längd Length mm	Bredd Width mm	Diam. mm	Höjd Height mm	Locus SEK					Extra SEK		
					Top Faner Veneer .10 ek oak .20 björk birch .30 ask ash	.50 Top Lack Color	Top Vit White Laminate Pelare Fot Pedestal Foot .61 ek oak .62 björk birch .63 ask ash	Top Svart Black Laminate Pelare Fot Pedestal Foot .65 ek oak .66 björk birch .67 ask ash	Top Svart Black Desktop Pelare Fot Pedesta Foot .91 ek oak .92 björk birch .93 ask ash	Standardbets på ask Standard stain on ash  Vitpigment ek ask White glazed oak ash	Vikt brutto Weight gross kilos	Volym Volume
<b>PELARBORD PEDESTAL</b> Rektangulär Rectangulare												
LC114070	1400	700		550,620,730,900,1100	19850	17150	20030	20850	20520	+2980	34	0,3/0,36/0,4/0,5/0,6
LC120070	2000	700		550,620,730,900,1100	21710	17870	21940	23030	22820	+3240	40	0,3/0,36/0,4/0,5/0,6
LC124070	2400	700		550,620,730,900,1100	22760	18930	22990	24490	23930	+3410	45	0,3/0,36/0,4/0,5/0,6
LC114090	1400	900		550,620,730,900,1100	20900	17550	21170	22680	22120	+3130	37	0,5/0,6/0,7/0,84/1,0
LC120090	2000	900		550,620,730,900,1100	23570	18470	23830	25130	24540	+3540	43	0,5/0,6/0,7/0,84/1,0
LC124090	2400	900		550,620,730,900,1100	26710	19410	26980	28490	27930	+4000	47	0,5/0,6/0,7/0,84/1,0
LC1200120	2000	1200		730	30640	22410	30970	32350	31720	+4600	51	1,0
LC1240120	2400	1200		730	36200	23280	36620	38220	37530	+5440	55	1,0
<b>Kvadratisk Square</b>												
LC250	500	500		550,620,730,900,1100	8970	7980	9020	9480	9250	+1350	10	0,09/0,1/0,12/0,15/0,18
LC260	600	600		550,620,730,900,1100	9770	8380	9850	10280	10080	+1460	15	0,15/0,18/0,2/0,25/0,3
LC270	700	700		550,620,730,900,1100	11010	8510	11090	11710	11340	+1650	17	0,15/0,18/0,2/0,25/0,3
LC280	800	800		550,620,730,900,1100	11410	8940	11490	12190	11760	+1710	19	0,26/0,3/0,34/0,42/0,5
<b>Rund Round</b>												
LC350			ø500	550,620,730,900,1100	8600	7890	8650	9110	8880	+1300	10	0,09/0,1/0,12/0,15/0,18
LC360			ø600	550,620,730,900,1100	9150	8100	9210	9660	9420	+1360	15	0,15/0,18/0,2/0,25/0,3
LC370			ø700	550,620,730,900,1100	10370	8450	10460	11070	10700	+1570	17	0,15/0,18/0,2/0,25/0,3
LC380			ø800	550,620,730,900,1100	10700	8820	10780	11470	11030	+1620	19	0,26/0,3/0,34/0,42/0,5
LC390			ø900	550,620,730,900,1100	11070	9210	11160	11950	11420	+1670	21	0,26/0,3/0,34/0,42/0,5
LC3100			ø1000	550,620,730,900,1100	12180	9680	12310	13070	12560	+1830	23	0,26/0,3/0,34/0,42/0,5
LC3110			ø1100	730	13440	11340	13570	14350	13840	+2010	25	0,5
LC3120			ø1200	730	14530	11680	14680	15530	14960	+2180	27	0,5
<b>Oval</b>												
LC47555	750	550		550,620,730,900,1100	9660	8320	9740	10430	10000	+1440	12	0,2/0,23/0,26/0,4/0,48
LC410060	1000	600		550,620,730,900,1100	10370	8870	10500	11270	10750	+1570	15	0,26/0,29/0,34/0,42/0,5
LC411075	1100	750		550,620,730,900,1100	11130	9290	11280	12050	11540	+1670	18	0,37/0,4/0,48/0,6/0,71

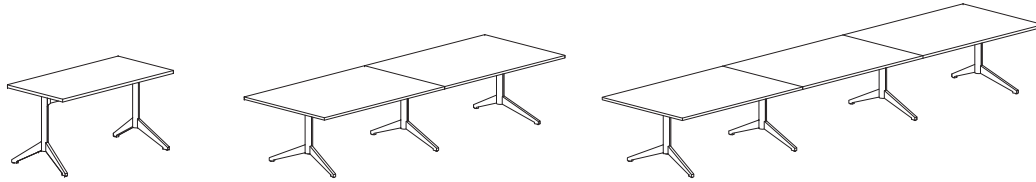

### Bord "T-stativ".

Rektangulär skiva = fanerad trälamell, klarlack. Faner i ek, björk, ask, standardbetser på ask eller vitpigmenterad ek och ask. Alternativt är högtryckslaminat (ek, björk, ask, vit, svart) samt svart desktop. Specialmått och andra utförande efter förfrågan. Tillval är eluttag där kabel förs genom pelaren och ner till golvet.  
Pelare och fot, med en karaktäristisk klack nertill är i massivt trä med ställfötter. Bordet levereras omonterat. Pelaren skruvas fast under bordsskivan. Vid behov kan bordsskiva och ben enkelt demonteras med enkla handverktyg. Vid order ange utförande.

### Table "T-base".

Rectangular top = veneered blockboard, clear lacquer. Veneer in oak, birch, ash, standard stains on ash or white glazed on oak or ash. Table top is also available in High Pressure Laminate of oak, birch, ash, white or black laminate and black desktop. An option is an electrical outlet where the cable is pulled through the column and down to the floor. Please enquire for details of non-standard sizes and finishes. The pedestal and feet with characteristic heels at the bottom are in solid wood with adjustable screws. The table comes unmounted. The pedestal screwed under the table top. The tabletop and leg can easily be dismantled with hand tools. When ordering state article number and finish.

### Artno Bord Table

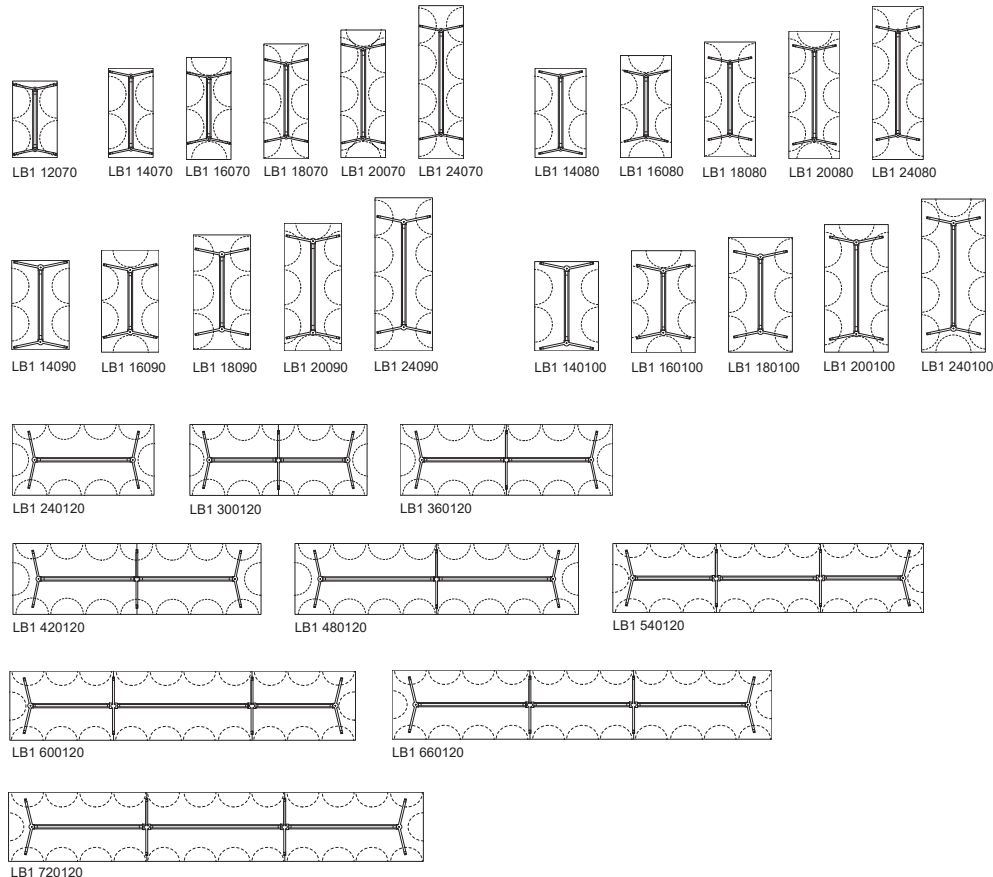

Tillbehör Accessories	Artno	Diam mm		SEK
	TKB7	ø115	<b>Twist. Lock borstat rostfritt stål. 2 Eluttag. 2m kabel. Gäller för SE, NO, DK, FIN, DE, NL.</b> Twist. Brushed stainless lid. 2 Electrical. 2m cables. For SE, NO, DK, FIN, DE, NL. Only for rectangular	2440
	TKB11	ø57	<b>Powerdot Mini. 1 eluttag, svart, 1,5m kabel. Gäller för SE,NO,DK,FIN,DE,NL.</b> Powerdot Mini. 1electrical black, 1,5m cable. For SE,NO,DK,FIN,DE,NL.	710
	TKB12	ø57	<b>Powerdot Mini. USB A laddare inkl. 2 portar, svart, 1,5m kabel. Gäller för SE,NO,DK,FIN,DE,NL.</b> Powerdot Mini. USB A charging incl. 2 ports, black, 1,5m cable. For SE,NO,DK,FIN,DE,NL.	1070
	TKB19	ø57	<b>Powerdot Mini. USB C laddare inkl. 2 portar, svart, 1,25m kabel. Gäller för SE,NO,DK,FIN,DE,NL.</b> Powerdot Mini. USB C charging incl. 2 ports, black, 1,25m cable. For SE,NO,DK,FIN,DE,NL.	1210
	TKB20	ø70	<b>Powerdot Midi. 1 eluttag, 1 USB C laddare, svart 1,25m kabel. Gäller för SE,NO,DK,FIN,DE,NL.</b> Powerdot Midi. 1 electrical, 1 USB C charging, black, 1,25m cable. For SE,NO,DK,FIN,DE,NL.	1210

Artno	Längd Length mm	Bredd Width mm	Höjd Height mm	Locus SEK		Extra SEK							
				U Avstånd från golv till underkant  U Distance from floor to bottom edge of table top mm	X Avstånd från kortsida till pelare  X Distance from short side to pedestal mm	Top Faner Veneer .10 ek oak .20 björk birch .30 ask ash	Top Vit White Laminate Pelare Fot Pedestal Foot .61 ek oak .62 björk birch .63 ask ash	Top Svart Black Laminate Pelare Fot Pedestal Foot .65 ek oak .66 björk birch .67 ask ash  Top Laminate Pelare Pedestal .71 ek oak .72 björk birch .73 ask ash	Top Svart Black Desktop Pelare Fot Pedestal Foot .91 ek oak .92 björk birch .93 ask ash	Standardbets på ask Standard stain on ash  Vitpigment ek ask White glazed oak ash	Vikt netto Weight net kilos	Vikt brutto Weight gross kilos	Volym Volume
LB1 12070	1200	700	730	705	940	15770	15920	16520	16170	+2370	24	36	0,2
LB1 14070	1400	700	730	705	940	16820	17000	17720	17540	+2520	26	40	0,25
LB1 16070	1600	700	730	705	294	17210	17400	18160	17970	+2580	28	44	0,26
LB1 18070	1800	700	730	705	294	18200	18410	19250	19040	+2730	30	46	0,28
LB1 20070	2000	700	730	705	264	19420	19650	20570	20340	+2910	34	50	0,30
LB1 24070	2400	700	730	705	344	20630	20890	21930	21670	+3090	40	56	0,34
LB1 14080	1400	800	730	705	94	17810	18010	18810	18610	+2670	28	44	0,26
LB1 16080	1600	800	730	705	294	18260	18470	19310	19100	+2740	30	46	0,28
LB1 18080	1800	800	730	705	294	19380	19620	20580	20340	+2910	34	50	0,3
LB1 20080	2000	800	730	705	264	20000	20250	21250	21000	+3000	38	54	0,32
LB1 24080	2400	800	730	705	344	22090	22390	23590	23290	+3310	46	58	0,35
LB1 14090	1400	900	730	705	74	19460	19670	20510	20300	+2920	30	46	0,28
LB1 16090	1600	900	730	705	274	20570	20810	21770	21530	+3090	34	50	0,3
LB1 18090	1800	900	730	705	274	21070	21320	22320	22070	+3160	38	54	0,32
LB1 20090	2000	900	730	705	244	22480	22760	23880	23600	+3370	44	60	0,35
LB1 24090	2400	900	730	705	324	25800	26160	27600	27240	+3870	48	66	0,4
LB1 140100	1400	1000	730	705	74	20370	20600	21520	21290	+3060	34	50	0,3
LB1 160100	1600	1000	730	705	274	20880	21130	22130	21880	+3130	38	54	0,32
LB1 180100	1800	1000	730	705	274	22170	22450	23570	23290	+3330	44	60	0,35
LB1 200100	2000	1000	730	705	244	23690	24000	25240	24930	+3550	48	66	0,4
LB1 240100	2400	1000	730	705	324	27370	27770	29370	28970	+4110	54	68	0,42
LB1 200120	2000	1200	730	705	244	27610	28010	29610	29210	+4140	60	78	0,45
LB1 240120	2400	1200	730	705	324	32250	32760	34800	34290	+4840	70	86	0,48
LB1 300120	3000	1200	730	705	328	41720	42160	43700	43480	+6260	92	120	0,53
LB1 360120	3600	1200	730	705	328	48710	49280	51280	50990	+7310	110	140	0,64
LB1 420120	4200	1200	730	705	388	56080	56790	59280	58920	+8410	128	163	0,75
LB1 480120	4800	1200	730	705	388	62050	62860	65700	65290	+9310	146	186	0,85
LB1 540120	5400	1200	730	705	328	71860	72710	75690	75260	+10780	165	210	0,96
LB1 600120	6000	1200	730	705	328	77180	78130	81460	80890	+11580	183	233	1,07
LB1 660120	6600	1200	730	705	388	86210	87330	91250	90960	+12930	202	256	1,28
LB1 720120	7200	1200	730	705	388	91880	93100	97370	96760	+13780	220	280	1,35

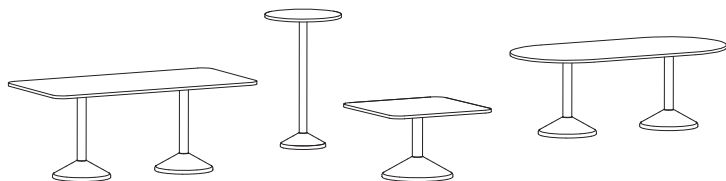

Pivå kommer i rektangulära, kvadratiska, runda och ovala former i en mängd storlekar. Skivan är i fänerad MDF med kantlist. Pelaren är i massivträ med metallkärna och foten är i massivträ med plasttassar. Träslagen är ek, ask, standardbetser på ask och vitpigmenterad ek eller ask. Skivan finns även i laminat (vit, svart, ek, ask) och svart desktop. Som tillval till de rektangulära och ovala skivorna finns olika eluttag att välja mellan. Pivå levereras omonterat. Med hjälp av handverktyg är det enkelt att separera samtliga delar av bordet, efter många års användning.

Pivå comes in rectangular, square, round and oval tabletops in a generous range of sizes. The tops are made of veneered MDF with an edging strip. The pedestals are constructed of solid wood around a metal core and stand on a solid wood base with plastic floor protectors. Choose from oak, ash, standard stains on ash and white glaze on oak or ash. Tabletops are also available in a laminate finish (white, black, oak, ash) and as a black desktop. Several types of electrical outlet are available as optional extras for the rectangular and oval tabletops. Pivå tables are supplied unassembled. Just a few hand tools are all that is needed to disassemble the various components of the tables after many years of continuous use.

Artno

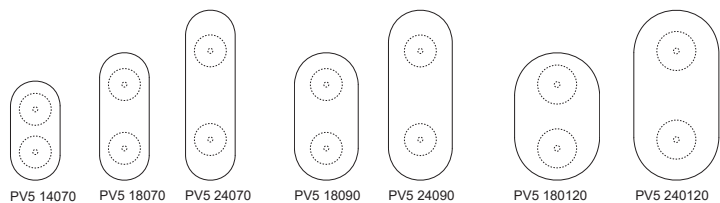
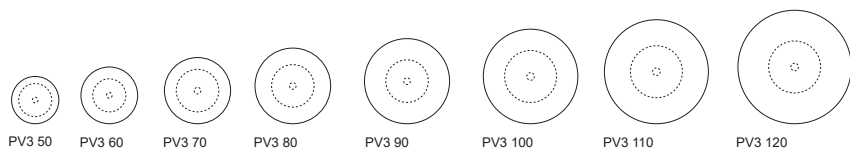
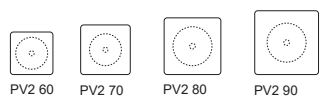
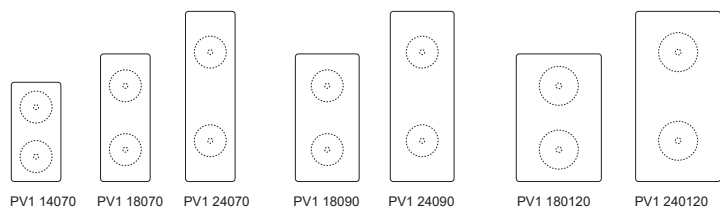

Tillbehör Accessories	Artno	Diam mm		SEK
	TKB4		<b>Kabelgenomföring med elbrunn, svart. Ett löst lock. Exkl. eluttag. Endast för Rektangulära pelarbord och oval.</b> Cable slot with box, black. For socket and leads. One loose covers. Excl. electrical equipment. Only for Pedestal table rectangular and oval	2920
	TKB7	ø115	<b>Twist. Lock borstat rostfritt stål. 2 Eluttag. 2m kabel. Gäller för SE, NO, DK, FIN, DE, NL. Endast för Rektangulära och ovala pelarbord.</b> Twist. Brushed stainless lid. 2 Electrical. 2m cables. For SE, NO, DK, FIN, DE, NL. Only for Pedestal table rectangular and oval	2440
	TKB11	ø57	<b>Powerdot Mini. 1 eluttag, svart, 1,5m kabel. Gäller för SE,NO,DK,FIN,DE,NL. Endast för Rektangulära och ovala pelarbord.</b> Powerdot Mini. 1electrical black, 1,5m cable. For SE,NO,DK,FIN,DE,NL. Only for Pedestal table rectangular and oval	710
	TKB12	ø57	<b>Powerdot Mini. USB A laddare inkl. 2 portar, svart, 1,5m kabel. Gäller för SE,NO,DK,FIN,DE,NL. Endast för Rektangulära och ovala pelarbord.</b> Powerdot Mini. USB A charging incl. 2 ports, black, 1,5m cable. For SE,NO,DK,FIN,DE,NL. Only for Pedestal table rectangular and oval.	1070
	TKB19	ø57	<b>Powerdot Mini. USB C laddare inkl. 2 portar, svart, 1,25m kabel. Gäller för SE,NO,DK,FIN,DE,NL. Endast för Rektangulära och ovala pelarbord.</b> Powerdot Mini. USB C charging incl. 2 ports, black, 1,25m cable. For SE,NO,DK,FIN,DE,NL. Only for Pedestal table rectangular and oval.	1210
	TKB20	ø70	<b>Powerdot Midi. 1 eluttag, 1 USB C laddare, svart 1,25m kabel. Gäller för SE,NO,DK,FIN,DE,NL. Endast för Rektangulära och ovala pelarbord.</b> Powerdot Midi. 1 electrical, 1 USB C charging, black, 1,25m cable. For SE,NO,DK,FIN,DE,NL. Only for Pedestal table rectangular and oval.	1210

Artno	Längd Length mm	Bredd Width mm	Höjd Height mm	Fot Foot Diam mm	Pivå SEK				Extra SEK		Vikt netto Weight net kilos	Vikt brutto Weight gross kilos	Volym Volume
					Top Faner Veneer .10 ek oak .30 ask ash	Top Vit White Laminate Pelare Fot Pedestal Foot .61 ek oak .63 ask ash	Top Svart Black Laminate Pelare Fot Pedestal Foot .65 ek oak .67 ask ash	Top Svart Black Desktop Pelare Fot Pedestal Foot .91 ek oak .93 ask ash	Standardbets på ask Standard stain on ash	Vitpigment ek ask White glazed oak ash			
<b>Rektangulär Rectangulare</b>													
PV1 14070	1400	700	560	450	20780	20970	21750	21220	+2080		46	50	0,37
PV1 14070	1400	700	650, 730	450	21120	21310	22090	21560	+2110		50/54	56/60	0,42/0,47
PV1 14070	1400	700	900, 1050	450	21940	19730	22920	22400	+2190		60/62	66/68	0,55/0,62
PV1 18070	1800	700	560	450	21180	21380	22220	21670	+2120		58	66	0,4
PV1 18070	1800	700	650, 730	450	21520	21720	22550	22000	+2160		60/62	68/70	0,45/0,5
PV1 18070	1800	700	900, 1050	450	22340	20150	23380	22830	+2240		65/68	72/76	0,58/0,65
PV1 24070	2400	700	650, 730	450	23120	23370	24390	23740	+2310		70/74	78/82	0,5/0,55
PV1 24070	2400	700	900, 1050	450	23960	21790	25230	24570	+2400		80/88	88/96	0,63/0,7
PV1 18090	1800	900	650, 730	450	22850	23100	24130	23450	+2280		76/78	84/86	0,49/0,54
PV1 18090	1800	900	900,1050	450	23680	21530	24950	24280	+2370		86/92	94/100	0,62/0,69
PV1 24090	2400	900	650, 730	450	24440	24730	25930	25150	+2450		84/88	94/100	0,55/0,6
PV1 24090	2400	900	900, 1050	450	25270	23160	26770	25990	+2530		94/100	106/110	0,68/0,75
PV1 180120	1800	1200	650, 730	550	29280	29620	31010	30110	+2940		80/85	90/95	0,7/0,78
PV1 180120	1800	1200	900	550	30290	26810	28400	27510	+3030		90	100	0,88
PV1 240120	2400	1200	650, 730	550	30550	30930	32510	31480	+3050		90/95	105/110	0,75/0,83
PV1 240120	2400	1200	900	550	31570	28120	29900	28870	+3160		105	120	1,05
<b>Kvadratisk Square</b>													
PV2 60	600	600	560	450	11000	11110	11580	11270	+1100		20	24	0,24
PV2 60	600	600	650, 730	450	11170	11280	11740	11440	+1110		22/25	26/30	0,27/0,3
PV2 60	600	600	900, 1050	450	11590	11690	12160	11850	+1160		27/29	32/34	0,37/0,44
PV2 70	700	700	560	450	11910	12050	12670	12250	+1190		24	27	0,32
PV2 70	700	700	650, 730	450	12080	12220	12840	12420	+1210		26/27	29/30	0,37/0,4
PV2 70	700	700	900, 1050	450	12500	12650	13250	12850	+1250		30/31	33/35	0,5/0,58
PV2 80	800	800	560	550	14250	14420	15120	14650	+1430		26	33	0,27
PV2 80	800	800	650, 730	550	14480	14650	15350	14890	+1450		28/32	35/39	0,32/0,34
PV2 80	800	800	900, 1050	550	14990	15160	15860	15390	+1490		36/40	42/46	0,39/0,45
PV2 90	900	900	560	550	14770	14950	15690	15210	+1470		35	39	0,28
PV2 90	900	900	650, 730	550	15000	15180	15920	15450	+1490		37/39	41/43	0,32/0,35
PV2 90	900	900	900	550	15510	15690	16430	15950	+1550		42/44	46/49	0,39/0,45

Artno	Diam mm	Höjd Height mm	Fot Foot Diam mm	Pivå SEK				Extra SEK		Vikt netto Weight net kilos	Vikt brutto Weight gross kilos	Volym Volume
				Top Faner Veneer .10 ek oak .30 ask ash	Top Vit White Laminate Pelare Fot Pedestal Foot .61 ek oak .63 ask ash	Top Svart Black Laminate Pelare Fot Pedestal Foot .65 ek oak .67 ask ash	Top Svart Black Desktop Pelare Fot Pedestal Foot .91 ek oak .93 ask ash	Standardbets på ask Standard stain on ash	Vitpigment ek ask White glazed oak ash			
<b>Rund Round</b>												
PV3 50	500	560	350	9150	9220	9550	9340	+910	15	17	0,17	
PV3 50	500	650, 730	350	9300	9370	9700	9490	+930	16/17	18/20	0,2/0,22	
PV3 50	500	900, 1050	350	9670	9740	10070	9860	+960	19/20	22/24	0,27/0,32	
PV3 60	600	560	350	9690	9780	10200	9920	+960	17	20	0,24	
PV3 60	600	650, 730	350	9840	9930	10350	10070	+980	19/20	22/24	0,27/0,3	
PV3 60	600	900, 1050	350	10200	10300	10720	10440	+1020	22/24	26/28	0,37/0,44	
PV3 70	700	560	450	11300	11430	11950	11610	+1130	23	26	0,32	
PV3 70	700	650, 730	450	11470	11600	12120	11780	+1140	25/27	28/30	0,37/0,4	
PV3 70	700	900, 1050	450	11880	12010	12530	12190	+1190	29/31	33/35	0,5/0,58	
PV3 80	800	560	450	11930	12060	12680	12270	+1190	25	32	0,2	
PV3 80	800	650, 730	450	12090	12230	12850	12430	+1210	27/28	34/35	0,22/0,24	
PV3 80	800	900, 1050	450	12510	12660	13260	12860	+1250	30/32	37/39	0,3/0,34	
PV3 90	900	560	450	12570	12740	13440	12970	+1260	26	30	0,21	
PV3 90	900	650, 730	450	12740	12910	13610	13140	+1270	27/29	31/33	0,23/0,25	
PV3 90	900	900, 1050	450	13150	13320	14020	13560	+1310	31/33	35/37	0,3/0,34	
PV3 100	1000	560	550	14980	15170	15950	15430	+1490	36	41	0,29	
PV3 100	1000	650, 730	550	15210	15400	16190	15680	+1520	38/40	43/45	0,32/0,35	
PV3 100	1000	900	550	15720	15910	16700	16180	+1570	42	48	0,41	
PV3 110	1100	560	550	15580	15790	16670	16090	+1560	40	46	0,32	
PV3 110	1100	650, 730	550	15820	16040	16910	16320	+1580	42/44	48/50	0,35/0,4	
PV3 110	1100	900	550	16320	16540	17420	16830	+1630	46	52	0,44	
PV3 120	1200	560	550	16130	16360	17280	16680	+1620	42	48	0,32	
PV3 120	1200	650, 730	550	16370	16600	17520	16920	+1640	44/46	50/52	0,40	
PV3 120	1200	900	550	16880	17100	18020	17430	+1690	48	55	0,45	



Artno	Längd Length mm	Bredd Width mm	Höjd Height mm	Fot Foot Diam mm	Pivå SEK				Extra SEK		Vikt netto Weight net kilos	Vikt brutto Weight gross kilos	Volym Volume
					Top Faner Veneer .10 ek oak .30 ask ash	Top Vit White Laminate Pelare Fot Pedestal Foot .61 ek oak .63 ask ash	Top Svart Black Laminate Pelare Fot Pedestal Foot .65 ek oak .67 ask ash	Top Svart Black Desktop Pelare Fot Pedestal Foot .91 ek oak .93 ask ash	Standardbets på ask Standard stain on ash	Vitpigment ek ask White glazed oak ash			
<b>Oval</b>													
PV5 14070	1400	700	560	450	20780	20970	21750	21220	+2080	46	50	0,37	
PV5 14070	1400	700	650, 730	450	21120	21310	22090	21560	+2110	50/54	56/60	0,42/0,47	
PV5 14070	1400	700	900, 1050	450	21940	19730	22920	22400	+2190	60/62	66/68	0,55/0,62	
PV5 18070	1800	700	560	450	21180	21380	22220	21670	+2120	58	66	0,4	
PV5 18070	1800	700	650, 730	450	21520	21720	22550	22000	+2140	60/62	68/70	0,45/0,5	
PV5 18070	1800	700	900, 1050	450	22340	20150	23380	22830	+2240	65/68	72/76	0,58/0,65	
PV5 24070	2400	700	650, 730	450	23120	23370	24390	23740	+2310	70/74	78/82	0,5/0,55	
PV5 24070	2400	700	900, 1050	450	23960	21790	25230	24570	+2400	80/88	98/96	0,63/0,7	
PV5 18090	1800	900	650, 730	450	22850	23100	24130	23450	+2280	76/78	84/86	0,49/0,54	
PV5 18090	1800	900	900, 1050	450	23680	21530	24950	24280	+2370	86/92	94/100	0,62/0,75	
PV5 24090	2400	900	650, 730	450	24440	24730	25930	25150	+2440	84/88	94/100	0,55/0,6	
PV5 24090	2400	900	900, 1050	450	25270	23160	26770	25990	+2530	94/100	106/110	0,68/0,75	
PV5 180120	1800	1200	650, 730	550	29280	29620	31010	30110	+2930	80/85	90/95	0,7/0,78	
PV5 180120	1800	1200	900	550	30290	26810	28400	27510	+3030	90	100	0,88	
PV5 240120	2400	1200	650, 730	550	30550	30930	32510	31480	+3050	90/95	105/110	0,75/0,83	
PV5 240120	2400	1200	900	550	31570	28120	29900	28870	+3160	105	120	1,05	

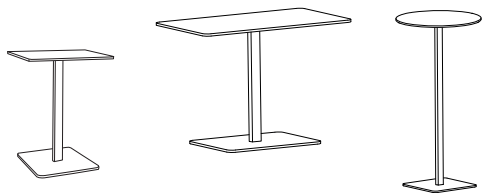

**Pelarbord.**  
Skiva och bottenplatta kompaktlaminat, vit eller svart.  
Pelare i stål vit eller svartlack.  
Bordet kan fästas med dold infästning i golvet.  
Bordet levereras omonterat. Vid order ange höjd.

**Pedestal table.**  
Tabletop/base in white or black compact laminate.  
Pedestal white or black lacquered metal.  
The base-plate can be secured to the floor.  
The table comes unmounted. When ordering state height.

Artno

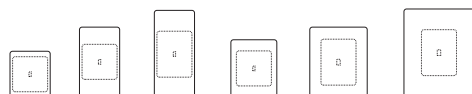

POB10 POB12 POB14 POB16 POB18 POB20

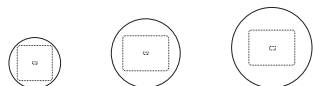

POB40 POB42 POB44

ponoq bord table SEK

Artno	Längd Length mm	Bredd Width mm	Diameter mm	Höjd Height mm	.60 vit white laminate	Vikt brutto Weight gross kilos	Volym Volume
					.61 svart black laminate		
POB10	400	350		400,460,530,620,720,900,1050	5470	15	0,1
POB12	610	350		400,460,530,620,720,900,1050	5660	20	0,03
POB14	760	350		400,460,530,620,720,900,1050	6520	20	0,05
POB16	500	400		400,460,530,620,720,900,1050	5660	16	0,03
POB18	610	500		720	6520	19	0,04
POB20	760	610		720	6940	19	0,03
POB40			ø450	400,460,530,620,720,900,1050	5660	15	0,03
POB42			ø600	400,460,530,620,720,900,1050	6520	17	0,04
POB44			ø700	720	6940	19	0,05

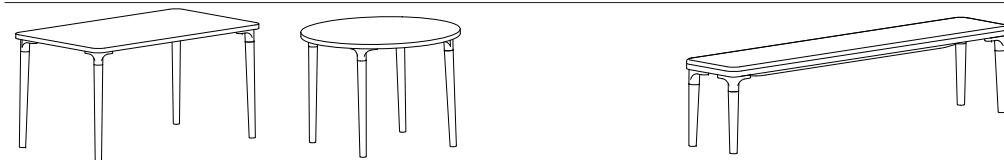

Bord Table

Bänk Bench

### Bord.

Rektangulär skiva = fanerad trälamell, klarlack.

Rund skiva = fanerad MDF, klarlack.

Träslag ek, björk, ask, standardbetser på ask eller vitpigmenterad ek och ask. Alternativt är högtryckslaminat (ek, björk, ask, vit eller svart) och svart desktop.

Ben i massiv trä med fäste av sandgjuten 100% återvunnen aluminium med kulpolerad ytbehandling som standard.

Fästet kan även lackas i standardfärger, var vänlig ange vid beställning. Varje fäste är unikt med sin egen struktur och nyans av aluminium. Benet och fästet går lätt att separera från varandra. Bordet levereras omonterat. Benen skruvas fast under skivan. Specialmått och andra utförande efter förfrågan. Vid order ange höjd.

### Bänk.

Bänken tillverkas i träslagen ek, björk, ask, standardbetser på ask och vitpigmenterad ek eller ask. Det sandgjutna benfästet är av 100 % återvunnen aluminium med kulpolerad ytbehandling som standard. Fästet kan även lackas i standardfärger, var vänlig ange vid beställning. Varje fäste är unikt med sin egen struktur och nyans av aluminium. Dyna i kallsaum klädd i läder eller tyg. Benen är försedda med tasslar. För den cirkulära framtiden så är det enkelt att klä om dynan och separera benfästet från benen. Vid order ange namn på tyg eller läder och utförande.

### Table.

Rektangulär top = veneerad blockboard, clear lacquer.

Round top = veneerad MDF, clear lacquer.

Veener in oak, birch, ash, standard stains on ash or white glazed on oak and ash. Table is also available in High Pressure Laminate of oak, birch, white, black laminate and black desktop.

Legs in solid wood incl. socket-style leg mount made of sand-cast 100% recycled aluminium. The mount comes in a ball burnished finish as standard, but can also be lacquered in one of standard colors. Every mount will be unique with its own structure and shade of aluminium.

The table comes unmounted. The legs are screwed under the table top.

Please enquire for details of non-standard sizes and finishes. When ordering state height.

### Bench.

The bench is manufactured in oak, birch or ash, with standard stains on ash, or white glazed on oak and ash. The leg mount is a sand-moulded casting in 100% recycled aluminium with a ball-burnished finish as standard. The leg mount is also available in our standard lacquer finishes.

Every mount will be unique with its own structure and shade of aluminium. The cold-cured foam cushion is available with a leather or fabric cover. The legs have felt floor protectors. To be able to embrace the circular economy of the future, the cushion can simply be re-covered and the legs can be detached from the leg-mount. When ordering, state the name of the fabric or leather and the desired finish.

### Artno Bord Table

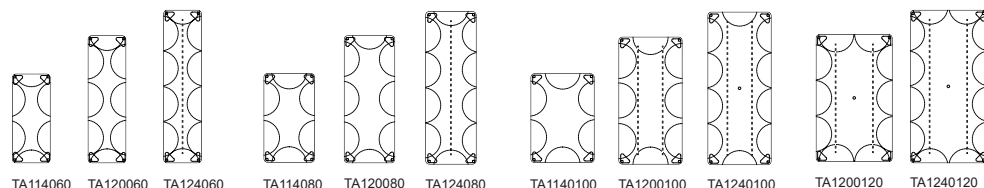

TA114060 TA120060 TA124060 TA114080 TA120080 TA124080 TA1140100 TA1200100 TA1240100 TA1200120 TA1240120

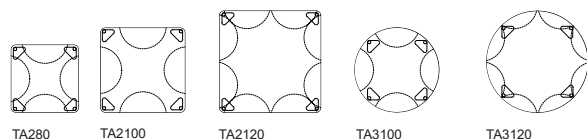

TA280 TA2100 TA2120 TA3100 TA3120

### Artno Bänk Bench

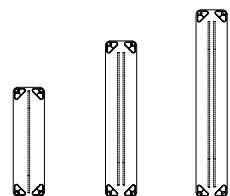

TAB1 140 TAB1 200 TAB1 240

Tillbehör Accessories	Artno	Diam mm		SEK
	TKB4		<b>Kabelgenomföring med elbrunn, svart. Ett löst lock. Exkl. eluttag.</b> Cable slot with box, black. For socket and leads. One loose covers. Excl. electrical equipment.	2920
	TKB7	ø115	<b>Twist. Lock borstat rostfritt stål. 2 Eluttag. 2m kabel.</b> <b>Gäller för SE, NO, DK, FIN, DE, NL.</b> Twist. Brushed stainless lid. 2 Electrical. 2m cables. For SE, NO, DK, FIN, DE, NL.	2440
	TKB11	ø57	<b>Powerdot Mini. 1 eluttag, svart, 1,5m kabel. Gäller för SE,NO,DK,FIN,DE,NL.</b> Powerdot Mini. 1electrical black, 1,5m cable. For SE,NO,DK,FIN,DE,NL.	710
	TKB12	ø57	<b>Powerdot Mini. USB A laddare inkl. 2 portar, svart, 1,5m kabel.</b> <b>Gäller för SE,NO,DK,FIN,DE,NL.</b> Powerdot Mini. USB A charging incl. 2 ports, black, 1,5m cable. For SE,NO,DK,-FIN,DE,NL.	1070
	TKB19	ø57	<b>Powerdot Mini. USB C laddare inkl. 2 portar, svart, 1,25m kabel.</b> <b>Gäller för SE,NO,DK,FIN,DE,NL.</b> Powerdot Mini. USB C charging incl. 2 ports, black, 1,25m cable. For SE,NO,DK,-FIN,DE,NL.	1210
	TKB20	ø70	<b>Powerdot Midi. 1 eluttag, 1 USB C laddare, svart 1,25m kabel.</b> <b>Gäller för SE,NO,DK,FIN,DE,NL.</b> Powerdot Midi. 1 electrical, 1 USB C charging, black, 1,25m cable. For SE,NO,DK,FIN,DE,NL.	1210

Tailor bord table SEK										Extra SEK		
Artno	Längd Length mm	Bredd Width mm	Diam. mm	Höjd Height mm	Top Faner Veneer Ben Legs .10 ek oak .20 björk birch .30 ask ash	Top Vit Laminat White Laminat Ben Legs .61 ek oak .62 björk birch .63 ask ash	Top Svart Black Laminat Ben Legs .65 ek oak .66 björk birch .67 ask ash  Top Laminat Ben Legs .71 ek oak .72 björk birch .73 ask ash	Top Svart Black Desktop Ben Legs .91 ek oak .92 björk birch .93 ask ash	Standardbets på ask Standard stain on ash  Vitpigment ek ask White glazed oak ash	Benfäste i svart eller vit Socket style-leg in black or white	Vikt brutto Weight gross kilos	Volym Volume
<b>Rektangulär Rectangulare</b>												
TA114060	1400	600		730,900	14830	15020	15790	15520	+2230	+740	25	0,12
TA120060	2000	600		730,900	16580	16810	17910	17680	+2490	+740	31	0,17
TA124060	2400	600		730,900	19450	19680	21230	20670	+2930	+740	35	0,2
TA114080	1400	800		730,900	15980	16180	17000	16660	+2400	+740	30	0,16
TA120080	2000	800		730,900	18490	18830	19930	19600	+2770	+740	38	0,21
TA124080	2400	800		730,900	21710	21980	23530	22970	+3250	+740	43	0,25
TA1140100	1400	1000		730,900	18000	18210	19440	18760	+2690	+740	34	0,19
TA1200100	2000	1000		730,900	23370	23650	25010	24370	+3500	+740	44	0,25
TA1240100	2400	1000		730,900	29560	29890	31510	30820	+4430	+930	51	0,3
TA1200120	2000	1200		730,900	29560	29890	31270	30630	+4430	+930	52	0,29
TA1240120	2400	1200		730,900	35830	36250	37850	37180	+5380	+930	59	0,35
<b>Kvadratisk Square</b>												
TA280	800	800		730,900	13590	13670	14360	13930	+2050	+740	22	0,1
TA2100	1000	1000		730,900	18090	18210	18980	18490	+2700	+740	28	0,14
TA2120	1200	1200		730,900	20260	20410	21240	20680	+3040	+740	35	0,19
<b>Rund Round</b>												
TA3100			ø1000	730,900	13910	14030	14800	14290	+2090	+740	28	0,14
TA3120			ø1200	730,900	15130	15290	16110	15560	+2270	+740	35	0,19

Bänk Bench SEK										Extra SEK				
Artno	Längd Length mm	Bredd Width mm	Höjd Height mm	Träslag Wood .10 ek oak .20 björk birch .30 ask ash	Standardbets på ask Standard stain on ash  Vitpigment ek ask White glazed oak ash	Benfäste i svart eller vit Socket style-leg in black or white	Tyg Fabric Prisgrupp 1 Pricegroup 1	Tyg Fabric Prisgrupp 2 Pricegroup 2	Tyg Fabric Prisgrupp 3 Pricegroup 3	Tyg Fabric Prisgrupp 4 Pricegroup 4	Standard Läder Leather	Tygåtgång på 140 cm bredd Requirement of fabric on 140 cm width	Vikt brutto Weight gross kilos	Volym Volume
TAB1 14040	1400	400	470	12650	+1890	+740	+1310	+1410	+1540	+1810	+1380	85cm	30	0,34
TAB1 20040	2000	400	470	14650	+2200	+740	+1370	+1460	+1600	+1890	+2220	90cm	45	0,44
TAB1 24040	2400	400	470	15760	+2370	+740	+1940	+2100	+2330	+2810	+3250	150cm	55	0,58



### Bord.

Bordsskiva av trälamell med faner i ek, bjök, körsbär, standardbetser på ek och vitpigment på ek. Alternativt är högtryckslaminat i ek, björk, ask, vit och svart laminat. Ytbehandling är klarlack alternativt olja+lack. Ben i massivt stål med blåstrad yta i mattkrom eller slipad yta i blankkrom. Vissa bordsstorlekar i höjd 720mm finns med två iläggsskivor à 550mm, med faneriktning tvärs bordslängden, har en eller två ställbara stödben och träreglar. Andra mått och utförande efter förfrågan. Bordet levereras omonterat. Benen skruvas fast under bordsskivan. Vid beställning ange höjd och utförande på ben.

### Table.

Table top in blockboard of veneer in oak, birch, cherry, standard stains on oak or white glazed on oak. Table is also available in High Pressure Laminate in oak, birch, ash, white and black laminate. Finish clear lacquer or oil+lacquer. Legs of solid steel with a shot-blasted matt chrome finish, or a polished chrome surface. Some sizes of tables in height 720mm have two extra leaves à 550mm, with veneer direction across length of table, one or two adjustable supporting legs and wooden rails. Special sizes and other finishes upon request. The table comes unmounted. The legs are screwed under the table top. When ordering state height and execution of legs.

Artno

\*Dessa storlekar kan erhållas med 2 iläggsskivor à 550mm för höjd 720mm.  
\*These sizes are available with 2 extra leaves à 550mm for height 720mm.

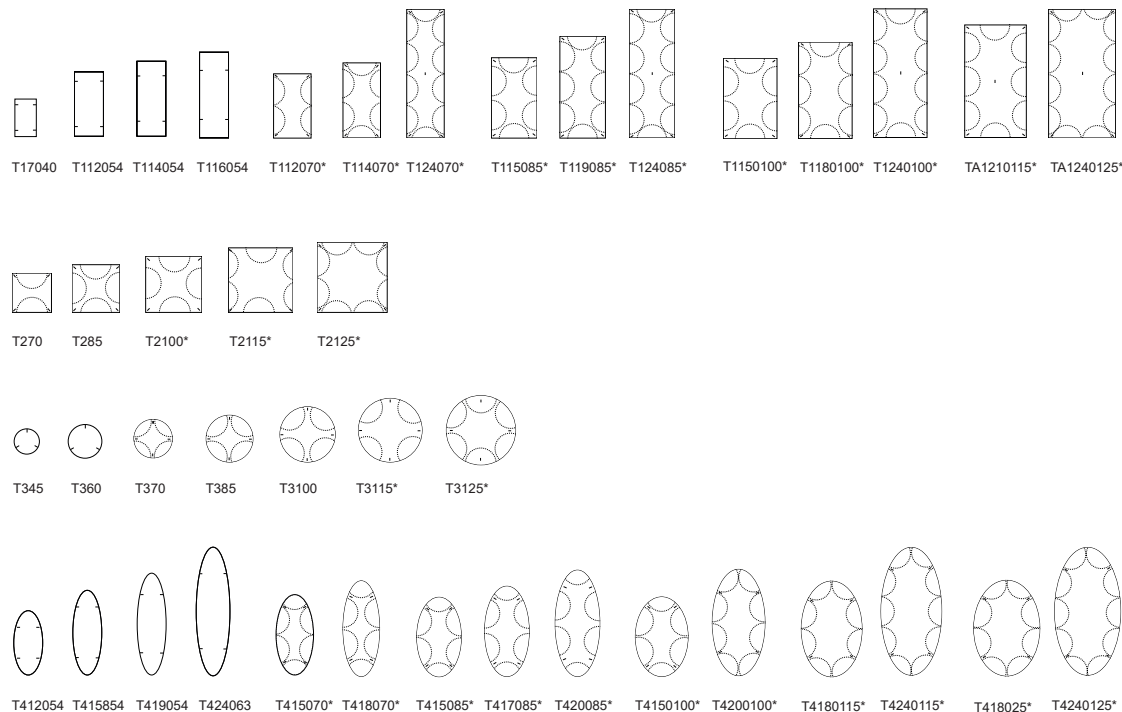

Tillbehör Accessories	Artno	Diam mm		SEK
	TKB4		<b>Kabelgenomföring med elbrunn, svart. Ett löst lock. Exkl. eluttag.</b> Cable slot with box, black. For socket and leads. One loose covers. Excl. electrical equipment.	2920
	TKB7	ø115	<b>Twist. Lock borststål rostfritt stål. 2 Eluttag. 2m kabel. Gäller för SE, NO, DK, FIN, DE, NL.</b> Twist. Brushed stainless lid. 2 Electrical. 2m cables. For SE, NO, DK, FIN, DE, NL.	2440
	TKB11	ø57	<b>Powerdot Mini. 1 eluttag, svart, 1,5m kabel. Gäller för SE, NO, DK, FIN, DE, NL.</b> Powerdot Mini. 1 electrical black, 1,5m cable. For SE, NO, DK, FIN, DE, NL.	710
	TKB12	ø57	<b>Powerdot Mini. USB A laddare inkl. 2 portar, svart, 1,5m kabel. Gäller för SE, NO, DK, FIN, DE, NL.</b> Powerdot Mini. USB A charging incl. 2 ports, black, 1,5m cable. For SE, NO, DK, FIN, DE, NL.	1070
	TKB19	ø57	<b>Powerdot Mini. USB C laddare inkl. 2 portar, svart, 1,25m kabel. Gäller för SE, NO, DK, FIN, DE, NL.</b> Powerdot Mini. USB C charging incl. 2 ports, black, 1,25m cable. For SE, NO, DK, FIN, DE, NL.	1210
	TKB20	ø70	<b>Powerdot Midi. 1 eluttag, 1 USB C laddare, svart 1,25m kabel. Gäller för SE, NO, DK, FIN, DE, NL.</b> Powerdot Midi. 1 electrical, 1 USB C charging, black, 1,25m cable. For SE, NO, DK, FIN, DE, NL.	1210

Rektangulär Rectangulare				Trippo bord table SEK				Extra SEK		Vikt brutto Weight gross kilos	Volym Volume
Artno	Längd Length mm	Bredd Width mm	Höjd Height mm	Top Faner Veneer .10 ek oak .20 björk birch	Top Faner Veneer .43 körsbär cherry	Top .60 Vit White laminat	Top .61 Svart Laminat Black Laminat	Skiva olja+lack Standardbets, Vit pigment på ek Top oil+lacquer Standard stain, White glazed on oak	2 iläggsskivor á 550mm endast höjd 720mm 2 loose leaves á 550mm only height 720mm *1 stödben support leg *2 stödben support legs		
T17040	700	400	400,460,530	8800	8970	8940	9490	+430		13	0,05
T17040	700	400	620,720	13810	13980	13880	14480	+430		22	0,06
T112054	1200	540	400,460,530	10730	11030	10910	11560	+730		18	0,07
T112054	1200	540	620,720	15760	16070	15940	16590	+730		27	0,08
T114054	1400	540	400,460,530	11100	11410	11280	12020	+770		18	0,08
T114054	1400	540	620,720	16110	16440	16290	17040	+770		27	0,09
T116054	1600	540	400,460,530	11850	12210	12030	12800	+900		19	0,08
T116054	1600	540	620,720	16880	17230	17060	17820	+900		28	0,09
T112070	1200	700	400,460,530	11640	12000	11830	12530	+880		22	0,1
T112070	1200	700	620,720	16650	17010	16830	17530	+880	*+16090 faner veneer *+16840 laminat	31 38	0,11 0,14
T114070	1400	700	400,460,530	12610	13030	12800	13620	+1000		24	0,12
T114070	1400	700	620,720	17630	18020	17810	18620	+1000	*+16090 faner veneer *+16840 laminat	33 40	0,13 0,16
T124070	2400	700	620,720	23100	23700	23350	24850	+1410	**+16050 faner veneer **+16940 laminat	44 51	0,15 0,18
T115085	1500	850	400,460,530	13830	14310	14050	14840	+1190		27	0,12
T115085	1500	850	620,720	18840	19310	19060	19860	+1190	**+18960 faner veneer **+19640 laminat	36 43	0,13 0,16
T119085	1900	850	620,720	20030	20600	20390	21570	+1360	**+18960 faner veneer **+19640 laminat	40 47	0,15 0,23
T124085	2400	850	620,720	26270	27050	26540	28050	+1920	**+16050 faner veneer **+16940 laminat	52 59	0,18 0,21
T1150100	1500	1000	620,720	20210	20770	20420	21650	+1380	**+18740 faner veneer **+19640 laminat	39 46	0,18 0,21
T1180100	1800	1000	620,720	21050	21670	21400	22590	+1530	**+18740 faner veneer **+19640 laminat	43 50	0,21 0,24
T1240100	2400	1000	620,720	28500	29390	28830	30480	+2230	**+16050 faner veneer **+16940 laminat	57 64	0,28 0,31
T1210115	2100	1150	620,720	28620	29540	28920	30390	+2250	**+17380 faner veneer **+18410 laminat	57 64	0,27 0,3
T1240125	2400	1250	620,720	34140	35390	34580	36180	+3070	**+18120 faner veneer **+19240 laminat	67 74	0,33 0,36

Kvadratisk Square				Trippo bord table SEK				Extra SEK			
Artno	Längd Length mm	Bredd Width mm	Höjd Height mm	Top Faner Veneer .10 ek oak .20 björk birch	Top Faner Veneer .43 körsbär cherry	Top .60 Vit White Laminate	Top .61 Svart laminat Black Laminate  Top Laminate .71 ek oak .72 björk birch .73 ask ash	Skiva olja+lack Standardbets, Vit pigment på ek Top oil+lacquer Standard stain, White glazed on oak	2 iläggsskivor á 550mm endast höjd 720mm 2 loose leaves á 550mm only height 720mm **2 stödben support legs	Vikt brutto Weight gross kilos	Volym Volume
T270	700	700	400,460.530	10180	10450	10260	10880	+650		15	0,07
T270	700	700	620,720	15190	15450	15270	15870	+650		24	0,08
T285	850	850	400,460.530	11350	11680	11440	12130	+810		18	0,08
T285	850	850	620,720	16360	16670	16450	17140	+810		27	0,09
T2100	1000	1000	400,460.530	12730	13140	12860	13620	+1020		20	0,17
T2100	1000	1000	620,720	17770	18170	17890	18660	+1020	**+18740 faner, veneer **+19640 laminate	29 36	0,18 0,21
T2115	1150	1150	400,460.530	14130	14650	14300	15150	+1250		27	0,18
T2115	1150	1150	620,720	19150	19640	19310	20150	+1250	**+20070 faner, veneer **+21130 laminate	36 43	0,19 0,22
T2125	1250	1250	400,460.530	14760	15290	14920	15870	+1330		30	0,18
T2125	1250	1250	620,720	20030	20290	19930	21160	+1330	**+20810 faner, veneer **+21940 laminate	39 46	0,19 0,22

Rund Round			Trippo bord table SEK				Extra SEK			
Artno	Diameter mm	Höjd Height mm	Top Faner Veneer .10 ek oak .20 björk birch	Top Faner Veneer .43 körsbär cherry	Top .60 Vit White Laminate	Top .61 Svart Laminat Black Laminate  Top Laminate .71 ek oak .72 björk birch .73 ask ash	Skiva olja+lack Standardbets, Vit pigment på ek Top oil+lacquer Standard stain, White glazed on oak	2 iläggsskivor á 550mm endast höjd 720mm 2 loose leaves á 550mm only height 720mm *1 stödben supporting leg ** 2 stödben supporting legs	Vikt brutto Weight gross kilos	Volym Volume
T345	ø450	400,460.530	6580	6720	6660	7090	+340		9	0,04
T345	ø450	620,720	10340	10480	10410	10850	+340		20	0,05
T360	ø600	400,460.530	7570	7760	7650	8080	+460		12	0,05
T360	ø600	620,720	11340	11520	11400	11840	+460		23	0,06
T370	ø700	400,460.530	10180	10450	10250	10700	+650		16	0,06
T370	ø700	620,720	15190	15450	15270	15870	+650		25	0,07
T385	ø850	400,460.530	11350	11680	11440	12130	+810		20	0,07
T385	ø850	620,720	16360	16670	16450	17140	+810		29	0,08
T3100	ø1000	400,460.530	12730	13140	12860	13620	+1020		21	0,09
T3100	ø1000	620,720	17770	18170	17890	18660	+1020		30	0,1
T3115	ø1150	400,460.530	14130	14650	14290	15050	+1250		28	0,12
T3115	ø1150	620,720	19150	19640	19290	20070	+1250	*+18780 faner veneer *+19840 laminate	37 44	0,13 0,16
T3125	ø1250	400,460.530	14760	15290	14920	15870	+1330		27	0,13
T3125	ø1250	620,720	19770	20290	19910	20750	+1330	**+20810 faner veneer **+21940 laminate	36 41	0,14 0,17

Oval				Trippo bord table SEK				Extra SEK			
Artno	Längd Length mm	Bredd Width mm	Höjd Height mm	Top Faner Veneer .10 ek oak .20 björk birch	Top Faner Veneer .43 körsbär cherry	Top .60 Vit White laminate	Top .61 Svart Laminat Black Laminate  Top Laminate .71 ek oak .72 björk birch .73 ask ash	Skiva olja+lack Standardbets, Vit pigment på ek Top oil+lacquer Standard stain, White glazed on oak	2 iläggsskivor á 550mm endast höjd 720mm 2 loose leaves á 550mm only height 720mm *1 stödben support leg *2 stödben support legs	Vikt brutto Weight gross kilos	Volym Volume
T412054	1200	540	400,460.530	10740	11050	10920	11580	+730		18	0,07
T412054	1200	540	620,720	15770	16080	15950	16600	+730		27	0,08
T415854	1580	540	400,460.530	11790	12150	11980	12740	+900		21	0,08
T415854	1580	540	620,720	16810	17160	17000	17770	+900		30	0,09
T419054	1900	540	400,460.530	12290	12680	12500	13350	+960		24	0,06
T419054	1900	540	620,720	17290	17670	17500	18360	+960		33	0,07
T424063	2400	630	400,460.530	14460	14980	14710	16190	+1300		31	0,1
T424063	2400	630	620,720	19480	19990	19720	21210	+1300		40	0,11
T415070	1500	700	400,460.530	12390	12800	12610	13430	+980		25	0,1
T415070	1500	700	620,720	17430	17820	17650	18430	+980	*+16090 faner veneer *+16840 laminate	34 41	0,11 0,14
T418070	1800	700	400,460.530	13700	14180	13890	14780	+1190		28	0,12
T418070	1800	700	620,720	18710	19190	18910	19790	+1190	*+16090 faner veneer *+16840 laminate	37 44	0,13 0,16
T415085	1500	850	400,460.530	13830	14310	14010	14820	+1200		28	0,12
T415085	1500	850	620,720	18840	19310	19040	19840	+1200	**+18740 faner veneer **+19640 laminate	37 44	0,13 0,16
T417085	1700	850	620,720	19900	20440	20090	20860	+1350	**+18740 faner veneer **+19640 laminate	40 47	0,13 0,16
T420085	2000	850	620,720	20490	21080	20850	22030	+1440	**+18740 faner veneer **+19640 laminate	42 49	0,16 0,19
T4150100	1500	1000	400,460.530	15190	15760	15400	16630	+1390		31	0,13
T4150100	1500	1000	620,720	20210	20770	20420	21650	+1390	**+18740 faner veneer **+19640 laminate	40 47	0,14 0,17
T4200100	2000	1000	620,720	22150	22850	22440	23740	+1700	**+18740 faner veneer **+19640 laminate	48 55	0,33 0,36
T4180115	1800	1150	620,720	23740	24510	24080	25450	+1940	**+20070 faner veneer **+21130 laminate	48 55	0,24 0,27
T4240115	2400	1150	620,720	29800	30930	30220	31830	+2840	**+20070 faner veneer **+21130 laminate	61 68	0,3 0,33
T4180125	1800	1250	620,720	24860	25710	25210	26370	+2090	**+20810 faner veneer **+21940 laminate	56 63	0,26 0,29
T4240125	2400	1250	620,720	31430	32670	31850	33460	+3070	**+20810 faner veneer **+21940 laminate	66 73	0,43 0,46



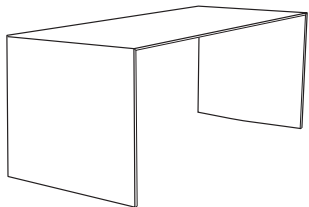

### Bord.

Vit kompaktaminat alternativt svartbets på ask.  
Andra längder och höjder efter förfrågan. Bordet levereras monterat  
Vid order ange höjd.

### Table.

White compact laminate or black stain on ash.  
Other lengths and heights upon request. The table comes pre-assembled.  
When ordering state height.

### Artno

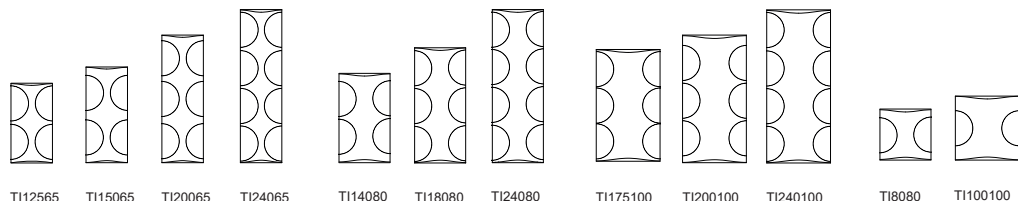

Thinner SEK							
Artno	Längd Length mm	Bredd Width mm	Höjd Height mm	.60 vit white laminate	.30 svartbets ask col.11 black stain on ash col. 11	Vikt brutto Weight gross kilos	Volym Volume
TI12565	1250	650	400,480	18140	27020	25/26	0,5/0,55
TI12565	1250	650	730,900	25600	35730	28/31	0,8/1,0
TI15065	1500	650	400,480	19670	28700	35/36	0,6/0,65
TI15065	1500	650	730,900	25830	36070	38/41	0,95/1,15
TI20065	2000	650	730,900	28290	39140	48/51	1,25/1,5
TI24065	2400	650	730,900	30390	42720	58/61	1,45/1,8
TI14080	1400	800	400,480	20960	30440	31/32	0,67/0,75
TI14080	1400	800	730,900	27220	38020	34/37	1,1/1,3
TI18080	1800	800	730,900	28950	40200	44/47	1,35/1,65
TI24080	2400	800	730,900	34850	48280	54/57	1,8/2,15
TI175100	1750	1000	730,900	31870	44000	40/43	1,65/2,0
TI200100	2000	1000	730,900	33970	47570	50/53	1,85/2,25
TI240100	2400	1000	730,900	39350	54040	60/63	2,2/2,65
TI8080	800	800	400,480	19020	28120	21/22	0,4/0,45
TI8080	800	800	730,900	26700	36990	24/27	0,66/0,8
TI100100	1000	1000	400,480	21340	31010	30/31	0,62/0,67
TI100100	1000	1000	730,900	27730	38760	33/36	1,0/1,2

Tillbehör Accessories	Artno	Diam mm		SEK
	TKB4		<b>Kabelgenomföring med elbrunn, svart. Ett löst lock. Exkl. eluttag.</b> Cable slot with box black. For socket and leads. One loose covers. Excl. electrical equipment.	3200
	TKB7	ø115	<b>Twist. Lock borstat rostfritt stål. 2 Eluttag. 2m kabel. Gäller för SE, NO, DK, FIN, DE, NL.</b> Twist. Brushed stainless lid. 2 Electrical. 2m cables. For SE, NO, DK, FIN, DE, NL.	2440
	TKB5	ø68	<b>Kabelgenomföring.</b> Cable slot.	560
	TIH		<b>Låsbara hjul, 4st svart.</b> Lockable castors. 4pcs black.	2180/4pcs



### Bord.

Rektangulär skiva = fanerad trälamell.

Rund skiva = fanerad MDF.

Träslag är ek, björk, ask, standardbets på ask, vitpigmenterad ek eller ask, vit eller svart laminat och svart desktop. Ytbehandling klarlack.

Benbock i massiv trä inkl. ställföter. Knut i svartlackad plywood. Bordet levereras omonterat. Benstativet skruvas fast på skivan.

### Pedestal table.

Rectangulare top = veneered blockboard.

Round top = veneered MDF.

Wood in oak, birch, ash, standard stains on ash or white glazed on oak or ash, and white or black laminate and black desktop. Finish in clear lacquer. Legs solid wood incl. adjustable feet on the legs. Knot in black plywood. The table comes unmounted. The

legs are screwed under the table top.

Artno

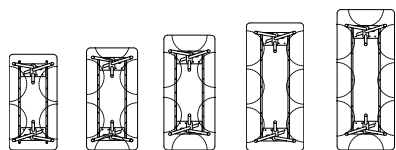

BQ115075 BQ116080 BQ118080 BQ120090 BQ122090

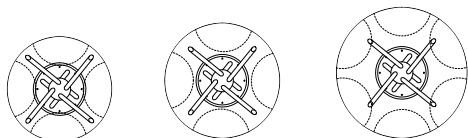

BQ3100 BQ3110 BQ3125

Tillbehör Accessories	Artno	Diam mm		SEK
	TKB4		<b>Kabelgenomföring med elbrunn, svart. Ett löst lock. Exkl. eluttag. Endast till rektangulära bord</b> Cable slot with box, black. For socket and leads. One loose covers. Excl. electrical equipment. Only for rectangular tables.	3200
	TKB7	ø115	<b>Twist. Lock borstat rostfritt stål. 2 Eluttag. 2m kabel. Gäller för SE, NO, DK, FIN, DE, NL. Endast till rektangulära bord.</b> Twist. Brushed stainless lid. 2 Electrical. 2m cables. For SE, NO, DK, FIN, DE, NL. Only rectangular tables	2920
	TKB11	ø57	<b>Powerdot Mini. 1 eluttag, svart, 1,5m kabel. Gäller för SE,NO,DK,FIN,DE,NL. Endast till rektangulära bord.</b> Powerdot Mini. 1 electrical black, 1,5m cable. For SE,NO,DK,FIN,DE,NL. Only for rectangular tables.	740
	TKB12	ø57	<b>Powerdot Mini. USB A laddare inkl. 2 portar, svart, 1,5m kabel. Gäller för SE,NO,DK,FIN,DE,NL. Endast till rektangulära bord.</b> Powerdot Mini. USB A charging incl. 2 ports, black. 1,5m cable. For SE,NO,DK,FIN,DE,NL. Only for rectangular tables.	1180
	TKB19	ø57	<b>Powerdot Mini. USB C laddare inkl. 2 portar, svart, 1,25m kabel. Gäller för SE,NO,DK,FIN,DE,NL. Endast till rektangulära bord.</b> Powerdot Mini. USB C charging incl. 2 ports, black. 1,25m cable. For SE,NO,DK,FIN,DE,NL. Only for rectangular tables.	1210
	TKB20	ø70	<b>Powerdot Midi. 1 eluttag, 1 USB C laddare, svart 1,25m kabel. Gäller för SE,NO,DK,FIN,DE,NL. Endast till rektangulära bord.</b> Powerdot Midi. 1 electrical, 1 USB C charging, black. 1,25m cable. For SE,NO,DK,FIN,DE,NL. Only for rectangular tables.	1210

# BOUQUET Jesper Ståhl 2016

Artno	Längd Length mm	Bredd Width mm	Diameter mm	Höjd Height mm	Bouquet SEK			Extra SEK			
					Top Faner Veneer Ben Legs .10 ek oak .20 björk birch .30 ask ash	Top Vit White Laminate Ben Legs .61 ek oak .62 björk birch .63 ask ash	Top Svart Laminat Black Laminate Ben Legs .65 ek oak .66 björk birch .67 ask ash	Top Svart Black Desktop Ben Legs .91 ek oak .92 björk birch .93 ask ash	Standardbets på ask Standard stain on ash  Vitpigment ek ask White glazed oak ash	Vikt brutto Weight gross kilos	Volym Volume
<b>Rektangulär Rectangulare</b>											
BQ115075	1500	750		745	19560	19790	20600	20390	+2950	36	0,56
BQ116080	1600	800		745	20660	20870	21680	21540	+3100	38	0,58
BQ118080	1800	800		745	22110	22330	23330	22990	+3330	40	0,60
BQ120090	2000	900		745	23620	23880	25200	24580	+3540	40	0,64
BQ122090	2200	900		745	24760	25080	26550	25900	+3720	44	0,66
<b>Rund Round</b>											
BQ3100			ø1000	745	12660	12770	13550	13050	+1920	25	0,20
BQ3110			ø1100	745	12730	12870	13640	13130	+1930	28	0,23
BQ3125			ø1250	745	14050	14190	15030	14470	+2100	34	0,26

# BUFF Joel Karlsson Krook&Tjäder Design 2012



## Bord.

Skiva i HI-MACS i färg Alpine White.  
Ben i oljad massiv ek, björk och ask.  
Bordet levereras monterat.  
Vid order ange höjd och utförande på ben.

## Table.

Top in HI-MACS in color Alpine White.  
Legs in solid oak, birch, ash in oiled finish.  
The table comes pre-assembled.  
When ordering state height and wood of legs.

Artno

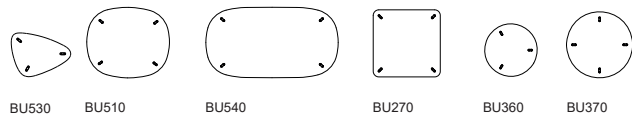

BU530

BU510

BU540

BU270

BU360

BU370

Artno	Längd Length mm	Bredd Width mm	Diameter mm	Höjd Height mm	Buff SEK		
					.70 Skiva Top Alpine white  ben oljade ek, björk, ask legs oil oak, birch, ash	Vikt brutto Weight gross kilos	Volym Volume
BU530	552	406		400,500,600	7990	7	0,13/0,15/0,18
BU510	874	745		400,500,600,720	12380	20	0,32/0,4/0,47/0,55
BU540	1400	745		400,500,600	14420	35	0,5/0,63/0,74
BU270	700	700		400,500,600,720	12290	20	0,22/0,28/0,33/0,4
BU360			ø600	400,500,600,720	8480	13	0,18/0,22/0,26/0,3
BU370			ø700	400,500,600,720	10650	16	0,24/0,29/0,35/0,4

## Bord och Skål.

Bordet finns i fyra höjder och tre storlekar på skivan. Foten är av gjuten betong eller lackad i standardfärger. Stativet finns i blank krom eller lackad i standardfärger, med eller utan ring. Bordsskivan i massiv ek, björk, ask, standardfärger, standardbetsar på ask och vitpigmenterad ek eller ask. Som tillbehör finns lackad fot i standardfärger och tre krokar i blankkrom som hängs under bordsskivan.

Skålen inkl. planteringskärl finns i fyra höjder och en storlek. Foten är av gjuten betong. Pelare i blankkrom eller standardfärger. Planteringskärl är svart ABS plast. Som tillbehör finns lackad fot i standardfärger.

Den gjutna betongfoten får bäst stabilitet på hårda golv som parkett, klinkers, betong, plastmatta eller liknande. Undvik att placera bordet på tjocka och mjuka mattor med lugg där Lollipop kan bli något instabilt.

Bordet och skål levereras monterat. Vid beställning ange artikelnummer, utförande och höjd.

## Table and Bowl.

The table comes in four heights with tops in three different sizes. Choose a frame with or without a ring in shiny chrome or standard colors finishes. The table top is in solid oak, birch, ash or finished in our standard colors, standard stains on ash or white glazed oak or ash. Maximum three hooks in polished chrome are available as optional extras to hang things on below the table surface.

The planter, complete with a bowl for plants, comes in four heights and one size. The cast concrete foot is also available lacquered in our standard colours. The pillar comes in polished chrome or standard colors. The planting bowl is in black plastic ABS.

The concrete foot stands best on surfaces such as parquet flooring, quarry tiles, concrete, plastic matting or similar. Avoid placing the table on thick rugs or those with a soft pile as there is a risk that the table may be less stable on this kind of surface.

Tables and planters are delivered assembled. When ordering, please state article number, height and choice of finish.

## Artno Bord Table



LO329 50R = H 500/750  
LO329 55R = H 550/800

ø290



LO338 50R = H 500/750  
LO338 55R = H 550/800

ø380

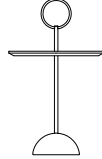

LO350 50R = H 500/750  
LO350 55R = H 550/800

ø500



LO329 90R = H 900/1175  
LO329 105R = H 1050/1325

ø290



LO338 90R = H 900/1175  
LO338 105R = H 1050/1325

ø380

## Artno Skål Bowl



LOS60 = H 600  
LOS65 = H 650



LOS100 = H 1000  
LOS115 = H 1150



LO329 50U = H 500  
LO329 55U = H 550

ø290

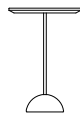

LO338 50U = H 500  
LO338 55U = H 550

ø380

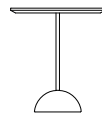

LO350 50U = H 500  
LO350 55U = H 550

ø500



LO329 90U = H 900  
LO329 105U = H 1050

ø290

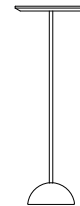

LO338 90U = H 900  
LO338 105U = H 1050

ø380

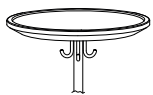

LOK

Krok blankkrom (max 3 krokar per bord)  
Hooks polished chrome (max 3 hooks per table)

				Lollipop SEK	Extra SEK		
Artno Pelare blankkrom Pedestal polish chrome	Artno Pelare lack Pedestal color	Diameter mm	Höjd skiva/Höjd med ring Height top/height inkl. ring mm	.10 ek oak .20 björk birch .30 ask ash .50 lack color	Standardbets på ask Standard stain on ash Vitpigment ek ask White glazed oak ash	Vikt brutto Weight gross kilos	Volym Volume
<b>Inclusive Ring</b>							
LO329 50RK*	LO329 50RL*	ø290	500/750	4620	+320	9	0,10
LO329 55RK*	LO329 55RL*	ø290	550/800	4620	+320	9	0,10
LO329 90RK	LO329 90RL	ø290	900/1175	5570	+320	15	0,20
LO329 105RK	LO329 105RL	ø290	1050/1325	5570	+320	15	0,20
LO338 50RK*	LO338 50RL*	ø380	500/750	5050	+380	10	0,15
LO338 55RK*	LO338 55RL*	ø380	550/800	5050	+380	10	0,15
LO338 90RK	LO338 90RL	ø380	900/1175	5980	+380	16	0,20
LO338 105RK	LO338 105RL	ø380	1050/1325	5980	+380	16	0,20
LO350 50RK	LO350 50RL	ø500	500/750	6430	+510	17	0,16
LO350 55RK	LO350 55RL	ø500	550/800	6430	+510	17	0,16
<b>Exclusive Ring</b>							
			<b>Höjd skiva Height top</b>				
LO329 50UK*	LO329 50UL*	ø290	500	3960	+320	8	0,07
LO329 55UK*	LO329 55UL*	ø290	550	3960	+320	8	0,07
LO329 90UK	LO329 90UL	ø290	900	4700	+320	14	0,17
LO329 105UK	LO329 105UL	ø290	1050	4700	+320	14	0,17
LO338 50UK*	LO338 50UL*	ø380	500	4390	+380	9	0,10
LO338 55UK*	LO338 55UL*	ø380	550	4390	+380	9	0,10
LO338 90UK	LO338 90UL	ø380	900	5110	+380	15	0,17
LO338 105UK	LO338 105UL	ø380	1050	5110	+380	15	0,17
LO350 50UK	LO350 50UL	ø500	500	5590	+510	16	0,16
LO350 55UK	LO350 55UL	ø500	550	5590	+510	16	0,16
Artno Skål inkl. planteringskårl Pelare blankkrom Bowl incl. planter Pedestal polish chromed	Artno Skål inkl. planteringskårl. Pelare lack. Bowl incl. planter Pedestal color	Diameter mm	Höjd Height	<b>Skål Bowl SEK</b>			
LOS60K	LOS60L	ø250	600	4550		15	0,10
LOS65K	LOS65L	ø250	650	4550		15	0,10
LOS100K	LOS100L	ø250	1000	4670		17	0,12
LOS115K	LOS115L	ø250	1150	4670		17	0,12
				<b>Tillbehör Accessories SEK</b>			
*LOF 20 lackad fot painted base foot		ø200		+910			
LOF 25 lackad fot painted base		ø250		+1010			
LOK Krok blankkrom max 3st Hooks polished chrome max 3pcs				+120/pcs			

# CAP PODIUM Roger Persson 2021

Pelare och skiva i massiv trä. Skivan har en nedfasad kant. Träslagen är ek, björk, ask, standardfärger, standardbetsar på ask och vitpigmenterad ek och ask. Vid standardfärg är skivan i MDF. Specialmått och andra utförande efter förfrågan. Podium levereras monterad med skiva. Vid beställning ange artikelnummer och höjd.

Pedestal and table top in solid wood. The table top is milled down. Choose between oak, birch, ash, standard colors, standard stain on ash and white glazed on oak and ash. When using the standard colors the table top made in MDF. Special dimensions and other designs on request. The Cap podium comes mounted. When ordering state article number and height.

Artno

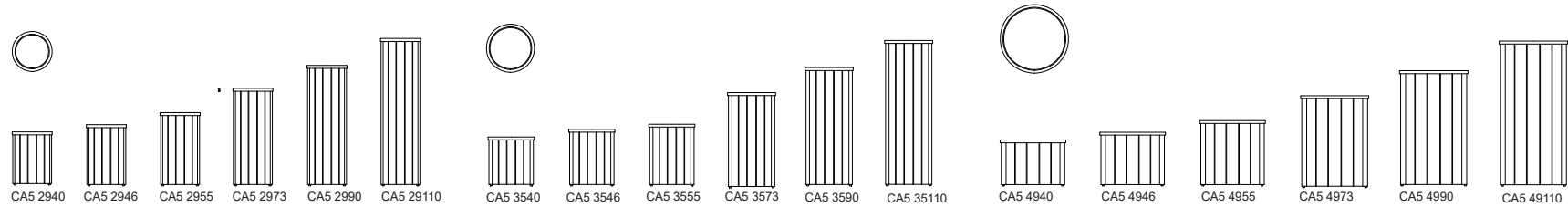

Artno	Diam mm	Höjd Height mm	Cap Podium SEK	Extra SEK		Vikt netto Weight net kilos	Vikt brutto Weight gross kilos	Volym Volume
			Top Massiv solid wood Pelare Pedestal .10 ek oak .20 björk birch .30 ask ash .50 lack color	Standardbets på ask skiva Standard stain on ash top Vitpigment ek ask White glazed oak ash	Standardbets på ask pelare Standard stain on ash pedestal Vitpigment ek ask White glazed oak ash			
CA5 2940	290	395	7820	+380	+760	8	12	0,04
CA5 2946	290	455	7820	+380	+760	8	12	0,05
CA5 2955	290	545	7820	+380	+760	9	13	0,08
CA5 2973	290	725	9970	+380	+760	12	16	0,08
CA5 2990	290	895	11210	+380	+760	14	18	0,1
CA5 29110	290	1095	11210	+380	+760	16	20	0,12
CA5 3540	350	380	10410	+510	+950	8	12	0,07
CA5 3546	350	440	10410	+510	+950	10	14	0,08
CA5 3555	350	530	10410	+510	+950	10	14	0,09
CA5 3573	350	710	12080	+510	+950	11	15	0,12
CA5 3590	350	880	13620	+510	+950	18	22	0,15
CA5 35110	350	1080	13620	+510	+950	20	24	0,18
CA5 4940	490	355	13550	+540	+1140	21	25	0,17
CA5 4946	490	415	13550	+540	+1140	22	26	0,18
CA5 4955	490	505	13550	+540	+1140	22	26	0,19
CA5 4973	490	685	15120	+540	+1110	23	27	0,22
CA5 4990	490	855	16680	+540	+1300	27	31	0,27
CA5 49110	490	1080	16680	+540	+1300	29	33	0,33
Tillbehör Accessories								
TKB11C	57		1920 svart black					
TKB12C	57		2280 svart black					

Tillbehör Accessories

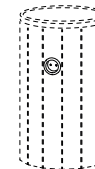

TKB11C

**Powerdot Mini. Placeras i pelare. 1 eluttag, svart, 1,5m kabel. Gäller för SE,NO,DK,FIN,DE,NL.**  
Powerdot Mini. Placed in the pedestal. 1 electrical black, 1,5m cable. For SE,NO,DK,FIN,DE,NL

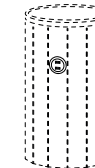

TKB12C

**Powerdot Mini. Placeras i pelare. USB A laddare inkl. 2 portar, svart, 1,5m kabel. Gäller för SE,NO,DK,FIN,DE,NL.**  
Powerdot Mini. Placed in the pedestal. USB A charging incl. 2 ports, black, 1,5m cable. For SE,NO,DK,FIN,DE,NL

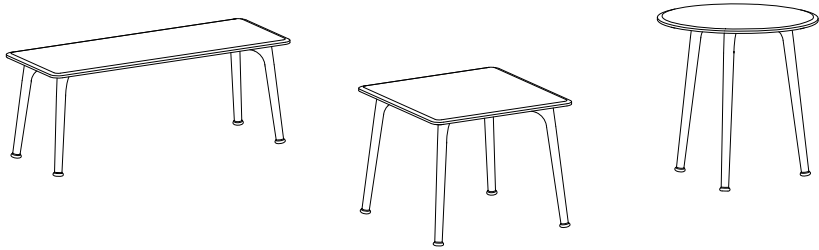

### Bord.

Skiva och ben i massiv trä i ek, björk, ask, standardfärger, standardbetser på ask och vitpigment på ek eller ask. Bordsskiva i standardfärg/lack tillverkas i MDF. Ytbehandling klarlack. Filtass är monterad under ben. Specialmått och andra utförande efter förfrågan. Bordet levereras omonterat. Benen skruvas fast under bordsskivan. Vid order ange höjd.

### Table.

Top and leg in solid wood in oak, birch, ash, standard colors, standard stains on ash or white glazed on oak or ash. Table top in standard colors are made in MDF. Finish clear lacquer. Felt floor protection under the legs. Special sizes or finishes upon request. The table comes unmounted. The legs are screwed under the table top. When ordering state height.

### Artno

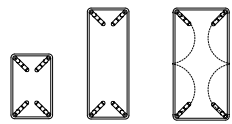

BA17045 BA112045 BA112060

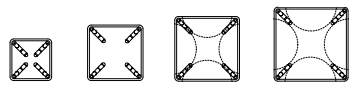

BA245 BA260 BA270 BA280



H470/570



BA350 BA360 BA370 H720 BA380 BA390 BA3100

Artno	Längd Length mm	Bredd Width mm	Diameter mm	Höjd Height mm	Bat SEK		Extra SEK		
					.10 ek oak .20 björk birch .30 ask ash	.50 lack color	Standardbets på ask Standard stain on ash Vitpigment ek ask White glazed oak ash	Vikt brutto Weight gross kilos	Volym Volume
<b>Rektangulär Rectangulare</b>									
BA17045	700	450		470,570	8680	7820	+1310	7	0,04
BA112045	1200	450		470,570	9920	8310	+1520	15	0,06
BA112060	1200	600		470,570	10830	8760	+1750	18	0,08
BA112060	1200	600		720	11710	9640	+1750	20	0,1
<b>Kvadratisk Square</b>									
BA245	450	450		470,570	7870	7280	+1200	8	0,04
BA260	600	600		470,570	8940	7880	+1350	10	0,05
BA270	700	700		470,570	9620	8170	+1450	12	0,07
BA270	700	700		720	10530	9040	+1450	14	0,09
BA280	800	800		470,570	10460	8630	+1710	16	0,08
BA280	800	800		720	11340	9520	+1710	18	0,1
<b>Rund Round</b>									
BA350			ø500	470,570	6920	6190	+1040	7	0,04
BA360			ø600	470,570	7660	6520	+1180	9	0,05
BA370 4ben/legs			ø700	470,570	9730	8170	+1360	11	0,07
BA370 3ben/legs			ø700	720	9020	7480	+1360	13	0,09
BA380			ø800	470,570	10490	8630	+1720	14	0,08
BA380			ø800	720	11370	9520	+1720	16	0,1
BA390			ø900	470,570	11170	9010	+1830	15	0,09
BA390			ø900	720	12050	9900	+1830	17	0,1
BA3100			ø1000	470,570	12330	9560	+2000	18	0,1
BA3100			ø1000	720	13190	10460	+2000	20	0,12

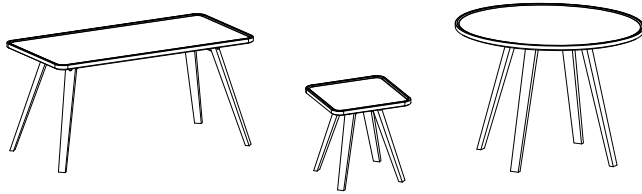

**Bord.**

Skiva och ben i massiv trä ek, björk, ask, standardfärger, standardbetser på ask och vit pigment på ek eller ask. Bordsskiva i standardfärg/lack tillverkas i MDF. Ytbehandling klar-lack. Specialmått och andra utförande efter förfrågan. Bordet levereras omonterat. Benen skruvas fast under bordsskivan. Vid order ange höjd.

**Table.**

Top and leg in solid wood of oak, birch, ash, standard colors, standard stains on ash and white glazed on oak or ash. Table top in standard colors are made in MDF. Specials sizes and other finishes upon request. The table comes unmounted. The legs are screwed under the table top. When ordering state height.

Artno

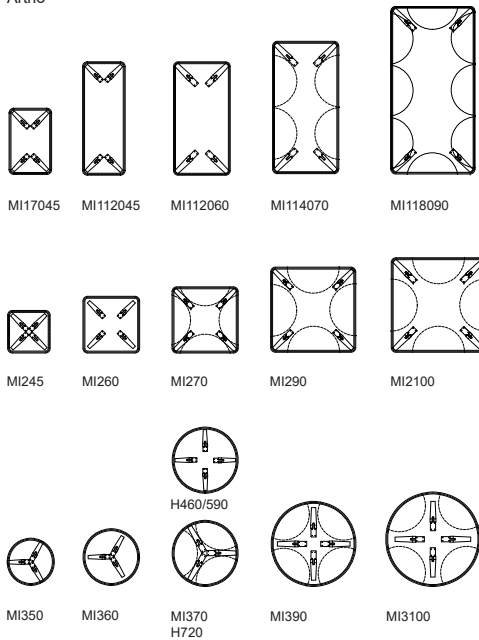

Artno	Längd Length mm	Bredd Width mm	Diameter mm	Höjd Height mm	MILL SEK		Extra SEK		
					.10 ek oak .20 björk birch .30 ask ash	.50 lack color	Standardbets på ask Standard stain on ash Vitpigment ek ask White glazed oak ash	Vikt brutto Weight gross kilos	Volym Volume
<b>Rektangulär Rectangulare</b>									
MI17045	700	450		460,590	9090	8450	+1370	10	0,04
MI112045	1200	450		460,590	11600	10270	+1690	16	0,06
MI112060	1200	600		460,590	13300	11370	+2010	24	0,08
MI112060	1200	600		720	14100	12250	+2010	26	0,1
MI114070	1400	700		460,590	16240	13610	+2570	28	0,1
MI114070	1400	700		720	17090	14540	+2570	30	0,12
MI118090	1800	900		720	23490	16540	+3540	43	0,13
<b>Kvadratisk Square</b>									
MI245	450	450		460,590	7700	7420	+1110	8	0,04
MI260	600	600		460,590	9710	8980	+1380	12	0,05
MI270	700	700		460,590	11000	9870	+1810	15	0,06
MI270	700	700		720	11810	10790	+1810	17	0,08
MI290	900	900		460,590	14560	12190	+2300	24	0,08
MI290	900	900		720	15350	13120	+2300	26	0,1
MI2100	1000	1000		460,590	16190	13820	+2570	30	0,1
MI2100	1000	1000		720	17020	14740	+2570	32	0,12
<b>Rund Round</b>									
MI350			ø500	460	7170	6540	+1080	8	0,04
MI360			ø600	460,590	8540	7700	+1270	8	0,04
MI370 4ben/legs			ø700	460,590	11000	9870	+1570	15	0,06
MI370 3ben/legs			ø700	720	10460	9290	+1570	17	0,08
MI390			ø900	460,590	14560	12190	+2300	21	0,08
MI390			ø900	720	15350	13120	+2300	23	0,1
MI3100			ø1000	460,590	16190	13820	+2570	27	0,1
MI3100			ø1000	720	17020	14740	+2570	30	0,12



## MOPSY Markus Johansson 2016



MP1  
Totale L706 W462



MP2  
Totale L968 W598

**Soffbord.** Massiv trä, klarlack.  
Ange utförande på stativ och respektive skiva.  
Bord levereras monterat.

**Sofa table.** Solid wood, clear lacquer.  
State when ordering finish of legs and each tops.  
Table comes pre-assembled.

Artno	Längd Length mm	Bredd Width mm	Diam mm	Höjd Height mm	Mopsy SEK		Vikt brutto Weight gross kilos	Volym Volume	
					.10 ek oak .20 björk birch .30 ask ash .50 lack color	Standardbets på ask per skiva Standard stain on ash each top Vitpigment ek ask per skiva White pigment oak ash each top			
MP1	370	370	462	472/422	8010	+380	+400	14	0,20
MP2	518	518	598	500/450	9560	+400	+480	15	0,35

## EIGHT Louise Hederström 2018



EI24



EI46



EI62

**Soffbord.** Massiv trä, klarlack.  
Filttass. Vid lack är skivan MDF.  
Bord levereras monterat.

**Sofa table.** Solid wood, clear lacquer.  
Felt floor protection. When lacquering top in MDF.  
Table comes pre-assembled.

Artno	Längd Length mm	Bredd Width mm	Höjd Height mm	Eight SEK		Vikt brutto Weight gross kilos	Volym Volume	
				.10 ek oak .20 björk birch .30 ask ash	.50 lack color			
EI24	352	352	530	4900	4320	+730	4	0,12
EI46	454	454	575	5440	4460	+810	4,5	0,17
EI62	600	600	480	6210	4610	+940	7	0,19

## PUDDLE Anton Björnsing 2017



PU510



PU520



PU530

**Soffbord.** Massiv trä, klarlack.  
Filttass. Vid lack är skivan MDF.  
Bordet levereras omonterat.  
Vid order ange höjd på bordet.

**Sofa table.** Solid wood, clear lacquer.  
Felt floor protection. When lacquering top in MDF.  
Table comes unmounted.  
State when ordering height of table.

Artno	Längd Length mm	Bredd Width mm	Höjd Height mm	Puddle SEK		Vikt brutto Weight gross kilos	Volym Volume	
				.10 ek oak .20 björk birch .30 ask ash	.50 lack color			
PU510	450	410	380,450,520,590	7760	7260	+1140	10	0,04
PU520	550	500	380,450,520,590	8840	7750	+1330	12	0,04
PU530	720	660	380,450,520,590	10030	8300	+1510	14	0,06

# TERRANE

Nestor Campus 2020

**Soffbord.** Massiv trä, klarlack.  
Bordet är försett med tassar.  
Bordet levereras monterat.  
Vid order ange höjd på bordet.

**Sofa table.** Solid wood, clear lacquer.  
Legs included felt protection.  
Table comes mounted.  
State when ordering height of table.



Slät Flat top  
TN345xx1 = ø450  
TN373xx1 = ø730



Två nivåer Two levels  
TN345xx2 = ø450



Tre nivåer Three levels  
TN345xx3 = ø450  
TN373xx3 = ø730

Artno	Diameter mm	Höjd Height mm	Terrane SEK	Extra SEK	Vikt brutto Weight gross kilos	Volym Volume
			.10 ek oak .20 björk birch .30 ask ash	Standardbets på ask Standard stain on ash Vitpigment ek ask White glazed oak ash		
<b>SLÄT TOP FLAT TOP</b>						
TN3 45331	ø450	330	5200	+770	5	0,09
TN3 45451	ø450	450	5200	+770	6	0,13
TN3 45571	ø450	570	5200	+770	6	0,16
TN3 73331	ø730	330	6340	+950	12	0,22
TN3 73451	ø730	450	6340	+950	13	0,3
TN3 73571	ø730	570	6340	+950	13	0,33
<b>TVÅ NIVÅER TWO LEVELS</b>						
TN3 45332	ø450	330	6440	+960	6	0,09
TN3 45452	ø450	450	6440	+960	7	0,13
TN3 45572	ø450	570	6440	+960	7	0,16
<b>TRE NIVÅER THREE LEVELS</b>						
TN3 45333	ø450	330	7440	+1120	6	0,09
TN3 45453	ø450	450	7440	+1120	7	0,13
TN3 45573	ø450	570	7440	+1120	7	0,16
TN3 73333	ø730	330	9060	+1360	13	0,22
TN3 73453	ø730	450	9060	+1360	14	0,3
TN3 73573	ø730	570	9060	+1360	14	0,33

## Soff/Brickbord.

**L = Metallstativ lackat i standardfärger.**

**M = Metallstativ mattkrom.**

Tråringar formpressade i ek eller ask, standardbets på ask och vitpigmenterad ek, ask.

Runda skivor fanerad MDF i ek, ask, vit och svart laminat, standardbets på ask och vitpigmenterad på ek eller ask.

## Tillbehör:

Handtag lindat i Tärnslö läder col. 8175 svart eller col. 8695 brun.

Dolda hjul 4 stycken som monteras i nedersta brickan, ej låsbara.

Ange vid beställning artikelnummer, utförande på ring, skiva och metallstativ.

## Sofa/Tray table.

**L = Metal frame painted in standard colors.**

**M = Metal frame in matt chrome.**

The wooden rings are available in compression-moulded oak or ash, standard stains on ash and white-glazed oak or ash.

The round trays are in MDF, veneered with oak, ash, with white and black laminate, in standard stains on ash or white glazed oak or ash.

## Accessories:

Concealed four castors that can be fitted to the lower tray, not lockable.

Handles wrapped in black (col. 8175) or brown (col. 8695) leather from Tärnslö.

When ordering please enter article number and choice of finish for ring, tray and metal frame.



TR340L  
TR340M  
ø400 H 450



TR350L  
TR350M  
ø500 H 520

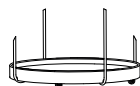

TRH  
Hjul 4st ej låsbara, +H10mm  
Castors 4pcs not lockable, +H10mm

Artno	Diameter mm	Höjd Height mm	Trayo SEK		Extra SEK		
			.10 ek oak .60 ek/vit laminat oak/white laminate .61 ek/svart laminat oak/black laminate	.30 ask ash .62 ask/vit laminat ash/white laminate .63 ask/svart laminat ash/black laminate	Standardbets på ask Standard stain on ash Vitpigment ek ask White glazed oak ash	Vikt brutto Weight gross kilos	Volym Volume
<b>Metallstativ lackat i standardfärger Metal frame painted in standard colors</b>							
TR340L	ø400	450	7030	6220	+590	5	0,1
TR350L	ø500	520	8000	6930	+700	6	0,17
<b>Metallstativ mattkrom Metal frame matt chrome</b>							
TR340M	ø400	450	7030	6220	+590	5	0,1
TR350M	ø500	520	8000	6930	+700	6	0,17
<b>Tillbehör Accessories</b>							
			<b>Tillbehör Accessories SEK</b>				
TRH Hjul, ej låsbara Castors, not lockable		+10	+1470				
TRL40-1 Handtag svart läder ø400 Handle black leather ø400			+2230				
TRL40-2 Handtag brunt läder ø400 Handle brown leather ø400			+2230				
TRL50-1 Handtag svart läder ø500 Handle black leather ø500			+2500				
TRL50-2 Handtag i brunt läder ø500 Handle in brown leather ø500			+2500				

## TRIO Ulla Christiansson 1998

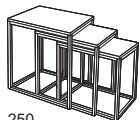

**Satsbord.** Massiv trä, klarlack.  
Bord levereras monterat.

**Nest of tables.** Solid wood, clear lacquer.  
Table comes pre-assembled.

250

Artno	Längd Length mm	Bredd Width mm	Höjd Height mm	Trio SEK			Extra SEK		Vikt brutto Weight gross kilos	Volym Volume
				.10 ek oak .30 ask ash	.15 bok beech .20 björk birch	.43 körsbär cherry	Olja Oil	Olja+lack Oil+clear lacquer Standardbets på ask Standard stain on ash Vitpigment ek, ask White glazed oak or ash		
250	440/420/400	340/290/240	580/555/530	10030	9580	11120	+1000	+1510	10	0,13

## NEWTON Dan Sunaga Staffan Holm 2009



NW1597



NW2592

**Soffbord.** Glasskiva triellips.  
Underrede trä, klarlack. Underredet levereras monterat  
och glasskivan ligger löst på underredet.

**Sofa table.** Glass top. Base in wood,  
clear lacquer. The base comes pre-assembled and glass  
top is loose on the base.

Artno	Diam mm	Höjd Height mm	Newton SEK		Extra SEK		
			.10 ek oak	.20 björk birch .30 ask ash	Standardbets på ask Standard stain on ash Vitpigment ek ask White glazed oak ash	Vikt brutto Weight gross kilos	Volym Volume
NW1597	ø970	cirka approx ~ 300	13770	11850	+1750	25	0,35
NW2592	ø920	cirka approx ~ 390	13450	11490	+1730	25	0,35

# SHELL PALL STOOL

Note 2015



## SHPxxT

Träsits. Ben i massiv trä, klarlack. Filttass.

## SHPxxT

Wooden seat. Legs in solid wood, clear lacquer. Felt floor protection.

## SHPxxK

Klädd sits. Ben i massiv trä, klarlack. Filttass.  
Stafflad prisskala avser samma färg på tyg och träslag.  
För mönsterpassat tyg återkom för prisuppgift.

## SHPxxK

Seat upholstered. Legs in solid wood, clear lacquer. Felt floor protection.  
Staffed price scale refers to the same color of fabric and wood.  
For patterned fabric returned for price information.

Artno



SHP45T  
SHP45K

SHP70T  
SHP70K

SHP80T  
SHP80K

### Shell pall stool SEK

Artno	Bredd Width mm	Djup Depth mm	Höjd Height mm	Shell pall stool SEK		Extra SEK		Vikt netto Weight net kilos	Vikt brutto Weight gross kilos	Volym Volume
				.10 ek oak .20 björk birch .30 ask ash	.50 lack color	Standardbets på ask Standard stain on ash	Vitpigment ek ask White glazed oak ash			
<b>Träsits Wooden seat</b>										
SHP45T	370	413	450	4230	4640	+640		2,4	6	0,1
SHP70T	370	413	650	4540	4950	+690		2,8	7	0,15
SHP80T	370	413	800	4820	5260	+720		3,3	8	0,18

### Shell pall stool SEK

Artno	Bredd Width mm	Djup Depth mm	Höjd Height mm	Shell pall stool SEK						Extra SEK		Vikt netto Weight net kilos	Vikt brutto Weight gross kilos	Volym Volume
				.10 ek oak .20 björk birch .30 ask ash	.10 ek oak .20 björk birch .30 ask ash	.10 ek oak .20 björk birch .30 ask ash	.50 lack color	.50 lack color	.50 lack color	Standardbets på ask Standard stain on ash	Tygåtgång på 140 cm bredd Requirement of fabric width 140 cm			
<b>Klädd sits exkl. tyg eller läder Upholstered seat excl. fabric or leather</b>				<b>1 styck pc</b>	<b>2-10 styck pc</b>	<b>11- styck pc</b>	<b>1 styck pc</b>	<b>2-10 styck pc</b>	<b>11- styck pc</b>	<b>per styck pc</b>				
SHP45K	370	413	450	5140	4670	4460	5900	4930	4810	+600	50x90 cm	2,4	6	0,1
SHP70K	370	413	650	5420	4940	4760	6220	5260	5140	+650	50x90 cm	2,8	7	0,15
SHP80K	370	413	800	5690	5230	5060	6520	5550	5420	+700	50x90 cm	3,3	8	0,18

Extra Tyg Läder, Fabric Leather

SEK/styck pc	1 styck pc	2-10 styck pc	11- styck pc
Prisgrupp Pricegroup 1	+990	+740	+520
Prisgrupp Pricegroup 2	+1040	+810	+570
Prisgrupp Pricegroup 3	+1110	+900	+650
Prisgrupp Pricegroup 4	+1270	+1090	+810
Standard läder leather	+990	+990	+990

**MLPxxTTF** Sits och ben i massiv trä, klarlack. Filttass.  
**MLPxxTTFR** Rygg i trä. Sits och ben i massiv trä, klarlack. Filttass.

**MLPxxTTF** Seat and legs in solid wood, clear lacquer. Felt floor protection.  
**MLPxxTTFR** Back in wood. Seat and legs in solid wood, clear lacquer. Felt floor protection.

**MLPxxTKF** Klädd dyna. Sits och ben i massiv trä, klarlack. Filttass.  
**MLPxxTKFR** Rygg i trä. Klädd dyna. Sits och ben i massiv trä, klarlack. Filttass  
 Stafflad prisskala avser samma färg på tyg och träslag. För mönsterpassat tyg återkom för prisuppgift.

**MLPxxTKF** Cushion upholstred. Seat and legs in solid wood, clear lacquer. Felt floor protection.  
**MLPxxTKFR** Back in wood. Cushion upholstred. Seat and legs in solid wood, clear lacquer. Felt floor protection.  
 Staffed price scale refers to the same color of fabric and wood. For patterned fabric returned for price information.



Artno	Bredd Width mm	Djup Depth mm	Höjd Height mm	Sitthöjd Seat height mm	Milo SEK		Extra SEK						
					.10 ek oak .30 ask ash	Standardbets på ask Standard stain on ash  Vitpigment ek ask White glazed oak ash	Snurrfunktion max 130kg Swivel max 130kg	Fotplåt Foot rest MLPFPs = svart black MLPFPv = vit white	Fotplåt Foot rest MLPFPr = rostfri stål stainless steel	Vikt netto Weight net kilos	Vikt brutto Weight gross kilos	Volym Volume	
<b>Träsits Wooden seat</b>													
MLP65 TTF	350	350 ø390	650		5020	+760	+140	+530	+650	6	10	0,12	
MLP75 TTF	350	350 ø390	750		5080	+760	+140	+530	+650	6	10	0,17	
<b>Rygg. Träsits. Back. Wooden seat.</b>													
MLP65 TTFR	350	350 ø390/370	870	650	6760	+1010	+140	+530	+650	7	11	0,15	
MLP75 TTFR	350	350 ø390/370	970	750	6820	+1010	+140	+530	+650	7	11	0,20	

Artno	Bredd Width mm	Djup Depth mm	Höjd Height mm	Sitthöjd Seat height mm	Milo SEK			Extra SEK							
					.10 ek oak .30 ask ash	.10 ek oak .30 ask ash	.10 ek oak .30 ask ash	Standardbets på ask Standard stain on ash  Vitpigment ek ask White glazed oak ash	Snurrfunktion max 130kg Swivel max 130kg	Fotplåt Foot rest MLPFPs = svart black MLPFPv = vit white	Fotplåt Foot rest MLPFPr = rostfri stål stainless steel	Tygåtgång på 140 cm bredd Requirement of fabric width 140 cm	Vikt netto Weight net kilos	Vikt brutto Weight gross kilos	Volym Volume
<b>Klädd dyna exkl. tyg eller läder Upholstred cushion excl. fabric or leather</b>															
MLP65 TKF	350	350 ø390	650		5980	5930	5800	+760	+140	+530	+650	50 cm	6	10	0,12
MLP75 TKF	350	350 ø390	750		6040	5980	5850	+760	+140	+530	+650	50 cm	6	10	0,17
<b>Rygg. Klädd dyna exkl. tyg eller läder Back. Upholstred cushion, excl. fabric or leather</b>															
MLP65 TKFR	350	350 ø390/370	870	650	7730	7660	7540	+1010	+140	+530	+650	50 cm	7	11	0,15
MLP75 TKFR	350	350 ø390/370	970	750	7790	7730	7610	+1010	+140	+530	+650	50 cm	7	11	0,20

**Extra Tyg Läder, Fabric Leather**

SEK/styck pc	1 styck pc	2-10 styck pc	11- styck pc
Prisgrupp Pricegroup 1	+990	+650	+310
Prisgrupp Pricegroup 2	+1040	+700	+340
Prisgrupp Pricegroup 3	+1110	+780	+380
Prisgrupp Pricegroup 4	+1270	+940	+470
Standard läder leather	+420	+420	+420

**Pall**  
Sits i massiv trä, klarlack. Ben i metall, ytbehandling i  
\*mattkrom eller \*\*svartlack. Filttass.

**Stool**  
Seat in solid wood, clear lacquer. Legs in metal, finish  
\*matchchrome or \*\*black lacquer. Felt floor protection.

Artno



KAZP45M\*  
KAZP45S\*\*



KAZP65M\*  
KAZP65S\*\*



KAZP80M\*  
KAZP80S\*\*

Artno	Bredd Width mm	Djup Depth mm	Höjd Height mm	Kaz SEK	Extra SEK	Vikt netto Weight net kilos	Vikt brutto Weight gross kilos	Volym Volume
				.10 ek oak .30 ask ash	Standardbets på ask Standard stain on ash  Vitpigment ek, ask White glazed oak, ash			
KAZP45M	440	365	450	4110	+350	4	6	0,1
KAZP45S	440	365	450	4110	+350	4	6	0,1
KAZP65M	440	405	650	4420	+350	5	8	0,15
KAZP65S	440	405	650	4420	+350	5	8	0,15
KAZP80M	440	405	800	4580	+350	6	9	0,18
KAZP80S	440	405	800	4580	+350	6	9	0,18

# COLO CHAIR kaschkasch 2022



Den flexibla och fällbara stolen Colo Chair är stativet i massivt trä med formpressad sits och rygg i trä. Samtliga beslag är i rostfritt stål. Träslagen är ek, ask, standardbetsler på ask och vitpigmenterad ek eller ask. Benen är försedd med filtassar. Som tillval finns klädd dyna i tyg eller läder, kopplingsbeslag och upphängningsbeslag i massivträ lika utförande som stolen. Maxantal två stycken per upphängningsbeslag. Transportvagn med låsbara hjul och metallhandtag i svart finns för 12 stolar. I hopfällt läge är staplingsmättet är 72 mm. Med hjälp av handverktyg är det enkelt att separera alla delar av stolen.

The flexible and folding Colo Chair is made in solid wood frame supports a compression-pressed wooden seat and backrest. All fittings are made of stainless steel. Choose from oak or ash, standard stains on ash, or white glaze on oak or ash. The legs have felt floor protectors. Optional extras are seat pads covered in fabric or leather, link fittings and solid wood suspension brackets in the same finish as the chair. Maximum two chairs per bracket. A trolley in a black finish with metal handles and locking wheels is also available for storing and transporting up to 12 chairs. Each chair folds to a maximum of 72 mm. The appropriate hand tools are all that is required to simply separate each chair into its component parts.

## Tillbehör Accessories

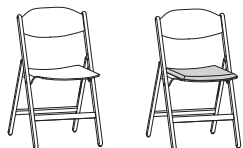

CC1

CC2



CCU2  
D160 ø38  
Upph.beslag max 2 stolar  
Suspen.bracket max. 2 chairs

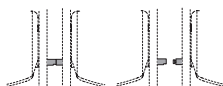

CCK  
Koppl.beslag distans 40mm  
rostfri  
Link fittings distance 40mm  
stainless

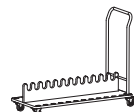

CCV1  
Vagn max 12 stolar, svart  
Trolley max 12 chairs, black

Artno	Bredd Width mm	Djup Depth mm	Höjd Height mm	Sitthöjd Seat Height mm	Colo Chair SEK		Extra SEK			
					.10 ek oak	.30 ask ash	Standardbets på ask Standard stain on ash	Vikt netto Weight net kilos	Vikt brutto Weight gross kilos	Volym Volume
<b>Träsits Wooden seat</b>										
CC1	460	540	815	465	4130	3900	+580	3,4	5	0,05
Tillbehör Accessories for CC1 and CC2										
CCU2		160/ø38			510	510	+70			
CCK rostfri stainless	40				330 rostfri stainless					
CCV1 svart black	500	1250	1015		6360 svart black					

Artno	Bredd Width mm	Djup Depth mm	Höjd Height mm	Sitthöjd Seat Height mm	Colo Chair SEK						Extra SEK				
					.10 ek oak	.10 ek oak	.10 ek oak	.30 ask ash	.30 ask ash	.30 ask ash	Standardbets på ask Standard stain on ash	Tygåtgång på 140 cm bredd Requirement of fabric width 140 cm	Vikt netto Weight net kilos	Vikt brutto Weight gross kilos	Volym Volume
<b>Klädd sits exkl. tyg eller läder Upholstred seat excl. fabric or leather</b>															
CC2	460	540	815	480	1 pc	2-10 pc	11- pc	1 pc	2-10 pc	11- pc	+580	50x45 cm	4,3	6	0,06

SEK/styck pc	1 styck pc	2-10 styck pcs	11- styck pcs
Prisgrupp Pricegroup 1	+990	+500	+210
Prisgrupp Pricegroup 2	+1040	+520	+220
Prisgrupp Pricegroup 3	+1110	+560	+250
Prisgrupp Pricegroup 4	+1270	+640	+310
Standard läder leather	+520	+520	+520



# SHELL STOL CHAIR Note 2018



## SHST45T träsis.

Ben i massiv trä, klarlack inkl. filltass.

## SHST45S klädd sits.

Ben i massiv trä, klarlack inkl. filltass.  
Stafflad prisskala avser samma färg på tyg och träslag.  
För mönsterpassat tyg återkom för prisuppgift.

## SHST45K klädd sits och rygg.

Ben i massiv trä, klarlack inkl. filltass.  
Stafflad prisskala avser samma färg på tyg och träslag.  
För mönsterpassat tyg återkom för prisuppgift.

Legs in solid wood incl. felt floor protection. Clear lacquer.  
Staffed price scale refers to the same color of fabric and wood.  
For patterned fabric returned for price information.

Legs in solid wood incl. felt floor protection. Clear lacquer.  
Staffed price scale refers to the same color of fabric and wood.  
For patterned fabric returned for price information.

Artno



SHST45T



SHST45S



SHST45K

Shell stol chair SEK			Extra SEK	
----------------------	--	--	-----------	--

Artno	Bredd Width mm	Djup Depth mm	Höjd Height mm	Sithöjd Seat Height mm	.10 ek oak	.20 björk	.50 lack color	Standardbets på ask Standard stain on ash	Vikt netto Weight net kilos	Vikt brutto Weight gross kilos	Volym Volume
					.30 ask ash	birch					
<b>Träsits Wooden seat</b>											
SHST45T	405	525	825	455	5220	4640	5070	+770	4	6	0,28

Shell stol chair SEK													Extra SEK		
----------------------	--	--	--	--	--	--	--	--	--	--	--	--	-----------	--	--

Artno	Bredd Width mm	Djup Depth mm	Höjd Height mm	Sithöjd Seat Height mm	.10 ek oak	.10 ek oak	.10 ek oak	.20 björk	.20 björk	.20 björk	.50 lack color	.50 lack color	.50 lack color	Standardbets på ask Standard stain on ash	Tygätgång på 140 cm bredd Requirement of fabric width 140 cm	Vikt netto Weight net kilos	Vikt brutto Weight gross kilos	Volym Volume
					.30 ask ash	.30 ask ash	.30 ask ash	birch	birch	birch	color	color	color					
<b>Klädd sits exkl. tyg eller läder Upholstred seat excl. fabric or leather</b>																		
					<b>1 pc</b>	<b>2-10 pc</b>	<b>11- pc</b>	<b>1 pc</b>	<b>2-10 pc</b>	<b>11- pc</b>	<b>1 pc</b>	<b>2-10 pc</b>	<b>11- pc</b>	<b>per styck pc</b>				
SHST45S	405	525	825	455	6510	6470	6330	5930	5880	5770	6340	6310	6190	+770	50x46 cm	5	7	0,28
<b>Klädd sits och rygg exkl. tyg eller läder Fully upholstred excl. fabric or leather</b>																		
SHST45K	405	525	825	455	7910	6640	6430	7790	6520	6320	8030	6770	6580	+340	75 cm	4	6	0,28

### Extra Tyg Läder, Fabric Leather SHST45S klädd sits upholstred seat

SEK/styck pc	1 styck pc	2-10 styck pcs	11- styck pcs
Prisgrupp Pricegroup 1	+990	+500	+210
Prisgrupp Pricegroup 2	+1040	+520	+220
Prisgrupp Pricegroup 3	+1110	+560	+250
Prisgrupp Pricegroup 4	+1270	+640	+310
Standard läder leather	+550	+550	+550

### Extra Tyg Läder, Fabric Leather SHST45K klädd sits och rygg fully upholstred

SEK/styck pc	1 styck pc	2-10 styck pcs	11- styck pcs
Prisgrupp Pricegroup 1	+1220	+980	+760
Prisgrupp Pricegroup 2	+1300	+1050	+850
Prisgrupp Pricegroup 3	+1420	+1170	+960
Prisgrupp Pricegroup 4	+1650	+1410	+1210
Standard läder leather	+2250	+2250	+2250

### Pall.

Underrede och ben i massiv trä inkl. fylltassar. Ytbehandling klarlack.  
 Stoppning kallskum klädd exkl. tyg/läder. Tillbehör bord diam 260mm och USB.  
 Pall levereras monterad. Vid beställning ange artikelnummer, utförande och klädsel.

### Stool.

Base in solid wood incl. felt protection. Finish clear lacquer.  
 Upholstered excl. fabric/leather. Seat in cold-cured foam.  
 The stool comes pre-assembled. When ordering article number, execution and name of fabric/leather.

### Artno



HY370



HY390



HY3120

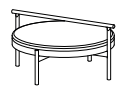

HY390-A  
incl. armstöd/rygg  
armrest/back

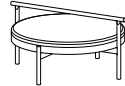

HY3120-A  
incl. armstöd/rygg  
armrest/back

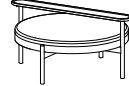

HY3120-5  
incl. långt bord  
long table

### Tillbehör / Accessories



Bord Table diam 260mm  
 Antal bord per pall/artno  
 Numbers of table per stool/art.no

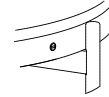

TKB18 USB  
 Svart. Placeras på ramen vid sidan av ben.  
 Black. Placed on the side of the leg.

HY370-1 = 1st pc HY370  
 HY390-1 = 1st pc HY390  
 HY390-2 = 2st pc HY390  
 HY3120-1 = 1st pc HY3120  
 HY3120-2 = 2st pc HY3120  
 HY3120-3 = 3st pc HY3120  
 HY3120-4 = 4st pc HY3120

Hygge SEK	Extra SEK
-----------	-----------

Artno	Diam mm	Höjd Height mm	.10 ek oak .30 ask ash	Standardbets på ask Standard stain on ash Vitpigment ek ask White glazed oak ash	Tyg Fabric Prisgrupp Pricegroup 1	Tyg Fabric Prisgrupp Pricegroup 2	Tyg Fabric Prisgrupp Pricegroup 3	Tyg Fabric Prisgrupp Pricegroup 4	Standard läder Leather	Tygåtgång på 140 cm bredd Requirement of fabric width 140 cm	Vikt brutto Weight gross kilos	Volym Volume
HY370	780/700	460	10380	+1560	+1370	+1460	+1600	+1890	+1630	90 cm	35	0,45
HY390	980/900	460	11500	+1730	+1560	+1670	+1840	+2190	+2150	110 cm	55	0,8
HY3120	1280/1200	460	12990	+1950	+1840	+1990	+2220	+2660	+4120	140 cm	70	1,09
HY390-A	980/900 Armstöd/Armrest H680 L1080 ø40	460	13630	+2060	+1560	+1670	+1840	+2190	+2150	110 cm	71	1,2
HY3120-A	1280/1200 Armstöd/Armrest H680 L1380 ø40	460	14990	+2250	+1840	+1990	+2220	+2660	+4120	140 cm	71	1,2
HY3120-5	1280/1200 Långt bord/Long table H680 L1140 W195	460	17460	+2620	+1840	+1990	+2220	+2660	+4120	140 cm	76	1,2
<b>Tillbehör Accessories</b>												
HY370-1	Bord Table diam 260	680	1980	+200								
HY390-1	Bord Table diam 260	680	1980	+200								
HY390-2	Bord Table diam 260	680	3950	+390								
HY3120-1	Bord Table diam 260	680	1980	+200								
HY3120-2	Bord Table diam 260	680	3950	+390								
HY3120-3	Bord Table diam 260	680	5940	+590								
HY3120-4	Bord Table diam 260	680	7910	+780								
TKB18	USB svart black		980 svart black									

## Sander Conference

Träslag: ek, ask, standardbetser på ask och vitpigmenterad ek eller ask.

Underrede: Ben i massiv trä inkl. filttass.

4-kryssföt i metall i färg svart pulverlack eller mattpolerad, sits alltid höj- och sänkbar och snurrbar. Filttass för hårda ytor eller plaststass för mjuka ytor

Hjul ej låsbara, i färg svart pulverlack eller mattpolerad. Är snurrbar och välj mellan fast eller höj- och sänkbar sits.

Fätöj finns med eller utan armstöd. Armstöd i massivt trä.

Fätöjen sits och rygg kan kläs i tyg, läder, konstläder eller efter önskemål. Rekommendation är att välja ett tyg som är tvätt- och stretchbart. Tyger generell bör vara något tójbara. Randiga och rutiga mönster bör undvikas. Tillval: avtagbar klädsel på sits.

Fätöjen levereras monterad. Med hjälp av handverktyg är det enkelt att separera ryggskäet från benstativ och vid en eventuell omklädsel skruvas rygg och sits enkelt bort.

Ange vid beställning: artikelnummer, utförande på trä, tyg, läder samt tass för metallstativ.

## MÖBELFAKTA

### Sander Conference

Wood: oak, ash, standard stains on ash and white glazed on oak or ash.

Base: Legs in solid wood incl. felt feet.

4-star base in metal, color black powder coating or matte polished, equipped with felt feet for hard surfaces or plastic feet for soft surfaces. Adjustable height and swivel.

Wheel stand (not lockable). in black powder coating or matte polished. All chairs are swivel and choose between a fixed or adjustable height.

Sander Conference available with or without armrest. Armrest in solid wood

The seat and back may be covered in a fabric of choice or real or synthetic leather, according to customer wishes.

Fabrics should generally be somewhat stretchable. Avoid striped/checkered patterns. A removable seat cover with an interliner of hospital-grade fabric or lining cloth is available as an optional extra, recommendation is to choose a fabric that is washable and stretchable. The easy chair is supplied assembled. Hand tools are all that is needed to simply detach the back shell from the leg frame. It is a simple matter to separate seat and back, if the chair is to be re-covered.

State when ordering: article number, finish of wood, fabric, leather and feet on the 4-star base.

## Artno Sander Conference



Klädd sits.  
Upholstered seat.  
SAF500



Klädd sits, höj/sänkbar.  
Upholstered seat, adjustable height.  
SAF504s = black  
SAF504p = matt polished



Klädd sits, fast höjd.  
Upholstered seat, fixed height.  
SAF506s = black  
SAF506p = matt polished



Klädd sits, höj/sänkbar.  
Upholstered seat, adjustable height.  
SAF508s = black  
SAF508p = matt polished



Klädd sits  
Upholstered seat  
SAF600



Klädd sits, höj/sänkbar.  
Upholstered seat, adjustable height  
SAF604s = black  
SAF604p = matt polished



Klädd sits, fast höjd  
Upholstered seat, fixed height  
SAF606s = black  
SAF606p = matt polished



Klädd sits, höj/sänkbar  
Upholstered seat, adjustable height  
SAF608s = black  
SAF608p = matt polished



Klädd sits och rygg.  
Upholstered seat and back.  
SAF510



Klädd sits, höj/sänkbar.  
Upholstered seat and back, adjustable height.  
SAF514s = black  
SAF514p = matt polished



Klädd sits och rygg, fast höjd.  
Upholstered seat and back, fixed height  
SAF516s = black  
SAF516p = matt polished



Klädd sits och rygg, höj/sänkbar  
Upholstered seat and back, adjustable height.  
SAF518s = black  
SAF518p = matt polished



Klädd sits och rygg.  
Upholstered seat and back.  
SAF610



Klädd sits och rygg, höj/sänkbar  
Upholstered seat and back, adjustable height.  
SAF614s = black  
SAF614p = matt polished



Klädd sits och rygg, fast höjd.  
Upholstered seat and back, fixed height.  
SAF616s = black  
SAF616p = matt polished



Klädd sits och rygg, höj/sänkbar.  
Upholstered seat and back, adjustable height.  
SAF618s = black  
SAF618p = matt polished

### Extra Tyg Läder, Fabric Leather

Klädd sits Upholstered seat

Artno SAF500, SAF504, SAF506, SAF508, SAF600, SAF604, SAF606, SAF608

SEK/styck pcs	1 styck pc	2-10 styck pcs	11- styck pcs
Prisgrupp Pricegroup 1	+1460	+730	+410
Prisgrupp Pricegroup 2	+1570	+780	+460
Prisgrupp Pricegroup 3	+1730	+870	+520
Prisgrupp Pricegroup 4	+2050	+1030	+640
Standard läder leather	+910	+910	+910

### Extra Tyg Läder, Fabric Leather

Klädd sits och rygg Upholstered seat and back

Artno SAF510, SAF514, SAF516, SAF518, SAF610, SAF614, SAF616, SAF618

SEK/styck pcs	1 styck pc	2-10 styck pcs	11- styck pcs
Prisgrupp Pricegroup 1	+1460	+920	+720
Prisgrupp Pricegroup 2	+1570	+1000	+800
Prisgrupp Pricegroup 3	+1730	+1110	+900
Prisgrupp Pricegroup 4	+2050	+1340	+1120
Standard läder leather	+1790	+1790	+1790

Artno	Bredd Width mm	Djup Depth mm	Höjd Height mm	Sithöjd Seat height mm	Armstöd Armrest höjd height mm	Sander Conference SEK			Extra SEK			Tytgång på 140 cm bredd Requirement of fabric width 140 cm	Höj-sänkbar sits Adjustable seat	Vikt netto Weight net kilos	Vikt brutto Weight gross kilos	Volym Volume
						.10 ek oak .30 ask ash	.10 ek oak .30 ask ash	.10 ek oak .30 ask ash	Standardbets på ask Standard stain on ash Vitpigment ek ask White glazed oak ash	Avtagbar klädsel på sits, urinröv Removable cover on seat, an interliner of hospital-grade	Avtagbar klädsel på sits, domestik Removable cover on seat, lining cloth					
<b>utan armstöd excl. armrest</b>						<b>1 styck pc</b>	<b>2-10 styck pcs</b>	<b>11- styck pcs</b>	<b>per styck each</b>	<b>per styck each</b>	<b>per styck each</b>					
SAF500	550	640	820	470		9350	9150	9030	+1100	+920	+810	70 cm	---	9	13	0,34
SAF504s	550	640	800/925	415/540		10110	9910	9790	+900	+920	+810	70 cm	YES	14	18	0,33
SAF504p	550	640	800/925	415/540		10290	10090	9970	+900	+920	+810	70 cm	YES	14	18	0,33
SAF506s	550	640	850	460		10210	10010	9890	+900	+920	+810	70 cm	---	14	18	0,35
SAF506p	550	640	850	460		10570	10370	10250	+900	+920	+810	70 cm	---	14	18	0,35
SAF508s	550	640	840/965	460/585		10210	10010	9890	+900	+920	+810	70 cm	YES	14	18	0,35
SAF508p	550	640	840/965	460/585		10570	10370	10250	+900			70 cm	YES	14	18	0,35
SAF510	550	640	820	470		11310	11000	10790	+900	+920	+810	70 cm	---	9	13	0,34
SAF514s	550	640	800/925	415/540		12370	12060	11850	+850	+920	+810	70 cm	YES	14	18	0,33
SAF514p	550	640	800/925	415/540		12550	12240	12030	+850	+920	+810	70 cm	YES	14	18	0,33
SAF516s	550	640	850	460		12170	11860	11650	+850	+920	+810	70 cm	---	14	18	0,35
SAF516p	550	640	850	460		12530	12220	12010	+850	+920	+810	70 cm	---	14	18	0,35
SAF518s	550	640	840/965	460/585		12170	11860	11650	+850	+920	+810	70 cm	YES	14	18	0,35
SAF518p	550	640	840/965	460/585		12530	12220	12010	+850	+920	+810	70 cm	YES	14	18	0,35
<b>med armstöd incl. armrest</b>																
SAF600	600	640	820	470	615	10260	10060	9940	+1150	+920	+810	70 cm	---	10	14	0,34
SAF604s	600	640	800/925	415/540	560/685	11500	11300	11180	+950	+920	+810	70 cm	YES	15	19	0,33
SAF604p	600	640	800/925	415/540	580/685	11500	11300	11180	+950	+920	+810	70 cm	YES	15	19	0,33
SAF606s	600	640	850	460	605	10640	10440	10320	+950	+920	+810	70 cm	---	15	19	0,35
SAF606p	600	640	850	460	605	11480	11280	11160	+950	+920	+810	70 cm	---	15	19	0,35
SAF608s	600	640	840/965	460/585	605/730	11120	10920	10800	+950	+920	+810	70 cm	YES	15	19	0,35
SAF608p	600	640	840/965	460/585	605/730	11480	11280	11160	+950	+920	+810	70 cm	YES	15	19	0,35
SAF610	600	640	820	470	615	12220	11910	11700	+950	+920	+810	70 cm	---	10	14	0,34
SAF614s	600	640	800/925	415/540	560/685	13280	12590	12380	+900	+920	+810	70 cm	YES	15	19	0,33
SAF614p	600	640	800/925	415/540	560/685	13460	12770	12560	+900	+920	+810	70 cm	YES	15	19	0,33
SAF616s	600	640	850	460	605	13080	12770	12560	+900	+920	+810	70 cm	---	15	19	0,35
SAF616p	600	640	850	460	605	13440	13130	12920	+900	+920	+810	70 cm	---	15	19	0,35
SAF618s	600	640	840/965	460/585	605/730	13080	12770	12560	+900	+920	+810	70 cm	YES	15	19	0,35
SAF618p	600	640	840/965	460/585	605/730	13440	13130	12920	+900	+920	+810	70 cm	YES	15	19	0,35

Pris Tyg Läder | Price Fabric Leather see page 91

## Sander Lounge

Träslag: ek, ask, standardbetser på ask och vitpigmenterad ek eller ask.  
Underrede: Ben i massiv trä inkl. filtass. 4-Kryssfot i metall, färg svart pulverlack eller mattpolerad, är snurrbar och har återgång av sits. (Ej höj- och sänkbar). Kryssfot är försedd med filtass för hårda ytor eller plastass för mjuka ytor.  
Fanns med eller utan armstöd.

Fätöljens sits och rygg kan kläs i tyg, läder, konstläder eller efter önskemål. Rekommendation är att välja ett tyg som är tvätt- och stretchbart. Tyger generellt bör vara något tøjbara. Randiga och rutiga mönster bör undvikas.

Tillval: avtagbar klädsel på sits.

Fätöljen levereras monterad. Med hjälp av handverktyg är det enkelt att separera ryggskalet från benstativ och vid en eventuell omklädsel skruvas rygg och sits enkelt bort.

Ange vid beställning: artikelnummer, utförande på trä, tyg, läder samt tass för metallstativ.

## Sander Lounge

Wood: oak, ash, standard stains on ash and white glazed on oak or ash.

Base: Legs in solid wood incl. felt feet. 4-star base in metal black powder coating or matte polished, has swivel and a reversible seat, (not adjustable). The 4-star base is equipped with felt feet for hard surfaces or plastic feet for soft surfaces.

Available with or without armrest.

The seat and back may be covered in a fabric of choice or real or synthetic leather, according to customer wishes.

Fabrics should generally be somewhat stretchable. Avoid striped/checkered patterns. A removable seat cover with an interliner of hospital-grade fabric or lining cloth is available as an optional extra, recommendation is to choose a fabric that is washable and stretchable.

The easy chair is supplied assembled. Hand tools are all that is needed to simply detach the back shell from the leg frame. It is a simple matter to separate seat and back, if the chair is to be re-covered.

State when ordering: article number, finish of wood, fabric, leather and feet protection of 4-star base.

### Artno Sander Lounge



Klädd sits  
Upholstered seat  
SAF100



Klädd sits  
Upholstered seat  
SAF101s = black  
SAF101p = matt polished



Klädd sits  
Upholstered seat  
SAF200



Klädd sits  
Upholstered seat  
SAF201s = black  
SAF201p = matt polished



Klädd sits och rygg  
Upholstered seat and back  
SAF110



Klädd sits och rygg  
Upholstered seat and back  
SAF111s = black  
SAF111p = matt polished



Klädd sits och rygg  
Upholstered seat and back  
SAF210



Klädd sits och rygg  
Upholstered seat and back  
SAF211s = black  
SAF211p = matt polished

Artno	Bredd Width mm	Djup Depth mm	Höjd Height mm	Sithöjd Seat height mm	Armstöd Armrest höjd height mm	Sander Lounge SEK			Extra SEK			Tytgång på 140 cm bredd Requirement of fabric width 140 cm	Vikt netto Weight net kilos	Vikt brutto Weight gross kilos	Volym Volume
						.10 ek oak .30 ask ash	.10 ek oak .30 ask ash	.10 ek oak .30 ask ash	Standardbets på ask Standard stain on ash Vitpigment ek ask White glazed oak ash	Avtagbar klädsel på sits, urinröv Removable cover on seat, an interliner of hospital-grade	Avtagbar klädsel på sits, domestik Removable cover on seat, lining cloth				
<b>utan armstöd excl. armrest</b>						<b>1 styck pc</b>	<b>2-10 styck pcs</b>	<b>11- styck pcs</b>	<b>per styck each</b>	<b>per styck each</b>	<b>per styck each</b>				
SAF100	550	640	780	430		9300	9100	8980	+1100	+920	+810	70 cm	9	13	0,34
SAF101s	550	640	800	425		10410	10210	10090	+900	+920	+810	70 cm	14	18	0,33
SAF101p	550	640	800	425		10590	10390	10270	+900	+920	+810	70 cm	14	18	0,33
SAF110	550	640	780	430		11260	10950	10740	+900	+920	+810	70 cm	9	13	0,34
SAF111s	550	640	800	425		12370	12060	11850	+850	+920	+810	70 cm	14	18	0,33
SAF111p	550	640	800	425		12550	12240	12030	+850	+920	+810	70 cm	14	18	0,33
<b>med armstöd incl. armrest</b>															
SAF200	655	640	780	430	575	10210	10010	9890	+1150	+920	+810	70 cm	10	14	0,34
SAF201s	655	640	800	425	570	11320	11120	11000	+950	+920	+810	70 cm	15	19	0,33
SAF201p	655	640	800	425	570	11500	11300	11180	+950	+920	+810	70 cm	15	19	0,33
SAF210	655	640	780	430	575	12170	11860	11650	+950	+920	+810	70 cm	10	14	0,34
SAF211s	655	640	800	425	570	13280	12970	12760	+900	+920	+810	70 cm	15	19	0,33
SAF211p	655	640	800	425	570	13460	13150	12940	+900	+920	+810	70 cm	15	19	0,33

### Extra Tyg Läder, Fabric Leather

Klädd sits Upholstered seat

Artno SAF100, SAF101, SAF200, SAF201

SEK/styck pcs	1 styck pc	2-10 styck pcs	11- styck pcs
Prisgrupp Pricegroup 1	+1460	+730	+410
Prisgrupp Pricegroup 2	+1570	+780	+460
Prisgrupp Pricegroup 3	+1730	+870	+520
Prisgrupp Pricegroup 4	+2050	+1030	+640
Standard läder leather	+910	+910	+910

### Extra Tyg Läder, Fabric Leather

Klädd sits och rygg Upholstered seat and back

Artno SAF110, SAF111, SAF210, SAF211

SEK/styck pcs	1 styck pc	2-10 styck pcs	11- styck pcs
Prisgrupp Pricegroup 1	+1460	+920	+720
Prisgrupp Pricegroup 2	+1570	+1000	+800
Prisgrupp Pricegroup 3	+1730	+1110	+900
Prisgrupp Pricegroup 4	+2050	+1340	+1120
Standard läder leather	+1790	+1790	+1790

## Soff-/Bänk system.

Meander består av rak soffa och bänk i tre olika längder, samt kurvade delar i 45 och 90 graders vinkel. Soffans rygg är böjd antingen som en inner- eller ytterdel. Alla gavlur är förberedda för förankring i golv. Soffa och bänk kan kopplas samman, förses med armstöd och eluttag. Träslagen är ek, ask, standardbetsler på ask och vitpigmenterad ek eller ask. Meander levereras monterad. Om skada uppstår på sits eller rygg går det enkelt att skruva loss med handverktyg och byta ut eller slipa om.

## Sofa/Bench system.

Meander comprises a straight sofa and bench in three different lengths, complemented by curved modules with 45° and 90° angles. The sofa's backrest follows the curved inner or outer lines of the sofa. All end sections are prepared so that they can be anchored to the floor. Sofa and bench sections can be linked and fitted with armrests or electric outlets. Choose from oak, ash, standard stains on ash, or white glaze on oak or ash. Meander is supplied assembled. Any damage sustained to seat or backrest can simply be repaired by unscrewing the element in question with a hand tool and replacing it or sanding down the affected area.

### Artno SOFFA RAK SOFA STRAIGHT

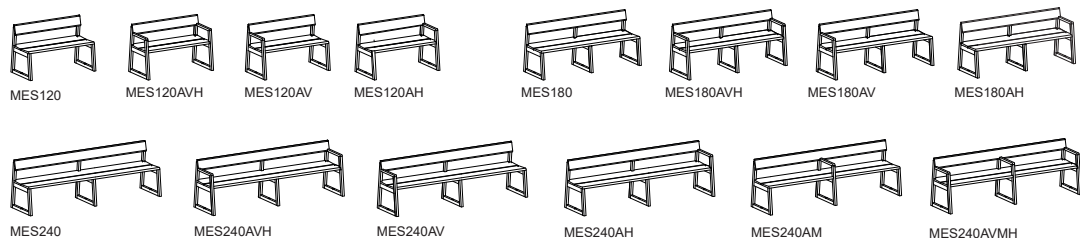

### SOFFA SOFA INNER 45°



### SOFFA YTTRE SOFA OUTER 45°



### SOFFA SOFA INNER 90°

endast för koppling eller fästas i golv  
only for connecting or secured into floor



### SOFFA YTTRE SOFA OUTER 90°

endast för koppling eller fästas i golv  
only for connecting or secured into floor



### Artno BÄNK RAK BENCH STRAIGHT

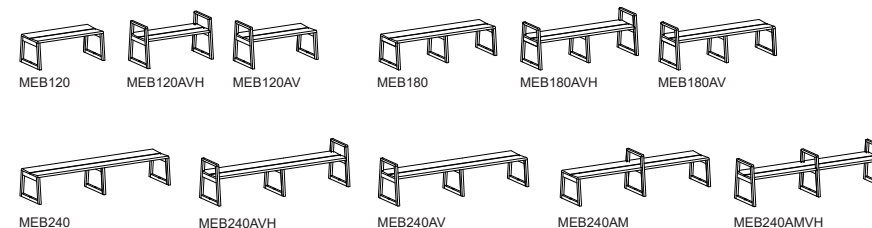

### BÄNK BENCH 45°

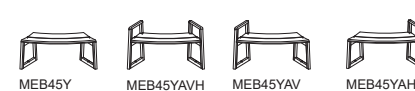

### BÄNK BENCH 90°

endast för koppling eller fästas i golv  
only for connecting or secured into floor

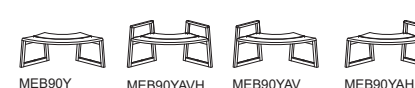

### FÖRSLAG SUGGESTIONS

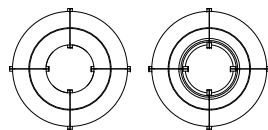

4 x MEB90Y  
diam 1920/650



1xMES45YAV, 2xMES45I, 1xMES45Y, 1xMES45YAH  
L5175 W740

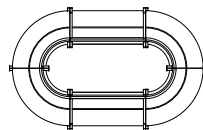

2xMES120AVH, 4xMES90Y  
L3120 W1920 innermått inner L1850 W650



1xMES90YAV, 2xMES90I, 1xMES90Y, 1xMES90YAH  
L5005 W920

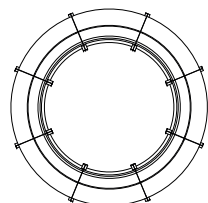

8 x MES45Y  
diam 3220/1940

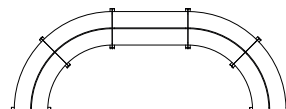

1xMEB120, 4xMEB45Y  
L3940 W1830

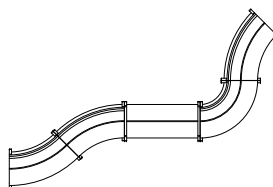

1xMES45Y, 2xMES45I, 1xMEB120AVH, 1xMES90Y  
L4280 W2850

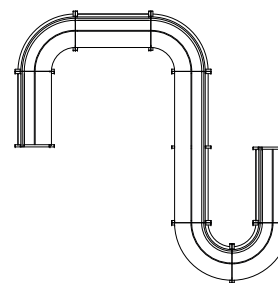

1xMES120AV 2xMES90I, 1xMES120,  
1xMES240, 2xMES90Y, 1xMES120AH  
L4420 W4330

Artno	Längd Length mm	Djup Depth mm	Höjd Height mm	Sithöjd Seat height mm	Meander SEK		Vikt netto Weight net kilos	Vikt brutto Weight gross kilos	Volym Volume
					.10 ek oak .30 ask ash	Standardbets på ask Standard stain on ash Vitpigment ek ask White glazed oak ash			
<b>SOFFA RAK SOFA STRAIGHT</b>									
MES120	1200	625	800	470	12320	+1840	20	50	0,42
MES120AVH	1200	625	800	470	13100	+1970	22	52	0,42
MES120AV	1200	625	800	470	12710	+1900	21	51	0,42
MES120AH	1200	625	800	470	12710	+1900	21	51	0,42
MES180	1800	625	800	470	18290	+2750	32	70	0,67
MES180AVH	1800	625	800	470	19070	+2850	34	72	0,67
MES180AV	1800	625	800	470	18680	+2810	33	71	0,67
MES180AH	1800	625	800	470	18680	+2810	33	71	0,67
MES240	2400	625	800	470	21260	+3190	38	80	0,82
MES240AVH	2400	625	800	470	22050	+3320	40	82	0,82
MES240AV	2400	625	800	470	21660	+3340	39	81	0,82
MES240AH	2400	625	800	470	21660	+3340	39	81	0,82
MES240AM	2400	625	800	470	21660	+3340	39	81	0,82
MES240AVMH	2400	625	800	470	22450	+3360	41	82	0,82
<b>SOFFA SOFA 45 °</b>									
MES45I	1225/750	625	800	470	17210	+2590	19	50	0,42
MES45IAV	1220/750	625	800	470	17620	+2640	20	51	0,42
MES45IAH	1220/750	625	800	470	17620	+2640	20	51	0,42
MES45Y	1225/750	625	800	470	16580	+2480	19	50	0,42
MES45YAVH	1225/750	625	800	470	17370	+2610	22	52	0,42
MES45YAV	1225/750	625	800	470	16970	+2550	20	51	0,42
MES45YAH	1225/750	625	800	470	16970	+2550	20	51	0,42
<b>SOFFA SOFA 90 °</b>									
MES90I	1350/475	625	800	470	18390	+2760	20	51	0,53
MES90IAV	1350/475	625	800	470	18780	+2820	21	52	0,53
MES90IAH	1350/475	625	800	470	18780	+2820	21	52	0,53
MES90Y	1350/475	625	800	470	17010	+2550	19	50	0,53
MES90YAVH	1350/475	625	800	470	17800	+2670	21	52	0,53
MES90YAV	1350/475	625	800	470	17410	+2610	20	51	0,53
MES90YAH	1350/475	625	800	470	17410	+2610	20	51	0,53

Artno	Längd Length mm	Djup Depth mm	Höjd Height mm	Sithöjd Seat height mm	Meander SEK		Vikt netto Weight net kilos	Vikt brutto Weight gross kilos	Volym Volume
					.10 ek oak .30 ask ash	Standardbets på ask Standard stain on ash Vitpigment ek ask White glazed oak ash			
<b>BÄNK RAK BENCH STRAIGHT</b>									
MEB120	1200	625		470	9870	+1480	16	45	0,42
MEB120AVH	1200	625	670	470	10850	+1630	18	47	0,42
MEB120AV	1200	625	670	470	10360	+1560	17	46	0,42
MEB180	1800	625		470	14760	+2220	25	60	0,67
MEB180AVH	1800	625	670	470	15740	+2360	27	62	0,67
MEB180AV	1800	625	670	470	15240	+2290	26	61	0,67
MEB240	2400	625		470	17030	+2570	29	70	0,82
MEB204AVH	2400	625	670	470	18020	+2690	31	72	0,82
MEB240AV	2400	625	670	470	17530	+2630	30	71	0,82
MEB240AM	2400	625	670	470	17530	+2630	30	71	0,82
MEB240AVMH	2400	625	670	470	18520	+2790	32	73	0,82
<b>BÄNK BENCH 45 °</b>									
MEB45Y	1225/750	625		470	13180	+1980	18	50	0,42
MEB45YAVH	1225/750	625	670	470	14170	+2120	18	52	0,42
MEB45YAV	1225/750	625	670	470	13670	+2060	19	51	0,42
MEB45YAH	1225/750	625	670	470	13670	+2060	19	51	0,42
<b>BÄNK BENCH 90 °</b>									
MEB90Y	1350/475	625		470	13820	+2080	18	50	0,53
MEB90YAVH	1350/475	625	670	470	14810	+2230	20	52	0,53
MEB90YAV	1350/475	625	670	470	14310	+2140	19	51	0,53
MEB90YAH	1350/475	625	670	470	14310	+2140	19	51	0,53

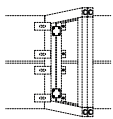
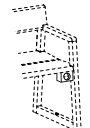
Tillbehör Accessories Sofa Sofa Bänk Bench	Artno	SEK
	MEKB	<b>Kopplingsbeslag i metall placerad under sits.</b> Link fittings metal placed under the seat. 200
	MEEL	<b>1 eluttag inkl. 2 meter kabel. Placeras nära ben i framkant under sits. Gäller för SE, NO, DK, FIN, DE, NL.</b> 1 electrical outlets incl. 2 meters cable. Placed close to legs in front under the seat. For SE, NO, DK, FIN, DE, NL. 1740

Sofforna 3-sits och 2-sits finns med både hög och låg rygg. Soffan 1,5-sits finns endast med hög rygg medan fåtöljen finns endast med låg rygg. Gemensamt för alla modeller är att de finns i två sitthöjder; 430 och 480 mm. Rygg och gavel kommer i beige, antracit eller ljus-grå filt, alternativt kan kläs med likadant tyg som sitt- och ryggdyna (läder går dock ej att klä ryggen i). Samtliga dynor består av kallskum och kan kläs i tyg eller läder. Tjocka tyger bör undvikas. Fråga gärna innan eget tygval.

Benen är försedda med filtassar. Träslagen är massiv ek, ask, standardbetser på ask och vitpigmenterad ek eller ask. Som tillval finns sidokuddar. Pop-up bord, till 3- och 2-sits, i massivträ med lika utförande som soffa. Man kan eftermontera pop-up bord. Eluttag kan monteras i sargen framtill. Ondulé levereras monterad. Med hjälp av handverktyg är det enkelt att separera överliggaren av stommen, benen och sarg, rundstavar, rygg och klädselmaterial. Ange vid beställning: Artikelnummer, färg på gavel/rygg, klädsel på sittplymår, utförande samt ev. tillbehör.

The 2-seat and 3-seat sofas come in both high-back and low-back versions. The 1.5-seat sofa is available with a high back only, while the armchair has a low back. All models offer a choice of two seating heights: 430 mm and 480 mm. The textile backs are in beige, light-grey or anthracite felt, although they may also be ordered in the same fabric as the seat and back cushions. (Please note, however, that it is not possible to choose back covers in leather.) All cushions are of cold-cured foam and can be covered in textile or leather. Thick fabrics are not recommended. Please ask before deciding on your own choice of cover.

Legs are available in a choice of solid oak or ash, standard stains on ash, or white glaze on oak or ash, all with felt floor protectors. Optional extras are side cushions and a pop-up table, for 3- and 2-seat, in solid wood to match your chosen finish on the sofa. Pop-up tables can be added at a later stage. Electrical outlets can be fitted to the front of the rail. Ondulé is supplied assembled. The appropriate hand tools are all that is required to simply disassemble the top rail of the frame, the legs, apron rail, rods, back and covers. Note when ordering: Article number, color of gable/back, fabric, finish and any accessories.

Artno

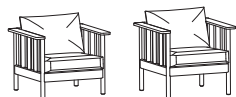

ON1004

ON1007

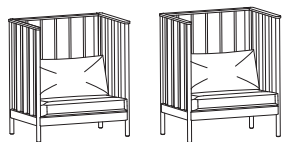

ON1554

ON1557

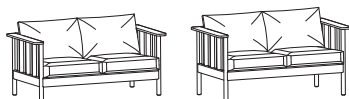

ON2004

ON2007

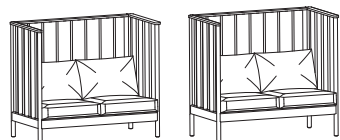

ON2054

ON2057





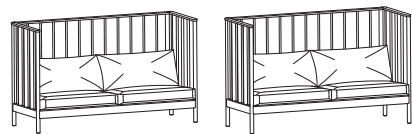

ON3004

ON3007

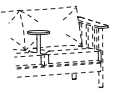

ON3054

ON3057

Tillbehör Accessories	Artno	Mått Dimension mm	SEK	
	se sid 95 see page 95		<b>Gavel och rygg klädd i tyg (ej i läder).</b> Side and back upholstered in fabric (not in leather).	sid page 97
	ONSK	L620 H280	<b>Sidokudde. 2st.</b> Side cushions. 2pcs.	sid page 97
	ONPUB .10 ek oak .30 ask ash  stain on ash or white glazed on oak ash	ø260	<b>Pop-up bord. Massiv trä, klarlack. Placerad mellan sittdynor.</b> <b>Endast till ON2004, 2007, 2054, 2057, 3004, 3007, 3054, 3057</b> Pop-up table. Solid wood, clear lacquer. Placed between seats. Only for models ON2004, 2007, 2054, 2057, 3004, 3007, 3054, 3057	2070  +320 stain or glazed
	TKB11	ø57	<b>Powerdot Mini. 1 eluttag, svart, 1,5m kabel. Monteras i sargen framtill nära ben. Gäller för SE,NO,DK,FIN,DE,NL.</b> Powerdot Mini. 1 electrical black, 1,5m cable. Electrical outlets can be fitted to the front of the rail close to leg. For SE,NO,DK,FIN,DE,NL.	740
	TKB12	ø57	<b>Powerdot Mini. USB A laddare inkl. 2 portar, svart. 1,5m kabel. Monteras i sargen framtill nära ben. Gäller för SE,NO,DK,FIN,DE,NL.</b> Powerdot Mini. USB A charging incl. 2 ports, black. 1,5m cable. Electrical outlets can be fitted to the front of the rail, close to leg. For SE,NO,DK,FIN,DE,NL.	1180
	TKB13	ø35	<b>Powerdot Micro. 1xUSB A laddare, 1xUSB C laddare, svart. 1,5m kabel. Monteras i sargen framtill nära ben. Gäller för SE,NO,DK,FIN,DE,NL.</b> Powerdot Micro. 1xUSB A charging, 1xUSB C charging, black. 1,5m cable. Electrical outlets can be fitted to the front of the rail, close to leg. For SE,NO,DK,FIN,DE,NL.	1180



Artno	Rygg, gavel filt Back, side felt -1 light gray -2 anthracite -3 beige	Längd Length mm	Djup Depth mm	Höjd Height mm	Sithöjd Seat height mm	ONDULÉ SEK	Extra SEK					Tygätgång på 140 cm bredd till sitt- och ryggplymā Requirement of fabric width 140 cm for seat and back cushion	Vikt netto Weight net kilos	Vikt brutto Weight gross kilos	Volym Volume	
						.10 ek oak .30 ask ash	Standardbets på ask Standard stain on ash  Vitpigment ek ask White glazed oak ash	Tyg Fabric Prisgrupp Pricegroup 1	Tyg Fabric Prisgrupp Pricegroup 2	Tyg Fabric Prisgrupp Pricegroup 3	Tyg Fabric Prisgrupp Pricegroup 4					Standard läder Leather
ON1004	-1 light gray -2 anthracite -3 beige	865	810	790	420	22020	+2200	+2040	+2200	+2460	+2970	+4990	160 cm	28	33	1,08
ON1007	-1 light gray -2 anthracite -3 beige	865	810	860	490	22020	+2200	+2040	+2200	+2460	+2970	+4990	160 cm	30	35	1,13
ON1554	-1 light gray -2 anthracite -3 beige	1080	810	1200	420	26130	+2620	+2890	+3160	+3550	+4350	+6550	250 cm	42	50	1,48
ON1557	-1 light gray -2 anthracite -3 beige	1080	810	1270	490	26130	+2620	+2890	+3160	+3550	+4350	+6550	250 cm	44	56	1,53
ON2004	-1 light gray -2 anthracite -3 beige	1530	810	790	420	33230	+3330	+3560	+3900	+4410	+5430	+10000	320 cm	44	50	1,44
ON2007	-1 light gray -2 anthracite -3 beige	1530	810	860	490	33230	+3330	+3560	+3900	+4410	+5430	+10000	320 cm	46	55	1,51
ON2054	-1 light gray -2 anthracite -3 beige	1415	810	1200	420	38590	+3870	+3560	+3900	+4410	+5430	+10000	320 cm	54	60	2,1
ON2057	-1 light gray -2 anthracite -3 beige	1415	810	1270	490	38590	+3870	+3560	+3900	+4410	+5430	+10000	320 cm	58	64	2,16
ON3004	-1 light gray -2 anthracite -3 beige	2190	810	790	420	40080	+4010	+5280	+5810	+6600	+8190	+13100	500 cm	65	75	2,07
ON3007	-1 light gray -2 anthracite -3 beige	2190	810	860	490	40080	+4010	+5280	+5810	+6600	+8190	+13100	500 cm	70	80	2,17
ON3054	-1 light gray -2 anthracite -3 beige	2080	810	1200	420	46640	+4660	+5280	+5810	+6600	+8190	+13100	500 cm	75	85	2,8
ON3057	-1 light gray -2 anthracite -3 beige	2080	810	1270	490	46640	+4660	+5280	+5810	+6600	+8190	+13100	500 cm	80	90	2,9

Artno	ONDULÉ SEK	Tyg Fabric Prisgrupp Pricegroup 1	Tyg Fabric Prisgrupp Pricegroup 2	Tyg Fabric Prisgrupp Pricegroup 3	Tyg Fabric Prisgrupp Pricegroup 4	Standard läder Leather	Tygätgång 140cm bredd till gavel och rygg Requirement of fabric width 140 cm for gavel and back	Tygätgång 140cm bredd till sidokudde Requirement of fabric width 140 cm for side pillow
<b>Tillbehör Accessories</b>								
Klädsel gavel och bakrygg till Upholstery side and back for								
ON1004-9, ON1007-9	1080	+2420	+2630	+2950	+3580	--	200 cm	
ON1554-9, ON1557-9	1180	+6610	+7290	+8310	+10350	--	640 cm	
ON2004-9, ON2007-9	1380	+2420	+2630	+2950	+3580	--	200 cm	
ON2054-9, ON2057-9	1380	+7280	+8030	+9160	+11420	--	710 cm	
ON3004-9, ON3007-9	1640	+2700	+2950	+3310	+4040	--	230 cm	
ON3054-9, ON3057-9	1640	+8620	+9520	+10870	+13570	--	850 cm	
ONSK 2pcs Sidokudde Side cushions	3350	+1170	+1250	+1360	+1580	+2100		70 cm

**Soffa.**  
 Stoppning kallsaum. Klädd rygg med klädda knappar och klädd sits, exkl tyg/läder.  
 Stoppning kallsaum.  
 Ben i massiv trä. Ytbehandling klarlack. Sofan levereras monterad.  
 Vid beställning ange artikelnummer, utförande och klädsel.

**Sofa.**  
 Padding polyether. Upholstered back incl. bottom and and upholstered seat excl. fabric/leather.  
 Legs in solid wood. Finish clear lacquer. The sofa comes pre-assembled.  
 When ordering article number, execution and name of fabric/leather.

Artno

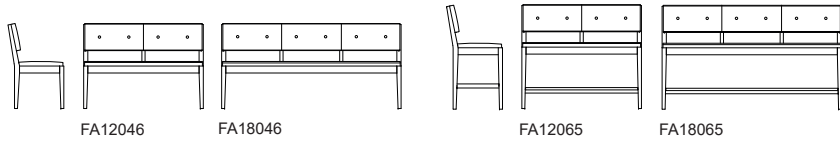

Soffa Sofa FA12065 Pop-up bord table FAPUB | Hylla Shelf CUBE BRICK | Pall Stool SHELL | Bord Table LOLLIPOP

Tillbehör Accessories	Artno	Mått Dimension mm	
	FAASV	B/W 41	<b>Armstöd. Vänsterställd. Massiv trä, klarlack.</b> Armrest. Left hung. Solid wood.
	FAASH	B/W 41	<b>Armstöd. Högerställd. Massiv trä, klarlack.</b> Armrest. Right hung. Solid wood, clear lacquer
	FAPUB	ø290	<b>Pop-up bord inkl. 1st krok. Massiv trä, klarlack. Placerad enligt önskemål. Beslag blankkrom.</b> Pop-up table incl. 1pc hook. Solid wood, clear lacquer. Placed upon request. Fitting polished chrome
	FAKB1	L275 B/W450	<b>Kopplingsbord, rak. Fanerad trälamell, klarlack.</b> Linking table, straight. Veneered blockboard, clear lacquer.
	FAKB2	450x450	<b>Kopplingsbord hörn. Fanerad trälamell, klarlack.</b> Linking table, corner. Veneered blockboard, clear lacquer.
	FAKB2S	450x450 skål bowl ø250	<b>Kopplingsbord hörn. Fanerad trälamell, klarlack. Inkl. planteringskärn svart ABS plast.</b> Linking table, corner. Veneered blockboard, clear lacquer. Incl. planting bowl black ABS plastic.
	FAKBS		<b>Kopplingsbeslag mellan soffor. Svart metall.</b> Link fittings between sofas. Black metal.

Artno	Längd Length mm	Djup Depth mm	Höjd Height mm	Sithöjd Seat height mm	Facile SEK	Extra SEK					Tygåtgång på 140 cm bredd Requirement of fabric width 140 cm	Vikt netto Weight net kilos	Vikt brutto Weight gross kilos	Volym Volume	
					.10 ek oak .30 ask ash	Standardbets på ask Standard stain on ash  Vitpigment ek ask White glazed oak ash	Tyg Fabric Prisgrupp Pricegroup 1	Tyg Fabric Prisgrupp Pricegroup 2	Tyg Fabric Prisgrupp Pricegroup 3	Tyg Fabric Prisgrupp Pricegroup 4					Standard läder Leather
FA12046	1200	560	852	460	18530	+2790	+1840	+1990	+2220	+2750	+5140	140 cm	22	60	1,06
FA18046	1800	560	852	460	22400	+3360	+2420	+2630	+2950	+3580	+7040	200 cm	31	80	1,68
FA12065	1200	560	1042	650	20750	+3110	+1840	+1990	+2220	+2750	+5140	140 cm	28	70	1,26
FA18065	1800	560	1042	650	24970	+3740	+2420	+2630	+2950	+3580	+7040	200 cm	36	90	2,0

Artno	Längd Length mm	Bredd Width mm	Diam mm	Tillbehör Accessories SEK	Extra SEK	
				.10 ek oak .30 ask ash	Standardbets på ask Standard stain on ash  Vitpigment ek ask White glazed oak ash	Vikt brutto Weight gross kilos
FAASV Armstöd vänster Armrest left		41		950	+150	0,5
FAASH Armstöd höger Armrest right		41		950	+150	0,5
FAPUB Pop-up bord table			290	2350	+360	2
FAKB1 Koppl.bord rak Linking table straight	275	450		1950	+300	3
FAKB2 Koppl.bord hörn Linking table corner	450	450		3070	+460	8
FAKB2S Koppl.bord hörn inkl. planteringskäril Linking table corner incl. planting bowl	450	450	250 skål bowl	3710	+460	9
FAKBS Koppl.beslag, svart Link fittings, black				370 svart black metal		

# KAMÓN BENCH

Moni Beuchel 2001



## Bänk.

Synliga trädetaljer på sits, ben i massiv trä. Ytbehandling klarlack.  
Stoppning i kallsaum. Klädd exkl. tyg/läder.  
Bänken levereras monterad. Vid beställning ange artikelnummer, utförande och klädsel.

## Bench.

Visible wood parts under seat. Legs in solid wood. Finish clear lacquer.  
Upholstered excl. fabric/leather. Padding in cold-cured foam.  
The bench comes pre-assembled. When ordering article number, execution and name of fabric/leather.

Artno

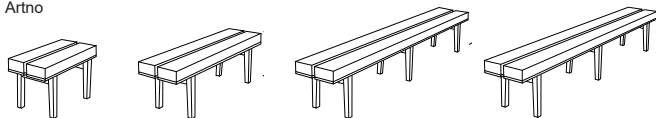

371

372

373

374

Artno	Längd Length mm	Bredd Width mm	Höjd Height mm	Kamón Bänk Bench SEK		Extra SEK								Tygätgång på 140 cm bredd Requirement of fabric width 140 cm	Vikt brutto Weight gross kilos	Volym Volume
				.10 ek oak .20 björk birch .30 ask ash	.50 Lack Color	Standardbets på ask Standard stain on ash  Vitpigment ek ask White glazed oak ash	Tyg Fabric Prisgrupp Pricegroup 1	Tyg Fabric Prisgrupp Pricegroup 2	Tyg Fabric Prisgrupp Pricegroup 3	Tyg Fabric Prisgrupp Pricegroup 4	Standard läder Leather					
371	650	370	440	8750	9210	+1330	+1460	+1570	+1730	+2050	+1710	90 cm	7	0,12		
372	1300	370	440	11720	12610	+1750	+1940	+2100	+2330	+2810	+3290	150 cm	11	0,25		
373	1950	370	440	16750	18000	+2500	+2610	+2840	+3190	+3890	+4820	220 cm	15	0,38		
374	2600	370	440	18680	20000	+2810	+3180	+3480	+3920	+4810	+6430	280 cm	19	0,5		

# KAMÓN LOUNGE

Moni Beuchel 2001



## Soffa.

Synliga trädetaljer på sits och rygg, ben i massiv trä. Ytbehandling klarlack.  
Stoppning i kallsaum. Klädd exkl. tyg/läder.  
Soffan levereras monterad. Vid beställning ange artikelnummer, utförande och klädsel.

## Sofa.

Visible wood parts under seat and back. Legs in solid wood. Finish clear lacquer.  
Upholstered excl. fabric/leather. Padding in cold-cured foam.  
The sofa comes pre-assembled. When ordering article number, execution and name of fabric/leather.

Artno

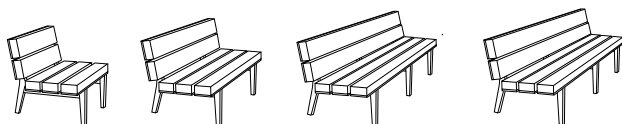

361

362

363

364

Artno	Längd Length mm	Djup Depth mm	Höjd Height mm	Sithöjd Seat height mm	Kamón Lounge SEK		Extra SEK								Tygätgång på 140 cm bredd Requirement of fabric width 140 cm	Vikt brutto Weight gross kilos	Volym Volume
					.10 ek oak .20 björk birch .30 ask ash	.50 Lack Color	Standardbets på ask Standard stain on ash  Vitpigment ek ask White glazed oak ash	Tyg Fabric Prisgrupp Pricegroup 1	Tyg Fabric Prisgrupp Pricegroup 2	Tyg Fabric Prisgrupp Pricegroup 3	Tyg Fabric Prisgrupp Pricegroup 4	Standard läder Leather					
361	650	695	750	440	14860	15930	+2230	+2130	+2310	+2580	+3120	+3870	170 cm	21	0,38		
362	1300	695	750	440	21730	23710	+3240	+3370	+3690	+4170	+5120	+6760	300 cm	32	0,75		
363	1950	695	750	440	30680	33370	+4600	+4610	+5070	+5750	+7110	+9890	430 cm	45	1,1		
364	2600	695	750	440	34240	37430	+5110	+5850	+6440	+7340	+9120	+13200	560 cm	54	1,5		

# KAMÓN DINNER

Moni Beuchel 2017



## Soffa.

Klädd rygg och sits exkl. tyg/läder. Stoppling kallsikum.  
Ben i massiv trä. Ytbehandling klarlack. Soffan levereras monterad.  
Vid beställning ange artikelnummer, utförande och klädsel.

## Sofa.

Upholstered back and seat excl. fabric/leather. Padding in cold-cured foam.  
Legs in solid wood. Finish clear lacquer. The sofa comes pre-assembled.  
When ordering article number, execution and name of fabric/leather.

Artno

Rak soffa / Straight sofa



382

383

384

Innerhorn / Inner corner

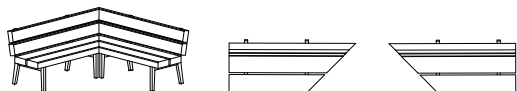

Höger / Right  
382IH  
383IH  
384IH

Vänster / Left  
382IV  
383IV  
384IV

Ytterhorn / Outer corner

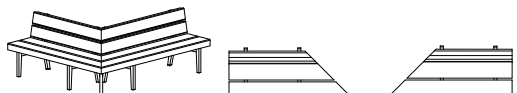

Höger / Right  
382YH  
383YH  
384YH

Vänster / Left  
382YV  
383YV  
384YV



Tillbehör Accessories	Artno	Mått Dimension mm	
	381AS1.3		<b>Armstöd klädd. Placerad enligt önskemål, ej över ben. Beslag svart metall.</b> Armrest upholstered. Placed upon request, not over leg. Fitting black metal.
	381AS2.3		<b>Armstöd klädd. Placerad över ben. Beslag svart metall.</b> Armrest upholstered. Placed over leg. Fitting black metal.
	381PB1	L494 ø280 H655 från golv from floor	<b>Pop-up bord. Massiv trä, klarlack. Placerad enligt önskemål, ej över ben. Beslag svart metall.</b> Pop-up table. Solid wood, clear lacquer. Placed upon request, not over leg. Fitting black metal.
	381PB2	L494 ø280 H655 från golv from floor	<b>Pop-up bord. Massiv trä, klarlack. Placerad över ben. Beslag svart metall.</b> Pop-up table. Solid wood, clear lacquer. Placed over leg. Fitting black metal.
	381KB1	450x450	<b>Kopplingsbord rak.</b> Linking table, straight.
	381KB2	450x450	<b>Kopplingsbord hörn.</b> Linking table, corner.
	381.EL.1		<b>1 eluttag inkl. 2meter kabel. Placeras nära benen i framkant under sits.</b> 1 electrical outlets incl. 2meters cable. Placed close to legs in front under seat.
	381.KB		<b>Kopplingsbeslag. Svart metall.</b> Link fittings. Black metal.

Artno	Längd Length mm	Djup Depth mm	Höjd Height mm	Sitt höjd Seat height mm	Kamón Dinner SEK		Extra SEK								Tygätgång på 140 cm bredd Requirement of fabric width 140 cm	Vikt brutto Weight gross kilos	Volym Volume
					.10 ek oak .20 björk birch .30 ask ash	.50 Lack Color	Standardbets på ask Standard stain on ash Vitpigment ek ask White glazed oak ash	Tyg Fabric Prisgrupp Pricegroup 1	Tyg Fabric Prisgrupp Pricegroup 2	Tyg Fabric Prisgrupp Pricegroup 3	Tyg Fabric Prisgrupp Pricegroup 4	Standard läder Leather					
<b>Soffa rak Sofa straight</b>																	
382	1300	656	818	460	16420	18860	+2460	+3560	+3900	+4410	+5430	+6860	320 cm	32	0,8		
383	1950	656	818	460	21900	25160	+3300	+4850	+5280	+5990	+7420	+10020	450 cm	47	1,2		
384	2600	656	818	460	26460	30420	+3950	+6040	+6660	+7580	+9420	+13360	580 cm	56	1,6		
<b>Hörn Corner</b>																	
382IH	1300	656	818	460	21180	23630	+2460	+3560	+3900	+4410	+5430	+6860	320 cm	32	0,8		
382IV	1300	656	818	460	21180	23630	+2460	+3560	+3900	+4410	+5430	+6860	320 cm	32	0,8		
382YH	1300	656	818	460	21600	24050	+2460	+3560	+3900	+4410	+5430	+6860	320 cm	32	0,8		
382YV	1300	656	818	460	21600	24050	+2460	+3560	+3900	+4410	+5430	+6860	320 cm	32	0,8		
383IH	1950	656	818	460	26670	29950	+3300	+4850	+5280	+5990	+7420	+10020	450 cm	47	1,2		
383IV	1950	656	818	460	26670	29950	+3300	+4850	+5280	+5990	+7420	+10020	450 cm	47	1,2		
383YH	1950	656	818	460	27090	30370	+3300	+4850	+5280	+5990	+7420	+10020	450 cm	47	1,2		
383YV	1950	656	818	460	27090	30370	+3300	+4850	+5280	+5990	+7420	+10020	450 cm	47	1,2		
384IH	2600	656	818	460	31250	35200	+3950	+6040	+6660	+7580	+9420	+13360	580 cm	56	1,6		
384IV	2600	656	818	460	31250	35200	+3950	+6040	+6660	+7580	+9420	+13360	580 cm	56	1,6		
384YH	2600	656	818	460	31660	35620	+3950	+6040	+6660	+7580	+9420	+13360	580 cm	56	1,6		
384YV	2600	656	818	460	31660	35620	+3950	+6040	+6660	+7580	+9420	+13360	580 cm	56	1,6		

Artno	Längd Length mm	Bredd Width mm	Diam mm	Höjd Height mm	Tillbehör Accessories SEK			Extra SEK								Tygätgång på 140 cm bredd Requirement of fabric width 140 cm	Vikt brutto Weight gross kilos
					Klädd exkl tyg/läder Upholstred excl fabric/leather	.10 ek oak .20 björk birch .30 ask ash	.50 Lack Color	Standardbets på ask Standard stain on ash Vitpigment ek ask White glazed oak ash	Tyg Fabric Prisgrupp Pricegroup 1	Tyg Fabric Prisgrupp Pricegroup 2	Tyg Fabric Prisgrupp Pricegroup 3	Tyg Fabric Prisgrupp Pricegroup 4	Standard läder Leather				
381AS1.3 Armstöd Armrest					2570					+990	+1040	+1110	+1270	+1070	45 cm	1	
381AS2.3 Armstöd Armrest					2570					+990	+1040	+1110	+1270	+1070	45 cm	1	
381PB1 Pop-up bord table	494		280	655 från golv from floor		3350	3860	+510								2	
381PB2 Pop-up bord table	494		280	655 från golv from floor		3350	3860	+510								2	
381KB1 Koppl.bord rak Linking table straight	450	450				3050	3510	+450								3	
381KB2 Koppl.bord hörn Linking table corner	450	450				4270	4920	+650								8	
381EL1 Eluttag Electrical outlet						1740	1740	+130								1	
381.KB Koppl.beslag svart Link fittings black							300 svart black									1	

# SENAB

## Färgmarkeringar och/eller symboler för hållbara alternativ i prislistan:

### Mörkgrön markering eller symbol

Miljömärkt produkt – Möbler där hela den sammansatta varan har en typ 1 miljömärkning enligt ISO 14024 med Svanen, Möbelfakta, EU Ecolabel eller annan likvärdig märkning.

### Ljusgrön markering eller symbol

Hållbarhetsmärkt produkt eller beståndsdel – Möbler där hela eller delar av den sammansatta varan är hållbarhetsmärkt, exempelvis med FSC, EU Ecolabel eller OEKO-TEX®. Leverantören ska kunna ge mer detaljerad information om vilka delar eller variationer som är hållbarhetsmärka vid begäran.

### Orange markering eller symbol

Klimatberäknad produkt – Produkt med dokumenterad miljövarudeklaration (EPD) enligt ISO 14025.

### Lila markering eller symbol

Produkt med återvunnet eller förnybart material (enligt definitionerna i ISO 14021). Leverantören ska kunna ge information om andel (%) återvunnet och/eller förnybart (biobaserat) vid begäran. Märkning av återvinningsbart material utgår.

### Blå markering eller symbol

Demonterbar produkt – Produkt som är demonterbar till olika komponenter och beståndsdelar som i första hand möjliggör återbruk och i andra hand materialåtervinning när produkten nått sin fulla livslängd. Produkten ska vara designad för renovering, det vill säga att det ska vara enkelt att reparera och byta ut moduler, komponenter och beståndsdelar som slits över tid. Exempelvis ska ytskikt, som bordsskivor, textil och stoppning kunna tas isär, avlägsnas och ersättas med hjälp av vanligt förekommande manuella verktyg, ej specialverktyg. Enklare reparationer och utbytesarbeten ska kunna utföras av en lekman. Om det krävs fackmanakunskap för mer avancerade arbeten ska det framgå av anvisningarna som leverantören ska kunna ge vid begäran. Anvisningarna ska innehålla en sprängskiss, steg för steg beskrivning inklusive vilka verktyg som krävs samt hur möbelns ingående delar bör källsorteras.

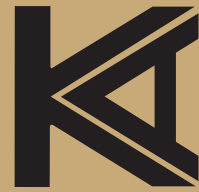

KARL ANDERSSON & SÖNER

**Handmade in Huskvarna. Since 1898.**

**Karl Andersson & Söner** Rosendalagatan 6, SE-561 34 Huskvarna, Sweden.  
+46(0)36-13 25 30. [info@karl-andersson.se](mailto:info@karl-andersson.se)

**Showrooms**

**Studio B3.** Barnhusgatan 3. Stockholm. +46 (0)8 21 42 31  
**Studio L6.** Lasarettsgatan 6. Göteborg. +46 (0)31 13 83 90

[karl-andersson.se](http://karl-andersson.se)