

company  
products  
price list  
2023



# 2023

# contents

# SENAB

## Färgmarkeringar och/eller symboler för hållbara alternativ i prislistan:

### Mörkgrön markering eller symbol

Miljömärkt produkt – Möbler där hela den sammansatta varan har en typ 1 miljömärkning enligt ISO 14024 med Svanen, Möbelfakta, EU Ecolabel eller annan likvärdig märkning.

### Ljusgrön markering eller symbol

Hållbarhetsmärkt produkt eller beståndsdel – Möbler där hela eller delar av den sammansatta varan är hållbarhetsmärkt, exempelvis med FSC, EU Ecolabel eller OEKO-TEX®. Leverantören ska kunna ge mer detaljerad information om vilka delar eller variationer som är hållbarhetsmärka vid begäran.

### Orange markering eller symbol

Klimatberäknad produkt – Produkt med dokumenterad miljövarudeklaration (EPD) enligt ISO 14025.

### Lila markering eller symbol

Produkt med återvunnet eller förnybart material (enligt definitionerna i ISO 14021). Leverantören ska kunna ge information om andel (%) återvunnet och/eller förnybart (biobaserat) vid begäran. Märkning av återvinningsbart material utgår.

### Blå markering eller symbol

Demonterbar produkt – Produkt som är demonterbar till olika komponenter och beståndsdelar som i första hand möjliggör återbruk och i andra hand materialåtervinning när produkten nått sin fulla livslängd. Produkten ska vara designad för renovering, det vill säga att det ska vara enkelt att reparera och byta ut moduler, komponenter och beståndsdelar som slits över tid. Exempelvis ska ytskikt, som bordsskivor, textil och stoppning kunna tas isär, avlägsnas och ersättas med hjälp av vanligt förekommande manuella verktyg, ej specialverktyg. Enklare reparationer och utbytesarbeten ska kunna utföras av en lekman. Om det krävs fackmanakunskap för mer avancerade arbeten ska det framgå av anvisningarna som leverantören ska kunna ge vid begäran. Anvisningarna ska innehålla en sprängskiss, steg för steg beskrivning inklusive vilka verktyg som krävs samt hur möbelns ingående delar bör källsorteras.

---

## **About the company 5**

How a chair is made 8  
How to use the price list 12

1

---

## **Seating furniture and accessories 15**

Wood, colours, surface finishes 16  
Upholstery and upholstery decorations 22  
Customisation 44

2

---

## **Tables, table tops and bases 109**

Tables 110  
P.O.V. collection 132  
Central leg tables, table tops and bases 152

3

---

## **Benches 187**

Diner 188  
Gufy 191  
Assembly instructions 195

4

---

## **Further information 227**

General terms and conditions 228  
Furniture care & maintenance 228  
Index 230

5



**about the company**

# hand-crafted for generations

We dream of beauty before creating each product.

For us wood bending is all about strength.

A product that is both strong and beautiful is timeless. It passes from generation to generation as our craft.

Our ethos is to conduct ourselves in an honest and friendly manner for the benefit of people and nature.

Milan Dostálík  
CEO

---

Our products are made by people using traditional wood bending technology. Since 1861 the art of wood bending and the love of the craft have been passed from one generation to another in Bystřice pod Hostýnem. In more than 160 years, six generations of craftsmen have worked in the factory and they have made their indelible mark in its history. Our current contribution to the historic milestones

are products using split solid wood bent into opposite directions.

If you have chosen TON products, the chances are that you not only appreciate high quality handcraft but you are also a lover of design and timeless beauty. We are glad to see that by making this decision you have joined the group of extraordinary friends of TON.

## Awards

Our love of wood is not rewarded only by the long-term fruitful production and customer satisfaction. Our ongoing effort to continuously create new products to become integral parts of our custom-

ers' interiors is often also appreciated by design experts. This is attested by a number of awards given to our products.



**merano**

armchair



reddot design award  
winner 2011



**albu**

armchair



GERMAN  
DESIGN  
AWARD  
2018



reddot award 2018  
winner



**leaf**

chair



reddot award 2017  
winner furniture design



DESIGN  
AWARD  
2017



**split**

lounge armchair



reddot award 2016  
winner furniture design



**chips**

lounge armchair



GERMAN  
DESIGN  
AWARD  
2019



reddot award 2019  
winner

chair and barstool



DESIGN  
AWARD  
2015

barstool



DESIGN  
AWARD  
2017



# how a chair is made

## Timber drying

**1** We receive squared timber in the warehouse, which is stored and dried to the required moisture level. The drying process is affected by the initial moisture content, thickness of pieces, type of wood or method of use in the production. It may take up to three months before the required moisture content is achieved.



## Steaming

**2** The most frequently used type of wood for bentwood production is beech, which is placed in saturated steam at around 100 °C. Steaming provides the wood with its typical pink shade. The time spent in steam depends on the diameter of the respective wooden rods.



## Bending process

**3** In the manual bending process, benders fasten a wooden rod into a mould and attach a special support flange before gradually bending both ends of the rod around the mould. The wood structure does not suffer any damage through this process, and remains incredibly strong in spite of its changed shape. It may look simple, but it is a science. Learning how to bend wood manually generally takes about a year.

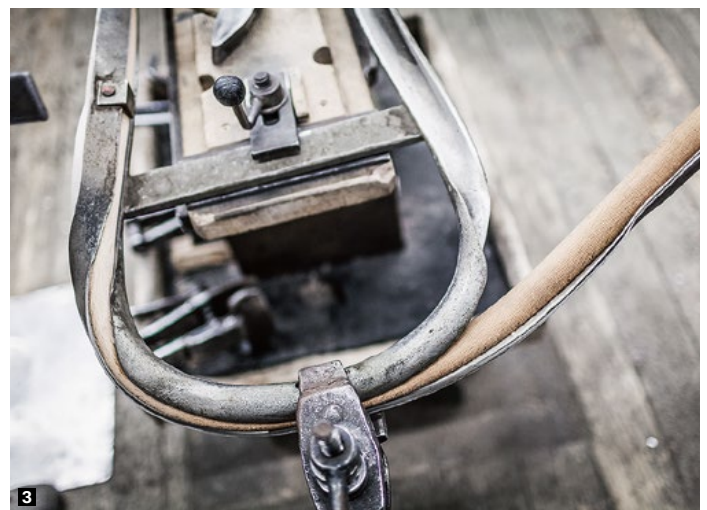

## Staining and lacquering

**4** Individual chair parts and partially assembled chairs travel to the staining area to be submerged in vats of various colour stains. If a customer prefers natural wood colour, the product is finished with lacquer or oil depending on to the type of wood. In addition to a finish with a stain, lacquer or oil, products can also be painted in any RAL colour shade.



## Assembly

**5** Individual parts are assembled manually at a special work station. Each chair has its own assembly procedure. For example, chair no. 14 consists of 6 parts and experienced workers are able to assemble it in 2 minutes.



## Finishing

**6** Lacquering is one of the last steps of the production process. Lacquering is done by skilful hands with each pair possessing a unique feel. Hand finishing gives each product an original feel and creates the magic behind Antique and Gradient finishes. An alternative to lacquer is oil. Applied only to the surface, oil preserves the wood structure better than other finishes. The absorbed oil protects wood fibres and brings out their individual beauty.



## Upholstery

**7** Every upholstered TON product has a pre-determined foam component, making it as comfortable as possible to sit on. Parts from injection moulds are used for more complex shapes. We offer our most demanding customers products with a system of springs in the seat.

## Testing

**8** Quality is our top priority. Our products are rigorously checked throughout the production process. In addition, they are tested under European standard EN 16139 Furniture – Strength, Durability and Safety. A special machine is used to test chairs. It repeatedly subjects them to the prescribed pressure on the seat, backrest or armrests. All chairs can bear a load of  $\pm 115$  kg without any problems. The test results for all of our products are displayed on our website. Woven chairs (with and without a reinforcement mesh) are also tested with a load of 110kg. Tables are tested in certified external testing laboratories under the Czech and European standards ČSN EN 12521 Furniture – Strength, Durability and Safety – Requirements for domestic tables and ČSN EN 15372 Furniture – Strength, Durability and Safety – Requirements for non-domestic tables. Where no official testing method exists, our products are subjected to our own internal tests.

! Considering the continuous development of our products, we reserve the right to make changes in their design, used materials, structure and applied technology in order to improve their utility or appearance.

! The buyer should use the furniture in accordance with Furniture care & maintenance instructions, which can be found on our websites or at the seller's. Responsibility for defects and quality warranty does not cover wear and tear of the product caused by normal use.

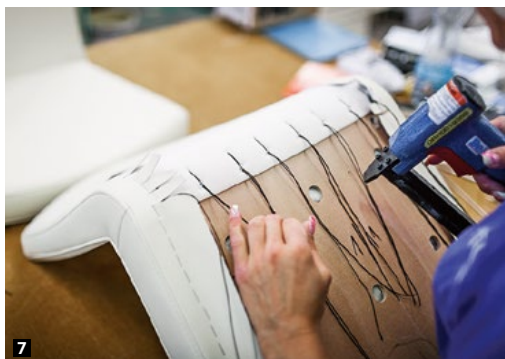
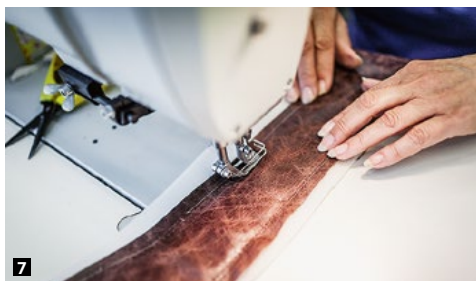

## Warranty

We provide an extended warranty of five years from delivery for all products marketed under the TON trademark, unless the sales contract states otherwise. If the product includes a cane weave, the warranty of two years applies on the cane part only.



## Ecology

TON's entire production process is suffused with respect and consideration for the natural materials, energies and other raw components, and particularly for the human work that goes into it. Our efforts to work in harmony with nature have been crowned by ISO 14001:2015 certification in

environmental management. We make furniture and furniture components from wood certified by the PEFC programme. We comply with the highest ecological, social and ethical standards when we harvest our wood.



ISO 14001:2015



ISO 9001:2015



# how to use the price list

---

## How to use the price list

Information about possible execution of the products and the price section itself are divided into thematic parts. The individual prices, additional charges, dimensions and options are customised for each product number.

We believe that this arrangement will help you specify and choose a product so that it fully corresponds to your ideas and requirements.

---

## Product number

The product number distinguishes individual executions of our products on the basic level and facilitates communication during the processing of orders. In the sales documents, the product number is supplemented with the number of the

variant with coded executions, which the customer chooses according to his/her requirements (the type of wood, colour, upholstery, glides, etc.). For most products, the product number is composed according to the following key:

### ■ Seating furniture

#### Type of furniture

3 seating furniture

#### Subgroup

- 1 chairs
- 2 armchairs
- 3 children's chairs
- 5 revolving and rocking armchairs
- 6 fixed armchairs
- 7 stools and barstools
- 8 benches
- S bench modular system

#### Product execution

- 1 veneered
- 3 upholstered
- 4 additional upholstery – backrest
- 5 cane
- 6 combination (e.g. veneer seat, cane backrest)
- 7 combination (e.g. upholstered seat, cane backrest)

#### Example:

##### Model

Moritz

##### Model number

323 623

3 - seating furniture / 2 - armchair /

3 - upholstered / 623 Moritz

### ■ Tables and table top

#### Type of furniture

- 4 complete table
- 9 table top

#### Table top material

- B multiplex
- D veneered top + veneered edge
- F veneered MDF top
- M solid wood top
- N veneered top + solid wood edge
- U multiplex top + veneered surface
- Y multiplex top + HPL surface
- Z multiplex top + nanolaminate surface

#### Table top thickness

- 1 18 mm
- 5 25 mm
- 6 28 mm
- 8 38 mm
- C 35 mm
- E 33 mm
- G 12 mm
- I 13mm
- J 20 mm

#### Example:

##### Model

Jylland

##### Model number

4M5 476

4 - complete table / M - solid wood top /

5 - thickness 25 mm / 476 Jylland

## Prices and technical specifications

### Product price and surcharges

Listed prices are in € (VAT not included). Prices include products finished in standard colours and any type of glides. Surcharges are added to the given price category according to the product execution. If the price already contains the execution subjected to a surcharge, the surcharge is marked by \* instead. Prices do not include freight costs for deliveries from our premises or TON stores to the customer.

### Dimensions of the products

The given dimensions and weights of the products are standardized. The heights do not include glides. Because of the high proportion of manual processing and the natural character of the material, we reserve the right to dimensional variations to the specified dimension tolerances.

### Packaging

Our products are mostly delivered assembled. This does not apply to tables and certain types of benches, which are delivered in parts for safer handling.

The products are packed in cardboard packaging. Inside, they are usually further protected by packaging material to eliminate damage during transport or storage. The cardboard is purchased in conformity with the international FEFCO standard, with the emphasis on strength parameters (especially pressure on the edge and resistance to side pressure).

### Volume

Number in m<sup>3</sup> represents an approximate average volume taken up by a single piece of product in cargo space of a transport vehicle.

### Consumption of fabric and artificial leather

Consumption is indicated in running meters per 1 product and is calculated for material width 1.4 m for orders in excess of 10 pieces.

### Consumption of leather

Consumption per 1 product is given in square meters.

! If product is returned to TON a.s. for claim etc., it must be packed in the same manner as it was dispatched from the factory. Defects caused during transportation due to insufficient protection may be refused in the claim procedure!

! Upon your request, customised quotation can be made to include product installation and removal of packaging (white glove delivery). This service is offered within Europe.

## Sample books

All colour illustrations of wood, textiles and other materials in all our printed brochures are for orientation purposes only. Even when making selection from physical samples, it is necessary to bear in

mind that natural materials in particular (wood, leather) may absorb finishing materials unevenly. In your orders, please specify the products' execution by using our internal codes.

## Validity of 2023 price list

The 2023 price list, in printed and electronic version, is valid from 28/3/2023 until the new price lists is released. It replaces any previous price lists. The seller reserves the right to change the prices given here at any time, and is under no obligation to inform third parties of any changes.

These prices are therefore not guaranteed and you should always ask the seller for the current prices in advance. It is to be used for orders received at this time, unless otherwise stated in the purchase agreement. TON is not responsible for typographical or print errors.



# **seating furniture and accessories**



# wood, colours, surface finishes

Wood is a fascinating material that is beautiful and pleasing both to the eye and to the touch; it has a characteristic smell, texture and colour, and is synonymous with a safe approach to the environment. Wood is a renewable resource, does not pose any danger to human health and is no burden to the environment – not during its processing, while the products are used, nor after they have reached the end of their life. By planting new trees, their life cycle starts again.

Unlike modern materials, wood can age and acquires a unique maturity and patina over the course of time. By suitable care, wood can be supported in this process. Too low or too high air humidity or temperature adds to the wood's susceptibility to deformation, cracking or discolouring. See our Furniture care & maintenance manual to learn how to take care of the wooden parts of your furniture.

During the manufacturing process, deviations in shape occur, especially when assembling manu-

ally bent parts. To account for this, a dimensional tolerance of  $\pm 2$  cm is specified for the spacing of legs of all bent products.

## ■ PEFC

PEFC (Programme for the Endorsement of Forest Certification) is a non-governmental, non-profit organisation which was founded in 1999 in Geneva. It's an umbrella organisation of several autonomous national certification systems, whose scope protects more than two-thirds of forests worldwide. The PEFC certification system was created to protect forests. Its purpose is to preserve existing forest vegetation, plant new forests, forest management with respect to natural forest eco-systems and mainly to prevent devastation of forests. By labelling a product with the PEFC logo and our certificate number we confirm to our customers that we make products from wood which is acquired legally with support of sustainable forest management.



! Click on this [link](#) for detailed photographs.

## Texture, colouring and other properties of wood

### ■ Wood texture

Texture is the wood's natural pattern and is unique for each type of wood. The texture is determined by colour, lustre, the way the cut is made, and anatomical structure. Deciduous trees have a more complex anatomical structure, due to which we can see with the naked eye annual rings, pores, pith rays, knots, etc. For example, healthy small knots are valued for their decorative appeal. Knots develop in places where new or dead branches are covered by wood. A healthy knot is darker than the surrounding wood and does not diminish the wood quality. Oak differs from other woods by its texture, especially by visible pith rays occurring in a radial (central) cross-section in the form of small, differently coloured spots. These are called "mirrors" and are an evidence of genuine solid oak. In a tangential cut, the texture creates an interesting figured pattern.

Manual bending of wood may create larger or smaller cracks in the wood surface. They are known as superficial splits. They occur mainly when bending wood into large angles and are

caused by the run of the wood fibres. If the direction of the wood grain does not match the bending direction, the wood cracks on the outer side due to high tension inside the material. The bent parts are then carefully checked to ensure that the extent of the split does not compromise their strength or further processing. Superficial cracks can be repaired by gluing to prevent their re-opening. After thorough sanding, the surface becomes smooth and monolithic again. Cracks repaired in this way give the surface a new dimension because they complement the wood pattern with their characteristic shape of the letter 'v'.

### ■ Wood colour

Every tree has its typical colouring determined by climatic conditions and the combination of substances in the cell walls. Change in wood colouring caused by sunshine and oxidation is a natural feature of this material. Wood of lighter trees darkens and greys and by contrast wood of darker trees lightens.

! Wood colouring is also affected by the way it is processed. Before being bent, wooden rods are first steamed for up to several hours. Steaming gives beech wood its typical pinkish colour, the intensity of which differs depending on how long the wood is left in the steam. This phenomenon can be observed when light stains are applied to the wood. The logs are also steamed when making veneer, which changes the wood's properties. The veneer then reacts to stains differently than solid wood. The resulting shade of veneered and solid wood parts then might differ not only due to different production processes, but also due to the effect of UV radiation when the product is used.

! Each beech wood component reacts to selected technology in different ways. This natural property causes variation in component colour finish. Surface finishing with oil highlights these nuances. The colour aspect of independent wood components will even out within a few months in response to light and oxygen effects.

Wood grain



Mirrors



Knots



Cracks



Beech / Oil



## Natural wood finish

The natural wood finish is not modified in any way by staining or other agents during the production process. According to the type of wood, the surface is only finished with transparent lacquer or oil, thus naturally highlighting the wood texture. The execution of products with a natural wood colour is denoted as Natural. There is no surcharge for Natural wood finish.

■ **Beech** / Beech is among the best known and most commonly used deciduous trees. Beech wood is light to pinkish in colour. Beech wood texture is not very distinctive because there is not much difference between the colour of spring and summer wood (so called annual rings). The wood is hard, relatively strong, less elastic, homogeneous and dense.

■ **Oak** / Oak has been one of the most sought-after materials for centuries. Its core is relatively wide, evenly coloured, brownish with grey or yellowish tinges. The wood is strong, hard and very durable. It is the most resilient material against

weather changes and fluctuations of wet and dry periods.

■ **Ash** / Ash is white to yellowish in colour, the white is of a cream tinge; in contrast, the core is dark brown. Its distinct annual rings create a beautiful pattern, which was used in inlays in the past. The wood is strong, hard, resilient and very elastic, therefore it is also suited for making skis, sledges, sporting equipment and bannisters, as well as furniture.

■ **American walnut** / American walnut is native to North America and was brought to Europe in the 17<sup>th</sup> century. It is of dark brown colour with lighter strips and spots of purple tinge. Thanks to its colouring, it is ideal as a substitute in furniture manufacture for more expensive dark wood. American walnut is a hard, strong but relatively light wood from the temperate zone. It is easy to process and its surface shows a beautiful gloss and colouring, especially when treated with oil.

natural  
beech - lacquer/oil

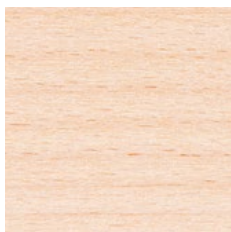

natural  
oak - lacquer/oil



natural  
ash - lacquer

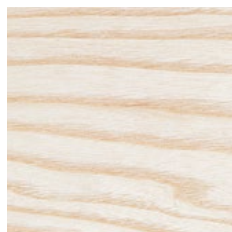

natural  
american walnut - oil

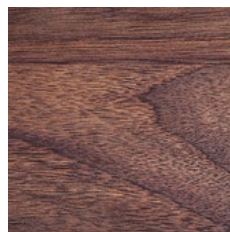

## Surface finish

### ■ Lacquered surface (beech, oak, ash)

The standard finish for our chairs is water-based clear lacquer. UV protection in the lacquer layer slows down natural oxidation changes in the wood colouring. The surface is resilient to the accumulation of dirt and is easy to maintain. According to DIN 4102 Part 1, the transparent lacquer is classified under class B1 in combustibility tests on wooden furniture.

### ■ Oil-treated surface (beech, oak, American walnut)

The clear base of natural oils and waxes creates a matt protective film on the wood surface which does not crack and does not peel, and yet allows the wood to breathe. Minor damages on surfaces treated this way can be easily repaired. Oil layer is applied directly to the machined raw surface which is not treated by any colour before being oiled. The oil brings out the wood's natural colour. This effect can be best observed on American walnut, which we therefore recommend to finish exclusively with oil. With oil, we also finish the products from unstained oak and beech.

! To renovate oiled surfaces, we recommend a special kit, which you will find in the price list under the name Carebox and the identification code CB0004.

! How to proceed with oiling can also be found in the video tutorials on our website.

## Stains

Stains may be used to match beech, oak or ash products to the surroundings. Staining does not affect the wood structure and most colours do not suppress the wood pattern, either. On the contrary, wood as a natural material absorbs colours differently and for this reason the surface is characterised

by lighter or darker places. The colour result is also affected by the initial range of colour of individual woody plants (see illustration photo). Stains are applied by either immersion or spraying. The surface is then finished only with transparent lacquer. There is no surcharge for stain colour finishes.

! The texture in the picture below shows beech. The colour finishes are for illustration purposes only.

**B4 coffee**  
beech/oak/ash - lacquer

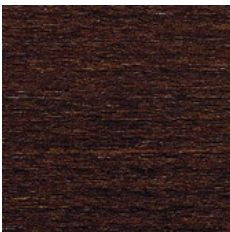

**B105 dark wenge**  
beech/oak/ash - lacquer

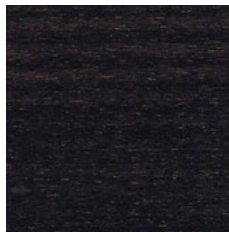

**B112 dark chocolate**  
beech/oak/ash - lacquer

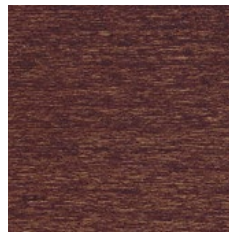

**B114 nougat**  
beech/oak/ash - lacquer



**B115 granite**  
beech/oak/ash - lacquer

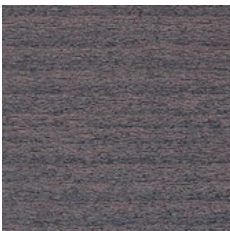

**B116 honey**  
beech/ash - lacquer

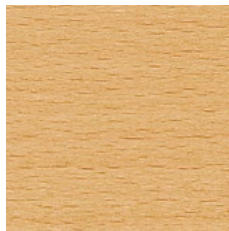

**B123 black grain**  
beech/oak/ash - lacquer

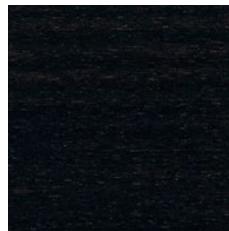

**B276 white powder**  
beech/oak/ash - lacquer

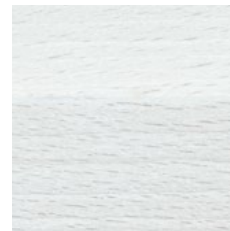

Colour difference between beech and oak in B276 - white powder



## Pigment finishes

The natural colour and texture of wood can be covered with pigment finishes, which create a compact colour layer on the surface. The final appearance of the pigment finishes on the surface is, however, influenced by the type of wood, their different porosity and colour, production technology, light refraction and individual perception of colour finishes (see illustration photo). The relief on beech plywood is so monolithic after being finished with pigment colours that it may look like a pressed plastic part. On the contrary, on the surface of oak or ash, which have more pronounced

pores in their structure, small striations remain visible even after being finished with pigment colours. Pigment finishes are subject to a surcharge as shown in the price list.

Solid wood tables and table tops cannot be finished with pigments from the Pantone, RAL and NCS colour charts. YYY coffee tables are the only exception; these can be finished in pigments. When ordering 1-10 pieces the surcharge is multiplied by three, when ordering 11-30 pieces the surcharge is doubled for the selected model.

! Please note that pigment colours from the Pantone, RAL and NSC colour charts are more susceptible to mechanical damage on the surface!

! Solid wood tables and table tops cannot be finished with pigments from the Pantone, RAL and NCS colour charts. YYY coffee tables are the only exception; these can be finished in pigments.

! Please note that prior to using a pigment chosen by a customer, we first assess whether the selected colour is suitable for our products.

**B20 white**  
RAL 9016  
beech/oak/ash

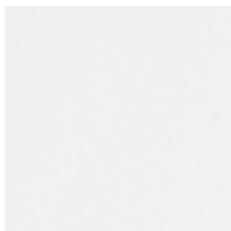

**B31 sandy beige**  
NCS S 3005 - Y20R  
beech/oak/ash



**B32 ginger yellow**  
NCS S 2060 - Y10R  
beech/oak/ash



**B37 ocean blue**  
RAL 5008  
beech/oak/ash

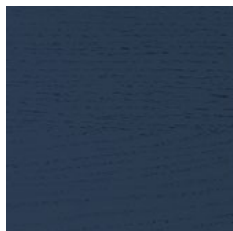

**B38 grey shadow**  
NCS S 7502 - G  
beech/oak/ash



**B40 nude pink**  
NCS S 1010 - Y90R  
beech/oak/ash



**B41 salmon pink**  
NCS S 0570 - Y80R  
beech/oak/ash



**B42 coral orange**  
NCS S 0585 - Y80R  
beech/oak/ash



**B43 ruby red**  
NCS S 1085 - Y90R  
beech/oak/ash



**B44 creamy yellow**  
NCS S 0540 - Y  
beech/oak/ash



**B45 aqua green**  
NCS S 0520 - B70G  
beech/oak/ash



**B46 turquoise green**  
NCS S 2040 - B80G  
beech/oak/ash



**B47 pine green**  
NCS S 8010 - B30G  
beech/oak/ash



**B48 baby blue**  
NCS S 0520 - B  
beech/oak/ash

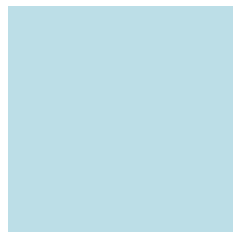

**B49 cloud grey**  
NCS S 2000 - N  
beech/oak/ash

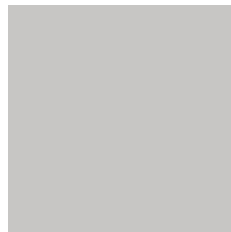

**B50 moon grey**  
NCS S 3500 - N  
beech/oak/ash

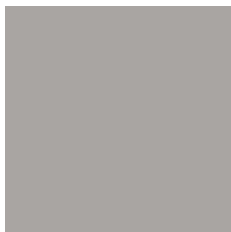

**B52 blue berries**  
NCS S 5030 - R80B  
beech/oak/ash



**B53 opal blue**  
NCS S 3030 - B10G  
beech/oak/ash



**B54 mountain fjord**  
NCS S 5030 - B10G  
beech/oak/ash



**B55 ashy blue**  
NCS S 5020 - R80B  
beech/oak/ash

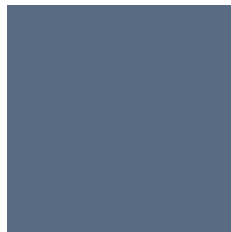

**B61 lichen green**  
NCS S 5020 - B70G  
beech/oak/ash



**B95 taupe pink**  
NCS S 3020 - Y90R  
beech/oak/ash



Colour difference between beech  
and oak in B38 - grey shadow

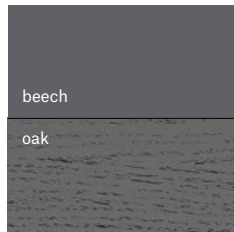

---

## Antique colour

Antique finish is created by using specially developed finishing materials, which are applied manually – this technology underlines the unevenness and the originality of each product. The Antique Classic finish imitates a dark stained chair surface which has been attacked not only by age, but

also by woodworm. Besides irregular, rubbed off, bleached, and hand-worn spots, the surface is also decorated with tiny holes made by the woodworm wood master. Antique colour incurs a surcharge as specified in the price list. The same surcharge applies to Antique cane weave.

! By default, we finish most of the seating furniture in the Antique Classic without faux woodworm holes. In that case, the colour will be identified as B130/A0. Faux holes can only be applied to products in the classic bent collection (identified as TON R&D).

! To be protected against damage by liquids, Antique Classic table top are finished without woodworm holes. In this case, the colour code is B130/A0.

! We apply Antique Classic only to beech wood products.

B130/A antique classic beech



---

## Bicolour

A two-colour combination often emphasises the product's beauty and exceptionality, as it cannot be applied to all products or be used with all colours. For technological reasons, only stain colours can be combined. However, the most popular combination is a base in colour Natural with plywood or table top in a contrasting colour finish. Bicolour is available without a surcharge and is marked by a symbol in the price list.

If you are interested in the bicolour option for a product that does not have a tick mark on the bicolour line in the price list, please contact your sales representative. We try hard to respond favourably to customer requests. Orders that include a non-standard finish incur a surcharge.

! B276, B130/A – white powder, antique classic and pigment colours cannot be combined as bicolour. However, if we receive a specific specification, we will check whether the bicolour you requested for your product is technologically possible. A surcharge applies for this service..



---

## Gradient

From a soft pale to a rich dark colour – this is what the gradient finish looks like. The layers of colour are applied gradually in uneven layers and distances. The colour gradient is further enhanced by manual sanding between the staining layers. In combination with the more prominent texture of

ash wood, this creates a unique combination for each product that cannot be repeated. The surface is finished only with transparent lacquer. We offer the gradient finishes on chairs and armchairs made of ash wood as standard colours without a surcharge.



B501/G gradient turquoise ash – lacquer



B502/G gradient green ash – lacquer



B503/G gradient grey ash – lacquer

## ■ Socks

It is possible to apply special finishing to the ends of legs of selected products from our range, which resembles "socks". We offer colour combinations with socks only in the versions shown below. The

height of the socks is 10 cm (excluding the glide). You can identify the option of application of socks according to the surcharges shown by individual products.



Chair - Natural finish, socks pigment finish



Chair - pigment finish, socks Natural finish



Chair - pigment finish, socks stain finish



Chair - stain finish, socks pigment finish

! Please note that chairs with pigment finishing can only be fitted with natural finish or stained socks.

! Please note that the height of the socks is influenced by the design of the product (e.g. upholstery, leg connection). According to the design, the height of the socks may be increased by up to 5 cm for technological reasons.

! Please note that chairs with natural or stain finishing can only be fitted with socks in a pigment finish.

# upholstery and upholstery decorations

Upholstery materials are divided into price categories. Fabrics and artificial leathers fall under categories A to E and natural leather falls under categories 1 and 2. Natural materials make up more than 50% of many fabrics. All upholstery materials, especially those with high wear resist-

ance, are suitable for use in public areas. Many of them also fulfil the safety requirements for flame retardancy. In compliance with environmental protection, the materials fulfil the requirements of EU regulations or other internationally recognised organisations.

Click on this [link](#) for detailed photographs.

## Fabrics and artificial leathers

### ■ Cotton mixture

Cotton is one of the most important and oldest natural raw materials used to make textiles. Cotton yarn is flexible, soft and pleasant to the touch. Cotton has a high tensile strength and abrasion resistance. In combination with flax yarn, the fabric strength is further increased. Flax yarn is characterised by its single-direction fibre, which gives the fabrics a natural appearance. The admixture of viscose, which is used as a substitute for silk, gives the fabric a higher gloss and more flowing character. The artificial fibres (polyester, acrylic) which are elastic and ductile, increase the flexibility, pliability and shape stability of the mixed fabrics.

### ■ Wool

Wool is a natural fibre of the highest quality. The dyed wool fibres are highly colour-fast. Thanks to the water and protein content, the wool is naturally fire resistant and its ignition point is 700 °C, for which reason it fulfils the high requirements of flammability tests. The wool also has antibacterial properties. The rugged surface of the fibres in combination with their extraordinary ability to absorb moisture prevents growth of bacteria which prefer the smooth walls of artificial fibres. Woollen textiles are good absorbers of noise and increase the sense of peace and quiet around us. Production of wool is based on the principle of renewable energy sources and is environmentally friendly.

### ■ Polyester

Polyester is a synthetic fibre with versatile application in the textile industry thanks to its properties. Polyester fibres have very good resistance to wear and sunlight, which increases their durability and colour-fastness. The cross-section of the fibres influences the properties of the textiles and may lend them a silky appearance and pleasantness to the touch. The polyester materials have low absorption, which makes them easy to maintain.

### ■ Trevira CS

Trevira CS textile polyester fibres are developed especially to fulfil the highest requirements par-

ticularly in the field of fire protection. The letters CS incorporated into the name are a synonym for Comfort & Safety. Fire resistance is incorporated into the actual composition of the fibre. The use of the material, natural ageing or washing do not affect the composition of the fibre, and for this reason Trevira CS textiles do not lose their resistance to fire during usage. This differentiates Trevira CS from textiles that have only a surface protection layer on the fibres. This may be disrupted in time and reduce the resistance of the textile. Properties such as colour-fastness and high abrasion resistance also improve comfort of Trevira CS fabrics. The materials are easy to maintain, wash and dry, which also leads to lower energy consumption and environmental friendliness.

Trevira CS Bioactive fabrics fulfil not only the requirements of preventative fire safety, but also enhanced cleanliness. These fibres contain silver, which has antimicrobial effects. As soon as bacteria come into contact with the surface of the textiles, they are damaged by the silver ions, thus preventing their proliferation. It thus eliminates the creation of odours resulting from the decomposition of bacteria. The antimicrobial effect of the fibre is permanent and does not decline with use, washing or the application of disinfectants. This material pose no hazard to health and does not damage the skin.

### ■ Alcantara

Alcantara is a special textile fabric whose brushed surface has the semblance of velour leather. The essence of the material is fleece made of ultra-thin polyester fibres, which are wrapped with polyurethane. Polyester lends the material strength while polyurethane lends it softness. Alcantara is used for upholstering in the furniture and automotive industry because it is breathable, flexible, crease resistant, wear resistant, plus it is easy to clean, wash and maintain. The unusually dense structure of the material means that it is practically impermeable, so any spilled fluids do not cause stains. They remain on the surface, from where they can be removed easily.

Virgin wool comes directly from shearing of healthy adult sheep or from lambs' first shearing and is processed for the first time (not recycled wool).

As the manufacturer, we reserve the right to differences in the upholstering process if required by the shape of the backrest or seat and the material properties (ductility, pliability). Please note that especially the Split 373 and 374 armchairs are in such case supplied with two vertical lines of stitches on the inner side of the backrest. The Malmö 332 chair has sewn side pieces in the sides of the bent areas if upholstered with Alcantara or natural leather. The Leaf chairs 437 and 439 have horizontal seams in the bent areas of the seat if upholstered with Alcantara and all artificial leathers. The seams can also be applied to the customer's upholstery if the delivered material is not sufficiently ductile.

### ■ Artificial leather

The basis of artificial leather is textile to which PUR, PVC layers or their mixtures are applied. A texture characteristic of natural leather (hide) may be printed onto this layer. Developments in the processing of artificial leather in modern times have resulted in artificial leather not being discernible from natural leather at first glance and thus enabling customers to enjoy the appearance

and comfort of leather at bargain prices. Further advantages of artificial leather include high abrasion resistance, water resistance and easy maintenance. These properties together with the fire retardant finish provide a wide range of applications of artificial leather in public areas, healthcare industry and in households.

## Leather

Leather is pliable and warm to the touch, permeable, elastic, has a characteristic scent and is resistant to wear. Its quality depends on the animal's lifestyle but also on how the leather was processed. Minor defects occurring during the animal's life, such as wrinkles, veins, small scars or scratches are regarded as permissible and are even required as an evidence of the ,genuine

Wrinkles



and unique' quality of the leather. Unacceptable defects are deep scratches, burn marks, thin skin and also defects originating from processing the leather. The long-term natural appearance of leather can be preserved by regular care and by following the few simple principles of use found in our Furniture care & maintenance manual.

Scars

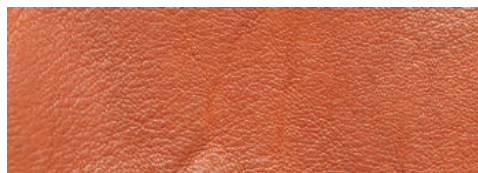

### ■ Aniline leather

This leather is processed with vegetable oils. Only water-soluble aniline dye is used to dye the leather so the surface of the leather is not treated with a pigment layer. The leather thus retains its open pores and natural permeability, softness and smoothness. Permeability increases user comfort. The temperature of the leather easily adapts to the temperature of the human body, thus eliminating the feeling of cold or unpleasant overheating. Aniline leather best manifests the natural character of leather. The non-uniform colour, natural flaws and individual surface pattern accentuate the originality of each piece. Elmotique is a thinner aniline leather with a tie-dye effect which shows all the properties of original leather.

### ■ Semi-aniline leather

Semi-aniline leather is dyed just like aniline leather. But a thin layer of pigment is applied to the surface to protect the leather from damage. For this reason, semi-aniline leather can also be

used in public environments. The pigment layer on the surface only partially reduces the permeability of the pores, it does not cover the natural marks of the leather and maintains the contrasting colours. Elmosoft is a soft and pliable semi-aniline leather which is available in a broad palette of shades. It fulfils applicability in the public sector according to the BS5852 Crib 5 Test.

### ■ Pigmented leather

Pigmented leather can also be dyed with aniline dyes. The epidermis may be brushed. The surface finish is a layer of pigment dye with an imprint of the uniform raster of the leather surface. This results in loss of natural permeability, reduction in softness and the ability to remove moisture. On the other hand, the pigment layers have very good wear resistance, colour-fastness, better resistance to soiling and are easier to maintain. Prince and MDR are pigmented leathers which fulfil the requirements of intensive usage of products that are easy and quick to maintain.

! For leather renovation, we recommend a special kit from the Swedish company Elmo, which you will find in the price list under the name Carekit Elmo and the identification code CB0002. The kit is suitable for all types of leather from our range.

! As the manufacturer, we reserve the right to differences in the upholstering process if required by the shape of the backrest or seat and the material properties (ductility, pliability). In case of natural leather upholstery, we draw your attention mainly to the Split 373 and 374 armchairs, which we supply with two vertical lines of stitches on the inner side of the backrest. The Malmö 332 chair has sewn side pieces in the sides of the bent areas. The Leaf 437 and 439 chairs have horizontal seams at the bends of the seat part. Exceptions may apply to the upholstery also in the case of natural leather sent by the customer!







! A product upholstered with aniline leather becomes a new member of the household which requires regular care and careful handling. Since the leather has no surface finish, it is susceptible to scratching, absorption of fluids and dirt. Direct sunlight is also harmful to it. In time, the surface acquires a characteristic patina.

! Thanks to the pigment layer, the surface finish of semi-aniline leather is more resistant to sunlight, scratching, stains and fluids. But this does not mean that it does not require regular care.



## Category A

### ■ Brunei

Composition	Width	Abrasion resistance	Pilling	Flame retardancy	Ecology	Cleaning
100% polyester	140 cm	30 000 MD	4	BS 5852 Part 1	Oeko-Tex	      

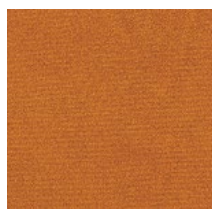

18



29



31





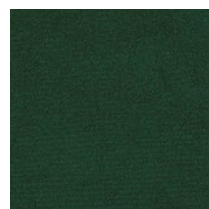

38



45

### ■ Fargo

Composition	Width	Abrasion resistance	Pilling	Flame retardancy	Ecology	Cleaning
100% polyester	142 cm	62 000 MD	4-5	EN 1021 Part 1	—	    

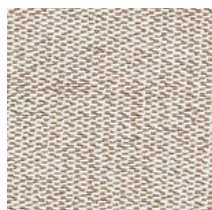

701



710

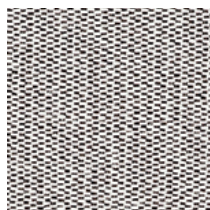

801

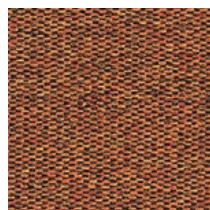

923

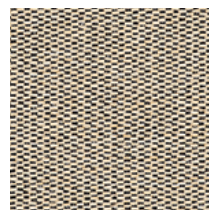



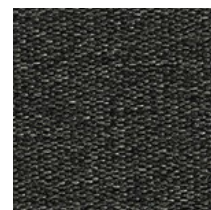

927



990

### ■ Harby

Composition	Width	Abrasion resistance	Pilling	Flame retardancy	Ecology	Cleaning
100% polyester	142 cm	62 000 MD	4-5	EN 1021 Part 1	—	    

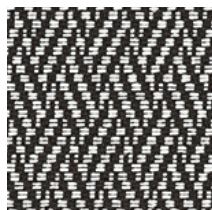

801

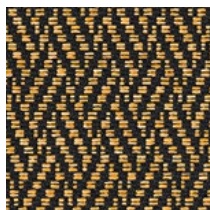

810











990





## Category A

### ■ Grain

Composition	Width	Abrasion resistance	Pilling	Flame retardancy	Ecology	Cleaning
surface 100% polyurethane	140 cm	200 000 MD	—	BS 5852 Part 1 California TB117-2013 EN 1021 Part 1 & 2	REACH	    
underlay 67% polyester, 33% cotton						  



arcilla 75

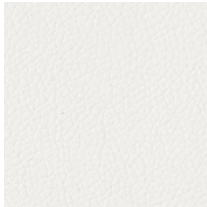

blanco 00



canela 11

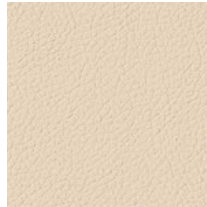

crema 02



gris 01



marino 69

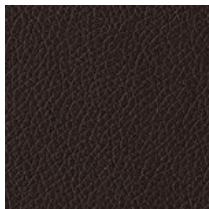

marron 23



negro 90

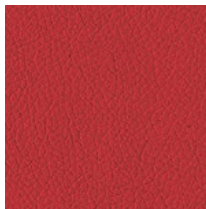

rojo 29









teja 15



tierra 07

## Category B

### ■ Jet Bioactive

Composition	Width	Abrasion resistance	Pilling	Flame retardancy	Ecology	Cleaning
100% Trevira® CS Bioactive	140 cm	65 000 MD	5	BS 5852 Crib 5 California TB117-2013 DIN 4102 Class B1 EN 1021 Part 1 & 2 NF 92501-7 Class M1 ÖNORM A 3800-1 Class Q1 ÖNORM B 3825	Oeko-Tex	     



8033

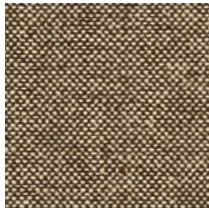

9109



9110

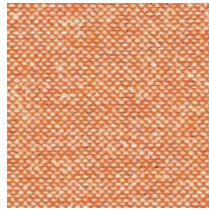

9301

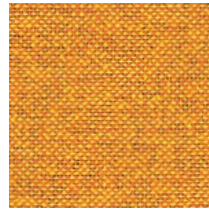

9304

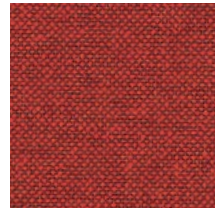

9401

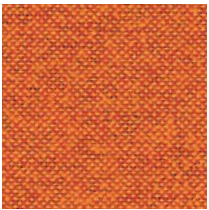

9403

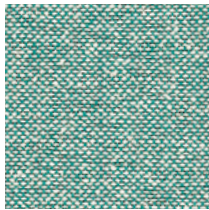

9610

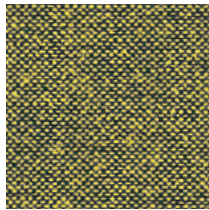



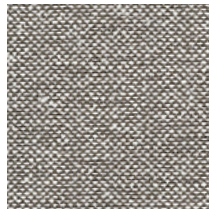

9702



9804

### ■ Torino

Composition	Width	Abrasion resistance	Pilling	Flame retardancy	Ecology	Cleaning
100% Trevira® CS	140 cm	70 000 MD	5	BS 5852 Crib 5 California TB117-2013 DIN 4102 Class B1 EN 1021 Part 1 & 2 NF 92501-7 Class M1 ÖNORM A 3800-1 Class B1,Q1,TR1 ÖNORM B 3825	Oeko-Tex	    

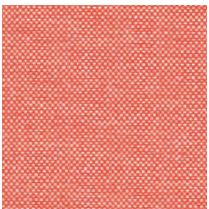

9401

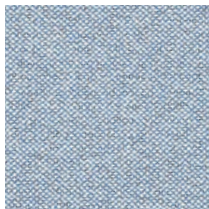

9601



9616



9701

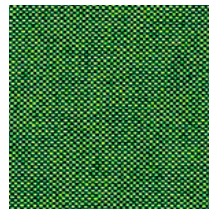



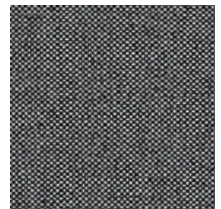







9707



9818

## Category B

### ■ Palma NF

Composition	Width	Abrasion resistance	Pilling	Flame retardancy	Ecology	Cleaning
surface 100% vinyl	137 cm	300 000 MD	—	BS 5852 Crib 5 California TB117-2013 DIN 4102 Part 1 Class B1 + B2 DIN 53438 Part 2 & 3 DIN 66084 P-a EN 1021 Part 1 & 2 NF P 92503 Class M1 ÖNORM A 3800-1 Class Q1 ÖNORM B 3825	REACH	    
underlay 100% cotton						    

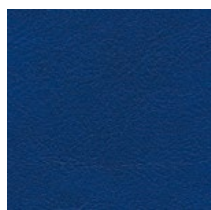

F6411005

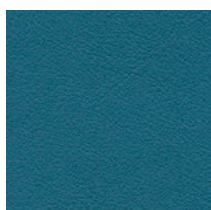

F6411006

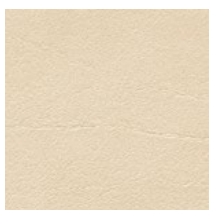

F6411008



F6411010

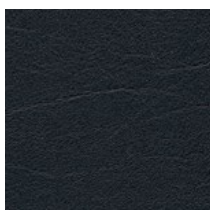

F6411011



F6411012

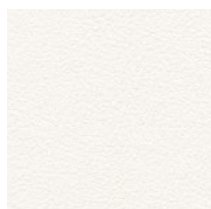

F6411143

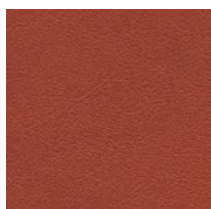

F6411144

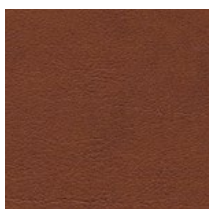

F6411145

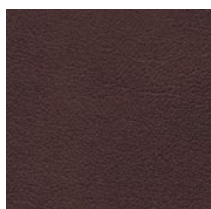

F6411146



F6411152

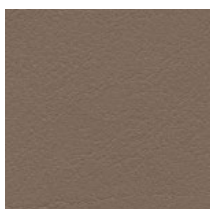

F6411153



F6411154



F6411155



F6411160

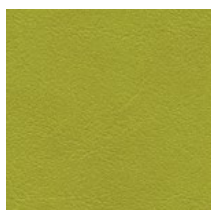

F6411195



F6411196



F6411197



F6411198



F6411199



We do not keep this material in stock. We order the required quantity for specific orders and there-

fore the lead time can be longer depending on the manufacturer's delivery terms.



! We provide a 2-year warranty for ■ Palma NF artificial leather.

## Category B

### ■ Silvertex®

Composition	Width	Abrasion resistance	Pilling	Flame retardancy	Ecology	Cleaning
surface 100% vinyl	137 cm	300 000 MD	—	California TB117-2013 DIN 4102 Class B2 EN 1021 Part 1 & 2	REACH	
underlay 100% polyester				NF P 92503 Class M2 ONORM A 3800-1 Class Q1 ONORM B 3825		

### ■ Silvertex® C5

Composition	Width	Abrasion resistance	Pilling	Flame retardancy	Ecology	Cleaning
surface 100% vinyl	137 cm	300 000 MD	—	BS 5852 Crib 5 California TB117-2013 DIN 4102 Class B2 EN 1021 Part 1 & 2	REACH	
underlay 100% cotton				NF P 92503 Class M2		



Aluminium 2101



Aubergine 7001 C5



Avocado 2092

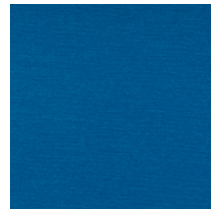

Baltic 3066 C5



Basil 5020 C5

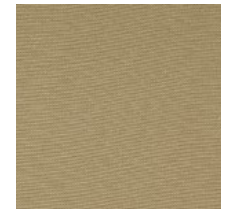

Beige 1010 C5



Black 9001



Bottle 5010



Camel 2105



Carbon 9002 C5



Celery 5019



Champagne 1078



Citrus 2091



Cobre 2003 C5



Coral 2102

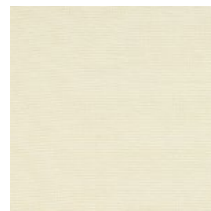

Cream 1077 C5



Delft 3067 C5



Forest 5063

## Category B

### ■ Silvertex®



Graphite 4003

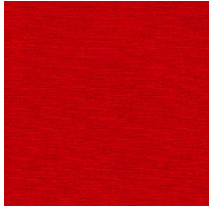

Grenadine 2095

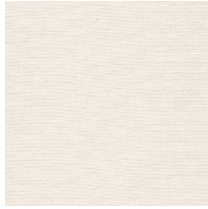

Ice 4004

C5



Ice Cream 2090



Jet 3068



Lotus 2099



Luggage 0073



Macadamia 0001

C5



Magenta 7002

C5



Mandarin 6061

C5

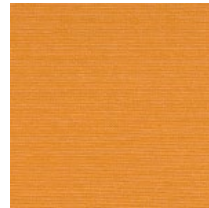

Melon 6062



Meteor 4024

C5



Mocca 0005

C5



Orange 0013



Orchid 2097



Petrol 2094



Pistacho 5008

C5



Plata 4001

C5



Raspberry 2016



Red 2011

C5



Rosé 2098



Rubin 6004

C5

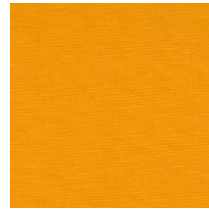

Safran 6065

C5



Sage 5009



Sandstone 0002

C5



Sapphire 3007

C5



Shiitake 4012



Sisal 1051

C5



Skylight 2103



Squash 2093

2



## Category B

### ■ Silvertex®



Sterling 4011



Storm 4002 C5



Sunkist 2012



Taupe 0009 C5



Teal 2100



Titanium 4010



Tomato 2096



Turquoise 3001 C5



Ultra Violet 2104



Umber 1014



White 2089











Wine 2064

We do not keep this material in stock. We order the required quantity for specific orders and therefore the lead time can be longer depending on the manufacturer's delivery terms.

Colours without C5 do not pass the fire-retardant test BS 5852 Crib 5.









### ■ Ginkgo

Composition	Width	Abrasion resistance	Pilling	Flame retardancy	Ecology	Cleaning
surface 100% vinyl	140 cm	150 000 MD	—	BS 5852 Crib 5 California TB117-2013 DIN 4102 Class B2 EN 1021 Part 1 & 2 NF P 92503 Class M1 NF P 92504 Class M1 Önorm A 3800-1 Class Q1 Önorm B 3825	REACH	       

The artificial leather Ginkgo can be ordered in all colour shades according to the manufacturer's swatches. We do not keep this material in stock. We order the required quantity for specific orders and therefore the lead time can be longer depending on the manufacturer's delivery terms.

## Category C

### ■ Ambra

Composition	Width	Abrasion resistance	Pilling	Flame retardancy	Ecology	Cleaning
100% polyester	134 cm	60 000 MD	5	BS 5852 Crib 5 California TB117-2013 EN 1021 Part 1 & 2	—	        

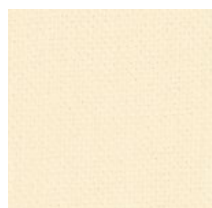

1550



1551



1552



2550

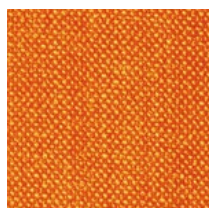

3550

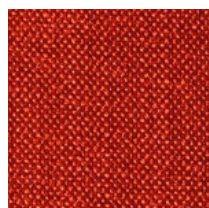

3551



4550

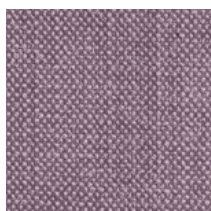

4551

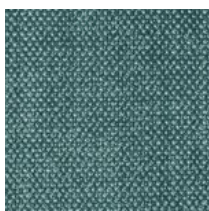

5550

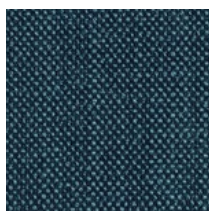

5551



5552

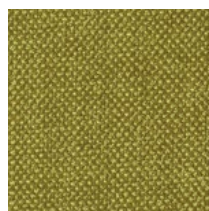

6550



6551



7550



7551



7552

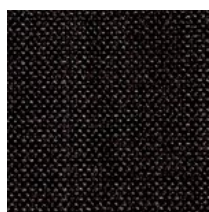

8550



8551



8552



8553

We do not keep this material in stock. We order the required quantity for specific orders and therefore the lead time can be longer depending on the manufacturer's delivery terms.

! Occasional stains or colour changes of Ambra fabric are not a sign of product defect.

## Category C

### ■ Garda

Composition	Width	Abrasion resistance	Pilling	Flame retardancy	Ecology	Cleaning
100% Trevira® CS	140 cm	80 000 MD	5	BS 5852 Crib 5 California TB117-2013 DIN 4102 Class B1 EN 1021 Class 1 & 2 NF 92503 Class M1 ÖNORM A 3800-1 Class B1,Q1,TR1 ÖNORM B 3825	Oeko-Tex	



9301

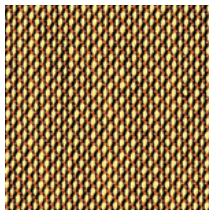

9307

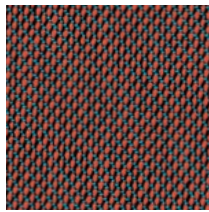

9406

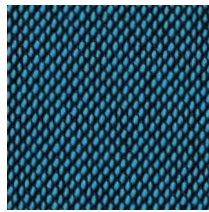

9616

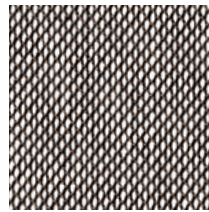

9808

### ■ Lowlands Plain

Composition	Width	Abrasion resistance	Pilling	Flame retardancy	Ecology	Cleaning
70% recycled wool, 30% polyamide	140 cm	190 000 MD	3	BS 5852 Crib 5 California TB117-2013 EN 1021 Part 1 & 2	REACH	



513



516

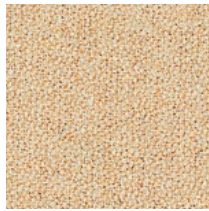

521



524



529



531

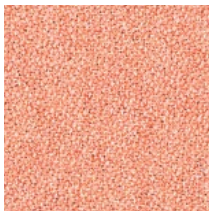

541

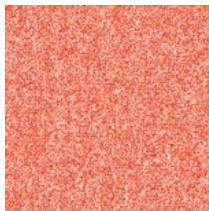

542

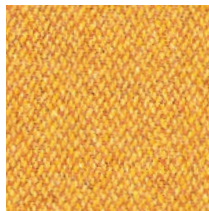

562

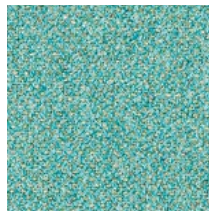

571



572



581



585

## Category D

### ■ Dante

Composition	Width	Abrasion resistance	Pilling	Flame retardancy	Ecology	Cleaning
95% virgin wool, 5% polyamide	140 cm	52 000 MD	4-5	BS 5852 Crib 5 California TB117-2013 DIN 4102 Class B2 EN 1021 Part 1 & 2	RAL-UZ 117 Appendix 2+3 REACH	



black



chrom



lanoso

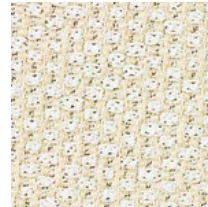

snow

### ■ Mica

Composition	Width	Abrasion resistance	Pilling	Flame retardancy	Ecology	Cleaning
95% virgin wool, 5% polyamide	140 cm	70 000 MD	4-5	BS 5852 Crib 5 California TB117-2013 DIN 4102 Class B2 EN 1021 Part 1 & 2	RAL-UZ 117 Appendix 2+3 REACH	

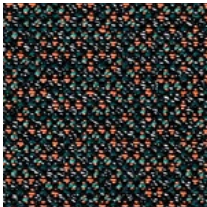

arion

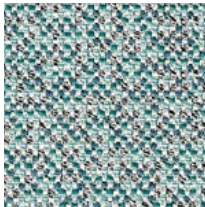

aqua

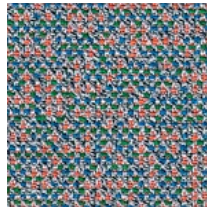

papillon

## Category D

### ■ Milkyway

Composition	Width	Abrasion resistance	Pilling	Flame retardancy	Ecology	Cleaning
94% virgin wool, 6% polyamide	150 cm	50 000 MD	5	BS 5852 Crib 5 California TB117-2013 DIN 4102 Class B2 EN 1021 Part 1 & 2	RAL-UZ 117 Appendix 2+3 REACH	

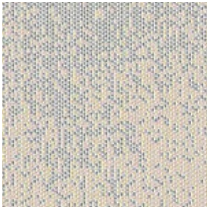

powder

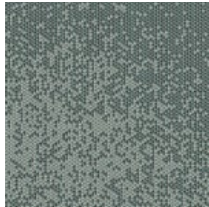

jade

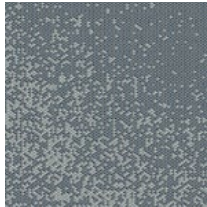

shadow

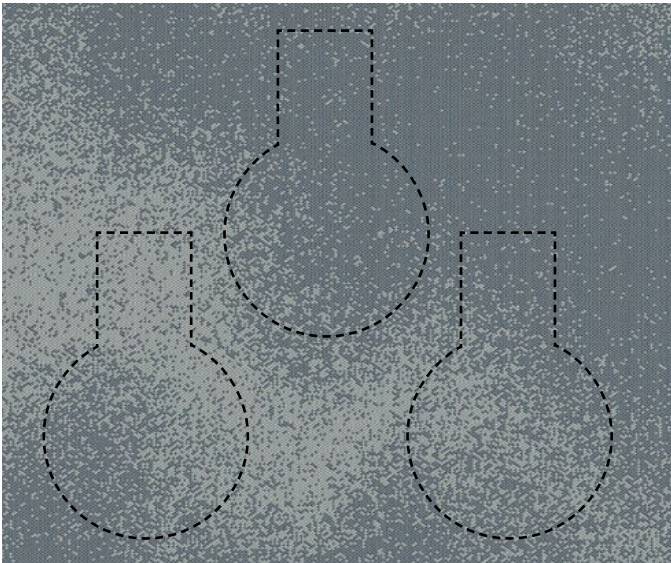

! A high-quality fabric made from wool featuring the cosmic pattern of the Milky Way. Given the changing nature of the pattern, which repeats every three meters, each upholstered piece of furniture is an original – yet clearly part of the celestial colour scheme.

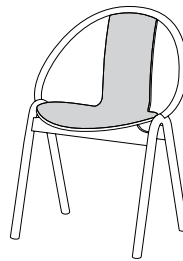

### ■ Sand

Composition	Width	Abrasion resistance	Pilling	Flame retardancy	Ecology	Cleaning
100% Trevira® CS	140 cm	50 000 MD	4	BS 5852 Crib 5 California TB117-2013 DIN 4102 Class B1 EN 1021 Part 1 & 2 NF P 92504 Class M1 NF P 92507 Class M1 ÖNORM B 3825	Oeko-Tex	



01/90



02/00



06/78



07/88

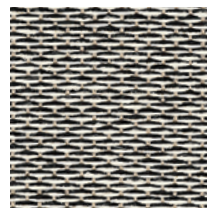

10/80

## Category D

### ■ Sera

Composition	Width	Abrasion resistance	Pilling	Flame retardancy	Ecology	Cleaning
94% virgin wool, 6% polyamide	140 cm	122 000 MD	4-5	BS 5852 Crib 5 California TB117-2013 DIN 4102 Class B2 EN 1021 Part 1 & 2	RAL-UZ 117 Appendix 2+3 REACH	

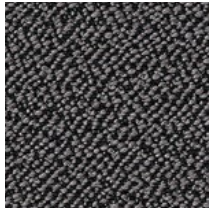

anthrazit



calla

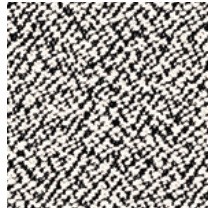

pepper

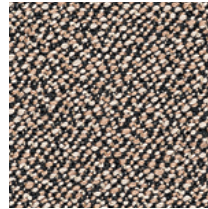

walnut

### ■ Topia

Composition	Width	Abrasion resistance	Pilling	Flame retardancy	Ecology	Cleaning
95% virgin wool, 5% polyamide	150 cm	50 000 MD	4-5	BS 5852 Crib 5 California TB117-2013 DIN 4102 Class B2 EN 1021 Part 1 & 2	RAL-UZ 117 Appendix 2+3 REACH	



bronze

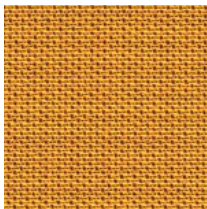

curry

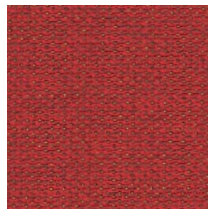

heart

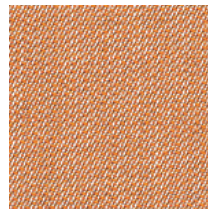

messing

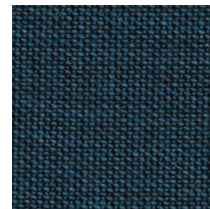

orion

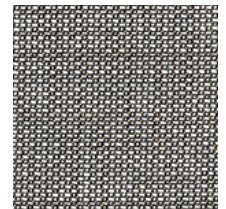

platin

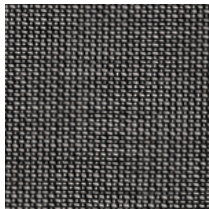

schiefer

## Category D

### Walker

Composition	Width	Abrasion resistance	Pilling	Flame retardancy	Ecology	Cleaning
100% Trevira® CS	150 cm	45 000 MD	5	BS 5852 Crib 5 California TB117-2013 DIN 4102 Class B1 EN 1021 Class 1 & 2 NF P 92503 M1 NF P 92507 M1	Oeko-Tex	

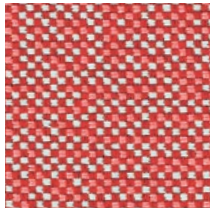

01

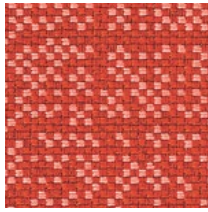

10

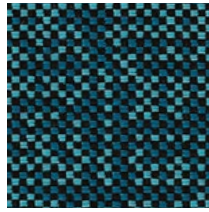

40

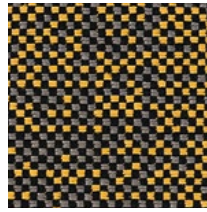

68

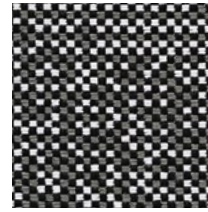

80

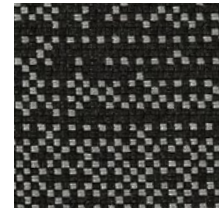

88

## Category E

### Alcantara® Avant

Composition	Width	Abrasion resistance	Pilling	Flame retardancy	Ecology	Cleaning
68% polyester, 32% polyurethane	142 cm	150 000 MD	—	BS 5852 Crib 5 EN 1021 Part 1 & 2	Oeko-Tex	

Included in this price group is Alcantara fabric, which can be ordered in all colours listed in the manufacturer's sample book. We do not keep this material in stock. We order the required quantity

for specific orders and therefore the lead time can be longer depending on the manufacturer's delivery terms.

## Category 1

### MDR\*

Type of leather	Size	Thickness	Flame retardancy	Ecology	Cleaning
pigmented leather	± 4 m <sup>2</sup>	0,80-1,00 mm	BS 5852 Part 0 & 1 California TB117-2013 EN 1021 Part 1 & 2	REACH	



0000



31174



70386



71295

## Category 1

### ■ Prince\*

Type of leather	Size	Thickness	Flame retardancy	Ecology	Cleaning
pigmented leather	± 3,9 m <sup>2</sup>	0,90-1 mm	BS 5852 Part 0 & 1 California TB117-2013 EN 1021 Part 1 & 2	REACH	

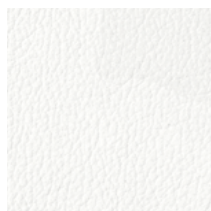

171

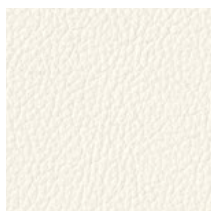

179

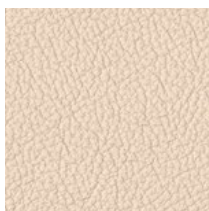

180



188

## Category 2

### ■ Elmotique\*

Type of leather	Size	Thickness	Flame retardancy	Ecology	Cleaning
aniline leather	± 5 m <sup>2</sup>	1,00-1,20 mm	California TB117-2013 EN 1021 Part 1 & 2 ISO 8191 Part 1 & 2	REACH	

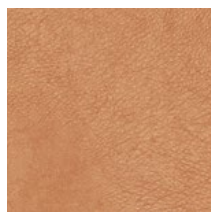

43024



43807



93957

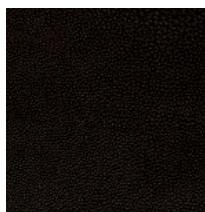

99001

### ■ Elmosoft\*

Type of leather	Size	Thickness	Flame retardancy	Ecology	Cleaning
semi-aniline leather	± 5 m <sup>2</sup>	1,10-1,30 mm	BS 5852 Crib 5 California TB117-2013 DIN 4102 Class B1 EN 1021 Part 1 & 2 ISO 8191 Part 1 & 2 NF P 92503 Class M2 ÖNORM B 3825	REACH	

Elmosoft leather can be ordered in all colour shades according to the manufacturer's swatches. We do not keep this material in stock. We order





the required quantity for specific orders and therefore the lead time can be longer depending on the manufacturer's delivery terms.

\* When using Elmosoft and shades of Prince, MDR and Elmotique outside of the TON standard selection, we reserve the right to charge the customer for any leftover leather in the hide. A hide size varies between 3.5-5.5 m<sup>2</sup>.



## Mesh

### ■ Polo

Composition	Width	Abrasion resistance	Pilling	Flame retardancy	Ecology	Cleaning
100% polyester	150 cm	100 000 MD	5	—	Oeko-Tex	    

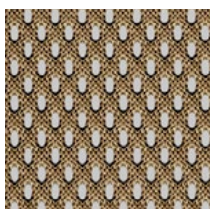

beige 6



bianco 5



bleu 8



castoro 7



grigio 2

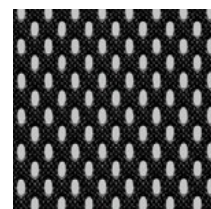

nero 1



piombo 9

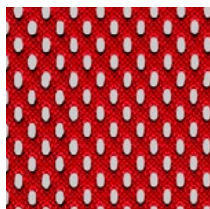

rosso 10

Polo: an airy textile mesh which is used for back part of Chips lounge chair. It can also be used as an alternative to the cane seats and backs on classic bentwood models.

If used on a seat the Polo mesh is always combined with special underlay material for increased durability.

! The reinforcement mesh cannot be supplied on orders to Germany, Austria, Belgium, Switzerland, Luxembourg, the Netherlands and Liechtenstein.

## Technical data

■ **Abrasion resistance** / The capability of upholstery materials to resist abrasive effects during the product use. Abrasion resistance is indicated in MD\* units – EN 12947-2. The average MD value for HORECA market is 30 000 MD.

■ **Pilling** / Pilling can occur when materials, both natural and synthetic, rub against each other. It is an inherent feature of materials and has no effect on the fabric's function or durability. This feature is tested using the Martindale method modified according to the EN 12945-2 standard. The tested sample is then assessed on the scale of 1 to 5 (5 – almost no change; 4 – slight changes or pilling in an initial stage).

■ **Flame retardancy** / The upholstery material has the ability to extinguish itself as soon as the source of fire is removed. This means that the combination of upholstery material and filling may burn when exposed to direct fire but, when the source of fire is removed, the burning will stop immediately. There are a great many regulations on testing fire resistance. To ensure the greatest possible protection, we recommend combining a self-extinguishing upholstery material with PUR foam with the same qualities – see "Self-extinguishing PUR foam" on p. 43.

■ **Ecology** / Oeko-Tex Standard 100 is a testing and certification system assessing the fabric's health safety. Test samples are tested for the presence of pesticides, heavy metals, formaldehyde, carcinogenic dyes, etc. REACH is an abbreviation which expresses the approach of EU Member States to chemical substances particularly in connection with protection of human health and the environment. The focus of interest are all chemical substances, particularly toxic, carcinogenic, mutagenic substances, etc. The most dangerous ones are subsequently placed on the list of banned substances (for instance, Lead, Nickel, Phthalates). The REACH Directive stipulates the obligation of manufacturers to prove the use of safe chemical substances and to provide consumers with information about the use of dangerous substances. RAL-UZ 117 are criteria stipulated in the Federal Republic of Germany for the assessment of upholstered furniture in terms of environmental protection, public health and service life. Environmentally-friendly products and materials are then marked with the "Der Blaue Engel" (Blue Angel) symbol.

■ **Cleaning** / Cleaning symbols provide information on the proper care of the material so that it is not permanently damaged by unsuitable care.

\* MD unit (Martindale) represents one special movement of the machine which is testing the surface of textiles. The number of MD units represents the number of cycles during the testing up to the moment when the first fibre on the tested textile tears.

! Light colours of fabrics, artificial and natural leathers can be stained when in contact with other materials (non-colourfast textiles, denim, newspapers, magazines etc.). Staining by chemical reaction of colour pigments is not a sign of low quality of upholstery materials and therefore cannot be covered by warranty or claimed.

! Slight ripples and wrinkles can appear on upholstered products during the upholstery process or during the use of the product. These ripples or wrinkles can be determined by the characteristics of upholstery materials or upholstery technology and therefore cannot be subject to any claim.

### List of symbols

 Machine wash at a maximum temperature of 95 °C and normal agitation. Normal rinsing and normal spinning.

 Machine wash at a maximum temperature of 60 °C with reduced agitation. Rinsing in water of decreasing temperature and gentle spinning.

 Normal mechanical washing in a washing machine at a maximum temperature of 60 °C. Normal rinsing and spinning.

 Machine wash at a maximum temperature of 40 °C and very limited agitation. Gentle rinsing and gentle spinning. No hand wringing.

 Machine wash at a maximum temperature of 30 °C and normal agitation. Normal rinsing and normal spinning.

 Machine wash at a maximum temperature of 30 °C and very limited agitation. Normal rinsing and gentle spinning.

 Do not wash.

 Bleaching products releasing chlorine can be used. Use diluted cold solution only.

 No bleaching products releasing chlorine can be used.

 Can be tumble dried at a medium heat setting.

 Drying in a drum dryer with a mild drying programme at a lower temperature.

 Do not dry in a tumble dryer.

 Maximum iron temperature 150 °C.

 Maximum iron temperature 110 °C. Caution when using steam iron.

 Cannot be ironed, steamed or otherwise treated with steam.

 Can be dry-cleaned with tetrachlorethene (perchloroethylene) or solvents under a similar symbol with the letter F. No cleaning process restriction.

 Can be dry-cleaned with tetrachlorethene (perchloroethylene) or solvents under a similar symbol with the letter F with limited water added, with limited agitation or with limited drying temperature.

 Upholstery cannot be cleaned chemically. Do not remove stains with organic solvents.

 Hand wash on 40 °C.

⊕ Healthcare

💧 Water resistant

🩸 Blood and urine resistant

🧼 Easy to clean

🧴 Desinfectant resistant

🦠 Antimicrobial

🚢 Maritime sector

---

## Customer's own material

If our range of upholstery materials does not meet your needs, you can provide your own material. The required amount of material as stated in the price list is calculated per piece on orders of more than 10 pieces. For orders of 1 to 10 pieces, the required amount should be consulted with a sales representative. For fabrics and vinyls, the calculation in the price list is based on material width of 140 cm. If you have a material with a different width, we recommend that you contact a sales representative to confirm the amount of material required.

When upholstering furniture we work with the customary direction of a pattern, which can influence the final look of the upholstery. When supplying fabric with a distinctive pattern, we recommend that customers consult with us in advance to agree on the way the pattern is to be used.

! Fabrics, artificial leathers and natural leathers should be sent in rolls only. Artificial leather and natural leather in particular can be subject to deformation when folded and such damage can be irreversible!

! In case of COM, mark distinctly what shall be the face side. If the customer's fabric is chequered, striped or is of another special design which can be upholstered both horizontally and vertically, indicate how you wish to place the design on the seat and backrest. In this case, the material consumption can be higher than expected. If the face side or the direction of upholstering is not marked, we reserve the right to determine it by ourselves.

! Regarding upholstery with customer's own material (COM), we reserve the right to refuse any material which is not suitable for upholstery of our seating furniture or is not delivered in the requested state.

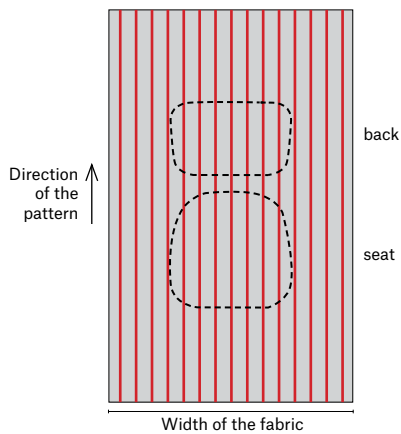

---

## Decorative stitching

The Split lounge armchair features decorative stitching along the top edge of the backrest and the armrests. The customer chooses the colour of the stitching and has the option to either highlight or downplay this decorative element.



---

## Sale by the metre

Fabrics and artificial and natural leather are also available for sale by the metre. Provided the required material is in stock in an adequate quantity, we can dispatch it within 5 days. If not, the lead time depends on the delivery terms of our supplier

and could be between 2 and 4 weeks. For fabrics and artificial leather, the minimum order quantity is 0.5 m. Leather can be ordered only in pieces, i.e. about 4 to 5 square metres. The current price will be given to you by the seller.

---

## Flame retardant PUR foam

The basic option for all TON's upholstered products includes self-extinguishing PUR foam that complies with standard CAL 117. There are many different regulations for testing fire resistance. The British standard BS 5852 Crib 5, which sets high criteria for self-extinguishing, is widely recognised. TON can supply PUR foams complying with the requirements of this standard for an additional fee. Additional fees can be found in the price list.

Selected products have self-extinguishing BS 5852 Crib 5 foam as standard. In these instances, the price list does not state a supplement but uses the \* symbol. To ensure the greatest possible protection, we recommend combining self-extinguishing PUR foam with an appropriate fabric that complies either with the CAL 117 standard or with British standard BS 5852 Crib 5.

---

## Decorative nails

Upholstery of selected models can be complemented by decorative nails, especially if upholstered with artificial or natural leather. Antique bronze is our standard nail. Surcharge for decorative nails is listed for applicable models in the price list.



Decorative nails

! Please note that small fragments of plastic material that was used to position the nails may appear around the decorative nails.

# customisation

## Embossed seats and backrests

Embossed seats/backrests can be used on selected models from the classical bentwood collection. Possibilities of the embossed seats/backrests are

listed in the price list. These seats and backrests are not subjected to a surcharge.



**Embossed seat 202**  
Model 014, 018, 030, 033, 060, 073, 132, 134, 378, 503, 505, 523



**Embossed seat 203**  
Model 004, 020, 024, 025, 054, 056, 130, 131, 135, 149, 150, 763, 769



**Embossed seat 255**  
Model 004, 020, 024, 025, 054, 056, 130, 131, 135, 149, 150, 763, 769



**Embossed seat 206**  
Model 014, 018, 030, 033, 060, 073, 132, 134, 378, 503, 505, 523



**Embossed seat 209**  
Model 004, 020, 024, 025, 054, 056, 130, 131, 135, 149, 150, 763, 769



**Embossed seat 256**  
Model 004, 020, 024, 025, 054, 056, 130, 131, 135, 149, 150, 763, 769



**Embossed seat 219**  
Model 014, 018, 060, 073, 132, 134, 378, 505



**Embossed seat 223**  
Model 004, 020, 024, 025, 054, 056, 130, 131, 135, 149, 150, 763, 769



**Embossed seat 259**  
Model 014, 018, 030, 033, 060, 073, 132, 134, 378, 503, 505, 523



**Embossed backrest 208**  
Model 054



**Embossed backrest 223**  
Model 054

## Glides

Glides protect the product material as well as the floor against damage, can reduce noise and help to make moving the chair on the floor easier, especially on carpets. Specify the required type of glides to suit your floor in your order. You can follow our recommendations, but please bear in mind that these are merely informative and not binding. If you are not sure which type of glides to

choose, request an opinion from your floor covering supplier.

We supply felt glides in white or black colour.

Teflon glides are gentler on floors than other types of glides. They are suitable for laminate, cork and vinyl floors, tiles, carpeting and linoleum. We have Teflon glides in grey colour.

### ■ Type of glides - type of floor:

Teflon glides - laminate, cork and vinyl floors, tiles, carpeting, linoleum

Felt glides - wooden floors

#### Felt glides



#### Teflon glide



(illustrative image)

! We recommend that customers check the wear and condition of their furniture glides once every six months, especially with glides made from felt and Teflon. If glides need replacing, customers should contact their sales representative.

! Note that dimensions of the products are given without the glides. The glides can thus additionally affect the overall height and the height of the seat by 4-12 mm.

! Our offer includes products that have a pre-determined type of glides or products where a standard glide cannot be offered (the Kontor\_503 & 523, swivel chair, the Piano\_505 swivel stool, rocking chairs, coat stands, benches, etc.).

! The quality warranty cannot be applied to wear of glides when used in unsuitable conditions or at excessive load (unevenness of the floor, rustic character of the floor, perpendicular direction of the planks in the floor to the direction of chair movement, etc.).

## Cane weave

Cane weave has been used in an almost unchanged form since the revival of the technique at the turn of the twentieth century. Chairs made from bentwood with cane seats or backrests are light, airy and comfortable to sit on, especially in the summer. The cane weave is made from purely natural material, is easy to maintain and can be renovated at any time.

Today, ready-made cane sheets are used instead of hand-weaving. These are made from the inner part of the stem of rattan liana from the forests of Southeast Asia. Before being processed, the cane sheet is moistened to become flexible and then it is pressed into a groove in the seat or backrest by twisted rattan strings. Drying up, the weave shrinks back to its original size. Rattan fibres natu-

rally split and fray. However, during the processing, the weave surface is cleaned up with a special electric machine. We offer the cane weave in natural or Antique finish.

To increase the strength and durability of natural cane weave, we recommend application of additional plastic weave (reinforcement mesh). The reinforcement mesh is stable, holds its shape and prevents excessive stretching of the cane weave on the seat, which may eventually lead to rupture. The additional mesh can only be used on the seat. We offer the mesh in black and white colour for a surcharge specified in the price list. Due to technological reasons, only black reinforcement mesh is available for the cane seat in Antique finish.



Top side (without mesh)



Top side (without mesh)



Top side (with white mesh)



Top side (with black mesh)



Underside (with white reinforcement mesh)



Underside (with black reinforcement mesh)

! We provide a warranty in accordance with the GTC for products with cane components.

! To protect the fibres from cracking and the weave from getting damaged, do not expose cane products to high temperatures and low air humidity.

! Both versions of the cane weave can be treated following the guidelines specified in the Furniture Care & Maintenance manual. Neither of the versions should be subjected to excessive pressure in one spot to prevent rupture of the weave.

! For commercial premises where products are exposed to heavy use, we recommend use of reinforcement mesh underneath the cane weave.

! The reinforcement mesh cannot be supplied on orders to Germany, Austria, Belgium, Switzerland, Luxembourg, the Netherlands and Liechtenstein.

! Just like the wood in our products, cane is a natural material with slight colour variations. Possible darker colouring of the cane weave (including of individual fibres) is not a defect and therefore not a cause for complaint. Indeed, it is proof of the material's natural origin.

! Antique cane weave incurs a surcharge that is specified in the price list next to the heading Antique.

! Antique cane weave can only be used with products finished with stains B4, B105, B112, B123, B130/A.

## Barstools

All our barstools are also available in lower versions, which may be appreciated especially by people who wish to use them at their kitchen counters. The reduced sitting height has been selected with respect to the chair's construction, safety and aesthetic appearance. In your order, simply state whether you want a high or a low barstool. Prices and surcharges are identical for both versions. Dimensions are listed in the technical information in the price list.

### ■ Footrest plate

With most barstools we offer a steel footrest plate in black or silver colour to protect the footrest from wear. This option incurs a surcharge. The shape and quantity of required plates varies by model. The surcharge stated in the price list is always for the full quantity required for the selected product.

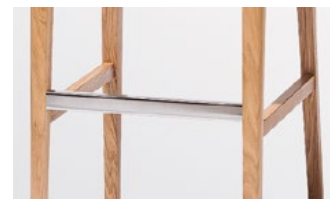

Footrest plate

! With the Rioja and Prag barstools, the price is for 4 footrest plates; with the Stockholm barstool it is for 2 plates. The number of footrest plates is determined by the number of directions from which one can be seated on a specific barstool.





---

## Connection into rows

Merano chairs are offered with a simple **Merano link** connecting set. Individual parts of the set are placed on the side of the backrest support legs

and may be easily linked or unlinked. The connecting set enables stacking of the chairs. The surcharge per one set is listed in the price list.

### ■ Side cover

In addition to the connecting set, we also offer covers for the connection parts of the first and last chairs in the row. The covers can be marked with laser-cut numbers that designate the order

of individual rows. The covers are supplied in the same colour finish as the chairs. The cover can be found in the price list under reference number 309 279. The price is quoted per one set.



Side cover



Connection into rows – detail

## Transport trolleys

For transport of stacked Merano chairs and P.O.V. stools we recommend the use of specially designed transport trolleys.

### ■ Merano trolley

The trolley will carry up to 14 non-upholstered chairs and will move through doors that are at least 60 cm wide. The back wheels are easily lockable. The trolley is available only in B123-black grain finish and can be found under code 799 405 in the price list.



! If the Merano chairs are standing on the floor, they can be stacked up to a maximum of 5 chairs.

! The total height of the Merano trolley with stacked chairs with veneer seat is 200 cm.

### ■ P.O.V. stool trolley

This minimalist, discreet trolley can stack up to 10 stools. The trolley is 40 cm wide, making it ideal for narrow spaces, and comes equipped with swivel wheels for easy movement. The trolley is available in B123-black grain finish and can be found under code 799 458 in the price list.



! The total height of the P.O.V. trolley carrying 10 non-upholstered stools is 168.5 cm; the total height with 10 upholstered stools is 183 cm.

---

## Stackability

Some chairs, armchairs or barstools can be stacked one on top of the other. In the price list, stackability is marked by a number, which represents the maximum quantity of stacked chairs. As a standard, products with veneer seats are supplied with plastic stops, which significantly decrease the risk of damage in the course of frequent handling.



! Pressure marks on upholstered seat or backrest caused by stacking cannot be subject to a claim.

---

## Interlays

To prevent the creation of pressure marks on upholstered seats as a result of stacking, we recommend the use of wooden interlays. These have been created for the Bergamo, Treviso, Lyon, Merano, Stockholm and Valencia models.



---

## Ornaments

Another option how to change appearance of a standard design of respective models is the application of the ornament on the chair backrest or seat (engraving). Engraved ornaments are made by laser on the outer side of the backrest into the depth of approximately 1 mm. This option can give some kind of originality to the

product, which may be interesting especially for gastronomic facilities.

Engraving is done at customer's request. For engraving surcharges listed in the price list, the minimum order is 20 pieces.

Engraving is also possible on smaller orders, with surcharge calculated on a per-order basis.

! When ordering ornaments, please specify their size and placement. Lead time and price for application of more complex designs are subject to an individual agreement.

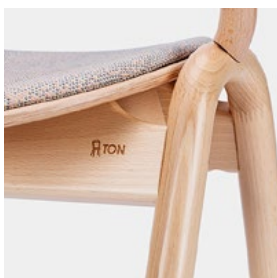

Detail of engraving – light colour finishes

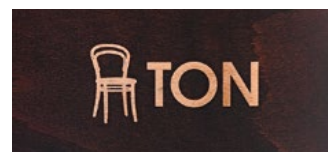

Detail of engraving – dark colour finishes

---

## Ready-to-ship products

Our most popular products are often in stock and ready to ship. We recommend monitoring current stock levels on our website or contacting a sales representative. Ready-to-ship products are fitted with Teflon glides, which are suitable for most types of flooring. Teflon glides can be exchanged

for other types of glides or footrest plates for an additional. Some of the ready-to-ship products can also be upholstered. If the chosen upholstery material is in stock, the finished product can be shipped within 2–3 weeks.

## Leg connections

You can find codes of leg connections in the description of models in our sales quotes, order confirmations and other documents. We show their schematic drawings for illustration.

! As part of ongoing care for your furniture, we recommend that you regularly check and, if necessary, tighten the screws. At a minimum, this should be done once every six months.

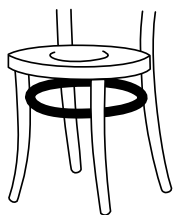

**01**  
Chair: 060, 811  
Children's chair: 014  
Armchair: 004, 020, 030, 033, 811  
Barstool: 372, 438, 439, 691



**02**  
Chair: 004, 014, 018, 020, 378

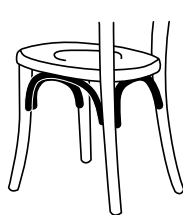

**22**  
Chair: 020, 054, 056, 150, 763, 769  
Armchair: 020, 024, 025



**23**  
Chair: 020, 054, 056, 763, 769  
Armchair: 020



**27**  
Chair: 004, 014, 018, 020, 056, 150, 378, 763, 769, 811  
Armchair: 004, 020, 024, 025, 030, 033, 811



**28**  
Chair: 004, 014, 018, 020, 054, 056, 378, 763, 769  
Armchair: 004, 020



**49**  
Barstool: 130, 131, 135



**50**  
Barstool: 130, 131



**51**  
Barstool: 130, 131, 135



**52**  
Barstool: 130, 131



**55**  
Barstool: 132, 134, 149, 813



**62**  
Chair: 763  
Armchair: 024, 025



**63**  
Chair: 763



**64**  
Barstool: 132, 134

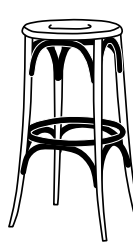

**70**  
Barstool: 073



**91**  
Barstool: 813



**14**  
Chair: 488



**37**  
Chair: 382, 516, 710, 713

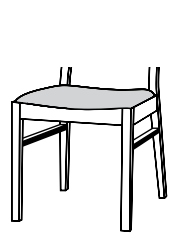

**37**  
Chair: 514

We recommend that customers consult with us leg connections in advance.

002

Jaroslav Juřica

04

TON R&amp;D



PRODUCT NUMBER	311 002	313 002	311 004	313 004	315 004	321 004
Type	chair	chair	chair	chair	chair	armchair
Seat option	veneer	upholstery	veneer	upholstery	cane/mesh Polo	veneer
Back option						
Type of wood	beech	beech	beech	beech	beech	beech
<b>PRICES IN € (VAT NOT INCLUDED)</b>						
Veneer seat	428,00		567,00			835,00
Upholstery - category A		543,00		583,00		
Upholstery - category B		550,00		587,00		
Upholstery - category C		556,00		590,00		
Upholstery - category D		569,00		598,00		
Upholstery - category E		602,00		616,00		
Upholstery - category 1		598,00		617,00		
Upholstery - category 2		669,00		659,00		
Upholstery - COM		537,00		580,00		
Cane					640,00	
Mesh Polo					668,00	
<b>SURCHARGES IN € (VAT NOT INCLUDED)</b>						
Antique colour	13,00	13,00	20,00	20,00	20,00	22,00
Pigment colours	34,00	34,00	34,00	34,00	34,00	36,00
Socks			15,00	15,00	15,00	15,00
Foam BS 5852 Crib 5		5,00		5,00		
Decorative nails				29,00		
Reinforcement mesh					28,00	
Footrest plate						
Connection into rows						
Engraving						
<b>TECHNICAL INFORMATION</b>						
Total width (cm)	57	57	41	41	41	51,5
Total depth (cm)	56	56	55	55	55	59
Total height (cm)	85	85	87	87	87	87
Armrest height (cm)						66
Seat height (cm)	45	47	46	46	46	46
Width of seat (cm)	49	49	39,5	39,5	39,5	42,5
Depth of seat (cm)	45	45	40,5	40,5	40,5	45,5
Weight of product (kg)	4,4	4,5	3,2	3,5	3,2	4,2
Consumption of fabric (m)		0,329		0,182		
Consumption of leather (m <sup>2</sup> )		0,880		0,528		
Packing (pcs)	1	1	2	2	2	1
Volume (m <sup>3</sup> /pc)	0,358	0,358	0,168	0,168	0,168	0,345
Carton dimensions (cm)	59 × 58 × 91	59 × 58 × 91	64 × 45 × 101	64 × 45 × 101	64 × 45 × 101	61 × 54 × 91
Bicolour	✓					
Stackability						
Embossed seat/backrest			203, 209, 223, 255, 256			203, 209, 223, 255, 256

04

TON R&amp;D

14

TON R&amp;D



PRODUCT NUMBER	323 004	325 004	311 014	313 014	315 014	311 134
Type	armchair	armchair	chair	chair	chair	barstool
Seat option	upholstery	cane/mesh Polo	veneer	upholstery	cane/mesh Polo	veneer
Back option						
Type of wood	beech	beech	beech	beech	beech	beech
<b>PRICES IN € (VAT NOT INCLUDED)</b>						
Veneer seat			300,00			360,00
Upholstery - category A	854,00			321,00		
Upholstery - category B	860,00			325,00		
Upholstery - category C	865,00			328,00		
Upholstery - category D	877,00			335,00		
Upholstery - category E	906,00			353,00		
Upholstery - category 1	893,00			354,00		
Upholstery - category 2	946,00			397,00		
Upholstery - COM	848,00			317,00		
Cane		907,00			361,00	
Mesh Polo		935,00			389,00	
<b>SURCHARGES IN € (VAT NOT INCLUDED)</b>						
Antique colour	22,00	22,00	19,00	19,00	19,00	23,00
Pigment colours	36,00	36,00	29,00	29,00	29,00	39,00
Socks	15,00	15,00	15,00	15,00	15,00	15,00
Foam BS 5852 Crib 5	6,00			5,00		
Decorative nails	30,00			29,00		
Reinforcement mesh		28,00			28,00	
Footrest plate						
Connection into rows						
Engraving						
<b>TECHNICAL INFORMATION</b>						<b>high/low</b>
Total width (cm)	51,5	51,5	41	41	41	40,5/40,5
Total depth (cm)	59	59	51,5	51,5	51,5	50/50
Total height (cm)	87	87	84	84	84	110/95
Armrest height (cm)	64	66				
Seat height (cm)	46	46	46	46	46	76/61
Width of seat (cm)	42,5	42,5	∅ 40,5	∅ 40,5	∅ 40,5	∅ 40,5/∅ 40,5
Depth of seat (cm)	45,5	45,5	∅ 40,5	∅ 40,5	∅ 40,5	∅ 40,5/∅ 40,5
Weight of product (kg)	4,5	4,2	3,3	3,6	3,3	4,2/3,9
Consumption of fabric (m)	0,289			0,182		
Consumption of leather (m²)	0,660			0,528		
Packing (pcs)	1	1	2	2	2	1
Volume (m³/pc)	0,345	0,345	0,153	0,153	0,153	0,309/0,262
Carton dimensions (cm)	61 × 54 × 91	61 × 54 × 91	59 × 45 × 100	59 × 45 × 100	59 × 45 × 100	52 × 44 × 117/ 52 × 44 × 99
Bicolour						
Stackability						
Embossed seat/backrest			202, 206, 219, 259			202, 206, 219, 259

2

14

TON R&amp;D

18

TON R&amp;D



PRODUCT NUMBER	313 134	315 134	311 018	313 018	315 018	311 132
Type	barstool	barstool	chair	chair	chair	barstool
Seat option	upholstery	cane/mesh Polo	veneer	upholstery	cane/mesh Polo	veneer
Back option						
Type of wood	beech	beech	beech	beech	beech	beech
<b>PRICES IN € (VAT NOT INCLUDED)</b>						
Veneer seat			304,00			364,00
Upholstery - category A	381,00			325,00		
Upholstery - category B	385,00			329,00		
Upholstery - category C	388,00			332,00		
Upholstery - category D	395,00			339,00		
Upholstery - category E	413,00			357,00		
Upholstery - category 1	414,00			358,00		
Upholstery - category 2	457,00			401,00		
Upholstery - COM	377,00			321,00		
Cane		421,00			365,00	
Mesh Polo		449,00			393,00	
<b>SURCHARGES IN € (VAT NOT INCLUDED)</b>						
Antique colour	23,00	23,00	19,00	19,00	19,00	23,00
Pigment colours	39,00	39,00	29,00	29,00	29,00	39,00
Socks	15,00	15,00	15,00	15,00	15,00	15,00
Foam BS 5852 Crib 5	5,00			5,00		
Decorative nails	29,00			29,00		
Reinforcement mesh		28,00			28,00	
Footrest plate						
Connection into rows						
Engraving						
<b>TECHNICAL INFORMATION</b>	<b>high/low</b>	<b>high/low</b>				<b>high/low</b>
Total width (cm)	40,5/40,5	40,5/40,5	41	41	41	40,5/40,5
Total depth (cm)	50/50	50/50	51,5	51,5	51,5	50/50
Total height (cm)	110/95	110/95	84	84	84	110/95
Armrest height (cm)						
Seat height (cm)	78/63	76/61	46	46	46	76/61
Width of seat (cm)	ø 40,5/ø 40,5	ø 40,5/ø 40,5	ø 40,5	ø 40,5	ø 40,5	ø 40,5/ø 40,5
Depth of seat (cm)	ø 40,5/ø 40,5	ø 40,5/ø 40,5	ø 40,5	ø 40,5	ø 40,5	ø 40,5/ø 40,5
Weight of product (kg)	4,6/4,3	4,2/3,9	3,3	3,6	3,3	4,2/3,9
Consumption of fabric (m)	0,182			0,182		
Consumption of leather (m <sup>2</sup> )	0,528			0,528		
Packing (pcs)	1	1	2	2	2	1
Volume (m <sup>3</sup> /pc)	0,309/0,262	0,309/0,262	0,153	0,153	0,153	0,309/0,262
Carton dimensions (cm)	52 × 44 × 117/ 52 × 44 × 99	52 × 44 × 117/ 52 × 44 × 99	59 × 45 × 100	59 × 45 × 100	59 × 45 × 100	52 × 44 × 117/ 52 × 44 × 99
Bicolour						
Stackability						
Embossed seat/backrest			202, 206, 219, 259			202, 206, 219, 259

18

TON R&amp;D

20

TON R&amp;D



PRODUCT NUMBER	313 132	315 132	313 020	315 020	316 020	317 020
Type	barstool	barstool	chair	chair	chair	chair
Seat option	upholstery	cane/mesh Polo	upholstery	cane/mesh Polo	veneer	upholstery
Back option			upholstery	cane/mesh Polo	cane/mesh Polo	cane/mesh Polo
Type of wood	beech	beech	beech	beech	beech	beech
<b>PRICES IN € (VAT NOT INCLUDED)</b>						
Veneer seat					401,00	
Upholstery - category A	385,00		429,00			417,00
Upholstery - category B	389,00		439,00			421,00
Upholstery - category C	392,00		447,00			424,00
Upholstery - category D	399,00		465,00			432,00
Upholstery - category E	417,00		510,00			450,00
Upholstery - category 1	418,00		496,00			451,00
Upholstery - category 2	461,00		584,00			493,00
Upholstery - COM	381,00		421,00			414,00
Cane		425,00		470,00		
Mesh Polo		453,00		498,00		
<b>SURCHARGES IN € (VAT NOT INCLUDED)</b>						
Antique colour	23,00	23,00	18,00	18,00	18,00	18,00
Pigment colours	39,00	39,00	27,00	27,00	27,00	27,00
Socks	15,00	15,00	15,00	15,00	15,00	15,00
Foam BS 5852 Crib 5	5,00		9,00			5,00
Decorative nails	29,00					29,00
Reinforcement mesh		28,00		28,00		
Footrest plate						
Connection into rows						
Engraving						
<b>TECHNICAL INFORMATION</b>						
	high/low	high/low				
Total width (cm)	40,5/40,5	40,5/40,5	41	41	41	41
Total depth (cm)	50/50	50/50	54	54	54	54
Total height (cm)	110/95	110/95	84	84	84	84
Armrest height (cm)						
Seat height (cm)	78/63	76/61	46	46	46	46
Width of seat (cm)	ø 40,5/ø 40,5	ø 40,5/ø 40,5	39,5	39,5	39,5	39,5
Depth of seat (cm)	ø 40,5/ø 40,5	ø 40,5/ø 40,5	40,5	40,5	40,5	40,5
Weight of product (kg)	4,6/4,3	4,2/3,9	3,7	3,3	3,5	3,7
Consumption of fabric (m)	0,182		0,447			0,182
Consumption of leather (m²)	0,528		1,089			0,528
Packing (pcs)	1	1	2	2	2	2
Volume (m³/pc)	0,309/0,262	0,309/0,262	0,168	0,168	0,168	0,168
Carton dimensions (cm)	52 × 44 × 117/ 52 × 44 × 99	52 × 44 × 117/ 52 × 44 × 99	64 × 45 × 101	64 × 45 × 101	64 × 45 × 101	64 × 45 × 101
Bicolour						
Stackability						
Embossed seat/backrest					203, 209, 223, 255, 256	

2



20

TON R&amp;D

24

TON R&amp;D



PRODUCT NUMBER	323 020	325 020	326 020	327 020	321 024	323 024
Type	armchair	armchair	armchair	armchair	armchair	armchair
Seat option	upholstery	cane/mesh Polo	veneer	upholstery	veneer	upholstery
Back option	upholstery	cane/mesh Polo	cane/mesh Polo	cane/mesh Polo		
Type of wood	beech	beech	beech	beech	beech	beech
<b>PRICES IN € (VAT NOT INCLUDED)</b>						
Veneer seat			533,00		365,00	
Upholstery - category A	551,00			552,00		381,00
Upholstery - category B	562,00			558,00		385,00
Upholstery - category C	571,00			563,00		388,00
Upholstery - category D	591,00			575,00		396,00
Upholstery - category E	641,00			604,00		414,00
Upholstery - category 1	616,00			591,00		415,00
Upholstery - category 2	704,00			644,00		457,00
Upholstery - COM	542,00			546,00		378,00
Cane		602,00				
Mesh Polo		630,00				
<b>SURCHARGES IN € (VAT NOT INCLUDED)</b>						
Antique colour	20,00	20,00	20,00	20,00	24,00	24,00
Pigment colours	29,00	29,00	29,00	29,00	44,00	44,00
Socks	15,00	15,00	15,00	15,00	15,00	15,00
Foam BS 5852 Crib 5	10,00			6,00		5,00
Decorative nails				30,00		34,00
Reinforcement mesh		28,00				
Footrest plate						
Connection into rows						
Engraving					14,00	14,00
<b>TECHNICAL INFORMATION</b>						
Total width (cm)	54	54	54	54	54	54
Total depth (cm)	59	59	59	59	49,3	49,3
Total height (cm)	84	84	84	84	77	75
Armrest height (cm)	68	70	70	68	71,5	69,5
Seat height (cm)	46	46	46	46	46	46
Width of seat (cm)	42,5	42,5	42,5	42,5	39,5	39,5
Depth of seat (cm)	45,5	45,5	45,5	45,5	40,5	40,5
Weight of product (kg)	4,4	4	4,2	4,4	5,3	5,4
Consumption of fabric (m)	0,497			0,289		0,182
Consumption of leather (m <sup>2</sup> )	1,089			0,660		0,528
Packing (pcs)	1	1	1	1	2	2
Volume (m <sup>3</sup> /pc)	0,345	0,345	0,345	0,345	0,209	0,209
Carton dimensions (cm)	61 × 54 × 91	61 × 54 × 91	61 × 54 × 91	61 × 54 × 91	61 × 57 × 104	61 × 57 × 104
Bicolour						
Stackability						
Embossed seat/backrest			203, 209, 223, 255, 256		203, 209, 223, 255, 256	

24

TON R&amp;D

25

TON R&amp;D

30

TON R&amp;D



PRODUCT NUMBER	325 024	321 025	323 025	325 025	321 030	323 030
Type	armchair	armchair	armchair	armchair	armchair	armchair
Seat option	cane/mesh Polo	veneer	upholstery	cane/mesh Polo	veneer	upholstery
Back option						
Type of wood	beech	beech	beech	beech	beech	beech
<b>PRICES IN € (VAT NOT INCLUDED)</b>						
Veneer seat		373,00			387,00	
Upholstery - category A			392,00			405,00
Upholstery - category B			398,00			412,00
Upholstery - category C			403,00			418,00
Upholstery - category D			415,00			430,00
Upholstery - category E			444,00			462,00
Upholstery - category 1			431,00			452,00
Upholstery - category 2			484,00			514,00
Upholstery - COM			386,00			399,00
Cane	438,00			445,00		
Mesh Polo	466,00			473,00		
<b>SURCHARGES IN € (VAT NOT INCLUDED)</b>						
Antique colour	24,00	24,00	24,00	24,00	22,00	22,00
Pigment colours	44,00	44,00	44,00	44,00	35,00	35,00
Socks	15,00	15,00	15,00	15,00	15,00	15,00
Foam BS 5852 Crib 5			6,00			7,00
Decorative nails			35,00			34,00
Reinforcement mesh	28,00			28,00		
Footrest plate						
Connection into rows						
Engraving	14,00	14,00	14,00	14,00		
<b>TECHNICAL INFORMATION</b>						
Total width (cm)	54	57	57	57	54,5	54,5
Total depth (cm)	49,3	55	55	55	57	57
Total height (cm)	77	80	78	80	78	76
Armrest height (cm)	71,5	71,5	69,5	71,5	70	68
Seat height (cm)	46	46	46	46	46	46
Width of seat (cm)	39,5	42,5	42,5	42,5	∅ 48	∅ 48
Depth of seat (cm)	40,5	45,5	45,5	45,5	∅ 48	∅ 48
Weight of product (kg)	5,3	6	6,2	6	4,1	4,7
Consumption of fabric (m)			0,289			0,318
Consumption of leather (m²)			0,660			0,770
Packing (pcs)	2	2	2	2	1	1
Volume (m³/pc)	0,209	0,233	0,233	0,233	0,331	0,331
Carton dimensions (cm)	61 × 57 × 104	66 × 59 × 104	66 × 59 × 104	66 × 59 × 104	60 × 57 × 84	60 × 57 × 84
Bicolour						
Stackability						
Embossed seat/backrest		203, 209, 223, 255, 256			202, 206, 259	

2

**30**  
TON R&D

**33**  
TON R&D

**56**  
TON R&D



PRODUCT NUMBER	325 030	323 033	325 033	326 033	327 033	311 056
Type	armchair	armchair	armchair	armchair	armchair	chair
Seat option	cane/mesh Polo	upholstery	cane/mesh Polo	veneer	upholstery	veneer
Back option		upholstery	cane/mesh Polo	cane/mesh Polo	cane/mesh Polo	
Type of wood	beech	beech	beech	beech	beech	beech
<b>PRICES IN € (VAT NOT INCLUDED)</b>						
Veneer seat				513,00		271,00
Upholstery - category A		550,00			531,00	
Upholstery - category B		569,00			538,00	
Upholstery - category C		584,00			544,00	
Upholstery - category D		618,00			556,00	
Upholstery - category E		702,00			588,00	
Upholstery - category 1		636,00			578,00	
Upholstery - category 2		759,00			640,00	
Upholstery - COM		534,00			525,00	
Cane	470,00		596,00			
Mesh Polo	498,00		624,00			
<b>SURCHARGES IN € (VAT NOT INCLUDED)</b>						
Antique colour	22,00	21,00	21,00	21,00	21,00	20,00
Pigment colours	35,00	34,00	34,00	34,00	34,00	38,00
Socks	15,00	15,00	15,00	15,00	15,00	15,00
Foam BS 5852 Crib 5		10,00			7,00	
Decorative nails					34,00	
Reinforcement mesh	28,00		28,00			
Footrest plate						
Connection into rows						
Engraving						14,00
<b>TECHNICAL INFORMATION</b>						
Total width (cm)	54,5	54,5	54,5	54,5	54,5	44,5
Total depth (cm)	57	57	57	57	57	48
Total height (cm)	78	76	78	78	76	80
Armrest height (cm)	70	68	70	70	68	
Seat height (cm)	46	46	46	46	46	46
Width of seat (cm)	∅ 48	∅ 48	∅ 48	∅ 48	∅ 48	39,5
Depth of seat (cm)	∅ 48	∅ 48	∅ 48	∅ 48	∅ 48	40,5
Weight of product (kg)	4,1	4,9	4	4,2	4,4	3,4
Consumption of fabric (m)		0,844			0,318	
Consumption of leather (m <sup>2</sup> )		1,529			0,770	
Packing (pcs)	1	1	1	1	1	2
Volume (m <sup>3</sup> /pc)	0,331	0,331	0,331	0,331	0,331	0,161
Carton dimensions (cm)	60 × 57 × 84	60 × 57 × 84	60 × 57 × 84	60 × 57 × 84	60 × 57 × 84	59 × 47 × 101
Bicolour						
Stackability						
Embossed seat/backrest				202, 206, 259		203, 209, 223, 255, 256

56

TON R&amp;D

60

TON R&amp;D

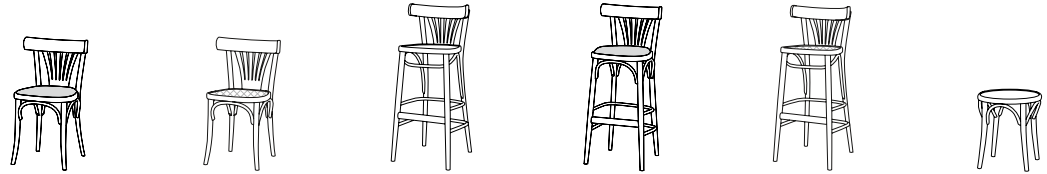

PRODUCT NUMBER	313 056	315 056	311 130	313 130	315 130	371 060
Type	chair	chair	barstool	barstool	barstool	stool
Seat option	upholstery	cane/mesh Polo	veneer	upholstery	cane/mesh Polo	veneer
Back option						
Type of wood	beech	beech	beech	beech	beech	beech
<b>PRICES IN € (VAT NOT INCLUDED)</b>						
Veneer seat			351,00			199,00
Upholstery - category A	287,00			367,00		
Upholstery - category B	291,00			371,00		
Upholstery - category C	294,00			374,00		
Upholstery - category D	302,00			382,00		
Upholstery - category E	320,00			400,00		
Upholstery - category 1	321,00			401,00		
Upholstery - category 2	363,00			443,00		
Upholstery - COM	284,00			364,00		
Cane		344,00			424,00	
Mesh Polo		372,00			539,00	
<b>SURCHARGES IN € (VAT NOT INCLUDED)</b>						
Antique colour	20,00	20,00	24,00	24,00	24,00	19,00
Pigment colours	38,00	38,00	49,00	49,00	49,00	25,00
Socks	15,00	15,00	15,00	15,00	15,00	15,00
Foam BS 5852 Crib 5	5,00			5,00		
Decorative nails	29,00			29,00		
Reinforcement mesh		28,00			28,00	
Footrest plate			19,00	19,00	19,00	
Connection into rows						
Engraving	14,00	14,00	14,00	14,00	14,00	
<b>TECHNICAL INFORMATION</b>			<b>high/low</b>	<b>high/low</b>	<b>high/low</b>	
Total width (cm)	44,5	44,5	44,5/44,5	44,5/44,5	44,5/44,5	44,5
Total depth (cm)	48	48	47/47	47/47	47/47	44,5
Total height (cm)	80	80	104/89	102/87	104/89	46
Armrest height (cm)						
Seat height (cm)	46	46	76/61	76/61	76/61	46
Width of seat (cm)	39,5	39,5	39,5/39,5	39,5/39,5	39,5/39,5	ø 40,5
Depth of seat (cm)	40,5	40,5	40,5/40,5	40,5/40,5	40,5/40,5	ø 40,5
Weight of product (kg)	4	3,4	5/4,7	5,4/5,1	5/4,7	2,5
Consumption of fabric (m)	0,182			0,182		
Consumption of leather (m²)	0,528			0,528		
Packing (pcs)	2	2	1	1	1	1
Volume (m³/pc)	0,161	0,161	0,328/0,274	0,328/0,274	0,328/0,274	0,113
Carton dimensions (cm)	59 × 47 × 101	59 × 47 × 101	52 × 48 × 114/ 50 × 48 × 99	52 × 48 × 114/ 50 × 48 × 99	52 × 48 × 114/ 50 × 48 × 99	43 × 43 × 53
Bicolour						
Stackability						
Embossed seat/backrest			203, 209, 223, 255, 256			202, 206, 219, 259

2

**60**  
TON R&D

**73**  
TON R&D

**135**  
TON R&D



PRODUCT NUMBER	373 060	375 060	371 073	373 073	375 073	321 135
Type	stool	stool	barstool	barstool	barstool	barstool
Seat option	upholstery	cane/mesh Polo	veneer	upholstery	cane/mesh Polo	veneer
Back option						
Type of wood	beech	beech	beech	beech	beech	beech
<b>PRICES IN € (VAT NOT INCLUDED)</b>						
Veneer seat			281,00			428,00
Upholstery - category A	220,00			294,00		
Upholstery - category B	224,00			298,00		
Upholstery - category C	227,00			301,00		
Upholstery - category D	234,00			308,00		
Upholstery - category E	252,00			326,00		
Upholstery - category 1	253,00			328,00		
Upholstery - category 2	296,00			371,00		
Upholstery - COM	216,00			291,00		
Cane		260,00			319,00	
Mesh Polo		288,00			347,00	
<b>SURCHARGES IN € (VAT NOT INCLUDED)</b>						
Antique colour	19,00	19,00	19,00	19,00	19,00	26,00
Pigment colours	25,00	25,00	35,00	35,00	35,00	55,00
Socks	15,00	15,00				15,00
Foam BS 5852 Crib 5	5,00			5,00		
Decorative nails	29,00			29,00		
Reinforcement mesh		28,00			28,00	
Footrest plate						19,00
Connection into rows						
Engraving						14,00
<b>TECHNICAL INFORMATION</b>						<b>high/low</b>
Total width (cm)	44,5	44,5	47	47	47	54/54
Total depth (cm)	44,5	44,5	47	47	47	49/49
Total height (cm)	46	46	78	78	78	107/92
Armrest height (cm)						102,5/87,5
Seat height (cm)	46	46	78	78	78	76/61
Width of seat (cm)	ø 40,5	ø 40,5	ø 37	ø 37	ø 37	39,5/39,5
Depth of seat (cm)	ø 40,5	ø 40,5	ø 37	ø 37	ø 37	40,5/40,5
Weight of product (kg)	2,7	2,5	3,8	4,3	3,8	5,6/5,3
Consumption of fabric (m)	0,182			0,174		
Consumption of leather (m²)	0,528			0,528		
Packing (pcs)	1	1	1	1	1	1
Volume (m³/pc)	0,113	0,113	0,159	0,159	0,159	0,375/0,319
Carton dimensions (cm)	43 × 43 × 53	43 × 43 × 53	40 × 40 × 86	40 × 40 × 86	40 × 40 × 86	56 × 51 × 114/ 56 × 51 × 97
Bicolour						
Stackability						
Embossed seat/backrest			202, 206, 219, 259			203, 209, 223, 255, 256

135

TON R&amp;D

150

TON R&amp;D



PRODUCT NUMBER	323 135	325 135	311 149	313 149	315 149	311 150
Type	barstool	barstool	barstool	barstool	barstool	chair
Seat option	upholstery	cane/mesh Polo	veneer	upholstery	cane/mesh Polo	veneer
Back option						
Type of wood	beech	beech	beech	beech	beech	beech
<b>PRICES IN € (VAT NOT INCLUDED)</b>						
Veneer seat			<b>384,00</b>			<b>318,00</b>
Upholstery - category A	<b>444,00</b>			<b>400,00</b>		
Upholstery - category B	<b>448,00</b>			<b>404,00</b>		
Upholstery - category C	<b>451,00</b>			<b>407,00</b>		
Upholstery - category D	<b>459,00</b>			<b>415,00</b>		
Upholstery - category E	<b>477,00</b>			<b>433,00</b>		
Upholstery - category 1	<b>478,00</b>			<b>434,00</b>		
Upholstery - category 2	<b>520,00</b>			<b>476,00</b>		
Upholstery - COM	<b>441,00</b>			<b>397,00</b>		
Cane		<b>501,00</b>			<b>457,00</b>	
Mesh Polo		<b>529,00</b>			<b>485,00</b>	
<b>SURCHARGES IN € (VAT NOT INCLUDED)</b>						
Antique colour	<b>26,00</b>	<b>26,00</b>	<b>23,00</b>	<b>23,00</b>	<b>23,00</b>	<b>19,00</b>
Pigment colours	<b>55,00</b>	<b>55,00</b>	<b>42,00</b>	<b>42,00</b>	<b>42,00</b>	<b>34,00</b>
Socks	<b>15,00</b>	<b>15,00</b>	<b>15,00</b>	<b>15,00</b>	<b>15,00</b>	<b>15,00</b>
Foam BS 5852 Crib 5	<b>5,00</b>			<b>5,00</b>		
Decorative nails	<b>34,00</b>			<b>29,00</b>		
Reinforcement mesh		<b>28,00</b>			<b>28,00</b>	
Footrest plate	<b>19,00</b>	<b>19,00</b>				
Connection into rows						
Engraving	<b>14,00</b>	<b>14,00</b>				
<b>TECHNICAL INFORMATION</b>	<b>high/low</b>	<b>high/low</b>	<b>high/low</b>	<b>high/low</b>	<b>high/low</b>	
Total width (cm)	54/54	54/54	45/45	45/45	45/45	45
Total depth (cm)	49/49	49/49	47,5/46	47,5/46	47,5/46	51
Total height (cm)	105/90	107/92	109,5/94,5	107,5/92,5	109,5/94,5	86,5
Armrest height (cm)	100,5/85,5	102,5/87,5				
Seat height (cm)	76/61	76/61	76/61	76/61	76/61	46
Width of seat (cm)	39,5/39,5	39,5/39,5	39,5/39,5	39,5/39,5	39,5/39,5	39,5
Depth of seat (cm)	40,5/40,5	40,5/40,5	40,5/40,5	40,5/40,5	40,5/40,5	40,5
Weight of product (kg)	6,1/5,8	5,6/5,3	4,6/4,3	4,8/4,5	4,6/4,3	3,7
Consumption of fabric (m)	0,182			0,182		
Consumption of leather (m <sup>2</sup> )	0,528			0,528		
Packing (pcs)	1	1	1	1	1	2
Volume (m <sup>3</sup> /pc)	0,375/0,319	0,375/0,319	0,328/0,274	0,328/0,274	0,328/0,274	0,183
Carton dimensions (cm)	56 × 51 × 114/ 56 × 51 × 97	56 × 51 × 114/ 56 × 51 × 97	52 × 48 × 114/ 50 × 48 × 99	52 × 48 × 114/ 50 × 48 × 99	52 × 48 × 114/ 50 × 48 × 99	62 × 48 × 107
Bicolour						
Stackability						
Embossed seat/backrest			203, 209, 223, 255, 256			203, 209, 223, 255, 256

2

**150**  
TON R&D

**763**  
TON R&D

**811**  
TON R&D



PRODUCT NUMBER	313 150	315 150	311 763	313 763	315 763	313 811
Type	chair	chair	chair	chair	chair	chair
Seat option	upholstery	cane/mesh Polo	veneer	upholstery	cane/mesh Polo	upholstery
Back option						upholstery
Type of wood	beech	beech	beech	beech	beech	beech
<b>PRICES IN € (VAT NOT INCLUDED)</b>						
Veneer seat			289,00			
Upholstery - category A	334,00			305,00		420,00
Upholstery - category B	338,00			309,00		437,00
Upholstery - category C	341,00			312,00		450,00
Upholstery - category D	349,00			320,00		479,00
Upholstery - category E	367,00			338,00		554,00
Upholstery - category 1	368,00			339,00		510,00
Upholstery - category 2	410,00			381,00		633,00
Upholstery - COM	331,00			302,00		406,00
Cane		391,00			362,00	
Mesh Polo		419,00			390,00	
<b>SURCHARGES IN € (VAT NOT INCLUDED)</b>						
Antique colour	19,00	19,00	19,00	19,00	19,00	18,00
Pigment colours	34,00	34,00	35,00	35,00	35,00	25,00
Socks	15,00	15,00	15,00	15,00	15,00	15,00
Foam BS 5852 Crib 5	5,00			5,00		15,00
Decorative nails	29,00			29,00		
Reinforcement mesh		28,00			28,00	
Footrest plate						
Connection into rows						
Engraving			14,00	14,00	14,00	
<b>TECHNICAL INFORMATION</b>						
Total width (cm)	45	45	45,5	45,5	45,5	45
Total depth (cm)	51	51	47,5	47,5	47,5	53,5
Total height (cm)	84,5	86,5	78	78	78	80
Armrest height (cm)						
Seat height (cm)	46	46	46	46	46	46
Width of seat (cm)	39,5	39,5	39,5	39,5	39,5	45
Depth of seat (cm)	40,5	40,5	40,5	40,5	40,5	41
Weight of product (kg)	3,9	3,7	3,6	4,4	3,6	4,7
Consumption of fabric (m)	0,182			0,182		0,739
Consumption of leather (m²)	0,528			0,528		1,529
Packing (pcs)	2	2	2	2	2	2
Volume (m³/pc)	0,183	0,183	0,161	0,161	0,161	0,198
Carton dimensions (cm)	62 × 48 × 107	62 × 48 × 107	59 × 47 × 101	59 × 47 × 101	59 × 47 × 101	70 × 49 × 100
Bicolour						
Stackability						
Embossed seat/backrest			203, 209, 223, 255, 256			



PRODUCT NUMBER	315 811	316 811	317 811	323 811	325 811	326 811
Type	chair	chair	chair	armchair	armchair	armchair
Seat option	cane/mesh Polo	veneer	upholstery	upholstery	cane/mesh Polo	veneer
Back option	cane/mesh Polo	cane/mesh Polo	cane/mesh Polo	upholstery	cane/mesh Polo	cane/mesh Polo
Type of wood	beech	beech	beech	beech	beech	beech
<b>PRICES IN € (VAT NOT INCLUDED)</b>						
Veneer seat		398,00				513,00
Upholstery - category A			404,00	535,00		
Upholstery - category B			410,00	552,00		
Upholstery - category C			415,00	565,00		
Upholstery - category D			427,00	594,00		
Upholstery - category E			455,00	669,00		
Upholstery - category 1			461,00	625,00		
Upholstery - category 2			532,00	748,00		
Upholstery - COM			399,00	521,00		
Cane	451,00				566,00	
Mesh Polo	479,00				594,00	
<b>SURCHARGES IN € (VAT NOT INCLUDED)</b>						
Antique colour	18,00	18,00	18,00	22,00	22,00	22,00
Pigment colours	25,00	25,00	25,00	30,00	30,00	30,00
Socks	15,00	15,00	15,00	15,00	15,00	15,00
Foam BS 5852 Crib 5			6,00	15,00		
Decorative nails						
Reinforcement mesh	28,00				28,00	
Footrest plate						
Connection into rows						
Engraving						
<b>TECHNICAL INFORMATION</b>						
Total width (cm)	45	45	45	50	50	50
Total depth (cm)	53,5	53,5	53,5	53,5	53,5	53,5
Total height (cm)	80	80	80	80	80	80
Armrest height (cm)				68	70	70
Seat height (cm)	46	46	46	46	46	46
Width of seat (cm)	45	45	45	45	45	45
Depth of seat (cm)	41	41	41	41	41	41
Weight of product (kg)	3,6	3,8	4,3	5,4	4,3	4,5
Consumption of fabric (m)			0,284	0,739		
Consumption of leather (m²)			0,880	1,529		
Packing (pcs)	2	2	2	1	1	1
Volume (m³/pc)	0,198	0,198	0,198	0,293	0,293	0,293
Carton dimensions (cm)	70 × 49 × 100	70 × 49 × 100	70 × 49 × 100	55 × 55 × 84	55 × 55 × 84	55 × 55 × 84
Bicolour						
Stackability						
Embossed seat/backrest						



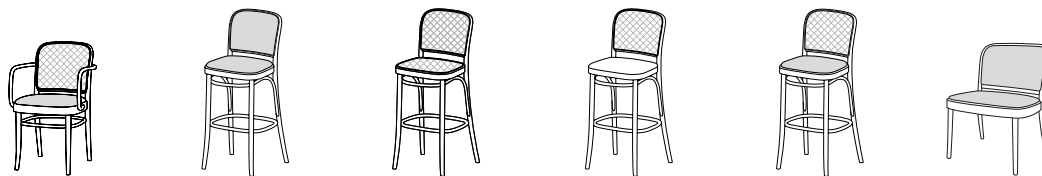

PRODUCT NUMBER	327 811	313 813	315 813	316 813	317 813	363 816
Type	armchair	barstool	barstool	barstool	barstool	lounge chair
Seat option	upholstery	upholstery	cane/mesh Polo	veneer	upholstery	upholstery
Back option	cane/mesh Polo	upholstery	cane/mesh Polo	cane/mesh Polo	cane/mesh Polo	upholstery
Type of wood	beech	beech	beech	beech	beech	beech
<b>PRICES IN € (VAT NOT INCLUDED)</b>						
Veneer seat				478,00		
Upholstery - category A	519,00	500,00			484,00	550,00
Upholstery - category B	525,00	517,00			490,00	569,00
Upholstery - category C	530,00	530,00			495,00	584,00
Upholstery - category D	542,00	559,00			507,00	617,00
Upholstery - category E	570,00	634,00			535,00	701,00
Upholstery - category 1	576,00	590,00			541,00	680,00
Upholstery - category 2	647,00	713,00			612,00	848,00
Upholstery - COM	514,00	486,00			479,00	535,00
Cane			531,00			
Mesh Polo			559,00			
<b>SURCHARGES IN € (VAT NOT INCLUDED)</b>						
Antique colour	22,00	25,00	25,00	25,00	25,00	27,00
Pigment colours	30,00	35,00	35,00	35,00	35,00	35,00
Socks	15,00	15,00	15,00	15,00	15,00	15,00
Foam BS 5852 Crib 5	6,00	15,00			6,00	18,00
Decorative nails						
Reinforcement mesh			28,00			
Footrest plate						
Connection into rows						
Engraving						
<b>TECHNICAL INFORMATION</b>						
		high/low	high/low	high/low	high/low	
Total width (cm)	50	48/46	48/46	48/46	48/46	58,4
Total depth (cm)	53,5	53/53	53/53	53/53	53/53	61,5
Total height (cm)	80	109/92	109/92	109/92	109/92	75
Armrest height (cm)	68					
Seat height (cm)	46	78/61	78/61	78/61	78/61	45
Width of seat (cm)	45	45/45	45/45	45/45	45/45	58,4
Depth of seat (cm)	41	41/41	41/41	41/41	41/41	46,3
Weight of product (kg)	5	5,7/5,4	4,6/4,3	4,8/4,5	5,3/5	5,1
Consumption of fabric (m)	0,284	0,739			0,284	0,837
Consumption of leather (m <sup>2</sup> )	0,880	1,529			0,880	2,090
Packing (pcs)	1	1	1	1	1	1
Volume (m <sup>3</sup> /pc)	0,293	0,375/0,319	0,375/0,319	0,375/0,319	0,375/0,319	0,391
Carton dimensions (cm)	55 × 55 × 84	56 × 51 × 114/ 56 × 51 × 97	56 × 51 × 114/ 56 × 51 × 97	56 × 51 × 114/ 56 × 51 × 97	56 × 51 × 114/ 56 × 51 × 97	66 × 62 × 83
Bicolour						
Stackability						
Embossed seat/backrest						

811

Claesson Koivisto Rune

822

Claesson Koivisto Rune



PRODUCT NUMBER	365 816	367 816	363 817	365 817	367 817	311 822
Type	lounge chair	lounge chair	lounge armchair	lounge armchair	lounge armchair	chair
Seat option	cane	upholstery	upholstery	cane	upholstery	veneer
Back option	cane	cane	upholstery	cane	cane	veneer
Type of wood	beech	beech	beech	beech	beech	beech
<b>PRICES IN € (VAT NOT INCLUDED)</b>						
Veneer seat						430,00
Upholstery - category A		589,00	675,00		714,00	
Upholstery - category B		596,00	694,00		721,00	
Upholstery - category C		602,00	709,00		727,00	
Upholstery - category D		615,00	742,00		740,00	
Upholstery - category E		647,00	826,00		772,00	
Upholstery - category 1		651,00	805,00		776,00	
Upholstery - category 2		729,00	973,00		854,00	
Upholstery - COM		583,00	660,00		708,00	
Cane	582,00			707,00		
Mesh Polo						
<b>SURCHARGES IN € (VAT NOT INCLUDED)</b>						
Antique colour	27,00	27,00	31,00	31,00	31,00	23,00
Pigment colours	35,00	35,00	40,00	40,00	40,00	35,00
Socks	15,00	15,00	15,00	15,00	15,00	
Foam BS 5852 Crib 5		8,00	18,00		8,00	
Decorative nails						
Reinforcement mesh	*			*		
Footrest plate						
Connection into rows						
Engraving						
<b>TECHNICAL INFORMATION</b>						
Total width (cm)	58,4	58,4	65,2	65,2	65,2	45
Total depth (cm)	61,5	61,5	61,5	61,5	61,5	52,4
Total height (cm)	75	75	75	75	75	80,2
Armrest height (cm)			59,5	59,5	59,5	
Seat height (cm)	42	45	45	42	45	46
Width of seat (cm)	58,4	58,4	58,4	58,4	58,4	45
Depth of seat (cm)	46,3	46,3	46,3	46,3	46,3	41
Weight of product (kg)	3,8	4,9	5,6	4,3	5,4	4
Consumption of fabric (m)		0,318	0,837		0,318	
Consumption of leather (m <sup>2</sup> )		0,961	2,090		0,961	
Packing (pcs)	1	1	1	1	1	2
Volume (m <sup>3</sup> /pc)	0,391	0,391	0,391	0,391	0,391	0,198
Carton dimensions (cm)	66 × 62 × 83	66 × 62 × 83	66 × 62 × 83	66 × 62 × 83	66 × 62 × 83	70 × 49 × 100
Bicolour						
Stackability						
Embossed seat/backrest						

\* The price is already inclusive of the surcharge.

2



PRODUCT NUMBER	313 822	321 822	323 822	371 824	373 824	371 825
Type	chair	armchair	armchair	barstool	barstool	stool
Seat option	upholstery	veneer	upholstery	veneer	upholstery	veneer
Back option	veneer	veneer	veneer			
Type of wood	beech	beech	beech	beech	beech	beech
<b>PRICES IN € (VAT NOT INCLUDED)</b>						
Veneer seat		565,00		292,00		214,00
Upholstery - category A	424,00		559,00		306,00	
Upholstery - category B	431,00		566,00		310,00	
Upholstery - category C	436,00		571,00		314,00	
Upholstery - category D	448,00		583,00		321,00	
Upholstery - category E	477,00		612,00		338,00	
Upholstery - category 1	476,00		611,00		355,00	
Upholstery - category 2	542,00		677,00		412,00	
Upholstery - COM	419,00		554,00		303,00	
Cane						
Mesh Polo						
<b>SURCHARGES IN € (VAT NOT INCLUDED)</b>						
Antique colour	23,00	27,00	27,00	19,00	19,00	16,00
Pigment colours	35,00	40,00	40,00	25,00	25,00	21,00
Socks						
Foam BS 5852 Crib 5	6,00		6,00		5,00	
Decorative nails					29,00	
Reinforcement mesh						
Footrest plate						
Connection into rows						
Engraving						
<b>TECHNICAL INFORMATION</b>						
				high/low	high/low	
Total width (cm)	45	50	50	46/42,6	46/42,6	38,8
Total depth (cm)	52,4	52,4	52,4	46/42,6	46/42,6	38,8
Total height (cm)	78,2	80,2	78,2	78/61	80/63	46
Armrest height (cm)		64,7	62,7			
Seat height (cm)	47	46	47	78/61	80/63	46
Width of seat (cm)	45	45	45	∅ 37	∅ 37	∅ 37
Depth of seat (cm)	41	41	41	∅ 37	∅ 37	∅ 37
Weight of product (kg)	4,3	4,6	4,9	3,6/3,3	3,8/3,5	2,5
Consumption of fabric (m)	0,289		0,289		0,177	
Consumption of leather (m <sup>2</sup> )	0,816		0,816		0,715	
Packing (pcs)	2	1	1	1	1	1
Volume (m <sup>3</sup> /pc)	0,198	0,293	0,293	0,159	0,159	0,113
Carton dimensions (cm)	70 × 49 × 100	55 × 55 × 84	55 × 55 × 84	40 × 40 × 86	40 × 40 × 86	43 × 43 × 53
Bicolour						
Stackability						
Embossed seat/backrest						

822

Claesson Koivisto Rune

again →

Alexander Gufler

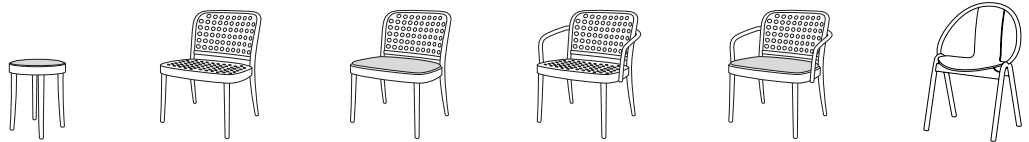

PRODUCT NUMBER	373 825	361 826	363 826	361 827	363 827	311 005
Type	stool	lounge chair	lounge chair	lounge armchair	lounge armchair	chair
Seat option	upholstery	veneer	upholstery	veneer	upholstery	veneer
Back option		veneer	veneer	veneer	veneer	veneer
Type of wood	beech	beech	beech	beech	beech	beech
<b>PRICES IN € (VAT NOT INCLUDED)</b>						
Veneer seat		538,00		663,00		470,00
Upholstery - category A	228,00		525,00		650,00	
Upholstery - category B	232,00		532,00		657,00	
Upholstery - category C	236,00		538,00		663,00	
Upholstery - category D	243,00		551,00		676,00	
Upholstery - category E	260,00		583,00		708,00	
Upholstery - category 1	277,00		587,00		712,00	
Upholstery - category 2	334,00		665,00		790,00	
Upholstery - COM	225,00		519,00		644,00	
Cane						
Mesh Polo						
<b>SURCHARGES IN € (VAT NOT INCLUDED)</b>						
Antique colour	16,00	27,00	27,00	31,00	31,00	24,00
Pigment colours	21,00	41,00	41,00	46,00	46,00	38,00
Socks						
Foam BS 5852 Crib 5	5,00		8,00		8,00	
Decorative nails	29,00					
Reinforcement mesh						
Footrest plate						
Connection into rows						
Engraving						14,00
<b>TECHNICAL INFORMATION</b>						
Total width (cm)	38,8	58,4	58,4	65,2	65,2	59
Total depth (cm)	38,8	61,5	61,5	61,5	61,5	57
Total height (cm)	48	74,7	74,7	74,7	74,7	82
Armrest height (cm)				59,5	59,5	
Seat height (cm)	48	42	45	42	45	45,3
Width of seat (cm)	∅ 37	58,4	58,4	58,4	58,4	45
Depth of seat (cm)	∅ 37	46,3	46,3	46,3	46,3	47
Weight of product (kg)	2,7	4,7	5,1	5,2	5,6	5,5
Consumption of fabric (m)	0,177		0,318		0,318	
Consumption of leather (m²)	0,715		0,961		0,961	
Packing (pcs)	1	1	1	1	1	2
Volume (m³/pc)	0,113	0,391	0,391	0,391	0,391	0,229
Carton dimensions (cm)	43 × 43 × 53	66 × 62 × 83	66 × 62 × 83	66 × 62 × 83	66 × 62 × 83	66 × 59 × 102
Bicolour						
Stackability						4
Embossed seat/backrest						

2

**again**

Alexander Gufler

**albu**

Alexander Gufler



PRODUCT NUMBER	313 005	314 005	311 006	313 006	314 006	313 414
Type	chair	chair	barstool	barstool	barstool	chair
Seat option	upholstery	upholstery	veneer	upholstery	upholstery	upholstery
Back option	veneer	upholstery	veneer	veneer	upholstery	upholstery
Type of wood	beech	beech	beech	beech	beech	beech
<b>PRICES IN € (VAT NOT INCLUDED)</b>						
Veneer seat			585,00			
Upholstery - category A	567,00	661,00		663,00	752,00	919,00
Upholstery - category B	581,00	684,00		675,00	772,00	970,00
Upholstery - category C	592,00	703,00		685,00	789,00	1 012,00
Upholstery - category D	616,00	744,00		707,00	826,00	1 105,00
Upholstery - category E	677,00	849,00		762,00	920,00	1 339,00
Upholstery - category 1	600,00	697,00		692,00	784,00	1 279,00
Upholstery - category 2	659,00	777,00		745,00	855,00	1 749,00
Upholstery - COM	556,00	642,00		652,00	734,00	874,00
Cane						
Mesh Polo						
<b>SURCHARGES IN € (VAT NOT INCLUDED)</b>						
Antique colour	24,00	24,00	27,00	27,00	27,00	10,00
Pigment colours	38,00	38,00	45,00	45,00	45,00	17,00
Socks						
Foam BS 5852 Crib 5	5,00	8,00		5,00	8,00	15,00
Decorative nails						
Reinforcement mesh						
Footrest plate			25,00	25,00	25,00	
Connection into rows						
Engraving	14,00	14,00	14,00	14,00	14,00	
<b>TECHNICAL INFORMATION</b>						
			high/low	high/low	high/low	
Total width (cm)	59	59	55/55	55/55	55/55	58
Total depth (cm)	57	57	54/51	54/51	54/51	64
Total height (cm)	82	82	107,5/91	107,5/91	107,5/91	85
Armrest height (cm)						
Seat height (cm)	46,7	46,7	77,6/61	79/62,4	79/62,4	47
Width of seat (cm)	45	45	42/42	42/42	42/42	47
Depth of seat (cm)	47	47	44/44	44/44	42,5/42,5	47,5
Weight of product (kg)	6,1	6,4	6,5/6,1	6,9/6,5	7/6,6	8,7
Consumption of fabric (m)	0,605	1,040		0,550	0,930	2,333
Consumption of leather (m <sup>2</sup> )	0,726	0,990		0,660	0,880	5,832
Packing (pcs)	2	2	1	1	1	1
Volume (m <sup>3</sup> /pc)	0,229	0,229	0,452/0,395	0,452/0,395	0,452/0,395	0,393
Carton dimensions (cm)	66 × 59 × 102	66 × 59 × 102	60 × 56 × 117/ 59 × 57 × 102	60 × 56 × 117/ 59 × 57 × 102	60 × 56 × 117/ 59 × 57 × 102	65 × 59 × 89
Bicolour						
Stackability	4	4				
Embossed seat/backrest						

**albu**

Alexander Gufler

**banana** →

TON R&D



PRODUCT NUMBER	313 414	323 415	323 415	363 416	363 416	311 131
Type	chair	armchair	armchair	lounge armchair	lounge armchair	barstool
Seat option	upholstery	upholstery	upholstery	upholstery	upholstery	veneer
Back option	upholstery	upholstery	upholstery	upholstery	upholstery	
Type of wood	oak	beech	oak	beech	oak	beech
<b>PRICES IN € (VAT NOT INCLUDED)</b>						
Veneer seat						316,00
Upholstery - category A	1 001,00	968,00	1 050,00	1 047,00	1 129,00	
Upholstery - category B	1 052,00	1 020,00	1 102,00	1 105,00	1 187,00	
Upholstery - category C	1 094,00	1 062,00	1 144,00	1 153,00	1 235,00	
Upholstery - category D	1 187,00	1 156,00	1 238,00	1 260,00	1 342,00	
Upholstery - category E	1 421,00	1 393,00	1 475,00	1 527,00	1 609,00	
Upholstery - category 1	1 361,00	1 327,00	1 409,00	1 458,00	1 540,00	
Upholstery - category 2	1 831,00	1 797,00	1 879,00	1 994,00	2 076,00	
Upholstery - COM	956,00	923,00	1 005,00	996,00	1 078,00	
Cane						
Mesh Polo						
<b>SURCHARGES IN € (VAT NOT INCLUDED)</b>						
Antique colour		10,00		10,00		23,00
Pigment colours	17,00	17,00	17,00	17,00	17,00	45,00
Socks						15,00
Foam BS 5852 Crib 5	15,00	16,00	16,00	18,00	18,00	
Decorative nails						
Reinforcement mesh						
Footrest plate						19,00
Connection into rows						
Engraving						14,00
<b>TECHNICAL INFORMATION</b>						
						<b>high/low</b>
Total width (cm)	58	62	62	68	68	46/46
Total depth (cm)	64	64	64	75	75	47/47
Total height (cm)	85	85	85	84	84	107/92
Armrest height (cm)		65,5	65,5	57,5	57,5	
Seat height (cm)	47	47	47	41	41	76/61
Width of seat (cm)	47	47	47	52	52	39,5/39,5
Depth of seat (cm)	47,5	47,5	47,5	53	53	40,5/40,5
Weight of product (kg)	8,7	9,7	9,7	11,7	11,7	4,9/4,6
Consumption of fabric (m)	2,333	2,356	2,356	2,662	2,662	
Consumption of leather (m²)	5,832	5,832	5,832	6,655	6,655	
Packing (pcs)	1	1	1	1	1	1
Volume (m³/pc)	0,393	0,426	0,426	0,539	0,539	0,328/0,274
Carton dimensions (cm)	65 × 59 × 89	66 × 63 × 89	66 × 63 × 89	76 × 70 × 88	76 × 70 × 88	52 × 48 × 114/ 50 × 48 × 99
Bicolour						
Stackability						
Embossed seat/backrest						203, 209, 223, 255, 256

2

**banana**

TON R&D

**bergamo** →

Tom Kelley



PRODUCT NUMBER	313 131	315 131	311 769	313 769	315 769	311 710
Type	barstool	barstool	chair	chair	chair	chair
Seat option	upholstery	cane/mesh Polo	veneer	upholstery	cane/mesh Polo	veneer
Back option						
Type of wood	beech	beech	beech	beech	beech	beech
<b>PRICES IN € (VAT NOT INCLUDED)</b>						
Veneer seat			240,00			299,00
Upholstery - category A	332,00			256,00		
Upholstery - category B	336,00			260,00		
Upholstery - category C	339,00			263,00		
Upholstery - category D	347,00			271,00		
Upholstery - category E	365,00			289,00		
Upholstery - category 1	366,00			290,00		
Upholstery - category 2	408,00			332,00		
Upholstery - COM	329,00			253,00		
Cane		389,00			313,00	
Mesh Polo		417,00			341,00	
<b>SURCHARGES IN € (VAT NOT INCLUDED)</b>						
Antique colour	23,00	23,00	19,00	19,00	19,00	20,00
Pigment colours	45,00	45,00	33,00	33,00	33,00	31,00
Socks	15,00	15,00	15,00	15,00	15,00	
Foam BS 5852 Crib 5	5,00			5,00		
Decorative nails	29,00			29,00		
Reinforcement mesh		28,00			28,00	
Footrest plate	19,00	19,00				
Connection into rows						
Engraving	14,00	14,00	14,00	14,00	14,00	14,00
<b>TECHNICAL INFORMATION</b>	<b>high/low</b>	<b>high/low</b>				
Total width (cm)	46/46	46/46	46	46	46	48
Total depth (cm)	47/47	47/47	48,5	48,5	48,5	51
Total height (cm)	105/90	107/92	82	82	82	83,7
Armrest height (cm)						
Seat height (cm)	76/61	76/61	46	46	46	46
Width of seat (cm)	39,5/39,5	39,5/39,5	39,5	39,5	39,5	42
Depth of seat (cm)	40,5/40,5	40,5/40,5	40,5	40,5	40,5	44
Weight of product (kg)	5,2/4,9	4,9/4,6	3,7	4,1	3,7	6
Consumption of fabric (m)	0,182			0,182		
Consumption of leather (m <sup>2</sup> )	0,528			0,528		
Packing (pcs)	1	1	2	2	2	2
Volume (m <sup>3</sup> /pc)	0,328/0,274	0,328/0,274	0,170	0,170	0,170	0,235
Carton dimensions (cm)	52 × 48 × 114/ 50 × 48 × 99	52 × 48 × 114/ 50 × 48 × 99	62 × 47 × 101	62 × 47 × 101	62 × 47 × 101	72 × 55 × 103
Bicolour						
Stackability						4
Embossed seat/backrest			203, 209, 223, 255, 256			

# bergamo

Tom Kelley

# casablanca

Tom Kelley

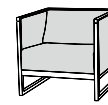
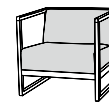
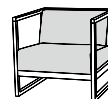

PRODUCT NUMBER	313 710	321 710	323 710	363 681	363 681	363 683
Type	chair	armchair	armchair	lounge armchair	lounge armchair	lounge armchair
Seat option	upholstery	veneer	upholstery	upholstery	upholstery	upholstery
Back option				upholstery	upholstery	upholstery
Type of wood	beech	beech	beech	beech	oak	beech
<b>PRICES IN € (VAT NOT INCLUDED)</b>						
Veneer seat		390,00				
Upholstery - category A	300,00		391,00	1 116,00	1 257,00	1 249,00
Upholstery - category B	308,00		399,00	1 174,00	1 315,00	1 334,00
Upholstery - category C	313,00		404,00	1 222,00	1 363,00	1 403,00
Upholstery - category D	326,00		417,00	1 328,00	1 469,00	1 557,00
Upholstery - category E	359,00		450,00	1 595,00	1 736,00	1 944,00
Upholstery - category 1	352,00		443,00	1 514,00	1 655,00	1 702,00
Upholstery - category 2	418,00		509,00	2 037,00	2 178,00	2 331,00
Upholstery - COM	294,00		385,00	1 066,00	1 207,00	1 175,00
Cane						
Mesh Polo						
<b>SURCHARGES IN € (VAT NOT INCLUDED)</b>						
Antique colour	20,00	23,00	23,00	32,00		32,00
Pigment colours	31,00	38,00	38,00	61,00	61,00	61,00
Socks						
Foam BS 5852 Crib 5	5,00		5,00	45,00	45,00	55,00
Decorative nails						
Reinforcement mesh						
Footrest plate						
Connection into rows						
Engraving	14,00	14,00	14,00			
<b>TECHNICAL INFORMATION</b>						
Total width (cm)	48	57	57	70	70	70
Total depth (cm)	51	51,5	51,5	70	70	70
Total height (cm)	82	83,7	82	67	67	67
Armrest height (cm)		67,7	66	67	67	67
Seat height (cm)	47	46	47	40	40	40
Width of seat (cm)	42	41,6	41,6	63	63	63
Depth of seat (cm)	44	44	44	45	45	45
Weight of product (kg)	5,7	7,5	7,2	17,6	17,6	21
Consumption of fabric (m)	0,323		0,323	2,657	2,657	3,858
Consumption of leather (m²)	0,825		0,825	6,490	6,490	7,810
Packing (pcs)	2	1	1	1	1	1
Volume (m³/pc)	0,235	0,350	0,350	0,466	0,466	0,466
Carton dimensions (cm)	72 × 55 × 103	60 × 57 × 89	60 × 57 × 89	75 × 75 × 72	75 × 75 × 72	75 × 75 × 72
Bicolour						
Stackability	4	4	4			
Embossed seat/backrest						



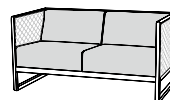
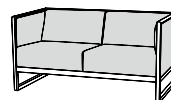
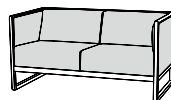
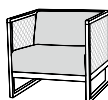
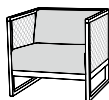
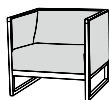

PRODUCT NUMBER	363 683	367 683	367 683	383 684	383 684	387 684
Type	lounge armchair	lounge armchair	lounge armchair	two-seater sofa	two-seater sofa	two-seater sofa
Seat option	upholstery	upholstery	upholstery	upholstery	upholstery	upholstery
Back option	upholstery	upholstery	upholstery	upholstery	upholstery	upholstery
Type of wood	oak	beech	oak	beech	oak	beech
<b>PRICES IN € (VAT NOT INCLUDED)</b>						
Veneer seat						
Upholstery - category A	1 390,00	1 494,00	1 635,00	1 847,00	2 039,00	2 031,00
Upholstery - category B	1 475,00	1 552,00	1 693,00	1 979,00	2 171,00	2 125,00
Upholstery - category C	1 544,00	1 600,00	1 741,00	2 086,00	2 278,00	2 201,00
Upholstery - category D	1 698,00	1 706,00	1 847,00	2 326,00	2 518,00	2 371,00
Upholstery - category E	2 085,00	1 973,00	2 114,00	2 926,00	3 118,00	2 797,00
Upholstery - category 1	1 843,00	1 892,00	2 033,00	2 771,00	2 963,00	2 687,00
Upholstery - category 2	2 472,00	2 415,00	2 556,00	3 976,00	4 168,00	3 543,00
Upholstery - COM	1 316,00	1 444,00	1 585,00	1 733,00	1 925,00	1 950,00
Cane						
Mesh Polo						
<b>SURCHARGES IN € (VAT NOT INCLUDED)</b>						
Antique colour		32,00		38,00		38,00
Pigment colours	61,00	61,00	61,00	72,00	72,00	72,00
Socks						
Foam BS 5852 Crib 5	55,00	45,00	45,00	85,00	85,00	75,00
Decorative nails						
Reinforcement mesh						
Footrest plate						
Connection into rows						
Engraving						
<b>TECHNICAL INFORMATION</b>						
Total width (cm)	70	70	70	134	134	134
Total depth (cm)	70	70	70	70	70	70
Total height (cm)	67	67	67	67	67	67
Armrest height (cm)	67	67	67	67	67	67
Seat height (cm)	40	40	40	40	40	40
Width of seat (cm)	63	63	63	126	126	126
Depth of seat (cm)	45	45	45	45	45	45
Weight of product (kg)	21	18,4	18,4	38	38	35,4
Consumption of fabric (m)	3,858	2,657	2,657	5,983	5,983	4,250
Consumption of leather (m <sup>2</sup> )	7,810	6,490	6,490	14,960	14,960	10,626
Packing (pcs)	1	1	1	1	1	1
Volume (m <sup>3</sup> /pc)	0,466	0,466	0,466	0,864	0,864	0,864
Carton dimensions (cm)	75 × 75 × 72	75 × 75 × 72	75 × 75 × 72	139 × 75 × 72	139 × 75 × 72	139 × 75 × 72
Bicolour						
Stackability						
Embossed seat/backrest						

# casablanca

Tom Kelley

# Chips

Lucie Koldova

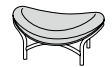
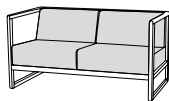
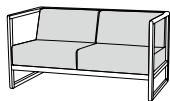
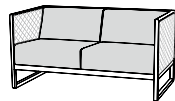

PRODUCT NUMBER	387 684	383 685	383 685	363 601	363 601	373 602
Type	two-seater sofa	two-seater sofa	two-seater sofa	lounge chair ***	lounge chair ***	stool
Seat option	upholstery	upholstery	upholstery	upholstery	upholstery	upholstery
Back option	upholstery	upholstery	upholstery	mesh Polo	mesh Polo	
Type of wood	oak	beech	oak	beech	ash	beech
<b>PRICES IN € (VAT NOT INCLUDED)</b>						
Veneer seat						
Upholstery - category A	2 223,00	1 788,00	1 980,00	3 113,00	3 841,00	826,00
Upholstery - category B	2 317,00	1 882,00	2 074,00	3 176,00	3 904,00	859,00
Upholstery - category C	2 393,00	1 958,00	2 150,00	3 227,00	3 955,00	886,00
Upholstery - category D	2 563,00	2 128,00	2 320,00	3 340,00	4 068,00	946,00
Upholstery - category E	2 989,00	2 554,00	2 746,00	3 624,00	4 352,00	1 097,00
Upholstery - category 1	2 879,00	2 444,00	2 636,00	3 548,00	4 276,00	1 057,00
Upholstery - category 2	3 735,00	3 300,00	3 492,00	4 115,00	4 843,00	1 358,00
Upholstery - COM	2 142,00	1 707,00	1 899,00	3 060,00	3 788,00	798,00
Cane						
Mesh Polo						
<b>SURCHARGES IN € (VAT NOT INCLUDED)</b>						
Antique colour		38,00		32,00		15,00
Pigment colours	72,00	72,00	72,00	48,00	48,00	23,00
Socks						
Foam BS 5852 Crib 5	75,00	75,00	75,00	65,00	65,00	43,00
Decorative nails						
Reinforcement mesh						
Footrest plate						
Connection into rows						
Engraving						
<b>TECHNICAL INFORMATION</b>						
Total width (cm)	134	134	134	94,6	94,6	94
Total depth (cm)	70	70	70	89,5	89,5	60
Total height (cm)	67	67	67	120,5	120,5	47
Armrest height (cm)	67	67	67			
Seat height (cm)	40	40	40	35,5	35,5	35
Width of seat (cm)	126	126	126	94,6	94,6	94
Depth of seat (cm)	45	45	45	72,5	72,5	60
Weight of product (kg)	35,4	34,6	34,6	20	20	12,9
Consumption of fabric (m)	4,250	4,250	4,250	2,829	2,829	1,502
Consumption of leather (m²)	10,626	10,626	10,626	7,040	7,040	3,740
Packing (pcs)	1	1	1	1	1	1
Volume (m³/pc)	0,864	0,864	0,864	1,974	1,974	0,379
Carton dimensions (cm)	139 × 75 × 72	139 × 75 × 72	139 × 75 × 72	102 × 122 × 145	102 × 122 × 145	64 × 97 × 53
Bicolour						
Stackability						
Embossed seat/backrest						

\*\*\* For technical reasons, the back cushion for Chips lounge chair (363 601) is not available in artificial leather, pigment leather or customer's own materials.

**chips**

Lucie Koldová

**dejavu\_054**

TON R&amp;D

**dejavu\_378** →

TON R&amp;D



PRODUCT NUMBER	373 602	311 054	313 054	315 054	311 378	313 378
Type	stool	chair	chair	chair	chair	chair
Seat option	upholstery	veneer	upholstery	cane/mesh Polo	veneer	upholstery
Back option						
Type of wood	ash	beech	beech	beech	beech	beech
<b>PRICES IN € (VAT NOT INCLUDED)</b>						
Veneer seat		250,00			295,00	
Upholstery - category A	1 078,00		266,00			316,00
Upholstery - category B	1 111,00		270,00			320,00
Upholstery - category C	1 138,00		273,00			323,00
Upholstery - category D	1 198,00		281,00			330,00
Upholstery - category E	1 349,00		299,00			348,00
Upholstery - category 1	1 309,00		300,00			349,00
Upholstery - category 2	1 610,00		342,00			392,00
Upholstery - COM	1 050,00		263,00			312,00
Cane				323,00		
Mesh Polo				351,00		
<b>SURCHARGES IN € (VAT NOT INCLUDED)</b>						
Antique colour		19,00	19,00	19,00	19,00	19,00
Pigment colours	23,00	35,00	35,00	35,00	30,00	30,00
Socks		15,00	15,00	15,00	15,00	15,00
Foam BS 5852 Crib 5	43,00		5,00			5,00
Decorative nails			29,00			29,00
Reinforcement mesh				28,00		
Footrest plate						
Connection into rows						
Engraving		14,00	14,00	14,00		
<b>TECHNICAL INFORMATION</b>						
Total width (cm)	94	43	43	43	40,5	40,5
Total depth (cm)	60	51,3	51,3	51,3	48	48
Total height (cm)	47	90	90	90	86,5	86,5
Armrest height (cm)						
Seat height (cm)	35	46	46	46	46	46
Width of seat (cm)	94	39,5	39,5	39,5	ø 40,5	ø 40,5
Depth of seat (cm)	60	40,5	40,5	40,5	ø 40,5	ø 40,5
Weight of product (kg)	12,9	3,7	3,9	3,7	3,4	3,6
Consumption of fabric (m)	1,502		0,182			0,182
Consumption of leather (m <sup>2</sup> )	3,740		0,528			0,528
Packing (pcs)	1	2	2	2	2	2
Volume (m <sup>3</sup> /pc)	0,379	0,168	0,168	0,168	0,153	0,153
Carton dimensions (cm)	64 × 97 × 53	64 × 45 × 101	64 × 45 × 101	64 × 45 × 101	59 × 45 × 100	59 × 45 × 100
Bicolour						
Stackability						
Embossed seat/backrest		203, 208, 209, 223, 255, 256			202, 206, 219, 259	

# Dejavu\_378 Dowel

TON R&D

Lime studio

# era\_388 →

René Šulc

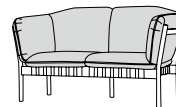
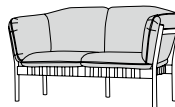
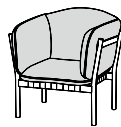
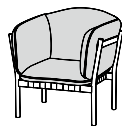

PRODUCT NUMBER	315 378	363 392	363 392	363 394	363 394	311 388
Type	chair	lounge armchair	lounge armchair	two-seater lounge	two-seater lounge	chair
Seat option	cane/mesh Polo	upholstery	upholstery	upholstery	upholstery	veneer
Back option		upholstery	upholstery	upholstery	upholstery	
Type of wood	beech	beech	oak	beech	oak	beech
<b>PRICES IN € (VAT NOT INCLUDED)</b>						
Veneer seat						387,00
Upholstery - category A		1 359,00	1 492,00	2 535,00	2 757,00	
Upholstery - category B		1 435,00	1 568,00	2 670,00	2 892,00	
Upholstery - category C		1 498,00	1 631,00	2 781,00	3 003,00	
Upholstery - category D		1 636,00	1 769,00	3 026,00	3 248,00	
Upholstery - category E		1 984,00	2 117,00	3 643,00	3 865,00	
Upholstery - category 1		1 894,00	2 027,00	3 484,00	3 706,00	
Upholstery - category 2		2 592,00	2 725,00	4 721,00	4 943,00	
Upholstery - COM		1 293,00	1 426,00	2 418,00	2 640,00	
Cane	356,00					
Mesh Polo	384,00					
<b>SURCHARGES IN € (VAT NOT INCLUDED)</b>						
Antique colour	19,00	28,00		46,00		16,00
Pigment colours	30,00	52,00	52,00	85,00	85,00	40,00
Socks	15,00					
Foam BS 5852 Crib 5		*	*	*	*	
Decorative nails						
Reinforcement mesh	28,00					
Footrest plate						
Connection into rows						
Engraving						14,00
<b>TECHNICAL INFORMATION</b>						
Total width (cm)	40,5	80,5	80,5	147	147	43
Total depth (cm)	48	72,5	72,5	72,5	72,5	50
Total height (cm)	86,5	85	85	85	85	88
Armrest height (cm)		75,5	75,5	75,5	75,5	
Seat height (cm)	46	42	42	42	42	46
Width of seat (cm)	∅ 40,5	45	45	107	107	40
Depth of seat (cm)	∅ 40,5	52	52	52	52	40
Weight of product (kg)	3,4	10,5	10,5	19	19	4
Consumption of fabric (m)		3,465	3,465	6,145	6,145	
Consumption of leather (m²)		8,663	8,663	15,362	15,362	
Packing (pcs)	2	1	1	1	1	2
Volume (m³/pc)	0,153	0,664	0,664	1,114	1,114	0,176
Carton dimensions (cm)	59 × 45 × 100	84 × 79 × 87	84 × 79 × 87	149 × 73 × 89	149 × 73 × 89	66 × 45 × 103
Bicolour						
Stackability						
Embossed seat/backrest						

\* The price is already inclusive of the surcharge.

## era\_388

René Šulc

## ginger\_37

Yonoh

## ideal →

TON R&amp;D



PRODUCT NUMBER	311 388	313 388	313 388	323 379	323 379	311 488
Type	chair	chair	chair	armchair	armchair	chair
Seat option	veneer	upholstery	upholstery	upholstery	upholstery	veneer
Back option				upholstery	upholstery	
Type of wood	oak	beech	oak	beech	oak	beech
<b>PRICES IN € (VAT NOT INCLUDED)</b>						
Veneer seat	<b>646,00</b>					<b>195,00</b>
Upholstery - category A		<b>515,00</b>	<b>774,00</b>	<b>709,00</b>	<b>758,00</b>	
Upholstery - category B		<b>522,00</b>	<b>781,00</b>	<b>751,00</b>	<b>800,00</b>	
Upholstery - category C		<b>529,00</b>	<b>788,00</b>	<b>785,00</b>	<b>834,00</b>	
Upholstery - category D		<b>542,00</b>	<b>801,00</b>	<b>861,00</b>	<b>910,00</b>	
Upholstery - category E		<b>577,00</b>	<b>836,00</b>	<b>1 051,00</b>	<b>1 100,00</b>	
Upholstery - category 1		<b>552,00</b>	<b>811,00</b>	<b>984,00</b>	<b>1 033,00</b>	
Upholstery - category 2		<b>605,00</b>	<b>864,00</b>	<b>1 347,00</b>	<b>1 396,00</b>	
Upholstery - COM		<b>508,00</b>	<b>767,00</b>	<b>673,00</b>	<b>722,00</b>	
Cane						
Mesh Polo						
<b>SURCHARGES IN € (VAT NOT INCLUDED)</b>						
Antique colour		<b>16,00</b>		<b>10,00</b>		<b>20,00</b>
Pigment colours	<b>40,00</b>	<b>40,00</b>	<b>40,00</b>	<b>13,00</b>	<b>13,00</b>	<b>37,00</b>
Socks						
Foam BS 5852 Crib 5		<b>5,00</b>	<b>5,00</b>	<b>23,00</b>	<b>23,00</b>	
Decorative nails						
Reinforcement mesh						
Footrest plate						
Connection into rows						
Engraving	<b>14,00</b>	<b>14,00</b>	<b>14,00</b>			<b>14,00</b>
<b>TECHNICAL INFORMATION</b>						
Total width (cm)	43	43	43	57,5	57,5	45
Total depth (cm)	50	50	50	59	59	48,5
Total height (cm)	88	88	88	83	83	84
Armrest height (cm)				67,5	67,5	
Seat height (cm)	46	47,5	47,5	48	48	46
Width of seat (cm)	40	40	40	43,5	43,5	40
Depth of seat (cm)	40	40	40	43	43	40
Weight of product (kg)	4	4,9	4,9	6,9	6,9	4,6
Consumption of fabric (m)		0,347	0,347	1,802	1,802	
Consumption of leather (m <sup>2</sup> )		0,660	0,660	4,505	4,505	
Packing (pcs)	2	2	2	1	1	2
Volume (m <sup>3</sup> /pc)	0,176	0,176	0,176	0,390	0,390	0,177
Carton dimensions (cm)	66 × 45 × 103	66 × 45 × 103	66 × 45 × 103	61 × 61 × 91	61 × 61 × 91	64 × 47 × 102
Bicolour						
Stackability						
Embossed seat/backrest						

ideal

TON R&amp;D

ironica

TON R&amp;D



PRODUCT NUMBER	313 488	311 485	313 485	311 035	311 035	313 035
Type	chair	barstool	barstool	chair	chair	chair
Seat option	upholstery	veneer	upholstery	veneer	veneer	upholstery
Back option						
Type of wood	beech	beech	beech	beech	oak	beech
<b>PRICES IN € (VAT NOT INCLUDED)</b>						
Veneer seat		256,00		161,00	258,00	
Upholstery - category A	208,00		269,00			207,00
Upholstery - category B	212,00		273,00			213,00
Upholstery - category C	215,00		276,00			218,00
Upholstery - category D	222,00		283,00			229,00
Upholstery - category E	240,00		301,00			256,00
Upholstery - category 1	235,00		296,00			237,00
Upholstery - category 2	271,00		332,00			278,00
Upholstery - COM	205,00		266,00			202,00
Cane						
Mesh Polo						
<b>SURCHARGES IN € (VAT NOT INCLUDED)</b>						
Antique colour	20,00	24,00	24,00	20,00		20,00
Pigment colours	37,00	49,00	49,00	34,00	34,00	34,00
Socks				15,00		15,00
Foam BS 5852 Crib 5	5,00		5,00			5,00
Decorative nails						
Reinforcement mesh						
Footrest plate		19,00	19,00			
Connection into rows						
Engraving	14,00	14,00	14,00			
<b>TECHNICAL INFORMATION</b>						
		high/low	high/low			
Total width (cm)	45	43/43	43/43	44	44	44
Total depth (cm)	48,5	47/47	47/47	47	47	47
Total height (cm)	84	109/94	107/92	84,5	84,5	84,5
Armrest height (cm)						
Seat height (cm)	48	76/61	76/61	45	45	47
Width of seat (cm)	40	40/40	40/40	41	41	41
Depth of seat (cm)	40	40/40	40/40	36,5	36,5	36,5
Weight of product (kg)	4,9	6/5,6	6,3/5,9	3,6	3,6	4,3
Consumption of fabric (m)	0,177		0,177			0,182
Consumption of leather (m²)	0,440		0,440			0,495
Packing (pcs)	2	1	1	2	2	2
Volume (m³/pc)	0,177	0,348/0,273	0,348/0,273	0,170	0,170	0,170
Carton dimensions (cm)	64 × 47 × 102	55 × 47 × 117/ 52 × 47 × 97	55 × 47 × 117/ 52 × 47 × 97	62 × 47 × 101	62 × 47 × 101	62 × 47 × 101
Bicolour						
Stackability						
Embossed seat/backrest						

2

ironica

TON R&D

kontor\_503 →

TON R&D

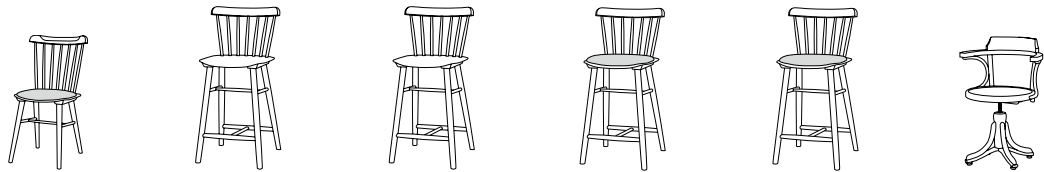

PRODUCT NUMBER	313 035	311 115	311 115	313 115	313 115	351 503
Type	chair	barstool	barstool	barstool	barstool	revolving armchair
Seat option	upholstery	veneer	veneer	upholstery	upholstery	veneer
Back option						
Type of wood	oak	beech	oak	beech	oak	beech
<b>PRICES IN € (VAT NOT INCLUDED)</b>						
Veneer seat		259,00	387,00			673,00
Upholstery - category A	304,00			305,00	433,00	
Upholstery - category B	310,00			311,00	439,00	
Upholstery - category C	315,00			316,00	444,00	
Upholstery - category D	326,00			327,00	455,00	
Upholstery - category E	353,00			354,00	482,00	
Upholstery - category 1	334,00			335,00	463,00	
Upholstery - category 2	375,00			376,00	504,00	
Upholstery - COM	299,00			300,00	428,00	
Cane						
Mesh Polo						
<b>SURCHARGES IN € (VAT NOT INCLUDED)</b>						
Antique colour		25,00		25,00		24,00
Pigment colours	34,00	43,00	43,00	43,00	43,00	46,00
Socks		15,00		15,00		
Foam BS 5852 Crib 5	5,00			5,00	5,00	
Decorative nails						
Reinforcement mesh						
Footrest plate						
Connection into rows						
Engraving						14,00
<b>TECHNICAL INFORMATION</b>		<b>high/low</b>	<b>high/low</b>	<b>high/low</b>	<b>high/low</b>	
Total width (cm)	44	45/44	45/44	45/44	45/44	57
Total depth (cm)	47	52/46	52/46	52/46	52/46	57
Total height (cm)	84,5	109,5/90,5	109,5/90,5	109,5/90,5	109,5/90,5	79-93
Armrest height (cm)						69,5-83,5
Seat height (cm)	47	80/61	80/61	82/63	82/63	44-58
Width of seat (cm)	41	41/41	41/41	41/41	41/41	ø 48
Depth of seat (cm)	36,5	36,5/36,5	36,5/36,5	36,5/36,5	36,5/36,5	ø 48
Weight of product (kg)	4,3	4,9/4,5	4,9/4,5	5,6/5,2	5,6/5,2	9
Consumption of fabric (m)	0,182			0,182	0,182	
Consumption of leather (m²)	0,495			0,495	0,495	
Packing (pcs)	2	1	1	1	1	1
Volume (m³/pc)	0,170	0,375/0,274	0,375/0,274	0,375/0,274	0,375/0,274	0,293
Carton dimensions (cm)	62 × 47 × 101	56 × 51 × 114/ 50 × 48 × 99	56 × 51 × 114/ 50 × 48 × 99	56 × 51 × 114/ 50 × 48 × 99	56 × 51 × 114/ 50 × 48 × 99	55 × 55 × 84
Bicolour						
Stackability						
Embossed seat/backrest						202, 206, 259



PRODUCT NUMBER	353 503	355 503	351 523	353 523	355 523	311 437
Type	revolving armchair	revolving armchair	revolving armchair	revolving armchair	revolving armchair	chair
Seat option	upholstery	cane/mesh Polo	veneer	upholstery	cane/mesh Polo	veneer
Back option						veneer
Type of wood	beech	beech	beech	beech	beech	beech
<b>PRICES IN € (VAT NOT INCLUDED)</b>						
Veneer seat			709,00			383,00
Upholstery - category A	691,00			727,00		
Upholstery - category B	698,00			734,00		
Upholstery - category C	704,00			740,00		
Upholstery - category D	716,00			752,00		
Upholstery - category E	748,00			784,00		
Upholstery - category 1	738,00			774,00		
Upholstery - category 2	800,00			836,00		
Upholstery - COM	685,00			721,00		
Cane		756,00			792,00	
Mesh Polo		784,00			820,00	
<b>SURCHARGES IN € (VAT NOT INCLUDED)</b>						
Antique colour	24,00	24,00	25,00	25,00	25,00	19,00
Pigment colours	46,00	46,00	48,00	48,00	48,00	76,00
Socks						
Foam BS 5852 Crib 5	7,00			7,00		
Decorative nails	37,00			37,00		
Reinforcement mesh		28,00			28,00	
Footrest plate						
Connection into rows						
Engraving	14,00	14,00	14,00	14,00	14,00	14,00
<b>TECHNICAL INFORMATION</b>						
Total width (cm)	57	57	57	57	57	50,5
Total depth (cm)	57	57	57	57	57	52
Total height (cm)	79-93	79-93	79-93	79-93	79-93	80
Armrest height (cm)	69,5-83,5	69,5-83,5	69,5-83,5	69,5-83,5	69,5-83,5	
Seat height (cm)	46-60	44-58	44-58	46-60	44-58	45,7
Width of seat (cm)	ø 48	ø 48	ø 48	ø 48	ø 48	43,5
Depth of seat (cm)	ø 48	ø 48	ø 48	ø 48	ø 48	40
Weight of product (kg)	9,3	9	9,1	9,4	9,1	4
Consumption of fabric (m)	0,318			0,318		
Consumption of leather (m²)	0,770			0,770		
Packing (pcs)	1	1	1	1	1	2
Volume (m³/pc)	0,293	0,293	0,293	0,293	0,293	0,215
Carton dimensions (cm)	55 × 55 × 84	55 × 55 × 84	55 × 55 × 84	55 × 55 × 84	55 × 55 × 84	67 × 53 × 105
Bicolour						
Stackability						
Embossed seat/backrest			202, 206, 259			





PRODUCT NUMBER	311 437	313 437	313 437	321 437	321 437	323 437
Type	chair	chair	chair	armchair	armchair	armchair
Seat option	veneer	upholstery	upholstery	veneer	veneer	upholstery
Back option	veneer	upholstery	upholstery	veneer	veneer	veneer
Type of wood	oak	beech	oak	beech	oak	beech
<b>PRICES IN € (VAT NOT INCLUDED)</b>						
Veneer seat	573,00			502,00	753,00	
Upholstery - category A		653,00	815,00			727,00
Upholstery - category B		667,00	829,00			737,00
Upholstery - category C		679,00	841,00			745,00
Upholstery - category D		705,00	867,00			762,00
Upholstery - category E		770,00	932,00			805,00
Upholstery - category 1		753,00	915,00			794,00
Upholstery - category 2		883,00	1 045,00			882,00
Upholstery - COM		640,00	802,00			719,00
Cane						
Mesh Polo						
<b>SURCHARGES IN € (VAT NOT INCLUDED)</b>						
Antique colour		19,00		20,00		20,00
Pigment colours	41,00	76,00	41,00	71,00	44,00	71,00
Socks						
Foam BS 5852 Crib 5		10,00	10,00			7,00
Decorative nails						
Reinforcement mesh						
Footrest plate						
Connection into rows						
Engraving	14,00	14,00	14,00	14,00	14,00	14,00
<b>TECHNICAL INFORMATION</b>						
Total width (cm)	50,5	50	50	59,5	59,5	59,5
Total depth (cm)	52	51,7	51,7	52	52	51,7
Total height (cm)	80	78,5	78,5	80	80	78,5
Armrest height (cm)				70	70	68,5
Seat height (cm)	45,7	47	47	45,7	45,7	47
Width of seat (cm)	43,5	43,5	43,5	43,5	43,5	43,5
Depth of seat (cm)	40	40	40	40	40	40
Weight of product (kg)	4	5,3	5,3	4,4	4,4	5,2
Consumption of fabric (m)		0,649	0,649			0,435
Consumption of leather (m <sup>2</sup> )		1,623	1,623			1,087
Packing (pcs)	2	2	2	1	1	1
Volume (m <sup>3</sup> /pc)	0,215	0,215	0,215	0,371	0,371	0,371
Carton dimensions (cm)	67 × 53 × 105	67 × 53 × 105	67 × 53 × 105	65 × 57 × 87	65 × 57 × 87	65 × 57 × 87
Bicolour						
Stackability						
Embossed seat/backrest						

## leaf

E-ggs



PRODUCT NUMBER	323 437	371 438	371 438	373 438	373 438	311 439
Type	armchair	barstool	barstool	barstool	barstool	barstool
Seat option	upholstery	veneer	veneer	upholstery	upholstery	veneer
Back option	veneer					veneer
Type of wood	oak	beech	oak	beech	oak	beech
<b>PRICES IN € (VAT NOT INCLUDED)</b>						
Veneer seat		463,00	670,00			459,00
Upholstery - category A	938,00			640,00	822,00	
Upholstery - category B	948,00			648,00	830,00	
Upholstery - category C	956,00			654,00	836,00	
Upholstery - category D	973,00			667,00	849,00	
Upholstery - category E	1 016,00			701,00	883,00	
Upholstery - category 1	1 005,00			691,00	873,00	
Upholstery - category 2	1 093,00			757,00	939,00	
Upholstery - COM	930,00			634,00	816,00	
Cane						
Mesh Polo						
<b>SURCHARGES IN € (VAT NOT INCLUDED)</b>						
Antique colour		14,00		14,00		21,00
Pigment colours	44,00	52,00	28,00	52,00	28,00	81,00
Socks						
Foam BS 5852 Crib 5	7,00			5,00	5,00	
Decorative nails						
Reinforcement mesh						
Footrest plate		23,00	23,00	23,00	23,00	23,00
Connection into rows						
Engraving	14,00					14,00
<b>TECHNICAL INFORMATION</b>						
		high/low	high/low	high/low	high/low	high/low
Total width (cm)	59,5	46,2/44,5	46,2/44,5	46,2/44,5	46,2/44,5	52/50
Total depth (cm)	51,7	49/45,2	49/45,2	49/45,2	49/45,2	51/50
Total height (cm)	78,5	76/61	76/61	78,5/63,5	78,5/63,5	103,5/88
Armrest height (cm)	68,5					
Seat height (cm)	47	76/61	76/61	78,5/63,5	78,5/63,5	76/61
Width of seat (cm)	43,5	41	41	42	42	44
Depth of seat (cm)	40	37	37	38,5	38,5	39
Weight of product (kg)	5,2	4,4/4,1	4,4/4,1	5,4/5,1	5,4/5,1	5,7/5,4
Consumption of fabric (m)	0,435			0,336	0,336	
Consumption of leather (m²)	1,087			0,825	0,825	
Packing (pcs)	1	1	1	1	1	1
Volume (m³/pc)	0,371	0,250/0,186	0,250/0,186	0,250/0,186	0,250/0,186	0,377/0,306
Carton dimensions (cm)	65 × 57 × 87	53 × 50 × 82/ 49 × 49 × 67	53 × 50 × 82/ 49 × 49 × 67	53 × 50 × 82/ 49 × 49 × 67	53 × 50 × 82/ 49 × 49 × 67	56 × 54 × 108/ 54 × 53 × 93
Bicolour						
Stackability						
Embossed seat/backrest						

leaf

E-ggs

lyon

Tom Kelley

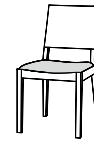

PRODUCT NUMBER	311 439	313 439	313 439	313 514	313 514	323 514
Type	barstool	barstool	barstool	chair	chair	armchair
Seat option	veneer	upholstery	upholstery	upholstery	upholstery	upholstery
Back option	veneer	upholstery	upholstery			
Type of wood	oak	beech	oak	beech	oak	beech
<b>PRICES IN € (VAT NOT INCLUDED)</b>						
Veneer seat	714,00					
Upholstery - category A		738,00	913,00	355,00	512,00	449,00
Upholstery - category B		751,00	926,00	362,00	519,00	456,00
Upholstery - category C		762,00	937,00	368,00	525,00	463,00
Upholstery - category D		787,00	962,00	382,00	539,00	476,00
Upholstery - category E		848,00	1 023,00	416,00	573,00	510,00
Upholstery - category 1		832,00	1 007,00	405,00	562,00	512,00
Upholstery - category 2		954,00	1 129,00	472,00	629,00	592,00
Upholstery - COM		726,00	901,00	348,00	505,00	442,00
Cane						
Mesh Polo						
<b>SURCHARGES IN € (VAT NOT INCLUDED)</b>						
Antique colour		21,00		20,00		24,00
Pigment colours	49,00	81,00	49,00	36,00	36,00	37,00
Socks						
Foam BS 5852 Crib 5		10,00	10,00	5,00	5,00	5,00
Decorative nails						
Reinforcement mesh						
Footrest plate	23,00	23,00	23,00			
Connection into rows						
Engraving	14,00	14,00	14,00	14,00	14,00	14,00
<b>TECHNICAL INFORMATION</b>						
	high/low	high/low	high/low			
Total width (cm)	52/50	52/50	52/50	46	46	56,5
Total depth (cm)	51/50	51/50	51/50	58	58	58,5
Total height (cm)	103,5/88	103,5/88,3	103,5/88,3	86	86	86
Armrest height (cm)						68,5
Seat height (cm)	76/61	80/64,5	80/64,5	47	47	47
Width of seat (cm)	44	44	44	46	46	48
Depth of seat (cm)	39	39	39	48,5	48,5	49
Weight of product (kg)	5,7/5,4	6,9/6,6	6,9/6,6	5,8	5,8	7,4
Consumption of fabric (m)		0,608	0,608	0,341	0,341	0,341
Consumption of leather (m <sup>2</sup> )		1,520	1,520	0,825	0,825	0,990
Packing (pcs)	1	1	1	2	2	1
Volume (m <sup>3</sup> /pc)	0,377/0,306	0,377/0,306	0,377/0,306	0,235	0,235	0,357
Carton dimensions (cm)	56 × 54 × 108/ 54 × 53 × 93	56 × 54 × 108/ 54 × 53 × 93	56 × 54 × 108/ 54 × 53 × 93	72 × 55 × 103	72 × 55 × 103	59 × 59 × 89
Bicolour						
Stackability						
Embossed seat/backrest						

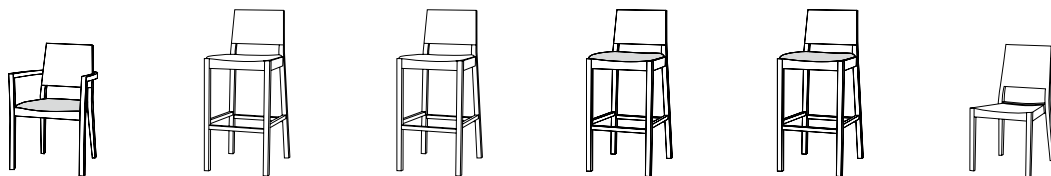

PRODUCT NUMBER	323 514	311 515	311 515	313 515	313 515	311 516
Type	armchair	barstool	barstool	barstool	barstool	chair
Seat option	upholstery	veneer	veneer	upholstery	upholstery	veneer
Back option						
Type of wood	oak	beech	oak	beech	oak	beech
<b>PRICES IN € (VAT NOT INCLUDED)</b>						
Veneer seat		436,00	648,00			373,00
Upholstery - category A	636,00			390,00	565,00	
Upholstery - category B	643,00			398,00	573,00	
Upholstery - category C	650,00			404,00	579,00	
Upholstery - category D	663,00			417,00	592,00	
Upholstery - category E	697,00			450,00	625,00	
Upholstery - category 1	699,00			429,00	604,00	
Upholstery - category 2	779,00			482,00	657,00	
Upholstery - COM	629,00			384,00	559,00	
Cane						
Mesh Polo						
<b>SURCHARGES IN € (VAT NOT INCLUDED)</b>						
Antique colour		22,00		22,00		20,00
Pigment colours	37,00	48,00	48,00	48,00	48,00	36,00
Socks						
Foam BS 5852 Crib 5	5,00			5,00	5,00	
Decorative nails						
Reinforcement mesh						
Footrest plate		19,00	19,00	19,00	19,00	
Connection into rows						
Engraving	14,00	14,00	14,00	14,00	14,00	14,00
<b>TECHNICAL INFORMATION</b>						
		high/low	high/low	high/low	high/low	
Total width (cm)	56,5	44/44	44/44	44/44	44/44	46
Total depth (cm)	58,5	53/53	53/53	53/53	53/53	62
Total height (cm)	86	102/90	102/90	102/90	102/90	86
Armrest height (cm)	68,5					
Seat height (cm)	47	73,5/61,5	73,5/61,5	75/63	75/63	46
Width of seat (cm)	48	43/43	43/43	43/43	43/43	46
Depth of seat (cm)	49	43/43	43/43	43/43	43/43	48,5
Weight of product (kg)	7,4	6,6/6,2	6,6/6,2	7,7/7,3	7,7/7,3	5,2
Consumption of fabric (m)	0,341			0,329	0,329	
Consumption of leather (m <sup>2</sup> )	0,990			0,660	0,660	
Packing (pcs)	1	1	1	1	1	2
Volume (m <sup>3</sup> /pc)	0,357	0,332/0,297	0,332/0,297	0,332/0,297	0,332/0,297	0,235
Carton dimensions (cm)	59 × 59 × 89	56 × 48 × 107/ 56 × 48 × 96	56 × 48 × 107/ 56 × 48 × 96	56 × 48 × 107/ 56 × 48 × 96	56 × 48 × 107/ 56 × 48 × 96	72 × 55 × 103
Bicolour						
Stackability						4
Embossed seat/backrest						

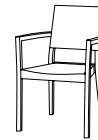

PRODUCT NUMBER	311 516	313 516	313 516	321 516	321 516	323 516
Type	chair	chair	chair	armchair	armchair	armchair
Seat option	veneer	upholstery	upholstery	veneer	veneer	upholstery
Back option						
Type of wood	oak	beech	oak	beech	oak	beech
<b>PRICES IN € (VAT NOT INCLUDED)</b>						
Veneer seat	575,00			467,00	699,00	
Upholstery - category A		358,00	515,00			450,00
Upholstery - category B		365,00	522,00			458,00
Upholstery - category C		371,00	528,00			464,00
Upholstery - category D		385,00	542,00			478,00
Upholstery - category E		419,00	576,00			514,00
Upholstery - category 1		408,00	565,00			513,00
Upholstery - category 2		475,00	632,00			593,00
Upholstery - COM		351,00	508,00			444,00
Cane						
Mesh Polo						
<b>SURCHARGES IN € (VAT NOT INCLUDED)</b>						
Antique colour		20,00		24,00		24,00
Pigment colours	36,00	36,00	36,00	46,00	46,00	46,00
Socks						
Foam BS 5852 Crib 5		5,00	5,00			5,00
Decorative nails						
Reinforcement mesh						
Footrest plate						
Connection into rows						
Engraving	14,00	14,00	14,00	14,00	14,00	14,00
<b>TECHNICAL INFORMATION</b>						
Total width (cm)	46	46	46	56,5	56,5	56,5
Total depth (cm)	62	62	62	58,5	58,5	58,5
Total height (cm)	86	86	86	86	86	86
Armrest height (cm)				68,5	68,5	68,5
Seat height (cm)	46	47	47	46	46	47
Width of seat (cm)	46	46	46	48	48	48
Depth of seat (cm)	48,5	48,5	48,5	49	49	49
Weight of product (kg)	5,2	5,8	5,8	6,6	6,6	7,2
Consumption of fabric (m)		0,341	0,341			0,352
Consumption of leather (m <sup>2</sup> )		0,825	0,825			0,990
Packing (pcs)	2	2	2	1	1	1
Volume (m <sup>3</sup> /pc)	0,235	0,235	0,235	0,357	0,357	0,357
Carton dimensions (cm)	72 × 55 × 103	72 × 55 × 103	72 × 55 × 103	59 × 59 × 89	59 × 59 × 89	59 × 59 × 89
Bicolour						
Stackability	4	4	4	4	4	4
Embossed seat/backrest						

lyon

Tom Kelley

malmö

Michal Riabič

merano →

Alexander Gufler



PRODUCT NUMBER	323 516	311 332	311 332	313 332	313 332	321 400
Type	armchair	chair	chair	chair	chair	armchair
Seat option	upholstery	veneer	veneer	upholstery	upholstery	veneer
Back option		veneer	veneer	upholstery	upholstery	veneer
Type of wood	oak	beech	oak	beech	oak	beech
<b>PRICES IN € (VAT NOT INCLUDED)</b>						
Veneer seat		332,00	489,00			451,00
Upholstery - category A	641,00			532,00	674,00	
Upholstery - category B	649,00			543,00	685,00	
Upholstery - category C	655,00			552,00	694,00	
Upholstery - category D	669,00			573,00	715,00	
Upholstery - category E	705,00			625,00	767,00	
Upholstery - category 1	704,00			612,00	754,00	
Upholstery - category 2	784,00			717,00	859,00	
Upholstery - COM	635,00			522,00	664,00	
Cane						
Mesh Polo						
<b>SURCHARGES IN € (VAT NOT INCLUDED)</b>						
Antique colour		27,00		27,00		28,00
Pigment colours	46,00					142,00
Socks		15,00		15,00		
Foam BS 5852 Crib 5	5,00			9,00	9,00	
Decorative nails						
Reinforcement mesh						
Footrest plate						
Connection into rows						
Engraving	14,00	14,00	14,00	14,00	14,00	14,00
<b>TECHNICAL INFORMATION</b>						
Total width (cm)	56,5	44	44	44	44	54
Total depth (cm)	58,5	47	47	47	47	58
Total height (cm)	86	82	82	82,5	82,5	78
Armrest height (cm)	68,5					66
Seat height (cm)	47	46	46	48	48	45
Width of seat (cm)	48	43	43	43	43	47,5
Depth of seat (cm)	49	39	39	39	39	39
Weight of product (kg)	7,2	5,1	5,1	6,6	6,6	6,5
Consumption of fabric (m)	0,352			0,520	0,520	
Consumption of leather (m²)	0,990			1,301	1,301	
Packing (pcs)	1	2	2	2	2	1
Volume (m³/pc)	0,357	0,153	0,153	0,177	0,177	0,354
Carton dimensions (cm)	59 × 59 × 89	59 × 45 × 100	59 × 45 × 100	64 × 47 × 102	64 × 47 × 102	63 × 58 × 84
Bicolour		✓	✓			
Stackability	4					
Embossed seat/backrest						

2



PRODUCT NUMBER	321 400	321 400	323 400	323 400	323 400	324 400
Type	armchair	armchair	armchair	armchair	armchair	armchair
Seat option	veneer	veneer	upholstery	upholstery	upholstery	upholstery
Back option	veneer	veneer	veneer	veneer	veneer	upholstery
Type of wood	oak	am. walnut	beech	oak	am. walnut	beech
<b>PRICES IN € (VAT NOT INCLUDED)</b>						
Veneer seat	721,00	1 192,00				
Upholstery - category A			527,00	789,00	1 261,00	653,00
Upholstery - category B			534,00	796,00	1 268,00	672,00
Upholstery - category C			539,00	801,00	1 273,00	688,00
Upholstery - category D			550,00	812,00	1 284,00	722,00
Upholstery - category E			579,00	841,00	1 313,00	809,00
Upholstery - category 1			567,00	829,00	1 301,00	784,00
Upholstery - category 2			620,00	882,00	1 354,00	956,00
Upholstery - COM			522,00	784,00	1 256,00	636,00
Cane						
Mesh Polo						
<b>SURCHARGES IN € (VAT NOT INCLUDED)</b>						
Antique colour			28,00			28,00
Pigment colours	62,00		142,00	62,00		142,00
Socks						
Foam BS 5852 Crib 5			5,00	5,00	5,00	14,00
Decorative nails						
Reinforcement mesh						
Footrest plate						
Connection into rows						
Engraving	14,00	14,00	14,00	14,00	14,00	14,00
<b>TECHNICAL INFORMATION</b>						
Total width (cm)	54	54	54	54	54	54
Total depth (cm)	58	58	58	58	58	58
Total height (cm)	78	78	78	78	78	78
Armrest height (cm)	66	66	66	66	66	66
Seat height (cm)	45	45	47	47	47	47
Width of seat (cm)	47,5	47,5	47,5	47,5	47,5	47,5
Depth of seat (cm)	39	39	39	39	39	39
Weight of product (kg)	6,5	6,5	7,3	7,3	7,3	7,8
Consumption of fabric (m)			0,308	0,308	0,308	0,868
Consumption of leather (m <sup>2</sup> )			0,770	0,770	0,770	2,131
Packing (pcs)	1	1	1	1	1	1
Volume (m <sup>3</sup> /pc)	0,354	0,354	0,354	0,354	0,354	0,354
Carton dimensions (cm)	63 × 58 × 84	63 × 58 × 84	63 × 58 × 84	63 × 58 × 84	63 × 58 × 84	63 × 58 × 84
Bicolour						
Stackability						
Embossed seat/backrest						



PRODUCT NUMBER	324 400	324 400	311 401	311 401	311 401	313 401
Type	armchair	armchair	chair	chair	chair	chair
Seat option	upholstery	upholstery	veneer	veneer	veneer	upholstery
Back option	upholstery	upholstery	veneer	veneer	veneer	veneer
Type of wood	oak	am. walnut	beech	oak	am. walnut	beech
<b>PRICES IN € (VAT NOT INCLUDED)</b>						
Veneer seat			362,00	524,00	911,00	
Upholstery - category A	864,00	1 341,00				418,00
Upholstery - category B	883,00	1 360,00				426,00
Upholstery - category C	899,00	1 376,00				431,00
Upholstery - category D	933,00	1 410,00				444,00
Upholstery - category E	1 020,00	1 497,00				476,00
Upholstery - category 1	995,00	1 472,00				468,00
Upholstery - category 2	1 167,00	1 644,00				532,00
Upholstery - COM	847,00	1 324,00				412,00
Cane						
Mesh Polo						
<b>SURCHARGES IN € (VAT NOT INCLUDED)</b>						
Antique colour			18,00			18,00
Pigment colours	62,00		82,00	40,00		82,00
Socks						
Foam BS 5852 Crib 5	14,00	14,00				5,00
Decorative nails						
Reinforcement mesh						
Footrest plate						
Connection into rows			18,00	18,00	18,00	18,00
Engraving	14,00	14,00	14,00	14,00	14,00	14,00
<b>TECHNICAL INFORMATION</b>						
Total width (cm)	54	54	49	49	49	49
Total depth (cm)	58	58	52,5	52,5	52,5	52,5
Total height (cm)	78	78	79	79	79	79
Armrest height (cm)	66	66				
Seat height (cm)	47	47	45	45	45	47
Width of seat (cm)	47,5	47,5	43,6	43,6	43,6	44
Depth of seat (cm)	39	39	42	42	42	42,5
Weight of product (kg)	7,8	7,8	4,6	4,6	4,6	5,4
Consumption of fabric (m)	0,868	0,868				0,320
Consumption of leather (m²)	2,131	2,131				0,799
Packing (pcs)	1	1	2	2	2	2
Volume (m³/pc)	0,354	0,354	0,235	0,235	0,235	0,235
Carton dimensions (cm)	63 × 58 × 84	63 × 58 × 84	72 × 55 × 103	72 × 55 × 103	72 × 55 × 103	72 × 55 × 103
Bicolour						
Stackability			5	5	5	5
Embossed seat/backrest						





PRODUCT NUMBER	313 401	313 401	314 401	314 401	314 401	311 403
Type	chair	chair	chair	chair	chair	barstool
Seat option	upholstery	upholstery	upholstery	upholstery	upholstery	veneer
Back option	veneer	veneer	upholstery	upholstery	upholstery	veneer
Type of wood	oak	am. walnut	beech	oak	am. walnut	beech
<b>PRICES IN € (VAT NOT INCLUDED)</b>						
Veneer seat						435,00
Upholstery - category A	561,00	977,00	546,00	654,00	994,00	
Upholstery - category B	569,00	985,00	562,00	670,00	1 010,00	
Upholstery - category C	574,00	990,00	575,00	683,00	1 023,00	
Upholstery - category D	587,00	1 003,00	605,00	713,00	1 053,00	
Upholstery - category E	619,00	1 035,00	680,00	788,00	1 128,00	
Upholstery - category 1	611,00	1 027,00	658,00	766,00	1 106,00	
Upholstery - category 2	675,00	1 091,00	805,00	913,00	1 253,00	
Upholstery - COM	555,00	971,00	531,00	639,00	979,00	
Cane						
Mesh Polo						
<b>SURCHARGES IN € (VAT NOT INCLUDED)</b>						
Antique colour			18,00			19,00
Pigment colours	40,00		82,00	40,00		93,00
Socks						
Foam BS 5852 Crib 5	5,00	5,00	12,00	12,00	12,00	
Decorative nails						
Reinforcement mesh						
Footrest plate						23,00
Connection into rows	18,00	18,00	18,00	18,00	18,00	
Engraving	14,00	14,00	14,00	14,00	14,00	14,00
<b>TECHNICAL INFORMATION</b>						
						<b>high/low</b>
Total width (cm)	49	49	49	49	49	49/49
Total depth (cm)	52,5	52,5	52,5	52,5	52,5	47,9/47,9
Total height (cm)	79	79	79	79	79	99,4/82,4
Armrest height (cm)						
Seat height (cm)	47	47	47	47	47	78/61
Width of seat (cm)	44	44	44	44	44	44/44
Depth of seat (cm)	42,5	42,5	42,5	42,5	42,5	36/36
Weight of product (kg)	5,4	5,4	5,9	5,9	5,9	5,6/5,1
Consumption of fabric (m)	0,320	0,320	0,747	0,747	0,747	
Consumption of leather (m <sup>2</sup> )	0,799	0,799	1,828	1,828	1,828	
Packing (pcs)	2	2	2	2	2	1
Volume (m <sup>3</sup> /pc)	0,235	0,235	0,235	0,235	0,235	0,318/0,266
Carton dimensions (cm)	72 × 55 × 103	72 × 55 × 103	72 × 55 × 103	72 × 55 × 103	72 × 55 × 103	53 × 50 × 104/ 53 × 50 × 87
Bicolour						
Stackability	5	5	5	5	5	
Embossed seat/backrest						

# merano

Alexander Gufler

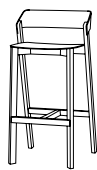
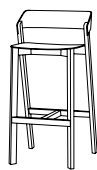

PRODUCT NUMBER	311 403	311 403	313 403	313 403	313 403	314 403
Type	barstool	barstool	barstool	barstool	barstool	barstool
Seat option	veneer	veneer	upholstery	upholstery	upholstery	upholstery
Back option	veneer	veneer	veneer	veneer	veneer	upholstery
Type of wood	oak	am. walnut	beech	oak	am. walnut	beech
<b>PRICES IN € (VAT NOT INCLUDED)</b>						
Veneer seat	630,00	1 179,00				
Upholstery - category A			491,00	654,00	1 248,00	623,00
Upholstery - category B			498,00	661,00	1 255,00	639,00
Upholstery - category C			503,00	666,00	1 260,00	652,00
Upholstery - category D			515,00	678,00	1 272,00	682,00
Upholstery - category E			545,00	708,00	1 302,00	754,00
Upholstery - category 1			537,00	700,00	1 294,00	733,00
Upholstery - category 2			598,00	761,00	1 355,00	876,00
Upholstery - COM			485,00	648,00	1 242,00	610,00
Cane						
Mesh Polo						
<b>SURCHARGES IN € (VAT NOT INCLUDED)</b>						
Antique colour			19,00			19,00
Pigment colours	46,00		93,00	46,00		93,00
Socks						
Foam BS 5852 Crib 5			5,00	5,00	5,00	11,00
Decorative nails						
Reinforcement mesh						
Footrest plate	23,00	23,00	23,00	23,00	23,00	23,00
Connection into rows						
Engraving	14,00	14,00	14,00	14,00	14,00	14,00
<b>TECHNICAL INFORMATION</b>						
	<b>high/low</b>	<b>high/low</b>	<b>high/low</b>	<b>high/low</b>	<b>high/low</b>	<b>high/low</b>
Total width (cm)	49/49	49/49	49/49	49/49	49/49	49/49
Total depth (cm)	47,9/47,9	47,9/47,9	47,9/47,9	47,9/47,9	47,9/47,9	47,9/47,9
Total height (cm)	99,4/82,4	99,4/82,4	99,4/82,4	99,4/82,4	99,4/82,4	99,4/82,4
Armrest height (cm)						
Seat height (cm)	78/61	78/61	80/63	80/63	80/63	80/63
Width of seat (cm)	44/44	44/44	44/44	44/44	44/44	44/44
Depth of seat (cm)	36/36	36/36	36/36	36/36	36/36	36/36
Weight of product (kg)	5,6/5,1	5,6/5,1	6,4/5,9	6,4/5,9	6,4/5,9	6,8/6,3
Consumption of fabric (m)			0,300	0,300	0,300	0,727
Consumption of leather (m²)			0,750	0,750	0,750	1,780
Packing (pcs)	1	1	1	1	1	1
Volume (m³/pc)	0,318/0,266	0,318/0,266	0,318/0,266	0,318/0,266	0,318/0,266	0,318/0,266
Carton dimensions (cm)	53 × 50 × 104/ 53 × 50 × 87	53 × 50 × 104/ 53 × 50 × 87	53 × 50 × 104/ 53 × 50 × 87	53 × 50 × 104/ 53 × 50 × 87	53 × 50 × 104/ 53 × 50 × 87	53 × 50 × 104/ 53 × 50 × 87
Bicolour						
Stackability						
Embossed seat/backrest						

**merano**

Alexander Gufler

**moritz** →

Kai Stania



PRODUCT NUMBER	314 403	314 403	363 404	363 404	363 404	313 623
Type	barstool	barstool	lounge armchair	lounge armchair	lounge armchair	chair
Seat option	upholstery	upholstery	upholstery	upholstery	upholstery	upholstery
Back option	upholstery	upholstery	upholstery	upholstery	upholstery	upholstery
Type of wood	oak	am. walnut	beech	oak	am. walnut	beech
<b>PRICES IN € (VAT NOT INCLUDED)</b>						
Veneer seat						
Upholstery - category A	771,00	1 304,00	786,00	1 040,00	1 492,00	744,00
Upholstery - category B	787,00	1 320,00	829,00	1 083,00	1 535,00	775,00
Upholstery - category C	800,00	1 333,00	864,00	1 118,00	1 570,00	800,00
Upholstery - category D	830,00	1 363,00	942,00	1 196,00	1 648,00	856,00
Upholstery - category E	902,00	1 435,00	1 138,00	1 392,00	1 844,00	998,00
Upholstery - category 1	881,00	1 414,00	1 087,00	1 341,00	1 793,00	961,00
Upholstery - category 2	1 024,00	1 557,00	1 480,00	1 734,00	2 186,00	1 244,00
Upholstery - COM	758,00	1 291,00	749,00	1 003,00	1 455,00	717,00
Cane						
Mesh Polo						
<b>SURCHARGES IN € (VAT NOT INCLUDED)</b>						
Antique colour			19,00			19,00
Pigment colours	46,00		130,00	42,00		33,00
Socks						
Foam BS 5852 Crib 5	11,00	11,00	15,00	15,00	15,00	*
Decorative nails						
Reinforcement mesh						
Footrest plate	23,00	23,00				
Connection into rows						
Engraving	14,00	14,00	14,00	14,00	14,00	
<b>TECHNICAL INFORMATION</b>						
	<b>high/low</b>	<b>high/low</b>				
Total width (cm)	49/49	49/49	56	56	56	46
Total depth (cm)	47,9/47,9	47,9/47,9	65,5	65,5	65,5	60
Total height (cm)	99,4/82,4	99,4/82,4	70	70	70	82,5
Armrest height (cm)			55	55	55	
Seat height (cm)	80/63	80/63	41	41	41	45,5
Width of seat (cm)	44/44	44/44	49	49	49	46
Depth of seat (cm)	36/36	36/36	50	50	50	42
Weight of product (kg)	6,8/6,3	6,8/6,3	9,6	9,6	9,6	8,5
Consumption of fabric (m)	0,727	0,727	1,951	1,951	1,951	1,409
Consumption of leather (m²)	1,780	1,780	4,879	4,879	4,879	3,520
Packing (pcs)	1	1	1	1	1	1
Volume (m³/pc)	0,318/0,266	0,318/0,266	0,358	0,358	0,358	0,320
Carton dimensions (cm)	53 × 50 × 104/ 53 × 50 × 87	53 × 50 × 104/ 53 × 50 × 87	69 × 60 × 75	69 × 60 × 75	69 × 60 × 75	61 × 50 × 91
Bicolour						
Stackability						
Embossed seat/backrest						

\* The price is already inclusive of the surcharge.



PRODUCT NUMBER	313 623	323 623	323 623	363 624	363 624	313 625
Type	chair	armchair	armchair	lounge armchair	lounge armchair	barstool
Seat option	upholstery	upholstery	upholstery	upholstery	upholstery	upholstery
Back option	upholstery	upholstery	upholstery	upholstery	upholstery	upholstery
Type of wood	oak	beech	oak	beech	oak	beech
<b>PRICES IN € (VAT NOT INCLUDED)</b>						
Veneer seat						
Upholstery - category A	892,00	920,00	1 119,00	1 391,00	1 549,00	963,00
Upholstery - category B	923,00	951,00	1 150,00	1 434,00	1 592,00	988,00
Upholstery - category C	948,00	976,00	1 175,00	1 470,00	1 628,00	1 008,00
Upholstery - category D	1 004,00	1 032,00	1 231,00	1 548,00	1 706,00	1 054,00
Upholstery - category E	1 146,00	1 174,00	1 373,00	1 745,00	1 903,00	1 169,00
Upholstery - category 1	1 109,00	1 137,00	1 336,00	1 698,00	1 856,00	1 097,00
Upholstery - category 2	1 392,00	1 420,00	1 619,00	2 096,00	2 254,00	1 283,00
Upholstery - COM	865,00	893,00	1 092,00	1 354,00	1 512,00	941,00
Cane						
Mesh Polo						
<b>SURCHARGES IN € (VAT NOT INCLUDED)</b>						
Antique colour		23,00		21,00		24,00
Pigment colours	33,00	42,00	42,00	37,00	37,00	43,00
Socks						
Foam BS 5852 Crib 5	*	*	*	19,00	19,00	14,00
Decorative nails						
Reinforcement mesh						
Footrest plate						22,00
Connection into rows						
Engraving						
<b>TECHNICAL INFORMATION</b>						
						<b>high/low</b>
Total width (cm)	46	57	57	60	60	43/43
Total depth (cm)	60	60	60	67	67	55/55
Total height (cm)	82,5	82,5	82,5	77	77	102/87
Armrest height (cm)		68	68	62	62	
Seat height (cm)	45,5	45,5	45,5	40	40	80/65
Width of seat (cm)	46	46	46	56	56	43/43
Depth of seat (cm)	42	42	42	47	47	40/40
Weight of product (kg)	8,5	9,7	9,7	13	13	7,2/6,7
Consumption of fabric (m)	1,409	1,409	1,409	1,964	1,964	1,144
Consumption of leather (m²)	3,520	3,520	3,520	4,950	4,950	2,310
Packing (pcs)	1	1	1	1	1	1
Volume (m³/pc)	0,320	0,390	0,390	0,391	0,391	0,327/0,282
Carton dimensions (cm)	61 × 50 × 91	61 × 61 × 91	61 × 61 × 91	66 × 62 × 83	66 × 62 × 83	56 × 47 × 108/ 56 × 47 × 93
Bicolour						
Stackability						
Embossed seat/backrest						

\* The price is already inclusive of the surcharge.

**moritz**

Kai Stania

**petit**

TON R&amp;D

**piano\_505**

TON R&amp;D

**p.o.v.**

kaschkasch



PRODUCT NUMBER	313 625	331 014	371 505	373 505	375 505	371 459
Type	barstool	children's chair	revolving stool	revolving stool	revolving stool	stool
Seat option	upholstery	veneer	veneer	upholstery	cane/mesh Polo	veneer
Back option	upholstery					
Type of wood	oak	beech	beech	beech	beech	beech
<b>PRICES IN € (VAT NOT INCLUDED)</b>						
Veneer seat		245,00	454,00			281,00
Upholstery - category A	1 101,00			475,00		
Upholstery - category B	1 126,00			479,00		
Upholstery - category C	1 146,00			482,00		
Upholstery - category D	1 192,00			489,00		
Upholstery - category E	1 307,00			507,00		
Upholstery - category 1	1 235,00			508,00		
Upholstery - category 2	1 421,00			551,00		
Upholstery - COM	1 079,00			471,00		
Cane					515,00	
Mesh Polo					543,00	
<b>SURCHARGES IN € (VAT NOT INCLUDED)</b>						
Antique colour		17,00	20,00	20,00	20,00	24,00
Pigment colours	43,00	22,00	28,00	28,00	28,00	53,00
Socks						
Foam BS 5852 Crib 5	14,00			5,00		
Decorative nails				29,00		
Reinforcement mesh					28,00	
Footrest plate	22,00					
Connection into rows						
Engraving						
<b>TECHNICAL INFORMATION</b>	<b>high/low</b>					
Total width (cm)	43/43	32	51	51	51	40
Total depth (cm)	55/55	40,5	51	51	51	40
Total height (cm)	102/87	63	43-57	45-59	43-57	45
Armrest height (cm)						
Seat height (cm)	80/65	34	43-57	45-59	43-57	45
Width of seat (cm)	43/43	ø 31	ø 40,5	ø 40,5	ø 40,5	33
Depth of seat (cm)	40/40	ø 31	ø 40,5	ø 40,5	ø 40,5	33
Weight of product (kg)	7,2/6,7	2,1	5,3	5,7	5,3	3,5
Consumption of fabric (m)	1,144			0,182		
Consumption of leather (m <sup>2</sup> )	2,310			0,528		
Packing (pcs)	1	2	1	1	1	1
Volume (m <sup>3</sup> /pc)	0,327/0,282	0,080	0,113	0,113	0,113	0,113
Carton dimensions (cm)	56 × 47 × 108/ 56 × 47 × 93	50 × 38 × 73	43 × 43 × 53	43 × 43 × 53	43 × 43 × 53	43 × 43 × 53
Bicolour						
Stackability						10
Embossed seat/backrest			202, 206, 219, 259			



PRODUCT NUMBER	371 459	371 459	373 459	373 459	373 459	311 391
Type	stool	stool	stool	stool	stool	chair
Seat option	veneer	veneer	upholstery	upholstery	upholstery	veneer
Back option						
Type of wood	oak	am. walnut	beech	oak	am. walnut	beech
<b>PRICES IN € (VAT NOT INCLUDED)</b>						
Veneer seat	356,00	409,00				311,00
Upholstery - category A			359,00	414,00	459,00	
Upholstery - category B			365,00	420,00	465,00	
Upholstery - category C			371,00	426,00	471,00	
Upholstery - category D			382,00	437,00	482,00	
Upholstery - category E			411,00	466,00	511,00	
Upholstery - category 1			390,00	445,00	490,00	
Upholstery - category 2			435,00	490,00	535,00	
Upholstery - COM			354,00	409,00	454,00	
Cane						
Mesh Polo						
<b>SURCHARGES IN € (VAT NOT INCLUDED)</b>						
Antique colour			24,00			15,00
Pigment colours	53,00		53,00	53,00		38,00
Socks						
Foam BS 5852 Crib 5			3,00	3,00	3,00	
Decorative nails						
Reinforcement mesh						
Footrest plate						
Connection into rows						
Engraving						14,00
<b>TECHNICAL INFORMATION</b>						
Total width (cm)	40	40	40	40	40	44,2
Total depth (cm)	40	40	40	40	40	51
Total height (cm)	45	45	46,3	46,3	46,3	79,5
Armrest height (cm)						
Seat height (cm)	45	45	46,3	46,3	46,3	44,9
Width of seat (cm)	33	33	33	33	33	40
Depth of seat (cm)	33	33	33	33	33	40
Weight of product (kg)	3,5	3,5	3,6	3,6	3,6	3,9
Consumption of fabric (m)			0,286	0,286	0,286	
Consumption of leather (m²)			0,550	0,550	0,550	
Packing (pcs)	1	1	1	1	1	2
Volume (m³/pc)	0,113	0,113	0,113	0,113	0,113	0,189
Carton dimensions (cm)	43 × 43 × 53	43 × 43 × 53	43 × 43 × 53	43 × 43 × 53	43 × 43 × 53	66 × 49 × 101
Bicolour						
Stackability	10	10	10	10	10	
Embossed seat/backrest						

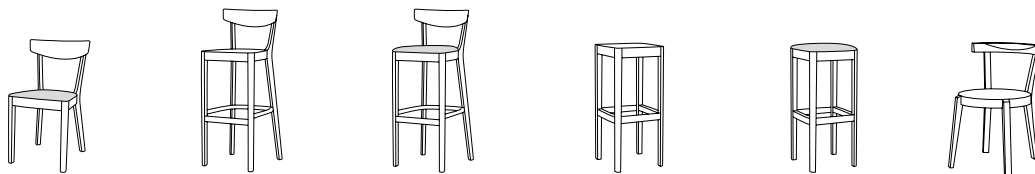

PRODUCT NUMBER	313 391	311 397	313 397	371 398	373 398	311 690
Type	chair	barstool	barstool	barstool	barstool	chair
Seat option	upholstery	veneer	upholstery	veneer	upholstery	veneer
Back option						
Type of wood	beech	beech	beech	beech	beech	beech
<b>PRICES IN € (VAT NOT INCLUDED)</b>						
Veneer seat		<b>362,00</b>		<b>322,00</b>		<b>247,00</b>
Upholstery - category A	<b>322,00</b>		<b>391,00</b>		<b>341,00</b>	
Upholstery - category B	<b>329,00</b>		<b>397,00</b>		<b>345,00</b>	
Upholstery - category C	<b>334,00</b>		<b>402,00</b>		<b>348,00</b>	
Upholstery - category D	<b>346,00</b>		<b>414,00</b>		<b>356,00</b>	
Upholstery - category E	<b>377,00</b>		<b>443,00</b>		<b>374,00</b>	
Upholstery - category 1	<b>362,00</b>		<b>429,00</b>		<b>383,00</b>	
Upholstery - category 2	<b>415,00</b>		<b>480,00</b>		<b>435,00</b>	
Upholstery - COM	<b>317,00</b>		<b>385,00</b>		<b>338,00</b>	
Cane						
Mesh Polo						
<b>SURCHARGES IN € (VAT NOT INCLUDED)</b>						
Antique colour	<b>15,00</b>	<b>19,00</b>	<b>19,00</b>	<b>16,00</b>	<b>16,00</b>	<b>19,00</b>
Pigment colours	<b>38,00</b>	<b>50,00</b>	<b>50,00</b>	<b>40,00</b>	<b>40,00</b>	<b>35,00</b>
Socks						
Foam BS 5852 Crib 5	<b>5,00</b>		<b>5,00</b>		<b>5,00</b>	
Decorative nails						
Reinforcement mesh						
Footrest plate		<b>20,00</b>	<b>20,00</b>	<b>80,00</b>	<b>80,00</b>	
Connection into rows						
Engraving	<b>14,00</b>	<b>14,00</b>	<b>14,00</b>			
<b>TECHNICAL INFORMATION</b>		<b>high/low</b>	<b>high/low</b>	<b>high/low</b>	<b>high/low</b>	
Total width (cm)	44,2	44/44	44/44	36/36	36/36	52
Total depth (cm)	51	46/46	46/46	36/36	36/36	49
Total height (cm)	79,7	107/90	107,2/90,2	80/61	82,5/63,5	75,5
Armrest height (cm)						
Seat height (cm)	47,4	78/61	80,4/63,4	80/61	82,5/63,5	46
Width of seat (cm)	40	39,6/39,6	39,6/39,6	36/36	36/36	ø 40
Depth of seat (cm)	40	37,8/37,8	37,8/37,8	36/36	36/36	ø 40
Weight of product (kg)	4,9	4,8/4,4	5,6/5,2	5/4,3	5,5/4,8	4,4
Consumption of fabric (m)	0,300		0,288		0,185	
Consumption of leather (m <sup>2</sup> )	0,660		0,638		0,528	
Packing (pcs)	2	1	1	1	1	2
Volume (m <sup>3</sup> /pc)	0,189	0,328/0,274	0,328/0,274	0,159/0,159	0,159/0,159	0,204
Carton dimensions (cm)	66 × 49 × 101	52 × 48 × 114/ 48 × 50 × 99	52 × 48 × 114/ 48 × 50 × 99	40 × 40 × 86/ 40 × 40 × 86	40 × 40 × 86/ 40 × 40 × 86	62 × 56 × 102
Bicolour						
Stackability						
Embossed seat/backrest						

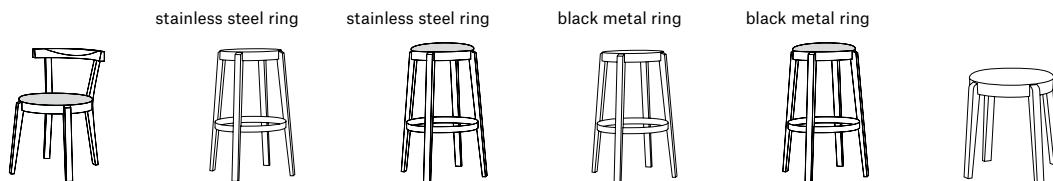

PRODUCT NUMBER	313 690	371 691	373 691	371 691	373 691	371 692
Type	chair	barstool	barstool	barstool	barstool	stool
Seat option	upholstery	veneer	upholstery	veneer	upholstery	veneer
Back option						
Type of wood	beech	beech	beech	beech	beech	beech
<b>PRICES IN € (VAT NOT INCLUDED)</b>						
Veneer seat		433,00		363,00		188,00
Upholstery - category A	282,00		468,00		398,00	
Upholstery - category B	289,00		475,00		405,00	
Upholstery - category C	294,00		480,00		410,00	
Upholstery - category D	306,00		492,00		422,00	
Upholstery - category E	337,00		523,00		453,00	
Upholstery - category 1	322,00		508,00		438,00	
Upholstery - category 2	375,00		561,00		491,00	
Upholstery - COM	277,00		463,00		393,00	
Cane						
Mesh Polo						
<b>SURCHARGES IN € (VAT NOT INCLUDED)</b>						
Antique colour	19,00	21,00	21,00	21,00	21,00	19,00
Pigment colours	35,00	33,00	33,00	33,00	33,00	26,00
Socks						
Foam BS 5852 Crib 5	5,00		5,00		5,00	
Decorative nails						
Reinforcement mesh						
Footrest plate						
Connection into rows						
Engraving						
<b>TECHNICAL INFORMATION</b>						
		high/low	high/low	high/low	high/low	
Total width (cm)	52	58/55	58/55	58/55	58/55	52,5
Total depth (cm)	49	58/55	58/55	58/55	58/55	52,5
Total height (cm)	75,5	80/61	82/63	80/61	82/63	46
Armrest height (cm)						
Seat height (cm)	48	80/61	82/63	80/61	82/63	46
Width of seat (cm)	ø 40	ø 40/ø 40	ø 40/ø 40	ø 40/ø 40	ø 40/ø 40	ø 40
Depth of seat (cm)	ø 40	ø 40/ø 40	ø 40/ø 40	ø 40/ø 40	ø 40/ø 40	ø 40
Weight of product (kg)	5,1	6,9/6,3	7,6/7	6,9/6,3	7,6/7	3,4
Consumption of fabric (m)	0,300		0,300		0,300	
Consumption of leather (m²)	0,660		0,660		0,660	
Packing (pcs)	2	1	1	1	1	1
Volume (m³/pc)	0,204	0,230/0,181	0,230/0,181	0,230/0,181	0,230/0,181	0,113
Carton dimensions (cm)	62 × 56 × 102	48 × 48 × 87/ 48 × 48 × 68	48 × 48 × 87/ 48 × 48 × 68	48 × 48 × 87/ 48 × 48 × 68	48 × 48 × 87/ 48 × 48 × 68	43 × 43 × 53
Bicolour						
Stackability						
Embossed seat/backrest						



**punton**  
Tom Kelley

**rioja**  
Lounge Designgroup

**simple\_705** →  
Olgoj Chorchoj

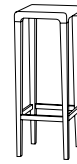
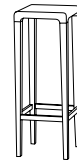
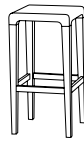

PRODUCT NUMBER	373 692	371 368	371 368	371 369	371 369	311 705
Type	stool	barstool	barstool	barstool	barstool	chair
Seat option	upholstery	solid wood	solid wood	solid wood	solid wood	veneer
Back option						veneer
Type of wood	beech	beech	oak	beech	oak	beech
<b>PRICES IN € (VAT NOT INCLUDED)</b>						
Veneer seat		215,00	291,00	221,00	318,00	314,00
Upholstery - category A	223,00					
Upholstery - category B	230,00					
Upholstery - category C	235,00					
Upholstery - category D	247,00					
Upholstery - category E	278,00					
Upholstery - category 1	263,00					
Upholstery - category 2	316,00					
Upholstery - COM	218,00					
Cane						
Mesh Polo						
<b>SURCHARGES IN € (VAT NOT INCLUDED)</b>						
Antique colour	19,00	16,00		17,00		28,00
Pigment colours	26,00	25,00	25,00	28,00	28,00	71,00
Socks						
Foam BS 5852 Crib 5	5,00					
Decorative nails						
Reinforcement mesh						
Footrest plate		72,00	72,00	72,00	72,00	
Connection into rows						
Engraving						14,00
<b>TECHNICAL INFORMATION</b>						
Total width (cm)	52,5	32	32	32	32	41,5
Total depth (cm)	52,5	32	32	32	32	58,5
Total height (cm)	48	64	64	80	80	85
Armrest height (cm)						
Seat height (cm)	48	64	64	80	80	46
Width of seat (cm)	∅ 40	32	32	32	32	41,5
Depth of seat (cm)	∅ 40	32	32	32	32	39
Weight of product (kg)	4,1	5,4	5,4	5,6	5,6	5,3
Consumption of fabric (m)	0,300					
Consumption of leather (m <sup>2</sup> )	0,660					
Packing (pcs)	1	1	1	1	1	2
Volume (m <sup>3</sup> /pc)	0,113	0,119	0,119	0,145	0,145	0,205
Carton dimensions (cm)	43 × 43 × 53	38 × 38 × 71	38 × 38 × 71	38 × 38 × 87	38 × 38 × 87	67 × 53 × 100
Bicolour						
Stackability						
Embossed seat/backrest						

# simple\_705 split

Olgoj Chorchoj

Arik Levy

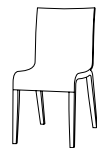

PRODUCT NUMBER	311 705	311 371	311 371	313 371	313 371	311 372
Type	chair	chair	chair	chair	chair	barstool
Seat option	veneer	solid wood	solid wood	upholstery	upholstery	solid wood
Back option	veneer	veneer	veneer	upholstery	upholstery	veneer
Type of wood	oak	beech	ash	beech	ash	beech
<b>PRICES IN € (VAT NOT INCLUDED)</b>						
Veneer seat	423,00	753,00	858,00			884,00
Upholstery - category A				922,00	1 027,00	
Upholstery - category B				934,00	1 039,00	
Upholstery - category C				943,00	1 048,00	
Upholstery - category D				964,00	1 069,00	
Upholstery - category E				1 017,00	1 122,00	
Upholstery - category 1				1 004,00	1 109,00	
Upholstery - category 2				1 110,00	1 215,00	
Upholstery - COM				912,00	1 017,00	
Cane						
Mesh Polo						
<b>SURCHARGES IN € (VAT NOT INCLUDED)</b>						
Antique colour		21,00		21,00		50,00
Pigment colours	45,00	70,00	41,00	70,00	41,00	92,00
Socks						
Foam BS 5852 Crib 5				9,00	9,00	
Decorative nails						
Reinforcement mesh						
Footrest plate						
Connection into rows						
Engraving	14,00	14,00	14,00	14,00	14,00	14,00
<b>TECHNICAL INFORMATION</b>						
						<b>high/low</b>
Total width (cm)	41,5	52	52	52	52	45,4/45,4
Total depth (cm)	58,5	56	56	58,5	58,5	50,4/46,3
Total height (cm)	85	78	78	80	80	98/81
Armrest height (cm)						
Seat height (cm)	46	46	46	48	48	78/61
Width of seat (cm)	41,5	46,7	46,7	46,7	46,7	42,1/42,1
Depth of seat (cm)	39	46,6	46,6	46,6	46,6	39,2/39,2
Weight of product (kg)	5,3	6,3	6,3	7,5	7,5	6,5/5,5
Consumption of fabric (m)				0,529	0,529	
Consumption of leather (m²)				1,323	1,323	
Packing (pcs)	2	1	1	1	1	1
Volume (m³/pc)	0,205	0,322	0,322	0,322	0,322	0,302/0,233
Carton dimensions (cm)	67 × 53 × 100	61 × 54 × 85	61 × 54 × 85	61 × 54 × 85	61 × 54 × 85	54 × 48 × 101/ 50 × 48 × 84
Bicolour						
Stackability						
Embossed seat/backrest						

# split

Arik Levy

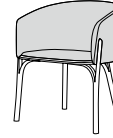

PRODUCT NUMBER	311 372	313 372	313 372	323 373	323 373	363 374
Type	barstool	barstool	barstool	armchair	armchair	lounge armchair
Seat option	solid wood	upholstery	upholstery	upholstery	upholstery	upholstery
Back option	veneer	upholstery	upholstery	upholstery	upholstery	upholstery
Type of wood	ash	beech	ash	beech	ash	beech
<b>PRICES IN € (VAT NOT INCLUDED)</b>						
Veneer seat	<b>1 024,00</b>					
Upholstery - category A		<b>1 035,00</b>	<b>1 175,00</b>	<b>1 411,00</b>	<b>1 486,00</b>	<b>1 431,00</b>
Upholstery - category B		<b>1 046,00</b>	<b>1 186,00</b>	<b>1 449,00</b>	<b>1 524,00</b>	<b>1 486,00</b>
Upholstery - category C		<b>1 054,00</b>	<b>1 194,00</b>	<b>1 480,00</b>	<b>1 555,00</b>	<b>1 530,00</b>
Upholstery - category D		<b>1 073,00</b>	<b>1 213,00</b>	<b>1 549,00</b>	<b>1 624,00</b>	<b>1 629,00</b>
Upholstery - category E		<b>1 120,00</b>	<b>1 260,00</b>	<b>1 723,00</b>	<b>1 798,00</b>	<b>1 877,00</b>
Upholstery - category 1		<b>1 108,00</b>	<b>1 248,00</b>	<b>1 678,00</b>	<b>1 753,00</b>	<b>1 813,00</b>
Upholstery - category 2		<b>1 202,00</b>	<b>1 342,00</b>	<b>2 027,00</b>	<b>2 102,00</b>	<b>2 311,00</b>
Upholstery - COM		<b>1 027,00</b>	<b>1 167,00</b>	<b>1 378,00</b>	<b>1 453,00</b>	<b>1 384,00</b>
Cane						
Mesh Polo						
<b>SURCHARGES IN € (VAT NOT INCLUDED)</b>						
Antique colour		<b>50,00</b>		<b>17,00</b>		<b>11,00</b>
Pigment colours	<b>44,00</b>	<b>92,00</b>	<b>44,00</b>	<b>32,00</b>	<b>23,00</b>	<b>16,00</b>
Socks						
Foam BS 5852 Crib 5		<b>9,00</b>	<b>9,00</b>	<b>21,00</b>	<b>21,00</b>	<b>53,00</b>
Decorative nails						
Reinforcement mesh						
Footrest plate						
Connection into rows						
Engraving	<b>14,00</b>	<b>14,00</b>	<b>14,00</b>			
<b>TECHNICAL INFORMATION</b>						
	<b>high/low</b>	<b>high/low</b>	<b>high/low</b>			
Total width (cm)	45,4/45,4	45,4/45,4	45,4/45,4	62	62	62
Total depth (cm)	50,4/46,3	51/47	51/47	63	63	71
Total height (cm)	98/81	100/83	100/83	78	78	72,5
Armrest height (cm)				67,5	67,5	61
Seat height (cm)	78/61	80/63	80/63	48	48	42
Width of seat (cm)	42,1/42,1	42,1/42,1	42,1/42,1	47	47	47
Depth of seat (cm)	39,2/39,2	39,2/39,2	39,2/39,2	47	47	49
Weight of product (kg)	6,5/5,5	7,5/6,5	7,5/6,5	12,5	12,5	12,8
Consumption of fabric (m)		0,468	0,468	1,733	1,733	2,472
Consumption of leather (m <sup>2</sup> )		1,169	1,169	4,332	4,332	6,179
Packing (pcs)	1	1	1	1	1	1
Volume (m <sup>3</sup> /pc)	0,302/0,233	0,311/0,241	0,311/0,241	0,414	0,414	0,433
Carton dimensions (cm)	54 × 48 × 101/ 50 × 48 × 84	54 × 48 × 104/ 50 × 48 × 87	54 × 48 × 104/ 50 × 48 × 87	67 × 64 × 84	67 × 64 × 84	74 × 66 × 77
Bicolour						
Stackability						
Embossed seat/backrest						

split

Arik Levy

stockholm

Mads K. Johansen



PRODUCT NUMBER	363 374	311 700	311 700	313 700	313 700	321 700
Type	lounge armchair	chair	chair	chair	chair	armchair
Seat option	upholstery	veneer	veneer	upholstery	upholstery	veneer
Back option	upholstery	veneer	veneer	upholstery	upholstery	veneer
Type of wood	ash	beech	oak	beech	oak	beech
<b>PRICES IN € (VAT NOT INCLUDED)</b>						
Veneer seat		296,00	442,00			414,00
Upholstery - category A	1 494,00			486,00	594,00	
Upholstery - category B	1 549,00			498,00	606,00	
Upholstery - category C	1 593,00			507,00	615,00	
Upholstery - category D	1 692,00			528,00	636,00	
Upholstery - category E	1 940,00			580,00	688,00	
Upholstery - category 1	1 876,00			567,00	675,00	
Upholstery - category 2	2 374,00			671,00	779,00	
Upholstery - COM	1 447,00			476,00	584,00	
Cane						
Mesh Polo						
<b>SURCHARGES IN € (VAT NOT INCLUDED)</b>						
Antique colour		29,00		29,00		34,00
Pigment colours	16,00		41,00		41,00	
Socks						
Foam BS 5852 Crib 5	53,00			9,00	9,00	
Decorative nails						
Reinforcement mesh						
Footrest plate						
Connection into rows						
Engraving		14,00	14,00	14,00	14,00	14,00
<b>TECHNICAL INFORMATION</b>						
Total width (cm)	62	49,5	49,5	49,5	49,5	62
Total depth (cm)	71	52,5	52,5	52,5	52,5	52,5
Total height (cm)	72,5	83	83	83,5	83,5	83
Armrest height (cm)	61					70
Seat height (cm)	42	47	47	49	49	47
Width of seat (cm)	47	40,5	40,5	40,5	40,5	40,5
Depth of seat (cm)	49	38	38	38	38	38
Weight of product (kg)	12,8	5,2	5,2	6,9	6,9	6,1
Consumption of fabric (m)	2,472			0,520	0,520	
Consumption of leather (m <sup>2</sup> )	6,179			1,312	1,312	
Packing (pcs)	1	2	2	2	2	1
Volume (m <sup>3</sup> /pc)	0,433	0,215	0,215	0,215	0,215	0,393
Carton dimensions (cm)	74 × 66 × 77	67 × 53 × 105	67 × 53 × 105	67 × 53 × 105	67 × 53 × 105	65 × 59 × 89
Bicolour		✓	✓			✓
Stackability		5	5	5	5	
Embossed seat/backrest						

2

stockholm

Mads K. Johansen

treviso →

Tom Kelley



PRODUCT NUMBER	323 700	371 701	371 701	373 701	373 701	313 713
Type	armchair	barstool	barstool	barstool	barstool	chair
Seat option	upholstery	veneer	veneer	upholstery	upholstery	upholstery
Back option	upholstery					upholstery
Type of wood	beech	beech	oak	beech	oak	beech
<b>PRICES IN € (VAT NOT INCLUDED)</b>						
Veneer seat		308,00	430,00			
Upholstery - category A	604,00			373,00	476,00	302,00
Upholstery - category B	616,00			379,00	482,00	319,00
Upholstery - category C	625,00			384,00	487,00	333,00
Upholstery - category D	646,00			396,00	499,00	365,00
Upholstery - category E	698,00			425,00	528,00	444,00
Upholstery - category 1	685,00			404,00	507,00	420,00
Upholstery - category 2	789,00			448,00	551,00	575,00
Upholstery - COM	594,00			367,00	470,00	287,00
Cane						
Mesh Polo						
<b>SURCHARGES IN € (VAT NOT INCLUDED)</b>						
Antique colour	34,00	30,00		30,00		17,00
Pigment colours			41,00		41,00	22,00
Socks						
Foam BS 5852 Crib 5	9,00			5,00	5,00	9,00
Decorative nails						
Reinforcement mesh						
Footrest plate		36,00	36,00	36,00	36,00	
Connection into rows						
Engraving	14,00					
<b>TECHNICAL INFORMATION</b>						
		high/low	high/low	high/low	high/low	
Total width (cm)	62	44/43	44/43	44/43	44/43	46
Total depth (cm)	52,5	41/38	41/38	41/38	41/38	53,5
Total height (cm)	83,5	79/61	79/61	81/63	81/63	82
Armrest height (cm)	70					
Seat height (cm)	49	79/61	79/61	81/63	81/63	47
Width of seat (cm)	40,5	40/40	40/40	40/40	40/40	42
Depth of seat (cm)	38	40/40	40/40	40/40	40/40	44
Weight of product (kg)	7,7	4,8/4,3	4,8/4,3	5,8/5,3	5,8/5,3	6,1
Consumption of fabric (m)	0,520			0,289	0,289	0,788
Consumption of leather (m²)	1,312			0,550	0,550	1,925
Packing (pcs)	1	1	1	1	1	2
Volume (m³/pc)	0,393	0,224/0,224	0,224/0,224	0,224/0,224	0,224/0,224	0,235
Carton dimensions (cm)	65 × 59 × 89	47 × 47 × 88/ 47 × 47 × 88	47 × 47 × 88/ 47 × 47 × 88	47 × 47 × 88/ 47 × 47 × 88	47 × 47 × 88/ 47 × 47 × 88	72 × 55 × 103
Bicolour		√	√			
Stackability						4
Embossed seat/backrest						

treviso

Tom Kelley

valencia

Yonoh



PRODUCT NUMBER	323 713	311 382	311 382	313 382	313 382	314 382
Type	armchair	chair	chair	chair	chair	chair
Seat option	upholstery	veneer	veneer	upholstery	upholstery	upholstery
Back option	upholstery	veneer	veneer	veneer	veneer	upholstery
Type of wood	beech	beech	oak	beech	oak	beech
<b>PRICES IN € (VAT NOT INCLUDED)</b>						
Veneer seat		384,00	553,00			
Upholstery - category A	382,00			447,00	570,00	510,00
Upholstery - category B	399,00			459,00	582,00	528,00
Upholstery - category C	413,00			469,00	592,00	542,00
Upholstery - category D	445,00			491,00	614,00	575,00
Upholstery - category E	524,00			547,00	670,00	657,00
Upholstery - category 1	500,00			533,00	656,00	636,00
Upholstery - category 2	655,00			644,00	767,00	799,00
Upholstery - COM	367,00			437,00	560,00	494,00
Cane						
Mesh Polo						
<b>SURCHARGES IN € (VAT NOT INCLUDED)</b>						
Antique colour	19,00	20,00		20,00		20,00
Pigment colours	25,00	47,00	47,00	47,00	47,00	47,00
Socks						
Foam BS 5852 Crib 5	9,00			6,00	6,00	9,00
Decorative nails						
Reinforcement mesh						
Footrest plate						
Connection into rows						
Engraving		14,00	14,00	14,00	14,00	14,00
<b>TECHNICAL INFORMATION</b>						
Total width (cm)	57	51	51	51	51	51
Total depth (cm)	53,5	54,5	54,5	55	55	55
Total height (cm)	82	81	81	81	81	81
Armrest height (cm)	66					
Seat height (cm)	47	45	45	47,5	47,5	47,5
Width of seat (cm)	41,6	43	43	44,5	44,5	44,5
Depth of seat (cm)	44	47	47	48,5	48,5	48,5
Weight of product (kg)	7,5	5	5	5,3	5,3	6,2
Consumption of fabric (m)	0,788			0,554	0,554	0,814
Consumption of leather (m²)	1,925			1,386	1,386	2,035
Packing (pcs)	1	2	2	2	2	2
Volume (m³/pc)	0,350	0,235	0,235	0,235	0,235	0,235
Carton dimensions (cm)	60 × 57 × 89	72 × 55 × 103	72 × 55 × 103	72 × 55 × 103	72 × 55 × 103	72 × 55 × 103
Bicolour						
Stackability	4	4	4	4	4	4
Embossed seat/backrest						

2

# valencia

Yonoh

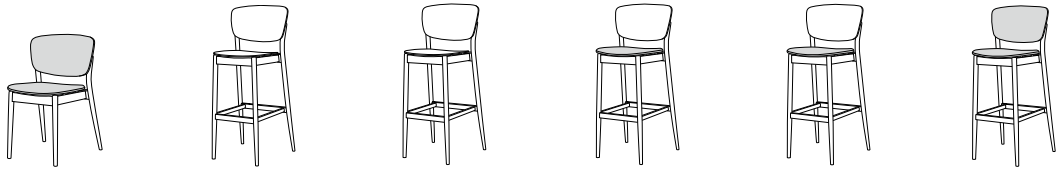

PRODUCT NUMBER	314 382	311 383	311 383	313 383	313 383	314 383
Type	chair	barstool	barstool	barstool	barstool	barstool
Seat option	upholstery	veneer	veneer	upholstery	upholstery	upholstery
Back option	upholstery	veneer	veneer	veneer	veneer	upholstery
Type of wood	oak	beech	oak	beech	oak	beech
<b>PRICES IN € (VAT NOT INCLUDED)</b>						
Veneer seat		445,00	649,00			
Upholstery - category A	605,00			512,00	672,00	571,00
Upholstery - category B	623,00			524,00	684,00	589,00
Upholstery - category C	637,00			534,00	694,00	603,00
Upholstery - category D	670,00			556,00	716,00	636,00
Upholstery - category E	752,00			612,00	772,00	718,00
Upholstery - category 1	731,00			598,00	758,00	697,00
Upholstery - category 2	894,00			709,00	869,00	860,00
Upholstery - COM	589,00			502,00	662,00	555,00
Cane						
Mesh Polo						
<b>SURCHARGES IN € (VAT NOT INCLUDED)</b>						
Antique colour		23,00		23,00		23,00
Pigment colours	47,00	57,00	57,00	57,00	57,00	57,00
Socks						
Foam BS 5852 Crib 5	9,00			6,00	6,00	9,00
Decorative nails						
Reinforcement mesh						
Footrest plate		19,00	19,00	19,00	19,00	19,00
Connection into rows						
Engraving	14,00	14,00	14,00	14,00	14,00	14,00
<b>TECHNICAL INFORMATION</b>						
		high/low	high/low	high/low	high/low	high/low
Total width (cm)	51	51/51	51/51	51/51	51/51	51/51
Total depth (cm)	55	53/52	53/52	53,5/52,5	53,5/52,5	53,5/52,5
Total height (cm)	81	116,5/97,5	116,5/97,5	116,5/97,5	116,5/97,5	116,5/97,5
Armrest height (cm)						
Seat height (cm)	47,5	80/61	80/61	82,5/63,5	82,5/63,5	82,5/63,5
Width of seat (cm)	44,5	43	43	44,5	44,5	44,5
Depth of seat (cm)	48,5	45	45	46,5	46,5	46,5
Weight of product (kg)	6,2	6,6/6,2	6,6/6,2	6,9/6,5	6,9/6,5	7,8/7,4
Consumption of fabric (m)	0,814			0,554	0,554	0,814
Consumption of leather (m²)	2,035			1,386	1,386	2,035
Packing (pcs)	2	1	1	1	1	1
Volume (m³/pc)	0,235	0,428/0,355	0,428/0,355	0,428/0,355	0,428/0,355	0,428/0,355
Carton dimensions (cm)	72 × 55 × 103	57 × 54 × 121/ 56 × 54 × 102	57 × 54 × 121/ 56 × 54 × 102	57 × 54 × 121/ 56 × 54 × 102	57 × 54 × 121/ 56 × 54 × 102	57 × 54 × 121/ 56 × 54 × 102
Bicolour						
Stackability	4					
Embossed seat/backrest						







# valencia

Yonoh



<b>PRODUCT NUMBER</b>	<b>314 383</b>
Type	barstool
Seat option	upholstery
Back option	upholstery
Type of wood	oak
<b>PRICES IN € (VAT NOT INCLUDED)</b>	
Veneer seat	
Upholstery - category A	<b>704,00</b>
Upholstery - category B	<b>722,00</b>
Upholstery - category C	<b>736,00</b>
Upholstery - category D	<b>769,00</b>
Upholstery - category E	<b>851,00</b>
Upholstery - category 1	<b>830,00</b>
Upholstery - category 2	<b>993,00</b>
Upholstery - COM	<b>688,00</b>
Cane	
Mesh Polo	
<b>SURCHARGES IN € (VAT NOT INCLUDED)</b>	
Antique colour	
Pigment colours	<b>57,00</b>
Socks	
Foam BS 5852 Crib 5	<b>9,00</b>
Decorative nails	
Reinforcement mesh	
Footrest plate	<b>19,00</b>
Connection into rows	
Engraving	<b>14,00</b>
<b>TECHNICAL INFORMATION</b>	
	<b>high/low</b>
Total width (cm)	51/51
Total depth (cm)	53,5/52,5
Total height (cm)	116,5/97,5
Armrest height (cm)	
Seat height (cm)	82,5/63,5
Width of seat (cm)	44,5
Depth of seat (cm)	46,5
Weight of product (kg)	7,8/7,4
Consumption of fabric (m)	0,814
Consumption of leather (m²)	2,035
Packing (pcs)	1
Volume (m³/pc)	0,428/0,355
Carton dimensions (cm)	57 × 54 × 121/ 56 × 54 × 102
Bicolour	
Stackability	
Embossed seat/backrest	



	<b>fleur</b> Lubo Majer	<b>logs</b> Büro Famos		<b>petalo</b> Eugenia Minerva		<b>stand by</b> TON R&D	
							
<b>PRODUCT NUMBER</b>	<b>711 103</b>	<b>712 107</b>		<b>712 107</b>	<b>711 100</b>	<b>711 015</b>	<b>711 020</b>
Type	coat stand	coat hook		coat hook	coat stand	coat stand	coat stand
Type of wood	beech	beech		oak	beech	beech	beech
<b>PRICES IN € (VAT NOT INCLUDED)</b>	<b>513,00</b>	<b>50,00</b>		<b>75,00</b>	<b>657,00</b>	<b>595,00</b>	<b>339,00</b>
<b>SURCHARGES IN € (VAT NOT INCLUDED)</b>							
Antique colour	<b>18,00</b>	<b>5,00</b>			<b>21,00</b>	<b>25,00</b>	<b>24,00</b>
Pigment colours	<b>26,00</b>	<b>11,00</b>		<b>11,00</b>	<b>32,00</b>	<b>37,00</b>	<b>28,00</b>
<b>TECHNICAL INFORMATION</b>							
Total width (cm)	57	22,2		22,2	58	59	60
Total depth (cm)	57	9,5		9,5	53	59	60
Total height (cm)	178	25		25	108	190	190
Armrest height (cm)							
Seat height (cm)							
Width of seat (cm)							
Depth of seat (cm)							
Weight of product (kg)	3,6	0,3		0,3	3	5	3,5
Consumption of fabric (m)							
Consumption of leather (m <sup>2</sup> )							
Packing (pcs)	1	1		1	1	1	1
Volume (m <sup>3</sup> /pc)	0,689	0,011		0,011	0,452	0,479	0,371
Carton dimensions (cm)	60 × 54 × 185	25 × 29 × 13		25 × 29 × 13	60 × 56 × 117	154 × 52 × 52	152 × 46 × 46
Bicolour					√		
Stackability							

## tee

Jan Padmos

## hoop

Olgoj Chorchoj

## ripple

Tablo

merano  
link

Alexander Gufler

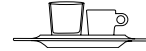
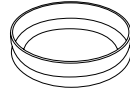

PRODUCT NUMBER	711 104	309 264	309 280	309 282	309 284	309 279
Type	coat stand	bowl	tray, 2 pcs	espresso set	cappuccino set	side cover

Type of wood	oak	ash	oak	oak	oak	
--------------	-----	-----	-----	-----	-----	--

PRICES IN €  
(VAT NOT INCLUDED)

	303,00	296,00	117,00	116,00	117,00	28,00
--	--------	--------	--------	--------	--------	-------

SURCHARGES IN €  
(VAT NOT INCLUDED)

Antique colour						
----------------	--	--	--	--	--	--

Pigment colours						
-----------------	--	--	--	--	--	--

TECHNICAL  
INFORMATION

Total width (cm)	24	ø 33				6,8
------------------	----	------	--	--	--	-----

Total depth (cm)	24	ø 33				3,7
------------------	----	------	--	--	--	-----

Total height (cm)	170	8				1,3
-------------------	-----	---	--	--	--	-----

Armrest height (cm)						
---------------------	--	--	--	--	--	--

Seat height (cm)						
------------------	--	--	--	--	--	--

Width of seat (cm)						
--------------------	--	--	--	--	--	--

Depth of seat (cm)						
--------------------	--	--	--	--	--	--

Weight of product (kg)	12,5	3,3	0,5	0,43	0,53	0,03
------------------------	------	-----	-----	------	------	------

Consumption of fabric (m)						
---------------------------	--	--	--	--	--	--

Consumption of leather (m²)						
-----------------------------	--	--	--	--	--	--

Packing (pcs)	1	1	1	1	1	
---------------	---	---	---	---	---	--

Volume (m³/pc)	0,045	0,015	0,006	0,006	0,006	
----------------	-------	-------	-------	-------	-------	--

Carton dimensions (cm)	174 × 6,5 × 6,5	35 × 34,7 × 10,8	21,5 × 21 × 11,5	21,5 × 21 × 11,5	21,5 × 21 × 11,5	
------------------------	-----------------	------------------	------------------	------------------	------------------	--

	34 × 34 × 27					
--	--------------	--	--	--	--	--

Bicolour						
----------	--	--	--	--	--	--

Stackability						
--------------	--	--	--	--	--	--

**merano  
trolley**

Alexander Gufler



**p.o.v. stool  
trolley**

kaschkasch



**stacking  
interlay  
valencia**

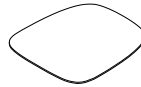

**stacking  
interlay  
merano**

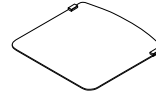

**stacking  
interlay  
lyon**

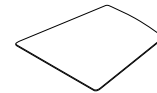

**stacking  
interlay  
stockholm**

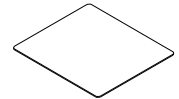

PRODUCT NUMBER	799 405	799 458	309 370	309 371	309 372	309 373
Type	trolley	trolley	stacking interlay	stacking interlay	stacking interlay	stacking interlay

Type of wood	beech	beech				
--------------	-------	-------	--	--	--	--

PRICES IN € (VAT NOT INCLUDED)	719,00	147,00	11,00	13,00	11,00	9,00
-----------------------------------	--------	--------	-------	-------	-------	------

**SURCHARGES IN €  
(VAT NOT INCLUDED)**

Antique colour						
Pigment colours						

**TECHNICAL  
INFORMATION**

Total width (cm)	55,5	40	43	44,2	44	40,2
Total depth (cm)	84	40	47,3	43	44,6	36
Total height (cm)	70,5	8,5	0,3	1,1	0,3	0,3
Armrest height (cm)						
Seat height (cm)						
Width of seat (cm)						
Depth of seat (cm)						
Weight of product (kg)	16	3,3	0,5	0,5	0,5	0,4
Consumption of fabric (m)						
Consumption of leather (m <sup>2</sup> )						
Packing (pcs)	1	1	10	6	10	10
Volume (m <sup>3</sup> /pc)	0,448	0,038	0,002	0,003	0,002	0,002
Carton dimensions (cm)	85 × 61 × 75	43 × 43 × 18	59 × 51 × 7	48 × 48 × 7	48 × 48 × 7	48 × 48 × 7

Bicolour						
Stackability						

stacking  
interlay  
bergamo, treviso

carebox

carekit  
elmo

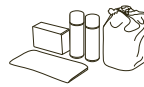
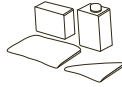
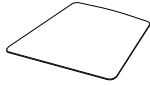

PRODUCT NUMBER	309 374	CB0 004	CB0 002
Type	stacking interlay	carebox	leather carekit

Type of wood

PRICES IN €  
(VAT NOT INCLUDED)

	10,00	31,00	45,00
--	-------	-------	-------

SURCHARGES IN €  
(VAT NOT INCLUDED)

Antique colour

Pigment colours

TECHNICAL  
INFORMATION

Total width (cm)	42		
Total depth (cm)	41,3		
Total height (cm)	0,3		
Armrest height (cm)			
Seat height (cm)			
Width of seat (cm)			
Depth of seat (cm)			
Weight of product (kg)	0,4	0,33	0,4
Consumption of fabric (m)			
Consumption of leather (m <sup>2</sup> )			
Packing (pcs)	10	1	1
Volume (m <sup>3</sup> /pc)	0,002	0,003	0,003
Carton dimensions (cm)	48 × 48 × 7	18 × 11 × 12	13 × 13 × 16

Bicolour

Stackability



**tables,  
table tops  
and bases**

# tables

Our collection contains tables made from a solid wood structure with a solid wood table top, but also tables with legs made of extruded plywood. You can also choose another table top material for certain table types. The table top type

is specified under the respective product number and the relevant letter (such as **M** = solid wood). We also offer combinations of separate table top and metal central bases.

! The shapes of the edges and the corners are given by the construction method and cannot be changed.

! Click on this [link](#) for detailed photographs.

## Colours and surface finishes of tables and separate table top

The information provided in the chapter "Wood, colours, surface finishes" on colours

and surface finishes applies to tables and table top as well.

! Solid wood tables and table tops cannot be finished with pigments from the Pantone, RAL and NCS colour charts. YYY coffee tables are the only exception; these can be finished in pigments.

## Table top materials

### B - multiplex top

The table top is made of plywood from beech veneers, veneered from both sides. The top and underside of the table top are also covered with a beech veneer.

### D - veneered top + veneered edge

### N - veneered top + solid wood edge

The basic material is multiplex board which is veneered with cut ornamental beech or oak on the upper side (letter D). Another option is a solid wood edge from beech or oak (letter N).

### F - veneered MDF top

The basic material is MDF board veneered with beech veneer from both sides.

### M - solid wood top

The solid wood table top comprises lengths of wood that have been glued together. Attention must be paid to colour differences where there is a large edge-glued panel, because the individually affixed squared logs come from different parts of the trunk. In addition, a dimensional tolerance deviation of 3–5 mm is set for solid table tops (depending on the width of the table), because wood, a natural material, responds to its surrounding environment. Such natural reactions may include spontaneous sagging, which is why table tops with dimensions larger than 50 cm are supplied with bracing on the underside as standard.

### M - solid wood top Rustic

The rustic version of the solid oak wood table top is made from lengths of wood that show a more pronounced wood structure and visible knars and other small irregularities. These in no way lessen the quality of the material used.

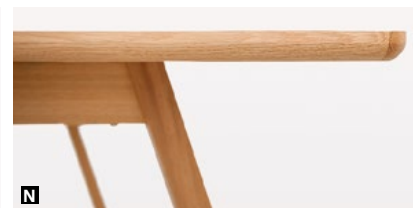

Solid wood rustic

! Please note that due to natural origin of the table top material, the top layers can absorb the finishing materials differently (applies to letters B, D, F, M, N, U).

! The rustic finish can only be applied to the table top. The table legs or pedestal have the standard finish.

### U - multiplex top+veneered surface

The basic material is multiplex board which is veneered with cut ornamental beech or oak on the upper side. The multiplex consists of veneer layers applied crosswise, glued and pressed similarly to plywood. It is characterized by higher thickness of the inner veneers, so the properties of the pressed boards approach solid wood. Depending on the shape of the edges, the veneers can also be pressed to the edge or its part. Otherwise, characteristic layers of the pressed veneers are visible on the edge.



## Glides and wheels

Dark felt glides are enclosed to the tables for the customer to attach them to the table as needed. The extendable tables have small inbuilt wheels at the end of legs, which make easier handling of

the tables when being extended. The wheels are installed only on the side of the table that moves during extension.

! Note that glides cannot be used for the Ironica and Leaf tables because the leg ends are rounded.

! The wheels are not used for transporting the table (either in a folded or extended state).



## Assembly of tables and handling

Please follow the simple icons used in the Assembly instructions or marked on the packaging. The figure defines the recommended number of people needed to assemble the table or to handle it safely.





---

## Table top grain

Individual lines display direction of wood grain on a table top.

### ■ Solid wood table tops

#### Fixed table

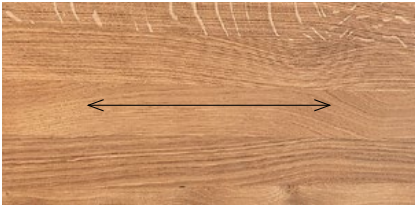

#### Extended table



#### Table Chop fixed



#### Table Chop extended



#### Rustic table top (fixed table)



## Linking tables

Some of the tables in our range can be connected into rows using simple fittings, thus creating a line of tables or other shapes necessary for ceremonial events or conference premises. Tables suitable for linking are selected with regard to the design of the table, thickness of the table top and shape of the edges so that their connection is stable. Linking tables together can also eliminate minor height unevenness of the floor. The connecting hardware has two parts, which are always located on one side of the table (see

the drawing). In this way, it is possible to achieve a universal connection of various tables of the same size. The connecting fittings are fixed to the bottom of the table top and after being folded do not disrupt the appearance of the table (see the illustration photo). The surcharge in the price list is always listed for one connecting set.

The drawing shows the most common variants of linking tables, which are marked as options A, B and C. Simply state the variant you have chosen in the order.



Connection



Disconnection

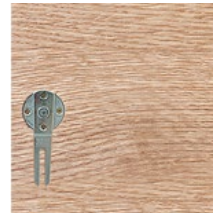

Configuration of connecting hardware on table top

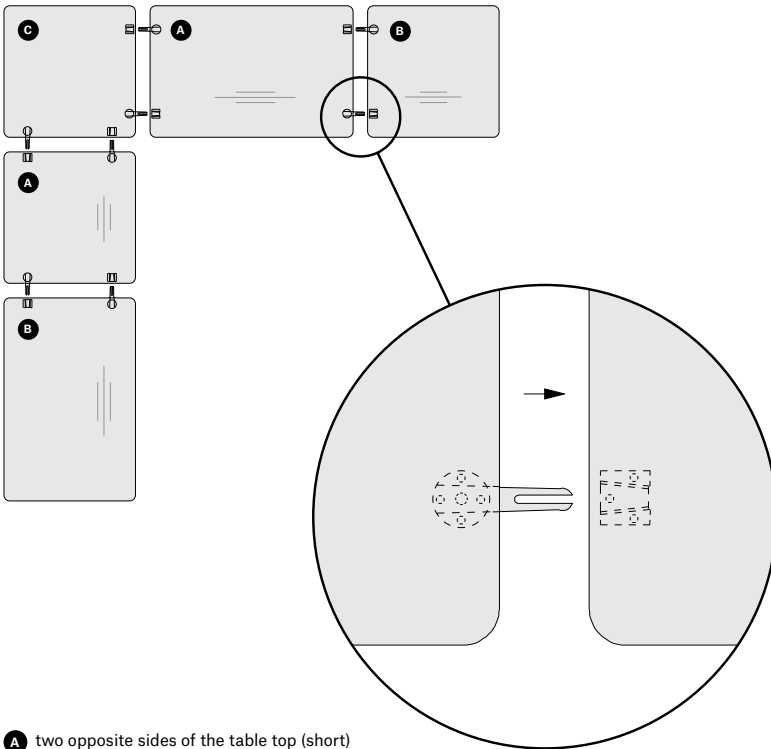

- A** two opposite sides of the table top (short)
- B** one side of the table top (short)
- C** two adjoining sides of the table top (across the corner)

**!** The lines in the drawing show the direction of the fibres on the table top.

## Extendable tables



Chop 446



Jylland 476



Stockholm 700



! Do not overload the extended table at the point of connection of the table top. Do not sit, stand on the tables, etc.

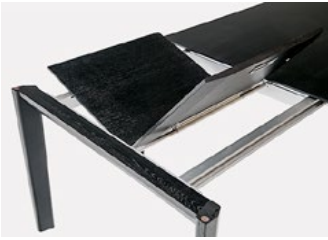

Trapez 708

## Stackability

Only a few tables with solid wooden structures can be stacked if necessary. For this purpose, we offer the Lasu table from our range. The tables have recessed felt pads on the bottom, which

prevent scratching of the table top after stacking. Stackability is indicated by a number in the price list, which expresses the maximum number of pieces that can be stacked.

! During stacking, it is necessary to act with great caution to prevent damage to the table top or other parts.



Lasu 406

**152**

TON R&amp;D

**252**

TON R&amp;D

**anix**

Lime studio

**casablanca** →

Tom Kelley

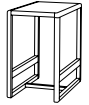
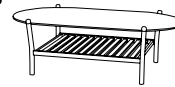

PRODUCT NUMBER	4M5 152	4M5 252	4U0 417	4U0 418	4U0 419	4U1 681
Type	table	table	coffee table	coffee table	coffee table	table
	solid wood top	solid wood top	multiplex top	multiplex top	multiplex top	multiplex top
			veneered	veneered	veneered	veneered
TABLE TOP SIZE (CM)	ø 80	ø 90	ø 65	ø 78	65 × 119	40 × 70
Extension to (cm)						
<b>PRICES IN € (VAT NOT INCLUDED)</b>						
Type of wood						
Beech	672,00	754,00	611,00	733,00	892,00	669,00
Oak			692,00	842,00	1 014,00	696,00
Oak rustic						
American walnut						
<b>SURCHARGES IN € (VAT NOT INCLUDED)</b>						
Beech						
Antique colour	36,00	41,00	25,00	34,00	48,00	23,00
Pigment colours						43,00
Oak						
Antique colour						
Pigment colours						43,00
Connecting set						
<b>TECHNICAL INFORMATION</b>						
Table top thickness (mm)	25	25	9	9	9	18
Total height (cm)	76	76	46	42	38	67
Height up to the apron (cm)	70,3	70,3	43,1	39,1	35,1	63,8
Distance between legs shorter (cm)			38	48	53	33,6
Distance between legs longer (cm)			39	50	72	63,6
Weight of product (kg)	14,3	17,6	4,5	5,9	8,4	9,1
Volume (m <sup>3</sup> /pc)	0,303	0,368	0,296	0,382	0,439	0,260
Carton dimensions (cm)	89 × 89 × 8	99 × 99 × 8	71 × 71 × 51	84 × 84 × 47	125 × 71 × 43	73 × 43 × 72
	51 × 51 × 77	56 × 56 × 77				
Bicolour						
Stackability						

# casablanca chop

Tom Kelley

Michal Riabič

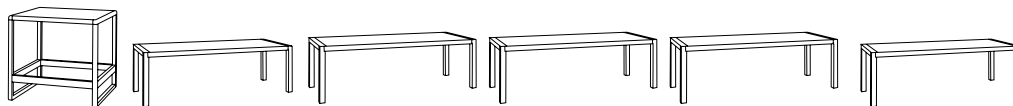

PRODUCT NUMBER	4U1 683	4M5 446	4M5 446	4M5 446	4M5 446	4M5 446
Type	table	table	table	table	table	table
	multiplex top	solid wood top	solid wood top	solid wood top	solid wood top	solid wood top
	veneered					
<b>TABLE TOP SIZE (CM)</b>	70 × 70	90 × 160	90 × 180	90 × 200	90 × 220	90 × 240
Extension to (cm)						
<b>PRICES IN € (VAT NOT INCLUDED)</b>						
Type of wood						
Beech	788,00	3 563,00	4 359,00	4 537,00	4 722,00	4 915,00
Oak	824,00	4 027,00	4 792,00	5 026,00	5 267,00	5 522,00
Oak rustic		4 027,00	4 792,00	4 775,00	5 004,00	5 246,00
American walnut						
<b>SURCHARGES IN € (VAT NOT INCLUDED)</b>						
Beech						
Antique colour	40,00	139,00	150,00	161,00	172,00	183,00
Pigment colours	76,00					
Oak						
Antique colour						
Pigment colours	76,00					
Connecting set						
<b>TECHNICAL INFORMATION</b>						
Table top thickness (mm)	18	25	25	25	25	25
Total height (cm)	67	76	76	76	76	76
Height up to the apron (cm)	63,8	67	67	67	67	67
Distance between legs shorter (cm)	63,6	76	76	76	76	76
Distance between legs longer (cm)	63,6	146	166	186	206	226
Weight of product (kg)	14	41	48,9	56,8	64,7	72,7
Volume (m <sup>3</sup> /pc)	0,466	0,592	0,646	0,753	0,755	0,755
Carton dimensions (cm)	75 × 75 × 72	158 × 99 × 18	181 × 101 × 18	211 × 111 × 18	238 × 99 × 18	238 × 99 × 18
		99 × 84 × 28	99 × 84 × 28	99 × 84 × 28	99 × 84 × 28	99 × 84 × 28
Bicolour						
Stackability						

## chop

Michal Riabič

## delta\_718

Kai Stania

## delta coffee

Kai Stania

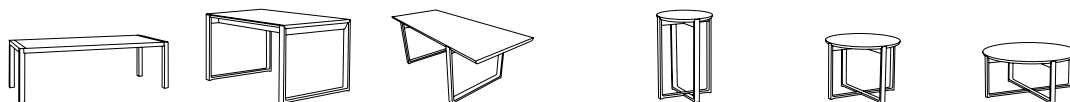

PRODUCT NUMBER	4M5 446	4NC 718	4NC 718	4MJ 722	4MJ 723	4MJ 724
Type	table	table	table	coffee table	coffee table	coffee table
	solid wood top	veneered top	veneered top	solid wood top	solid wood top	solid wood top
		solid wood edge	solid wood edge			
TABLE TOP SIZE (CM)	90 × 160	90 × 139	90 × 220	ø 40	ø 60	ø 80
Extension to (cm)	240					
<b>PRICES IN € (VAT NOT INCLUDED)</b>						
Type of wood						
Beech	7 086,00	1 930,00	2 120,00	438,00	553,00	663,00
Oak	7 625,00	2 189,00	2 497,00	475,00	602,00	736,00
Oak rustic	7 244,00			475,00	602,00	736,00
American walnut						
<b>SURCHARGES IN € (VAT NOT INCLUDED)</b>						
Beech						
Antique colour	183,00	98,00	154,00	24,00	33,00	48,00
Pigment colours		188,00	297,00	45,00	63,00	93,00
Oak						
Antique colour						
Pigment colours		188,00	297,00			
Connecting set						
<b>TECHNICAL INFORMATION</b>						
Table top thickness (mm)	25	35	35	20	20	20
Total height (cm)	76	76	76	60	45	35
Height up to the apron (cm)	64	64,5	64,5	54	39	29
Distance between legs shorter (cm)	76	84,2	84,2	24	38	52,2
Distance between legs longer (cm)	146/226	123	141,6	24	38	52,2
Weight of product (kg)	81	55	68	3,5	6,2	9,6
Volume (m <sup>3</sup> /pc)	0,592	0,561	0,653	0,159	0,256	0,349
Carton dimensions (cm)	158 × 99 × 18	149 × 99 × 33	229 × 99 × 25	45 × 45 × 68	66 × 66 × 51	86 × 86 × 41
	99 × 84 × 28					
Bicolour				✓	✓	✓
Stackability						

# delta coffee

Kai Stania

# ink\_44

Michal Riabič

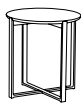

PRODUCT NUMBER	4MJ 725	4MJ 726	4MJ 727	4ME 448	4ME 448	4ME 448
Type	coffee table	coffee table	coffee table	table **	table **	table **
	solid wood top	solid wood top	solid wood top	solid wood top	solid wood top	solid wood top
<b>TABLE TOP SIZE (CM)</b>	ø 60	ø 80	ø 80	90 × 160	90 × 180	90 × 200
Extension to (cm)						
<b>PRICES IN € (VAT NOT INCLUDED)</b>						
Type of wood						
Beech	646,00	784,00	693,00	2 286,00	2 581,00	2 599,00
Oak	718,00	879,00	773,00	2 723,00	3 231,00	3 574,00
Oak rustic	718,00	879,00	773,00	2 723,00	3 231,00	3 249,00
American walnut						
<b>SURCHARGES IN € (VAT NOT INCLUDED)</b>						
Beech						
Antique colour	34,00	50,00	49,00	127,00	125,00	143,00
Pigment colours	65,00	95,00	94,00			
Oak						
Antique colour						
Pigment colours						
Connecting set						
<b>TECHNICAL INFORMATION</b>						
Table top thickness (mm)	20	20	20	33	33	33
Total height (cm)	60	60	45	76	76	76
Height up to the apron (cm)	54	54	39	72,7	72,7	72,7
Distance between legs shorter (cm)	38	52,2	52,2	74	74	74
Distance between legs longer (cm)	38	52,2	52,2	144	164	184
Weight of product (kg)	6,2	9,9	9,7	57,6	62,1	66,6
Volume (m <sup>3</sup> /pc)	0,331	0,562	0,434	0,377	0,418	0,504
Carton dimensions (cm)	66 × 66 × 66	86 × 86 × 66	86 × 86 × 51	171 × 101 × 18	191 × 101 × 18	211 × 111 × 18
				78 × 21 × 10	78 × 21 × 10	78 × 21 × 10
Bicolour	√	√	√			
Stackability						

\*\* Lead time approx. 12 weeks.



**ink\_44**

Michal Riabič

**ironica**

Tom Kelley

**jylland**

Mads K. Johansen



PRODUCT NUMBER	4ME 448	4UG 134	4F1 134	4UG 135	4F1 135	4M5 476
Type	table **	table	table	table	table	table
	solid wood top	multiplex top	MDF top	multiplex top	MDF top	solid wood top
		veneered	veneered	veneered	veneered	
TABLE TOP SIZE (CM)	100 × 200	80 × 80	80 × 80	80 × 120	80 × 120	80 × 120
Extension to (cm)						
<b>PRICES IN € (VAT NOT INCLUDED)</b>						
Type of wood						
Beech	2 627,00	609,00	387,00	790,00	481,00	1 097,00
Oak	3 621,00					1 521,00
Oak rustic	3 291,00					1 521,00
American walnut						
<b>SURCHARGES IN € (VAT NOT INCLUDED)</b>						
Beech						
Antique colour	158,00	50,00	50,00	75,00	75,00	102,00
Pigment colours		82,00	82,00	126,00	126,00	
Oak						
Antique colour						
Pigment colours						
Connecting set			30,00		30,00	
<b>TECHNICAL INFORMATION</b>						
Table top thickness (mm)	33	12	18	12	18	25
Total height (cm)	76	75,4	76	75,4	76	76
Height up to the apron (cm)	72,7	70,2	70,2	70,2	70,2	68,7
Distance between legs shorter (cm)	84	46	46	46	46	57
Distance between legs longer (cm)	184	46	46	86	86	97
Weight of product (kg)	71,6	17,9	18,6	24	25	25,7
Volume (m <sup>3</sup> /pc)	0,504	0,065	0,065	0,096	0,096	0,279
Carton dimensions (cm)	211 × 111 × 18	84 × 84 × 8	84 × 84 × 8	84 × 124 × 8	84 × 124 × 8	101 × 150 × 16
	78 × 21 × 10					
Bicolour						
Stackability						

\*\* Lead time approx. 12 weeks.



PRODUCT NUMBER	4M5 476	4M5 476	4M5 476	4M5 476	4M5 476	4M5 476
Type	table	table	table	table **	table **	table **
	solid wood top	solid wood top	solid wood top	solid wood top	solid wood top	solid wood top
<b>TABLE TOP SIZE (CM)</b>	90 × 140	90 × 160	90 × 180	90 × 200	100 × 200	90 × 140
Extension to (cm)						200
<b>PRICES IN € (VAT NOT INCLUDED)</b>						
Type of wood						
Beech	1 229,00	1 339,00	1 489,00	1 697,00	1 863,00	2 630,00
Oak	1 701,00	1 930,00	2 067,00	2 587,00	2 968,00	3 684,00
Oak rustic	1 701,00	1 930,00	2 067,00	2 351,00	2 698,00	3 349,00
American walnut						
<b>SURCHARGES IN € (VAT NOT INCLUDED)</b>						
Beech						
Antique colour	134,00	152,00	171,00	190,00	210,00	190,00
Pigment colours						
Oak						
Antique colour						
Pigment colours						
Connecting set						
<b>TECHNICAL INFORMATION</b>						
Table top thickness (mm)	25	25	25	25	25	25
Total height (cm)	76	76	76	76	76	76
Height up to the apron (cm)	68,7	68,7	68,7	68,7	68,7	65,4
Distance between legs shorter (cm)	67	67	67	67	77	67
Distance between legs longer (cm)	117	137	157	177	177	117/177
Weight of product (kg)	31,8	35,5	39,3	43	47,1	56,3
Volume (m <sup>3</sup> /pc)	0,309	0,309	0,381	0,381	0,513	0,420
Carton dimensions (cm)	99 × 169 × 16	99 × 169 × 16	99 × 209 × 16	99 × 209 × 16	111 × 251 × 16	101 × 171 × 16 98 × 82 × 11
Bicolour						
Stackability						

\*\* Lead time approx. 12 weeks.



PRODUCT NUMBER	4M5 476	4M5 476	4M5 476	4M5 476	4MJ 406	4NJ 406
Type	table **	table **	table **	table **	table	table
	solid wood top	solid wood top	solid wood top	solid wood top	solid wood top	veneered top solid wood edge
<b>TABLE TOP SIZE (CM)</b>	90 × 160	90 × 180	90 × 200	100 × 200	90 × 90	90 × 90
Extension to (cm)	<b>220</b>	<b>240</b>	<b>260</b>	<b>260</b>		
<b>PRICES IN € (VAT NOT INCLUDED)</b>						
Type of wood						
Beech	<b>2 731,00</b>	<b>2 879,00</b>	<b>3 032,00</b>	<b>3 229,00</b>	<b>1 104,00</b>	<b>1 169,00</b>
Oak	<b>3 864,00</b>	<b>4 201,00</b>	<b>4 266,00</b>	<b>4 711,00</b>	<b>1 385,00</b>	<b>1 424,00</b>
Oak rustic	<b>3 512,00</b>	<b>3 571,00</b>	<b>3 627,00</b>	<b>4 005,00</b>	<b>1 385,00</b>	
American walnut						
<b>SURCHARGES IN € (VAT NOT INCLUDED)</b>						
Beech						
Antique colour	<b>209,00</b>	<b>228,00</b>	<b>247,00</b>	<b>275,00</b>	<b>65,00</b>	<b>65,00</b>
Pigment colours						<b>125,00</b>
Oak						
Antique colour						
Pigment colours						<b>125,00</b>
Connecting set					<b>30,00</b>	<b>30,00</b>
<b>TECHNICAL INFORMATION</b>						
Table top thickness (mm)	25	25	25	25	20	20
Total height (cm)	76	76	76	76	76	76
Height up to the apron (cm)	65,4	65,4	65,4	65,4	66,5	66,5
Distance between legs shorter (cm)	67	67	67	77	76	76
Distance between legs longer (cm)	137/197	157/217	177/237	177/237	76	76
Weight of product (kg)	61,2	66,1	71	78,1	20	20
Volume (m <sup>3</sup> /pc)	0,420	0,483	0,483	0,625	0,188	0,188
Carton dimensions (cm)	101 × 171 × 16	99 × 209 × 16	99 × 209 × 16	111 × 251 × 16	101 × 101 × 16	101 × 101 × 16
	98 × 82 × 11	98 × 82 × 11	98 × 82 × 11	108 × 82 × 11		
Bicolour						
Stackability					4	4

\*\* Lead time approx. 12 weeks.

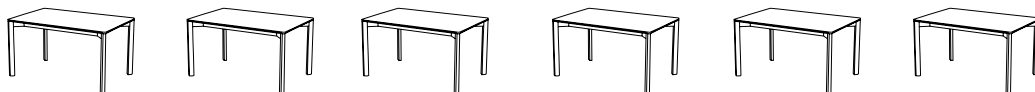

PRODUCT NUMBER	4MJ 406	4NJ 406	4MJ 406	4NJ 406	4MJ 406	4NJ 406
Type	table	table	table	table	table	table
	solid wood top	veneered top	solid wood top	veneered top	solid wood top	veneered top
		solid wood edge		solid wood edge		solid wood edge
<b>TABLE TOP SIZE (CM)</b>	90 × 139	90 × 139	90 × 160	90 × 160	90 × 180	90 × 180
Extension to (cm)						
<b>PRICES IN € (VAT NOT INCLUDED)</b>						
Type of wood						
Beech	1 386,00	1 442,00	1 466,00	1 505,00	1 564,00	1 667,00
Oak	1 666,00	1 714,00	1 801,00	1 823,00	2 053,00	2 012,00
Oak rustic	1 666,00		1 801,00		2 053,00	
American walnut						
<b>SURCHARGES IN € (VAT NOT INCLUDED)</b>						
Beech						
Antique colour	100,00	100,00	115,00	115,00	130,00	130,00
Pigment colours		192,00		221,00		250,00
Oak						
Antique colour						
Pigment colours		192,00		221,00		250,00
Connecting set	30,00	30,00	30,00	30,00	30,00	30,00
<b>TECHNICAL INFORMATION</b>						
Table top thickness (mm)	20	20	20	20	20	20
Total height (cm)	76	76	76	76	76	76
Height up to the apron (cm)	66,5	66,5	66,5	66,5	66,5	66,5
Distance between legs shorter (cm)	76	76	76	76	76	76
Distance between legs longer (cm)	125	125	146	146	166	166
Weight of product (kg)	28	28	31	31	34	34
Volume (m <sup>3</sup> /pc)	0,279	0,279	0,318	0,318	0,379	0,379
Carton dimensions (cm)	150 × 101 × 16	150 × 101 × 16	171 × 101 × 16	171 × 101 × 16	196 × 105 × 16	196 × 105 × 16
<b>Bicolour</b>						
Stackability	4	4	4	4	3	3

# lasu

Alexander Gufler

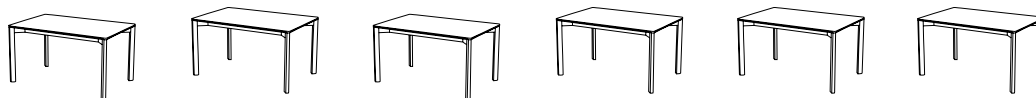

PRODUCT NUMBER	4ME 409	4N8 409	4ME 409	4N8 409	4ME 409	4N8 409
Type	table **	table **	table **	table **	table **	table **
	solid wood top	veneered top	solid wood top	veneered top	solid wood top	veneered top
		solid wood edge		solid wood edge		solid wood edge
<b>TABLE TOP SIZE (CM)</b>	100 × 220	100 × 220	100 × 240	100 × 240	100 × 260	100 × 260
Extension to (cm)						
<b>PRICES IN € (VAT NOT INCLUDED)</b>						
Type of wood						
Beech	3 184,00	2 717,00	3 219,00	2 860,00	3 238,00	3 062,00
Oak	4 916,00	3 037,00	4 956,00	3 187,00	4 969,00	3 342,00
Oak rustic	4 469,00		4 213,00		4 224,00	
American walnut						
<b>SURCHARGES IN € (VAT NOT INCLUDED)</b>						
Beech						
Antique colour	169,00	169,00	184,00	184,00	202,00	202,00
Pigment colours		328,00		357,00		385,00
Oak						
Antique colour						
Pigment colours		328,00		357,00		385,00
Connecting set						
<b>TECHNICAL INFORMATION</b>						
Table top thickness (mm)	33	38	33	38	33	38
Total height (cm)	75,5	76	75,5	76	75,5	76
Height up to the apron (cm)	64,2	64,2	64,2	64,2	64,2	64,2
Distance between legs shorter (cm)	82	82	82	82	82	82
Distance between legs longer (cm)	202	202	222	222	242	242
Weight of product (kg)	74	82	76	84,3	85,1	94,1
Volume (m <sup>3</sup> /pc)	0,513	0,513	0,513	0,513	0,555	0,555
Carton dimensions (cm)	251 × 111 × 16	251 × 111 × 16	251 × 111 × 16	251 × 111 × 16	271 × 111 × 16	271 × 111 × 16
Bicolour						
Stackability						

\*\* Lead time approx. 12 weeks.

lasu

Alexander Gufler

leaf

E-ggs

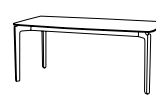
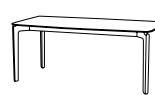
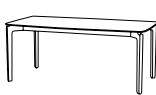

PRODUCT NUMBER	4ME 409	4N8 409	4MJ 442	4UJ 442	4MJ 442	4UJ 442
Type	table **	table **	table	table	table	table
	solid wood top	veneered top	solid wood top	multiplex top	solid wood top	multiplex top
		solid wood edge		veneered		veneered
TABLE TOP SIZE (CM)	100 × 300	100 × 295	94 × 160	94 × 160	94 × 185	94 × 185
Extension to (cm)						
<b>PRICES IN € (VAT NOT INCLUDED)</b>						
Type of wood						
Beech	3 630,00	3 366,00	1 658,00	1 884,00	1 702,00	1 961,00
Oak	5 692,00	3 792,00	2 065,00	2 257,00	2 112,00	2 359,00
Oak rustic	4 269,00		2 065,00		2 112,00	
American walnut						
<b>SURCHARGES IN € (VAT NOT INCLUDED)</b>						
Beech						
Antique colour	233,00	233,00	119,00	119,00	139,00	139,00
Pigment colours		445,00		228,00		267,00
Oak						
Antique colour						
Pigment colours		445,00		228,00		267,00
Connecting set						
<b>TECHNICAL INFORMATION</b>						
Table top thickness (mm)	33	38	20	20	20	20
Total height (cm)	75,5	76	76	76	76	76
Height up to the apron (cm)	64,2	64,2	66,5	66,5	66,5	66,5
Distance between legs shorter (cm)	82	82	73	73	73	73
Distance between legs longer (cm)	282	277	139,5	139,5	165	165
Weight of product (kg)	95,5	104	32	32	36	36
Volume (m <sup>3</sup> /pc)	0,636	0,636	0,379	0,379	0,379	0,379
Carton dimensions (cm)	311 × 111 × 16	311 × 111 × 16	105 × 196 × 16	105 × 196 × 16	105 × 196 × 16	105 × 196 × 16
Bicolour						
Stackability						

\*\* Lead time approx. 12 weeks.

## leaf

E-ggs



PRODUCT NUMBER	4MJ 442	4UJ 442	4MJ 442	4UJ 442	4MJ 443	4UJ 443
Type	table	table	table	table	table	table
	solid wood top	multiplex top	solid wood top	multiplex top	solid wood top	multiplex top
		veneered		veneered		veneered
TABLE TOP SIZE (CM)	94 × 200	94 × 200	105 × 240	105 × 240	ø 127	ø 127
Extension to (cm)						
<b>PRICES IN € (VAT NOT INCLUDED)</b>						
Type of wood						
Beech	1 963,00	2 182,00	2 293,00	2 485,00	1 398,00	1 826,00
Oak	2 728,00	2 617,00	2 857,00	2 993,00	1 723,00	2 129,00
Oak rustic	2 480,00		2 629,00		1 723,00	
American walnut						
<b>SURCHARGES IN € (VAT NOT INCLUDED)</b>						
Beech						
Antique colour	148,00	148,00	199,00	199,00	102,00	102,00
Pigment colours		285,00		382,00		195,00
Oak						
Antique colour						
Pigment colours		285,00		382,00		195,00
Connecting set						
<b>TECHNICAL INFORMATION</b>						
Table top thickness (mm)	20	20	20	20	20	20
Total height (cm)	76	76	76	76	76	76
Height up to the apron (cm)	66,5	66,5	66,5	66,5	66,5	66,5
Distance between legs shorter (cm)	73	73	80	80	78	78
Distance between legs longer (cm)	179,5	179,5	218	218	78	78
Weight of product (kg)	38,5	38,5	48	48	28	28
Volume (m <sup>3</sup> /pc)	0,432	0,432	0,555	0,555	0,351	0,351
Carton dimensions (cm)	211 × 111 × 16	211 × 111 × 16	271 × 111 × 16	271 × 111 × 16	138 × 138 × 16	138 × 138 × 16
Bicolour						
Stackability						

# malmö

Michal Riabič

# stelvio

Alexander Gufler



PRODUCT NUMBER	4ME 706	4ME 706	4ME 706	4ME 706	4ME 707	4M5 716
Type	table **	table **	table **	table **	table **	table **
	solid wood top	solid wood top	solid wood top	solid wood top	solid wood top	solid wood top
<b>TABLE TOP SIZE (CM)</b>	90 × 90	90 × 140	90 × 170	90 × 200	∅ 120	90 × 200
Extension to (cm)						
<b>PRICES IN € (VAT NOT INCLUDED)</b>						
Type of wood						
Beech	1 041,00	1 580,00	1 771,00	2 038,00	1 501,00	2 532,00
Oak	1 646,00	2 257,00	2 537,00	3 391,00	2 268,00	2 934,00
Oak rustic	1 646,00	2 257,00	2 537,00	3 082,00	2 268,00	2 667,00
American walnut						
<b>SURCHARGES IN € (VAT NOT INCLUDED)</b>						
Beech						
Antique colour	80,00	124,00	150,00	176,00	111,00	142,00
Pigment colours						
Oak						
Antique colour						
Pigment colours						
Connecting set						
<b>TECHNICAL INFORMATION</b>						
Table top thickness (mm)	33	33	33	33	33	25
Total height (cm)	76	76	76	76	76	76
Height up to the apron (cm)	72,7	72,7	72,7	72,7	72,7	73,5
Distance between legs shorter (cm)	51	51	51	51	53	32,5
Distance between legs longer (cm)	51	97	127	157	53	110
Weight of product (kg)	25,1	36,3	41,2	46,1	34,9	45
Volume (m <sup>3</sup> /pc)	0,135	0,236	0,236	0,236	0,198	0,590
Carton dimensions (cm)	99 × 99 × 8	99 × 209 × 8	99 × 209 × 8	99 × 209 × 8	129 × 129 × 8	231 × 101 × 11
	85 × 17 × 27	85 × 17 × 27	85 × 17 × 27	85 × 17 × 27	85 × 17 × 27	161 × 99 × 16
Bicolour	√	√	√	√	√	√
Stackability						

3



# stelvio

Alexander Gufler



PRODUCT NUMBER	4N8 716	4M5 716	4N8 716	4M5 716	4N8 716	4ME 717
Type	table **	table **	table **	table **	table **	table **
	veneered top	solid wood top	veneered top	solid wood top	veneered top	solid wood top
	solid wood edge		solid wood edge		solid wood edge	
<b>TABLE TOP SIZE (CM)</b>	90 × 200	90 × 220	90 × 220	100 × 280	100 × 280	120 × 350
Extension to (cm)						
<b>PRICES IN € (VAT NOT INCLUDED)</b>						
Type of wood						
Beech	2 409,00	2 571,00	2 529,00	3 084,00	2 930,00	3 385,00
Oak	2 512,00	3 436,00	2 628,00	4 768,00	3 082,00	7 188,00
Oak rustic		3 124,00		4 053,00		5 391,00
American walnut	3 109,00		3 320,00		3 793,00	
<b>SURCHARGES IN € (VAT NOT INCLUDED)</b>						
Beech						
Antique colour	142,00	158,00	158,00	213,00	213,00	301,00
Pigment colours	273,00		304,00		410,00	
Oak						
Antique colour						
Pigment colours	273,00		304,00		410,00	
Connecting set						
<b>TECHNICAL INFORMATION</b>						
Table top thickness (mm)	38	25	38	25	38	33
Total height (cm)	76	76	76	76	76	75,5
Height up to the apron (cm)	72,2	73,5	72,2	73,5	72,2	72,2
Distance between legs shorter (cm)	32,5	32,5	32,5	32,5	32,5	49,5
Distance between legs longer (cm)	110	130	130	190	190	254
Weight of product (kg)	61,5	50	68	64	89	136
Volume (m <sup>3</sup> /pc)	0,590	0,590	0,590	0,794	0,794	1,186
Carton dimensions (cm)	231 × 101 × 11	231 × 101 × 11	231 × 101 × 11	291 × 111 × 11	291 × 111 × 11	361 × 131 × 11
	161 × 99 × 16	161 × 99 × 16	161 × 99 × 16	211 × 99 × 16	211 × 99 × 16	275 × 116 × 16
Bicolour						
Stackability						

\*\* Lead time approx. 12 weeks.

# stockholm

Mads K. Johansen



PRODUCT NUMBER	4M5 700	4D6 700	4M5 700	4D6 700	4M5 700	4D6 700
Type	table	table	table	table	table	table
	solid wood top	veneered top	solid wood top	veneered top	solid wood top	veneered top
		veneered edge		veneered edge		veneered edge
<b>TABLE TOP SIZE (CM)</b>	80 × 120	80 × 120	90 × 90	90 × 90	90 × 160	90 × 160
Extension to (cm)						
<b>PRICES IN € (VAT NOT INCLUDED)</b>						
Type of wood						
Beech	1 073,00	1 068,00	934,00	903,00	1 348,00	1 221,00
Oak	1 497,00	1 400,00	1 388,00	1 278,00	1 908,00	1 537,00
Oak rustic	1 497,00		1 388,00		1 908,00	
American walnut						
<b>SURCHARGES IN € (VAT NOT INCLUDED)</b>						
Beech						
Antique colour	77,00	77,00	65,00	65,00	115,00	115,00
Pigment colours		148,00		125,00		221,00
Oak						
Antique colour						
Pigment colours		148,00		125,00		221,00
Connecting set						
<b>TECHNICAL INFORMATION</b>						
Table top thickness (mm)	25	28	25	28	25	28
Total height (cm)	75,7	76	75,7	76	75,7	76
Height up to the apron (cm)	65,6	65,6	65,6	65,6	65,6	65,6
Distance between legs shorter (cm)	68,4	68,4	78,4	78,4	78,4	78,4
Distance between legs longer (cm)	104	104	74	74	144	144
Weight of product (kg)	28	30	23,7	25,4	42,1	45,1
Volume (m <sup>3</sup> /pc)	0,212	0,212	0,181	0,181	0,318	0,318
Carton dimensions (cm)	129 × 89 × 16	129 × 89 × 16	99 × 99 × 16	99 × 99 × 16	171 × 101 × 16	171 × 101 × 16
Bicolour	✓	✓	✓	✓	✓	✓
Stackability						

# stockholm

Mads K. Johansen

# trapez

designschneider

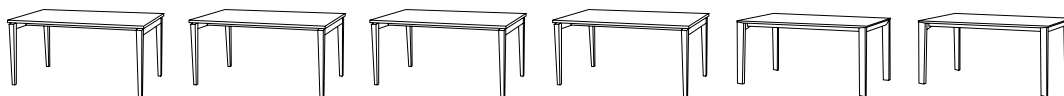

PRODUCT NUMBER	4M5 700	4D6 700	4M5 700	4D6 700	4NJ 708	4NJ 708
Type	table **	table	table **	table	table	table
	solid wood top	veneered top	solid wood top	veneered top	veneered top	veneered top
		veneered edge		veneered edge	solid wood edge	solid wood edge
TABLE TOP SIZE (CM)	90 × 200	90 × 200	90 × 160	90 × 160	90 × 160	100 × 240
Extension to (cm)			220	220		
<b>PRICES IN € (VAT NOT INCLUDED)</b>						
Type of wood						
Beech	1 438,00	1 412,00	2 451,00	2 461,00	2 309,00	3 146,00
Oak	2 498,00	1 801,00	3 765,00	3 044,00	2 749,00	3 597,00
Oak rustic	2 271,00		3 423,00			
American walnut						
<b>SURCHARGES IN € (VAT NOT INCLUDED)</b>						
Beech						
Antique colour	138,00	138,00	153,00	153,00	115,00	191,00
Pigment colours		266,00		294,00	221,00	368,00
Oak						
Antique colour						
Pigment colours		266,00		294,00	221,00	368,00
Connecting set						
<b>TECHNICAL INFORMATION</b>						
Table top thickness (mm)	25	28	25	28	20	20
Total height (cm)	75,7	76	75,7	76	76	76
Height up to the apron (cm)	65,6	65,6	65,6	65,6	65	65
Distance between legs shorter (cm)	78,4	78,4	78,4	78,4	78	88
Distance between legs longer (cm)	184	184	144/204	144/204	142	222
Weight of product (kg)	52,6	56,3	57,8	61,9	46,5	59,5
Volume (m³/pc)	0,381	0,381	0,309	0,309	0,566	0,744
Carton dimensions (cm)	209 × 99 × 16	209 × 99 × 16	169 × 99 × 16	169 × 99 × 16	171 × 101 × 16 99 × 84 × 28	251 × 111 × 14 109 × 84 × 28
Bicolour	√	√	√	√		
Stackability						

\*\* Lead time approx. 12 weeks.



PRODUCT NUMBER	4NJ 708	4NJ 708	4NJ 708	4MJ 421	4MJ 422	4MJ 423
Type	table	table	table	coffee table	coffee table	coffee table
	veneered top	veneered top	veneered top	solid wood top	solid wood top	solid wood top
	solid wood edge	solid wood edge	solid wood edge			
<b>TABLE TOP SIZE (CM)</b>	90 × 160	100 × 240	100 × 240	ø 45	ø 60	ø 80
Extension to (cm)	<b>220</b>	<b>300</b>	<b>340</b>			
<b>PRICES IN € (VAT NOT INCLUDED)</b>						
Type of wood						
Beech	<b>3 649,00</b>	<b>4 557,00</b>	<b>4 896,00</b>	<b>318,00</b>	<b>376,00</b>	<b>517,00</b>
Oak	<b>4 073,00</b>	<b>4 932,00</b>	<b>5 286,00</b>	<b>339,00</b>	<b>418,00</b>	<b>589,00</b>
Oak rustic				<b>339,00</b>	<b>418,00</b>	<b>589,00</b>
American walnut						
<b>SURCHARGES IN € (VAT NOT INCLUDED)</b>						
Beech						
Antique colour	<b>158,00</b>	<b>239,00</b>	<b>271,00</b>	<b>20,00</b>	<b>27,00</b>	<b>42,00</b>
Pigment colours	<b>304,00</b>	<b>460,00</b>	<b>521,00</b>	<b>39,00</b>	<b>52,00</b>	<b>80,00</b>
Oak						
Antique colour						
Pigment colours	<b>304,00</b>	<b>460,00</b>	<b>521,00</b>			
Connecting set						
<b>TECHNICAL INFORMATION</b>						
Table top thickness (mm)	20	20	20	20	20	20
Total height (cm)	76	76	76	50	42,5	35
Height up to the apron (cm)	65	65	65	48	40,5	33
Distance between legs shorter (cm)	78	88	88			
Distance between legs longer (cm)	140/200	220/280	220/320			
Weight of product (kg)	54	77,5	86,2	3,7	5,8	9
Volume (m <sup>3</sup> /pc)	0,566	0,744	0,744	0,037	0,048	0,079
Carton dimensions (cm)	171 × 101 × 16	251 × 111 × 14	251 × 111 × 14	67,5 × 47 × 10	68,5 × 59,5 × 10	88,5 × 77 × 10
	99 × 84 × 28	109 × 84 × 28	109 × 84 × 28			
Bicolour						
Stackability						

# p.o.v. collection

Modularity and organically shaped table bases. P.O.V. tables have an unassuming appearance, but can also become the focal point of the room. This depends only on the point of view you choose. The collection includes coffee, dining and bar heights, three types of table base and table tops in six shapes. Overall, this modular system can create dozens of variants, and can be accessorised by a stackable stool with the same name.



## Table top

**M – solid wood top** – the basic material is a solid wood top consisting of wooden prisms glued together (so-called piedrot). Colour differences must be considered for solid wood piedrot, as individual glued prisms may react differently to the finishing materials. Dimension tolerance of  $\pm 3$  mm is defined for solid wood table top, since wood as a natural material naturally reacts to the ambient environment. The natural reactions may also include spontaneous sag of the table top. Table top with the size above 50 cm are therefore supplied with a reinforcement on the bottom side.

**Y – High-pressure laminate** – the basic material is a multiplex board laminated with high-pressure laminate (HPL) with thickness of 0.8 mm. The multiplex consists of layers of veneer applied crosswise onto each other, glued and pressed similarly to plywood. The multiplex is distinguished by a greater thickness of the internal veneers, thus the properties of these pressed boards approach solid wood.

**Z – High-pressure laminate with nanotechnology** – the basic material is a multiplex board coated with high-pressure 0.9 mm laminate with nanotechnology pressed onto the top side.

The multiplex consists of layers of veneer applied crosswise onto each other, glued and pressed similarly to plywood. The multiplex is distinguished by a greater thickness of the internal veneers, thus the properties of these pressed boards approach solid wood. We offer the laminate with nanotechnology in the colours L20 – white and L123 – black.

**B – multiplex top** – the table top is made of plywood from beech veneers, veneered from both sides. Individual layers of veneers are applied crosswise, glued and pressed together.

**U – multiplex top + veneered surface** – the basic material is a multiplex board veneered with beech or oak veneer on the top. It is characterized by higher thickness of the inner veneers, so the properties of the pressed boards approach solid wood. Depending on the shape of the edges, the veneers can also be pressed to the edge or its part. Otherwise, characteristic layers of the pressed veneers are visible on the edge.

Click on this [link](#) for detailed photographs.

Multiplex table tops with HPL (marked as Y) and nanolaminate (marked as Z) finish come with natural edge regardless of the HPL, nanolaminate or the base colour. If you are interested in a different colour edge please contact your dealer, who will check this option for you.



## Shape of the table top

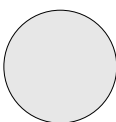

1 Circle

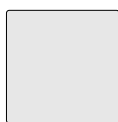

2 Square

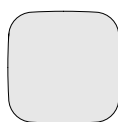

3 Spheric square

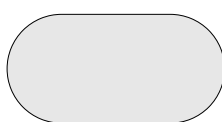

4 Oval



5 Rectangle



6 Spheric rectangle

## Bases

You will find three types of table base in the collection – a simple, central leg with a three-sided conical shape, a combination of two such legs, and a long central base. The latter two provide greater stability for larger table tops. The table bases are available in heights suitable for coffee tables, din-

ing tables and bar tables. The coffee table comes with a simple central leg only, but the bar table offers a choice between a simple central leg and a long central base.

! To ensure complete stability, we provide weights for all bases. The specific weight depends on the size of the selected base and table top.

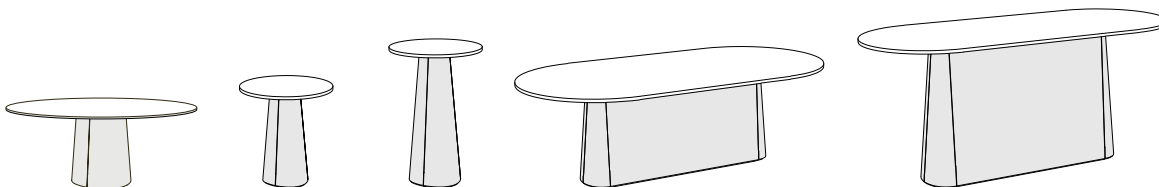

## Table colours and finishes

P.O.V. tables and table tops can be finished as outlined in the chapter 'Wood, colours, surface finishes'. The bicolour option is available for this collection.



## Edges

All table tops can be finished with rounded, bevelled and straight edges.



## Accessories

The collection includes several optional extras. All tables can be supplied with openings for cables and power outlets/USB ports. If you wish to select a specific power outlet/port, please contact your sales representative. This optional extra is particularly suitable for tables for offices and meeting rooms.

The hook is intended for bistro tables and has a maximum carrying capacity of 5 kg.



! The price list does not include surcharges for power outlets/USB ports. Such surcharges depend on the number and type of outlets/ports selected by the customer.

! The hook is supplied separately together with fastening screws and installation instructions. The space identified for the placement of the hook is indicated on the underside of the table top.

p.o.v.

kaschkasch



TYPE	table	table	table	table	table	table
------	-------	-------	-------	-------	-------	-------

TABLE TOP SIZE (CM)	ø 60	ø 70	ø 80	60 × 60	70 × 70	80 × 80
---------------------	------	------	------	---------	---------	---------

Extension to (cm)

**PRICES IN € (VAT NOT INCLUDED)**

**PRODUCT NUMBER**

Beech

Table top options

4M5 460 Solid wood	1 046,00	1 128,00	1 172,00	1 074,00	1 161,00	1 228,00
4LJ 460 Veneered multiplex**	1 038,00	1 078,00	1 113,00	1 036,00	1 104,00	1 150,00
4BJ 460 Multiplex	996,00	1 055,00	1 082,00	1 017,00	1 081,00	1 119,00
4YJ 460 Multiplex + HPL laminate****	1 068,00	1 200,00	1 203,00	1 081,00	1 216,00	1 224,00
4ZJ 460 Multiplex + nanolaminate	1 146,00	1 425,00	1 432,00	1 159,00	1 440,00	1 453,00

Oak

Table top options

4M5 460 Solid wood	1 146,00	1 244,00	1 304,00	1 170,00	1 282,00	1 355,00
4M5 460 Solid wood, rustic	1 146,00	1 244,00	1 304,00	1 170,00	1 282,00	1 355,00
4LJ 460 Veneered multiplex**	1 114,00	1 170,00	1 210,00	1 121,00	1 191,00	1 241,00
4YJ 460 Multiplex + HPL laminate****	1 134,00	1 266,00	1 269,00	1 147,00	1 282,00	1 290,00
4ZJ 460 Multiplex + nanolaminate	1 212,00	1 491,00	1 498,00	1 225,00	1 506,00	1 519,00

American walnut

Table top options

4M5 460 Solid wood	1 378,00	1 548,00	1 691,00	1 404,00	1 586,00	1 738,00
4LJ 460 Veneered multiplex**	1 243,00	1 295,00	1 369,00	1 260,00	1 318,00	1 398,00
4YJ 460 Multiplex + HPL laminate****	1 153,00	1 285,00	1 288,00	1 166,00	1 301,00	1 309,00
4ZJ 460 Multiplex + nanolaminate	1 231,00	1 510,00	1 517,00	1 244,00	1 525,00	1 538,00

**SURCHARGES IN € (VAT NOT INCLUDED)**

Beech

Antique colour	35,00	38,00	42,00	37,00	41,00	46,00
Pigment colours	65,00	72,00	80,00	70,00	79,00	89,00

Oak

Antique colour

Pigment colours	65,00	72,00	80,00	70,00	79,00	89,00
-----------------	-------	-------	-------	-------	-------	-------

**TECHNICAL INFORMATION**

Shape of the table top	1	1	1	2/3	2/3	2/3
Table top thickness (mm) - solid wood	25	25	25	25	25	25
Table top thickness (mm) - multiplex	20	20	20	20	20	20
Total height (cm) - solid wood	75,5	75,5	75,5	75,5	75,5	75,5
Total height (cm) - multiplex	75	75	75	75	75	75
Height up to the apron (cm)	73	73	73	73	73	73
Pedestal dimension (cm)	35 × 35	35 × 35	35 × 35	35 × 35	35 × 35	35 × 35
Weight of product (kg) - solid wood	29,5	36,6	38,8	36,1/35,5	43,7/43	51,7/50,8
Weight of product (kg) - multiplex	28,7	35,5	37,5	35,1/34,5	42,3/41,6	50/49,1
Volume (m³/pc)	0,607	0,621	0,636	0,607	0,621	0,636
Carton dimensions (cm)	69 × 69 × 8	79 × 79 × 8	89 × 89 × 8	69 × 69 × 8	79 × 79 × 8	89 × 89 × 8
	75 × 75 × 87	75 × 75 × 87	75 × 75 × 87	75 × 75 × 87	75 × 75 × 87	75 × 75 × 87

Bicolour	✓	✓	✓	✓	✓	✓
----------	---	---	---	---	---	---

Shape of the table top: 1 - circle, 2 - square, 3 - spheric square

\*\* Lead time apx 12 weeks.

\*\*\*\* The prices are valid for black (L123) and white (L20); other colour finishes are available on request.

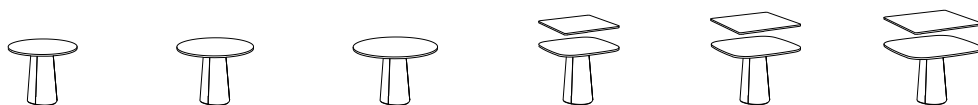

TYPE	table	table	table	table	table	table
<b>TABLE TOP SIZE (CM)</b>	ø 90	ø 100	ø 110	90 × 90	100 × 100	110 × 110
Extension to (cm)						
<b>PRICES IN € (VAT NOT INCLUDED)</b>						
<b>PRODUCT NUMBER</b>						
Beech						
Table top options						
4M5 461 Solid wood	1 246,00	1 488,00	1 707,00	1 299,00	1 547,00	1 771,00
4UJ 461 Veneered multiplex **	1 174,00	1 404,00	1 509,00	1 221,00	1 456,00	1 567,00
4BJ 461 Multiplex	1 132,00	1 344,00	1 419,00	1 180,00	1 402,00	1 478,00
4YJ 461 Multiplex + HPL laminate *****	1 242,00	1 545,00	1 728,00	1 271,00	1 593,00	1 789,00
4ZJ 461 Multiplex + nanolaminate	1 470,00	1 838,00	2 034,00	1 499,00	1 882,00	2 079,00
Oak						
Table top options						
4M5 461 Solid wood	1 476,00	1 682,00	2 001,00	1 497,00	1 739,00	2 063,00
4M5 461 Solid wood, rustic	1 476,00	1 682,00	2 001,00	1 497,00	1 739,00	2 063,00
4UJ 461 Veneered multiplex **	1 287,00	1 535,00	1 705,00	1 327,00	1 590,00	1 764,00
4YJ 461 Multiplex + HPL laminate *****	1 317,00	1 620,00	1 803,00	1 346,00	1 668,00	1 864,00
4ZJ 461 Multiplex + nanolaminate	1 545,00	1 913,00	2 109,00	1 574,00	1 957,00	2 154,00
American walnut						
Table top options						
4M5 461 Solid wood	2 009,00	2 301,00	2 830,00	2 009,00	2 361,00	2 895,00
4UJ 461 Veneered multiplex **	1 475,00	1 758,00	1 988,00	1 522,00	1 814,00	2 045,00
4YJ 461 Multiplex + HPL laminate *****	1 334,00	1 637,00	1 820,00	1 363,00	1 685,00	1 881,00
4ZJ 461 Multiplex + nanolaminate	1 562,00	1 930,00	2 126,00	1 591,00	1 974,00	2 171,00
<b>SURCHARGES IN € (VAT NOT INCLUDED)</b>						
Beech						
Antique colour	50,00	55,00	61,00	56,00	62,00	69,00
Pigment colours	96,00	106,00	117,00	108,00	120,00	134,00
Oak						
Antique colour						
Pigment colours	96,00	106,00	117,00	108,00	120,00	134,00
<b>TECHNICAL INFORMATION</b>						
Shape of the table top	1	1	1	2/3	2/3	2/3
Table top thickness (mm) - solid wood	25	25	25	25	25	25
Table top thickness (mm) - multiplex	20	20	20	20	20	20
Total height (cm) - solid wood	75,5	75,5	75,5	75,5	75,5	75,5
Total height (cm) - multiplex	75	75	75	75	75	75
Height up to the apron (cm)	73	73	73	73	73	73
Pedestal dimension (cm)	40 × 40	40 × 40	40 × 40	40 × 40	40 × 40	40 × 40
Weight of product (kg) - solid wood	44	52,1	60,5	62,6/61,3	76,5/74,9	90,7/88,8
Weight of product (kg) - multiplex	42,3	49,9	57,7	60,3/59,3	73,6/72,3	87,2/85,6
Volume (m³/pc)	0,653	0,673	0,716	0,653	0,673	0,716
Carton dimensions (cm)	99 × 99 × 8	109 × 109 × 8	129 × 129 × 8	99 × 99 × 8	109 × 109 × 8	129 × 129 × 8
	75 × 75 × 87	75 × 75 × 87	75 × 75 × 87	75 × 75 × 87	75 × 75 × 87	75 × 75 × 87
Bicolour	√	√	√	√	√	√

Shape of the table top: 1 - circle, 2 - square, 3 - spheric square

\*\* Lead time apx 12 weeks.

\*\*\*\*\* The prices are valid for black (L123) and white (L20); other colour finishes are available on request.



p.o.v.

kaschkasch



TYPE	table	table	table	table	table	table
------	-------	-------	-------	-------	-------	-------

TABLE TOP SIZE (CM)	ø 120	ø 130	ø 140	ø 150	120 × 120	130 × 130
---------------------	-------	-------	-------	-------	-----------	-----------

Extension to (cm)

**PRICES IN € (VAT NOT INCLUDED)**

**PRODUCT NUMBER**

Beech

Table top options

4M5 462 Solid wood	1 753,00	2 226,00	2 426,00	2 489,00	1 826,00	2 303,00
--------------------	----------	----------	----------	----------	----------	----------

4LJ 462 Veneered multiplex**	1 553,00				1 621,00	
------------------------------	----------	--	--	--	----------	--

4BJ 462 Multiplex	1 470,00				1 539,00	
-------------------	----------	--	--	--	----------	--

4YJ 462 Multiplex + HPL laminate****	1 784,00				1 853,00	
--------------------------------------	----------	--	--	--	----------	--

4ZJ 462 Multiplex + nanolaminate	2 082,00				2 136,00	
----------------------------------	----------	--	--	--	----------	--

Oak

Table top options

4M5 462 Solid wood	2 034,00	2 611,00	3 165,00	3 229,00	2 105,00	2 701,00
--------------------	----------	----------	----------	----------	----------	----------

4M5 462 Solid wood, rustic	2 034,00	2 611,00	3 165,00	3 229,00	2 105,00	2 701,00
----------------------------	----------	----------	----------	----------	----------	----------

4LJ 462 Veneered multiplex**	1 744,00				1 808,00	
------------------------------	----------	--	--	--	----------	--

4YJ 462 Multiplex + HPL laminate****	1 846,00				1 915,00	
--------------------------------------	----------	--	--	--	----------	--

4ZJ 462 Multiplex + nanolaminate	2 144,00				2 198,00	
----------------------------------	----------	--	--	--	----------	--

American walnut

Table top options

4M5 462 Solid wood	2 886,00	3 253,00	4 028,00	4 093,00	2 960,00	3 350,00
--------------------	----------	----------	----------	----------	----------	----------

4LJ 462 Veneered multiplex**	2 071,00				2 135,00	
------------------------------	----------	--	--	--	----------	--

4YJ 462 Multiplex + HPL laminate****	1 885,00				1 954,00	
--------------------------------------	----------	--	--	--	----------	--

4ZJ 462 Multiplex + nanolaminate	2 183,00				2 237,00	
----------------------------------	----------	--	--	--	----------	--

**SURCHARGES IN € (VAT NOT INCLUDED)**

Beech

Antique colour	76,00	81,00	88,00	95,00	86,00	93,00
----------------	-------	-------	-------	-------	-------	-------

Pigment colours	145,00				165,00	
-----------------	--------	--	--	--	--------	--

Oak

Antique colour

Pigment colours	145,00				165,00	
-----------------	--------	--	--	--	--------	--

**TECHNICAL INFORMATION**

Shape of the table top	1	1	1	1	2/3	2/3
------------------------	---	---	---	---	-----	-----

Table top thickness (mm) - solid wood	25	25	25	25	25	25
---------------------------------------	----	----	----	----	----	----

Table top thickness (mm) - multiplex	20				20	
--------------------------------------	----	--	--	--	----	--

Total height (cm) - solid wood	75,5	75,5	75,5	75,5	75,5	75,5
--------------------------------	------	------	------	------	------	------

Total height (cm) - multiplex	75				75	
-------------------------------	----	--	--	--	----	--

Height up to the apron (cm)	73	73	73	73	73	73
-----------------------------	----	----	----	----	----	----

Pedestal dimension (cm)	52 × 52	52 × 52	52 × 52	52 × 52	52 × 52	52 × 52
-------------------------	---------	---------	---------	---------	---------	---------

Weight of product (kg) - solid wood	39,3	53,3	62,6	82,2	75,6/73,2	90,7/87,8
-------------------------------------	------	------	------	------	-----------	-----------

Weight of product (kg) - multiplex	36,1				71,5/69,5	
------------------------------------	------	--	--	--	-----------	--

Volume (m³/pc)	0,716	0,796	0,796	0,796	0,716	0,796
----------------	-------	-------	-------	-------	-------	-------

Carton dimensions (cm)	129 × 129 × 8	159 × 159 × 8	159 × 159 × 8	159 × 159 × 8	129 × 129 × 8	159 × 159 × 8
------------------------	---------------	---------------	---------------	---------------	---------------	---------------

	75 × 75 × 87	75 × 75 × 87	75 × 75 × 87	75 × 75 × 87	75 × 75 × 87	75 × 75 × 87
--	--------------	--------------	--------------	--------------	--------------	--------------

Bicolour	✓	✓	✓	✓	✓	✓
----------	---	---	---	---	---	---

Shape of the table top: 1 - circle, 2 - square, 3 - spheric square

\*\* Lead time apx 12 weeks.

\*\*\*\* The prices are valid for black (L123) and white (L20); other colour finishes are available on request.

**p.o.v.**

kaschkasch

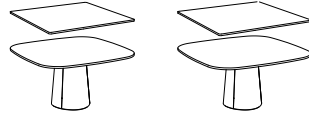

TYPE	table	table
<b>TABLE TOP SIZE (CM)</b>	140 × 140	150 × 150
Extension to (cm)		
<b>PRICES IN € (VAT NOT INCLUDED)</b>		
<b>PRODUCT NUMBER</b>		
Beech		
Table top options		
4M5 462 Solid wood	<b>2 503,00</b>	<b>2 573,00</b>
4UJ 462 Veneered multiplex**		
4BJ 462 Multiplex		
4YJ 462 Multiplex + HPL laminate*****		
4ZJ 462 Multiplex + nanolaminate		
Oak		
Table top options		
4M5 462 Solid wood	<b>3 246,00</b>	<b>3 301,00</b>
4M5 462 Solid wood, rustic	<b>3 246,00</b>	<b>3 301,00</b>
4UJ 462 Veneered multiplex**		
4YJ 462 Multiplex + HPL laminate*****		
4ZJ 462 Multiplex + nanolaminate		
American walnut		
Table top options		
4M5 462 Solid wood	<b>4 111,00</b>	<b>4 180,00</b>
4UJ 462 Veneered multiplex**		
4YJ 462 Multiplex + HPL laminate*****		
4ZJ 462 Multiplex + nanolaminate		
<b>SURCHARGES IN € (VAT NOT INCLUDED)</b>		
Beech		
Antique colour	<b>101,00</b>	<b>109,00</b>
Pigment colours		
Oak		
Antique colour		
Pigment colours		
<b>TECHNICAL INFORMATION</b>		
Shape of the table top	2/3	2/3
Table top thickness (mm) - solid wood	25	25
Table top thickness (mm) - multiplex		
Total height (cm) - solid wood	75,5	75,5
Total height (cm) - multiplex		
Height up to the apron (cm)	73	73
Pedestal dimension (cm)	52 × 52	52 × 52
Weight of product (kg) - solid wood	106,1/103	132/128,6
Weight of product (kg) - multiplex		
Volume (m³/pc)	0,796	0,796
Carton dimensions (cm)	159 × 159 × 8	159 × 159 × 8
	75 × 75 × 87	75 × 75 × 87
Bicolour	√	√

Shape of the table top: 1 - circle, 2 - square, 3 - spheric square

\*\* Lead time apx 12 weeks.

\*\*\*\*\* The prices are valid for black (L123) and white (L20); other colour finishes are available on request.

p.o.v.

kaschkasch

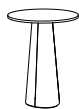

TYPE	bar table	bar table	bar table	bar table	bar table	bar table
------	-----------	-----------	-----------	-----------	-----------	-----------

TABLE TOP SIZE (CM)	ø 70	ø 80	ø 90	ø 100	70 × 70	80 × 80
---------------------	------	------	------	-------	---------	---------

Extension to (cm)

**PRICES IN € (VAT NOT INCLUDED)**

**PRODUCT NUMBER**

Beech

Table top options

4M5 463 Solid wood	1 237,00	1 284,00	1 354,00	1 599,00	1 267,00	1 337,00
4LJ 463 Veneered multiplex**	1 187,00	1 225,00	1 282,00	1 515,00	1 210,00	1 259,00
4BJ 463 Multiplex	1 164,00	1 194,00	1 240,00	1 455,00	1 187,00	1 228,00
4YJ 463 Multiplex + HPL laminate****	1 309,00	1 315,00	1 350,00	1 656,00	1 322,00	1 333,00
4ZJ 463 Multiplex + nanolaminate	1 534,00	1 544,00	1 578,00	1 949,00	1 546,00	1 562,00

Oak

Table top options

4M5 463 Solid wood	1 361,00	1 424,00	1 583,00	1 792,00	1 396,00	1 472,00
4M5 463 Solid wood, rustic	1 361,00	1 424,00	1 583,00	1 792,00	1 396,00	1 472,00
4LJ 463 Veneered multiplex**	1 287,00	1 330,00	1 394,00	1 645,00	1 305,00	1 358,00
4YJ 463 Multiplex + HPL laminate****	1 383,00	1 389,00	1 424,00	1 730,00	1 396,00	1 407,00
4ZJ 463 Multiplex + nanolaminate	1 608,00	1 618,00	1 652,00	2 023,00	1 620,00	1 636,00

American walnut

Table top options

4M5 463 Solid wood	1 691,00	1 837,00	2 144,00	2 439,00	1 726,00	1 881,00
4LJ 463 Veneered multiplex**	1 438,00	1 515,00	1 610,00	1 896,00	1 458,00	1 541,00
4YJ 463 Multiplex + HPL laminate****	1 428,00	1 434,00	1 469,00	1 775,00	1 441,00	1 452,00
4ZJ 463 Multiplex + nanolaminate	1 653,00	1 663,00	1 697,00	2 068,00	1 665,00	1 681,00

**SURCHARGES IN € (VAT NOT INCLUDED)**

Beech						
Antique colour	51,00	55,00	59,00	64,00	54,00	59,00
Pigment colours	96,00	104,00	112,00	122,00	103,00	113,00
Oak						
Antique colour						
Pigment colours	96,00	104,00	112,00	122,00	103,00	113,00

**TECHNICAL INFORMATION**

Shape of the table top	1	1	1	1	2/3	2/3
Table top thickness (mm) - solid wood	25	25	25	25	25	25
Table top thickness (mm) - multiplex	20	20	20	20	20	20
Total height (cm) - solid wood	106,5	106,5	106,5	106,5	106,5	106,5
Total height (cm) - multiplex	106	106	106	106	106	106
Height up to the apron (cm)	104	104	104	104	104	104
Pedestal dimension (cm)	40 × 40	40 × 40	40 × 40	40 × 40	40 × 40	40 × 40
Weight of product (kg) - solid wood	30,4	37,6	40,4	53,5	32,5/31,8	45,5/44,6
Weight of product (kg) - multiplex	29,3	36,3	38,7	51,3	31,1/30,4	43,8/42,9
Volume (m³/pc)	0,822	0,837	0,854	0,874	0,822	0,837
Carton dimensions (cm)	79 × 79 × 8	89 × 89 × 8	99 × 99 × 8	109 × 109 × 8	79 × 79 × 8	89 × 89 × 8
	75 × 75 × 118	75 × 75 × 118	75 × 75 × 118	75 × 75 × 118	75 × 75 × 118	75 × 75 × 118

Bicolour	✓	✓	✓	✓	✓	✓
----------	---	---	---	---	---	---

Shape of the table top: 1 - circle, 2 - square, 3 - spheric square

\*\* Lead time apx 12 weeks.

\*\*\*\* The prices are valid for black (L123) and white (L20); other colour finishes are available on request.

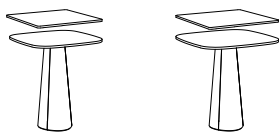

TYPE	bar table	bar table
<b>TABLE TOP SIZE (CM)</b>	90 × 90	100 × 100
Extension to (cm)		
<b>PRICES IN € (VAT NOT INCLUDED)</b>		
<b>PRODUCT NUMBER</b>		
Beech		
Table top options		
4M5 463 Solid wood	1 404,00	1 655,00
4UJ 463 Veneered multiplex **	1 326,00	1 564,00
4BJ 463 Multiplex	1 285,00	1 510,00
4YJ 463 Multiplex + HPL laminate *****	1 376,00	1 701,00
4ZJ 463 Multiplex + nanolaminate	1 604,00	1 990,00
Oak		
Table top options		
4M5 463 Solid wood	1 601,00	1 846,00
4M5 463 Solid wood, rustic	1 601,00	1 846,00
4UJ 463 Veneered multiplex **	1 431,00	1 697,00
4YJ 463 Multiplex + HPL laminate *****	1 450,00	1 775,00
4ZJ 463 Multiplex + nanolaminate	1 678,00	2 064,00
American walnut		
Table top options		
4M5 463 Solid wood	2 141,00	2 496,00
4UJ 463 Veneered multiplex **	1 654,00	1 949,00
4YJ 463 Multiplex + HPL laminate *****	1 495,00	1 820,00
4ZJ 463 Multiplex + nanolaminate	1 723,00	2 109,00
<b>SURCHARGES IN € (VAT NOT INCLUDED)</b>		
Beech		
Antique colour	65,00	71,00
Pigment colours	124,00	136,00
Oak		
Antique colour		
Pigment colours	124,00	136,00
<b>TECHNICAL INFORMATION</b>		
Shape of the table top	2/3	2/3
Table top thickness (mm) - solid wood	25	25
Table top thickness (mm) - multiplex	20	20
Total height (cm) - solid wood	106,5	106,5
Total height (cm) - multiplex	106	106
Height up to the apron (cm)	104	104
Pedestal dimension (cm)	40 × 40	40 × 40
Weight of product (kg) - solid wood	54/52,7	72,9/71,3
Weight of product (kg) - multiplex	51,7/50,7	70/68,7
Volume (m³/pc)	0,854	0,874
Carton dimensions (cm)	99 × 99 × 8	109 × 109 × 8
	75 × 75 × 118	75 × 75 × 118
Bicolour	√	√

Shape of the table top: 1 - circle, 2 - square, 3 - spheric square

\*\* Lead time apx 12 weeks.

\*\*\*\*\* The prices are valid for black (L123) and white (L20); other colour finishes are available on request.

p.o.v.

kaschkasch



TYPE	table **	table **
<b>TABLE TOP SIZE (CM)</b>	120 x 240	120 x 240
Extension to (cm)		
<b>PRICES IN € (VAT NOT INCLUDED)</b>		
<b>PRODUCT NUMBER</b>		
Beech		
Table top options		
4M5 464 Solid wood	3 256,00	3 387,00
4UJ 464 Veneered multiplex **	3 040,00	3 114,00
4BJ 464 Multiplex		
4YJ 464 Multiplex + HPL laminate *****	2 960,00	2 969,00
4ZJ 464 Multiplex + nanolaminate	3 670,00	3 680,00
Oak		
Table top options		
4M5 464 Solid wood	4 427,00	4 528,00
4M5 464 Solid wood, rustic	3 727,00	3 808,00
4UJ 464 Veneered multiplex **	3 237,00	3 308,00
4YJ 464 Multiplex + HPL laminate *****	3 110,00	3 119,00
4ZJ 464 Multiplex + nanolaminate	3 820,00	3 830,00
American walnut		
Table top options		
4M5 464 Solid wood	5 382,00	5 524,00
4UJ 464 Veneered multiplex **	3 545,00	3 626,00
4YJ 464 Multiplex + HPL laminate *****	3 144,00	3 153,00
4ZJ 464 Multiplex + nanolaminate	3 854,00	3 864,00
<b>SURCHARGES IN € (VAT NOT INCLUDED)</b>		
Beech		
Antique colour	157,00	169,00
Pigment colours	303,00	327,00
Oak		
Antique colour		
Pigment colours	303,00	327,00
<b>TECHNICAL INFORMATION</b>		
Shape of the table top	4	5/6
Table top thickness (mm) - solid wood	25	25
Table top thickness (mm) - multiplex	20	20
Total height (cm) - solid wood	75,5	75,5
Total height (cm) - multiplex	75	75
Height up to the apron (cm)	73	73
Pedestal dimension (cm)	40 x 152,5	40 x 152,5
Weight of product (kg) - solid wood	170	175,7/173,2
Weight of product (kg) - multiplex	160,4	165/163
Volume (m³/pc)	1,469	1,469
Carton dimensions (cm)	139 x 269 x 8	139 x 269 x 8
	75 x 75 x 87	75 x 75 x 87
	75 x 75 x 87	75 x 75 x 87
Bicolour	✓	✓

Shape of the table top : 4 - oval, 5 - rectangle, 6 - spheric rectangle

\*\* Lead time apx 12 weeks.

\*\*\*\*\* The prices are valid for black (L123) and white (L20); other colour finishes are available on request.

**p.o.v.**

kaschkasch

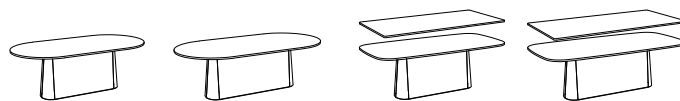

TYPE	table **	table **	table **	table **
<b>TABLE TOP SIZE (CM)</b>	110 × 220	120 × 240	110 × 220	120 × 240
Extension to (cm)				
<b>PRICES IN € (VAT NOT INCLUDED)</b>				
<b>PRODUCT NUMBER</b>				
Beech				
Table top options				
4M5 465 Solid wood	3 355,00	3 544,00	3 445,00	3 675,00
4UJ 465 Veneered multiplex **	3 105,00	3 328,00	3 169,00	3 402,00
4BJ 465 Multiplex				
4YJ 465 Multiplex + HPL laminate *****	3 091,00	3 248,00	3 099,00	3 257,00
4ZJ 465 Multiplex + nanolaminate	3 775,00	3 958,00	3 784,00	3 968,00
Oak				
Table top options				
4M5 465 Solid wood	4 571,00	4 743,00	4 639,00	4 844,00
4M5 465 Solid wood, rustic	4 161,00	4 043,00	4 229,00	4 124,00
4UJ 465 Veneered multiplex **	3 293,00	3 553,00	3 349,00	3 624,00
4YJ 465 Multiplex + HPL laminate *****	3 262,00	3 426,00	3 270,00	3 435,00
4ZJ 465 Multiplex + nanolaminate	3 946,00	4 136,00	3 955,00	4 146,00
American walnut				
Table top options				
4M5 465 Solid wood	5 535,00	5 722,00	5 637,00	5 864,00
4UJ 465 Veneered multiplex **	3 577,00	3 885,00	3 639,00	3 966,00
4YJ 465 Multiplex + HPL laminate *****	3 313,00	3 484,00	3 321,00	3 493,00
4ZJ 465 Multiplex + nanolaminate	3 997,00	4 194,00	4 006,00	4 204,00
<b>SURCHARGES IN € (VAT NOT INCLUDED)</b>				
Beech				
Antique colour	170,00	186,00	180,00	198,00
Pigment colours	304,00	331,00	321,00	355,00
Oak				
Antique colour				
Pigment colours	304,00	331,00	321,00	355,00
<b>TECHNICAL INFORMATION</b>				
Shape of the table top	4	4	5/6	5/6
Table top thickness (mm) - solid wood	25	25	25	25
Table top thickness (mm) - multiplex	20	20	20	20
Total height (cm) - solid wood	75,5	75,5	75,5	75,5
Total height (cm) - multiplex	75	75	75	75
Height up to the apron (cm)	73	73	73	73
Pedestal dimension (cm)	35 × 132,5	35 × 152,5	35 × 132,5	35 × 152,5
Weight of product (kg) - solid wood	110,4	132,1	115,2/113	137,8/135,3
Weight of product (kg) - multiplex	102,4	122,5	106,2/104,5	127,1/125,1
Volume (m³/pc)	1,436	1,658	1,436	1,658
Carton dimensions (cm)	119 × 249 × 8	139 × 269 × 8	119 × 249 × 8	139 × 269 × 8
	75 × 155 × 87	75 × 175 × 87	75 × 155 × 87	75 × 175 × 87
Bicolour	✓	✓	✓	✓

Shape of the table top : 4 - oval, 5 - rectangle, 6 - spheric rectangle

\*\* Lead time apx 12 weeks.

\*\*\*\*\* The prices are valid for black (L123) and white (L20); other colour finishes are available on request.

p.o.v.

kaschkasch



TYPE	table **	table **
<b>TABLE TOP SIZE (CM)</b>	130 × 260	130 × 260
Extension to (cm)		
<b>PRICES IN € (VAT NOT INCLUDED)</b>		
<b>PRODUCT NUMBER</b>		
Beech		
Table top options		
4M5 466 Solid wood	<b>4 400,00</b>	<b>4 539,00</b>
4UJ 466 Veneered multiplex **		
4BJ 466 Multiplex		
4YJ 466 Multiplex + HPL laminate *****		
4ZJ 466 Multiplex + nanolaminat		
Oak		
Table top options		
4M5 466 Solid wood	<b>5 630,00</b>	<b>5 744,00</b>
4M5 466 Solid wood, rustic	<b>4 780,00</b>	<b>4 894,00</b>
4UJ 466 Veneered multiplex **		
4YJ 466 Multiplex + HPL laminate *****		
4ZJ 466 Multiplex + nanolaminat		
American walnut		
Table top options		
4M5 466 Solid wood	<b>7 075,00</b>	<b>7 198,00</b>
4UJ 466 Veneered multiplex **		
4YJ 466 Multiplex + HPL laminate *****		
4ZJ 466 Multiplex + nanolaminat		
<b>SURCHARGES IN € (VAT NOT INCLUDED)</b>		
Beech		
Antique colour	<b>215,00</b>	<b>229,00</b>
Pigment colours		
Oak		
Antique colour		
Pigment colours		
<b>TECHNICAL INFORMATION</b>		
Shape of the table top	4	5/6
Table top thickness (mm) - solid wood	25	25
Table top thickness (mm) - multiplex		
Total height (cm) - solid wood	75,5	75,5
Total height (cm) - multiplex	75	75
Height up to the apron (cm)	73	73
Pedestal dimension (cm)	40 × 172,5	40 × 172,5
Weight of product (kg) - solid wood	144,7	150,9/147,9
Weight of product (kg) - multiplex		
Volume (m³/pc)	1,807	1,807
Carton dimensions (cm)	139 × 269 × 8	139 × 269 × 8
	75 × 195 × 87	75 × 195 × 87
Bicolour	✓	✓

Shape of the table top : 4 - oval, 5 - rectangle, 6 - spheric rectangle

\*\* Lead time apx 12 weeks.

\*\*\*\*\* The prices are valid for black (L123) and white (L20); other colour finishes are available on request.

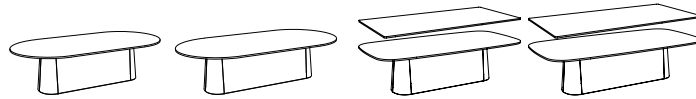

TYPE	table **	table **	table **	table **
<b>TABLE TOP SIZE (CM)</b>	140 × 280	150 × 300	140 × 280	150 × 300
Extension to (cm)				
<b>PRICES IN € (VAT NOT INCLUDED)</b>				
<b>PRODUCT NUMBER</b>				
Beech				
Table top options				
4M5 467 Solid wood	6 024,00	6 289,00	6 187,00	6 481,00
4UJ 467 Veneered multiplex **				
4BJ 467 Multiplex				
4YJ 467 Multiplex + HPL laminate *****				
4ZJ 467 Multiplex + nanolaminate				
Oak				
Table top options				
4M5 467 Solid wood	8 768,00	9 843,00	8 890,00	9 952,00
4M5 467 Solid wood, rustic	7 448,00	7 500,00	7 570,00	7 622,00
4UJ 467 Veneered multiplex **				
4YJ 467 Multiplex + HPL laminate *****				
4ZJ 467 Multiplex + nanolaminate				
American walnut				
Table top options				
4M5 467 Solid wood	10 109,00	10 415,00	10 296,00	10 547,00
4UJ 467 Veneered multiplex **				
4YJ 467 Multiplex + HPL laminate *****				
4ZJ 467 Multiplex + nanolaminate				
<b>SURCHARGES IN € (VAT NOT INCLUDED)</b>				
Beech				
Antique colour	257,00	277,00	273,00	296,00
Pigment colours				
Oak				
Antique colour				
Pigment colours				
<b>TECHNICAL INFORMATION</b>				
Shape of the table top	4	4	5/6	5/6
Table top thickness (mm) - solid wood	25	25	25	25
Table top thickness (mm) - multiplex				
Total height (cm) - solid wood	75,5	75,5	75,5	75,5
Total height (cm) - multiplex	75	75	75	75
Height up to the apron (cm)	73	73	73	73
Pedestal dimension (cm)	52 × 192,5	52 × 212,5	52 × 192,5	52 × 212,5
Weight of product (kg) - solid wood	162,7	196	171,1/167,3	205,7/201,2
Weight of product (kg) - multiplex				
Volume (m³/pc)	2,061	2,210	2,061	2,210
Carton dimensions (cm)	159 × 309 × 8	159 × 309 × 8	159 × 309 × 8	159 × 309 × 8
	75 × 215 × 87	75 × 235 × 87	75 × 215 × 87	75 × 235 × 87
Bicolour	✓	✓	✓	✓

Shape of the table top : 4 - oval, 5 - rectangle, 6 - spheric rectangle

\*\* Lead time apx 12 weeks.

\*\*\*\*\* The prices are valid for black (L123) and white (L20); other colour finishes are available on request.



p.o.v.

kaschkasch

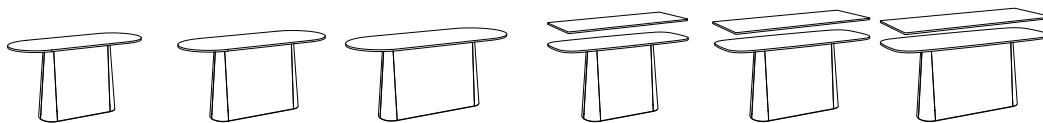

TYPE	bar table **	bar table **	bar table **	bar table **	bar table **	bar table **
------	--------------	--------------	--------------	--------------	--------------	--------------

TABLE TOP SIZE (CM)	80 × 200	90 × 220	100 × 240	80 × 200	90 × 220	100 × 240
---------------------	----------	----------	-----------	----------	----------	-----------

Extension to (cm)

**PRICES IN € (VAT NOT INCLUDED)**

**PRODUCT NUMBER**

Beech

Table top options

4M5 468 Solid wood	3 046,00	3 381,00	3 793,00	3 086,00	3 456,00	3 840,00
4LJ 468 Veneered multiplex **	2 947,00	3 289,00	3 603,00	2 970,00	3 327,00	3 658,00
4BJ 468 Multiplex						
4YJ 468 Multiplex + HPL laminate ****	3 047,00	3 347,00	3 533,00	3 056,00	3 357,00	3 542,00
4ZJ 468 Multiplex + nanolaminate	3 630,00	3 874,00	4 108,00	3 641,00	3 884,00	4 117,00

Oak

Table top options

4M5 468 Solid wood	3 789,00	4 204,00	5 068,00	3 818,00	4 262,00	5 095,00
4M5 468 Solid wood, rustic	3 449,00	3 824,00	4 348,00	3 478,00	3 882,00	4 375,00
4LJ 468 Veneered multiplex **	3 170,00	3 548,00	3 803,00	3 190,00	3 584,00	3 849,00
4YJ 468 Multiplex + HPL laminate ****	3 241,00	3 523,00	3 717,00	3 250,00	3 533,00	3 726,00
4ZJ 468 Multiplex + nanolaminate	3 824,00	4 050,00	4 292,00	3 835,00	4 060,00	4 301,00

American walnut

Table top options

4M5 468 Solid wood	4 713,00	5 177,00	5 720,00	4 751,00	5 289,00	5 758,00
4LJ 468 Veneered multiplex **	3 382,00	3 781,00	4 108,00	3 402,00	3 814,00	4 156,00
4YJ 468 Multiplex + HPL laminate ****	3 381,00	3 653,00	3 865,00	3 390,00	3 663,00	3 874,00
4ZJ 468 Multiplex + nanolaminate	3 964,00	4 180,00	4 440,00	3 975,00	4 190,00	4 449,00

**SURCHARGES IN € (VAT NOT INCLUDED)**

Beech						
Antique colour	182,00	196,00	211,00	187,00	202,00	219,00
Pigment colours	296,00	322,00	351,00	307,00	335,00	367,00
Oak						
Antique colour						
Pigment colours	296,00	322,00	351,00	307,00	335,00	367,00

**TECHNICAL INFORMATION**

Shape of the table top	4	4	4	5/6	5/6	5/6
Table top thickness (mm) - solid wood	25	25	25	25	25	25
Table top thickness (mm) - multiplex	20	20	20	20	20	20
Total height (cm) - solid wood	106,5	106,5	106,5	106,5	106,5	106,5
Total height (cm) - multiplex	106	106	106	106	106	106
Height up to the apron (cm)	104	104	104	104	104	104
Pedestal dimension (cm)	40 × 117,5	40 × 137,5	40 × 157,5	40 × 117,5	40 × 137,5	40 × 157,5
Weight of product (kg) - solid wood	84,9	106,6	128,7	87,8/86	110/107,9	133/130,4
Weight of product (kg) - multiplex	79,2	99,3	120	81,4/80	102,1/100,4	123,4/121,3
Volume (m³/pc)	1,634	1,838	2,105	1,634	1,838	2,105
Carton dimensions (cm)	99 × 229 × 8	99 × 229 × 8	119 × 249 × 8	99 × 229 × 8	99 × 229 × 8	119 × 249 × 8
	75 × 140 × 118	75 × 160 × 118	75 × 180 × 118	75 × 140 × 118	75 × 160 × 118	75 × 180 × 118

Bicolour	✓	✓	✓	✓	✓	✓
----------	---	---	---	---	---	---

Shape of the table top : 4 - oval, 5 - rectangle, 6 - spheric rectangle

\*\* Lead time apx 12 weeks.

\*\*\*\* The prices are valid for black (L123) and white (L20); other colour finishes are available on request.

p.o.v.

kaschkasch



TYPE	table	table	table **	table **	table **	table
<b>TABLE TOP SIZE (CM)</b>	80 × 180	90 × 180	90 × 200	100 × 200	100 × 220	80 × 180
Extension to (cm)						
<b>PRICES IN € (VAT NOT INCLUDED)</b>						
<b>PRODUCT NUMBER</b>						
Beech						
Table top options						
4M5 470 Solid wood	2 464,00	2 479,00	2 908,00	2 989,00	3 015,00	2 514,00
4UJ 470 Veneered multiplex **	2 494,00	2 699,00	2 739,00	2 817,00	2 821,00	2 517,00
4BJ 470 Multiplex						
4YJ 470 Multiplex + HPL laminate *****	2 611,00	2 804,00	2 807,00	2 923,00	2 926,00	2 619,00
4ZJ 470 Multiplex + nanolaminate	3 193,00	3 331,00	3 334,00	3 501,00	3 503,00	3 204,00
Oak						
Table top options						
4M5 470 Solid wood	2 854,00	2 868,00	3 744,00	3 993,00	4 016,00	2 883,00
4M5 470 Solid wood, rustic	2 854,00	2 868,00	3 404,00	3 633,00	3 656,00	2 883,00
4UJ 470 Veneered multiplex **	2 664,00	2 872,00	2 894,00	2 958,00	2 978,00	2 684,00
4YJ 470 Multiplex + HPL laminate *****	2 743,00	2 936,00	2 939,00	3 055,00	3 058,00	2 751,00
4ZJ 470 Multiplex + nanolaminate	3 325,00	3 463,00	3 466,00	3 633,00	3 635,00	3 336,00
American walnut						
Table top options						
4M5 470 Solid wood	3 931,00	4 193,00	4 514,00	4 790,00	5 111,00	3 968,00
4UJ 470 Veneered multiplex **	2 774,00	3 083,00	3 096,00	3 214,00	3 236,00	2 794,00
4YJ 470 Multiplex + HPL laminate *****	2 781,00	2 974,00	2 977,00	3 093,00	3 096,00	2 789,00
4ZJ 470 Multiplex + nanolaminate	3 363,00	3 501,00	3 504,00	3 671,00	3 673,00	3 374,00
<b>SURCHARGES IN € (VAT NOT INCLUDED)</b>						
Beech						
Antique colour	100,00	107,00	114,00	119,00	126,00	105,00
Pigment colours	193,00	205,00	218,00	232,00	246,00	203,00
Oak						
Antique colour						
Pigment colours	193,00	205,00	218,00	232,00	246,00	203,00
<b>TECHNICAL INFORMATION</b>						
Shape of the table top	4	4	4	4	4	5/6
Table top thickness (mm) - solid wood	25	25	25	25	25	25
Table top thickness (mm) - multiplex	20	20	20	20	20	20
Total height (cm) - solid wood	75,5	75,5	75,5	75,5	75,5	75,5
Total height (cm) - multiplex	75	75	75	75	75	75
Height up to the apron (cm)	73	73	73	73	73	73
Pedestal dimension (cm)	35 × 133	35 × 123	35 × 143	35 × 133	35 × 153	35 × 133
Weight of product (kg) - solid wood	103,7	116,5	120,1	123,3	127,3	106,4/104,7
Weight of product (kg) - multiplex	98,4	110,7	113,6	116,2	119,4	100,6/99,2
Volume (m³/pc)	1,334	1,334	1,334	1,398	1,398	1,334
Carton dimensions (cm)	99 × 229 × 8	99 × 229 × 8	99 × 229 × 8	119 × 249 × 8	119 × 249 × 8	99 × 229 × 8
	75 × 75 × 87	75 × 75 × 87	75 × 75 × 87	75 × 75 × 87	75 × 75 × 87	75 × 75 × 87
	75 × 75 × 87	75 × 75 × 87	75 × 75 × 87	75 × 75 × 87	75 × 75 × 87	75 × 75 × 87
Bicolour	✓	✓	✓	✓	✓	✓

Shape of the table top : 4 - oval, 5 - rectangle, 6 - spheric rectangle

\*\* Lead time apx 12 weeks.

\*\*\*\*\* The prices are valid for black (L123) and white (L20); other colour finishes are available on request.

3

p.o.v.

kaschkasch

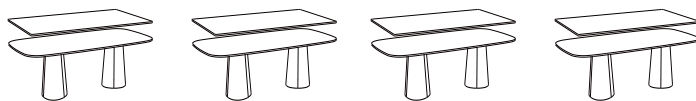

TYPE	table	table **	table **	table **
<b>TABLE TOP SIZE (CM)</b>	90 × 180	90 × 200	100 × 200	100 × 220
Extension to (cm)				
<b>PRICES IN € (VAT NOT INCLUDED)</b>				
<b>PRODUCT NUMBER</b>				
Beech				
Table top options				
4M5 470 Solid wood	2 519,00	3 008,00	3 088,00	3 115,00
4LJ 470 Veneered multiplex **	2 736,00	2 778,00	2 882,00	2 880,00
4BJ 470 Multiplex				
4YJ 470 Multiplex + HPL laminate *****	2 814,00	2 817,00	2 932,00	2 935,00
4ZJ 470 Multiplex + nanolaminate	3 341,00	3 344,00	3 510,00	3 512,00
Oak				
Table top options				
4M5 470 Solid wood	2 897,00	3 818,00	4 066,00	4 090,00
4M5 470 Solid wood, rustic	2 897,00	3 478,00	3 706,00	3 730,00
4LJ 470 Veneered multiplex **	2 905,00	2 928,00	3 015,00	3 034,00
4YJ 470 Multiplex + HPL laminate *****	2 946,00	2 949,00	3 064,00	3 067,00
4ZJ 470 Multiplex + nanolaminate	3 473,00	3 476,00	3 642,00	3 644,00
American walnut				
Table top options				
4M5 470 Solid wood	4 231,00	4 626,00	4 870,00	5 199,00
4LJ 470 Veneered multiplex **	3 116,00	3 129,00	3 286,00	3 297,00
4YJ 470 Multiplex + HPL laminate *****	2 984,00	2 987,00	3 102,00	3 105,00
4ZJ 470 Multiplex + nanolaminate	3 511,00	3 514,00	3 680,00	3 682,00
<b>SURCHARGES IN € (VAT NOT INCLUDED)</b>				
Beech				
Antique colour	112,00	119,00	127,00	135,00
Pigment colours	216,00	230,00	246,00	262,00
Oak				
Antique colour				
Pigment colours	216,00	230,00	246,00	262,00
<b>TECHNICAL INFORMATION</b>				
Shape of the table top	5/6	5/6	5/6	5/6
Table top thickness (mm) - solid wood	25	25	25	25
Table top thickness (mm) - multiplex	20	20	20	20
Total height (cm) - solid wood	75,5	75,5	75,5	75,5
Total height (cm) - multiplex	75	75	75	75
Height up to the apron (cm)	73	73	73	73
Pedestal dimension (cm)	35 × 123	35 × 143	35 × 133	35 × 153
Weight of product (kg) - solid wood	120/118,2	123,6/121,4	127,6/125,7	131,6/129
Weight of product (kg) - multiplex	113,5/112	116,4/114,7	119,6/118,1	122,8/120,7
Volume (m³/pc)	1,334	1,334	1,398	1,398
Carton dimensions (cm)	99 × 229 × 8	99 × 229 × 8	119 × 249 × 8	119 × 249 × 8
	75 × 75 × 87	75 × 75 × 87	75 × 75 × 87	75 × 75 × 87
	75 × 75 × 87	75 × 75 × 87	75 × 75 × 87	75 × 75 × 87
Bicolour	✓	✓	✓	✓

Shape of the table top : 4 - oval, 5 - rectangle, 6 - spheric rectangle

\*\* Lead time apx 12 weeks.

\*\*\*\*\* The prices are valid for black (L123) and white (L20); other colour finishes are available on request.



TYPE	coffee table
<b>TABLE TOP SIZE (CM)</b>	ø 52
Extension to (cm)	
<b>PRICES IN € (VAT NOT INCLUDED)</b>	
<b>PRODUCT NUMBER</b>	
Beech	
Table top options	
4M5 473 Solid wood	952,00
4UJ 473 Veneered multiplex **	944,00
4BJ 473 Multiplex	902,00
4YJ 473 Multiplex + HPL laminate ****	974,00
4ZJ 473 Multiplex + nanolaminate	1 052,00
Oak	
Table top options	
4M5 473 Solid wood	1 018,00
4M5 473 Solid wood, rustic	1 018,00
4UJ 473 Veneered multiplex **	986,00
4YJ 473 Multiplex + HPL laminate ****	1 006,00
4ZJ 473 Multiplex + nanolaminate	1 084,00
American walnut	
Table top options	
4M5 473 Solid wood	1 250,00
4UJ 473 Veneered multiplex **	1 115,00
4YJ 473 Multiplex + HPL laminate ****	1 025,00
4ZJ 473 Multiplex + nanolaminate	1 103,00
<b>SURCHARGES IN € (VAT NOT INCLUDED)</b>	
Beech	
Antique colour	28,00
Pigment colours	51,00
Oak	
Antique colour	
Pigment colours	51,00
<b>TECHNICAL INFORMATION</b>	
Shape of the table top	1
Table top thickness (mm) - solid wood	25
Table top thickness (mm) - multiplex	20
Total height (cm) - solid wood	55
Total height (cm) - multiplex	54,5
Height up to the apron (cm)	52,5
Pedestal dimension (cm)	32 x 32
Weight of product (kg) - solid wood	15,9
Weight of product (kg) - multiplex	15,3
Volume (m³/pc)	0,391
Carton dimensions (cm)	66 x 66 x 78
Bicolour	✓

p.o.v.

kaschkasch



TYPE	coffee table	coffee table	coffee table
TABLE TOP SIZE (CM)	ø 80	ø 90	ø 100
Extension to (cm)			
<b>PRICES IN € (VAT NOT INCLUDED)</b>			
<b>PRODUCT NUMBER</b>			
Beech			
Table top options			
4M5 474 Solid wood	1 085,00	1 155,00	1 400,00
4UJ 474 Veneered multiplex **	1 026,00	1 083,00	1 316,00
4BJ 474 Multiplex	995,00	1 041,00	1 256,00
4YJ 474 Multiplex + HPL laminate *****	1 116,00	1 151,00	1 457,00
4ZJ 474 Multiplex + nanolaminate	1 345,00	1 379,00	1 750,00
Oak			
Table top options			
4M5 474 Solid wood	1 183,00	1 342,00	1 551,00
4M5 474 Solid wood, rustic	1 183,00	1 342,00	1 551,00
4UJ 474 Veneered multiplex **	1 089,00	1 153,00	1 404,00
4YJ 474 Multiplex + HPL laminate *****	1 148,00	1 183,00	1 489,00
4ZJ 474 Multiplex + nanolaminate	1 377,00	1 411,00	1 782,00
American walnut			
Table top options			
4M5 474 Solid wood	1 570,00	1 877,00	2 172,00
4UJ 474 Veneered multiplex **	1 248,00	1 343,00	1 629,00
4YJ 474 Multiplex + HPL laminate *****	1 167,00	1 202,00	1 508,00
4ZJ 474 Multiplex + nanolaminate	1 396,00	1 430,00	1 801,00
<b>SURCHARGES IN € (VAT NOT INCLUDED)</b>			
Beech			
Antique colour	34,00	38,00	43,00
Pigment colours	65,00	73,00	83,00
Oak			
Antique colour			
Pigment colours	65,00	73,00	83,00
<b>TECHNICAL INFORMATION</b>			
Shape of the table top	1	1	1
Table top thickness (mm) - solid wood	25	25	25
Table top thickness (mm) - multiplex	20	20	20
Total height (cm) - solid wood	42	42	42
Total height (cm) - multiplex	41,5	41,5	41,5
Height up to the apron (cm)	39,5	39,5	39,5
Pedestal dimension (cm)	40 × 40	40 × 40	40 × 40
Weight of product (kg) - solid wood	38,6	41,4	54,5
Weight of product (kg) - multiplex	37,2	39,7	52,3
Volume (m³/pc)	0,389	0,406	0,426
Carton dimensions (cm)	66 × 66 × 63	66 × 66 × 63	66 × 66 × 63
	89 × 89 × 8	99 × 99 × 8	109 × 109 × 8
Bicolour	√	√	√

Shape of the table top: 1 - circle

\*\* Lead time apx 12 weeks.

\*\*\*\*\* The prices are valid for black (L123) and white (L20); other colour finishes are available on request.



TYPE	coffee table	coffee table	coffee table
TABLE TOP SIZE (CM)	ø 110	ø 120	ø 130
Extension to (cm)			
<b>PRICES IN € (VAT NOT INCLUDED)</b>			
<b>PRODUCT NUMBER</b>			
Beech			
Table top options			
4M5 475 Solid wood	1 604,00	1 687,00	2 160,00
4LJ 475 Veneered multiplex**	1 406,00	1 487,00	
4BJ 475 Multiplex	1 316,00	1 404,00	
4YJ 475 Multiplex + HPL laminate*****	1 625,00	1 718,00	
4ZJ 475 Multiplex + nanolaminate	1 931,00	2 016,00	
Oak			
Table top options			
4M5 475 Solid wood	1 855,00	1 938,00	2 515,00
4M5 475 Solid wood, rustic	1 855,00	1 938,00	2 515,00
4LJ 475 Veneered multiplex**	1 559,00	1 648,00	
4YJ 475 Multiplex + HPL laminate*****	1 657,00	1 750,00	
4ZJ 475 Multiplex + nanolaminate	1 963,00	2 048,00	
American walnut			
Table top options			
4M5 475 Solid wood	2 686,00	2 770,00	3 137,00
4LJ 475 Veneered multiplex**	1 844,00	1 955,00	
4YJ 475 Multiplex + HPL laminate*****	1 676,00	1 769,00	
4ZJ 475 Multiplex + nanolaminate	1 982,00	2 067,00	
<b>SURCHARGES IN € (VAT NOT INCLUDED)</b>			
Beech			
Antique colour	53,00	59,00	64,00
Pigment colours	101,00	113,00	
Oak			
Antique colour			
Pigment colours	101,00	113,00	
<b>TECHNICAL INFORMATION</b>			
Shape of the table top	1	1	1
Table top thickness (mm) - solid wood	25	25	25
Table top thickness (mm) - multiplex	20	20	
Total height (cm) - solid wood	45	45	45
Total height (cm) - multiplex	44,5	44,5	
Height up to the apron (cm)	42,5	42,5	42,5
Pedestal dimension (cm)	47 × 47	47 × 47	47 × 47
Weight of product (kg) - solid wood	56,4	70	84
Weight of product (kg) - multiplex	53,6	66,8	
Volume (m³/pc)	0,469	0,469	0,549
Carton dimensions (cm)	66 × 66 × 63	66 × 66 × 63	66 × 66 × 63
	129 × 129 × 8	129 × 129 × 8	159 × 159 × 8
Bicolour	✓	✓	✓

Shape of the table top: 1 - circle

\*\* Lead time apx 12 weeks.

\*\*\*\*\* The prices are valid for black (L123) and white (L20); other colour finishes are available on request.

**p.o.v.**  
kaschkasch

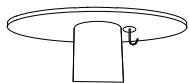

**PRODUCT NUMBER**

**309 495**

Type

hook

**PRICES IN € (VAT NOT INCLUDED)**

Black

**27,00**

**TECHNICAL INFORMATION**

Total width (cm) 6

Total depth (cm) 7

Total height (cm) 7

Weight of product (kg) 0,12

Volume (m<sup>3</sup>/pc) 0,001

Carton dimensions (cm) 8 × 8 × 10





# central leg tables, table tops and bases

## Central leg table bases

Our range includes central leg table bases. They come in metal or wood and they are offered in three different heights: coffee table, dining table and bar table. To complement them, it is possible to order table top in the specified dimensions.

The table top is attached to the central base by a screw in an insert nut. The base is fitted with adjustable levelling screws, which eliminate unevenness of the floor.



Bloom Central



Easy Mix & Fix



Hexagon

## Table top

**M - solid wood top** - the basic material is a solid wood top consisting of wooden prisms glued together (so-called piedrot). Colour differences must be considered for solid wood piedrot, as individual glued prisms may react differently to the finishing materials. Dimension tolerance of  $\pm 3$  mm is defined for solid wood table top, since wood as a natural material naturally reacts to the ambient environment. The natural reactions may also include spontaneous sag of the table top. Table top with the size above 50 cm are therefore supplied with a reinforcement on the bottom side.

**Y - High-pressure laminate** - the basic material is a multiplex board laminated with high-pressure laminate (HPL) with thickness of 0.8 mm. The multiplex consists of layers of veneer applied crosswise onto each other, glued and pressed similarly to plywood. The multiplex is distinguished by a greater thickness of the internal veneers, thus the properties of these pressed boards approach solid wood.

**Z - High-pressure laminate with nanotechnology** - the basic material is a multiplex board coated with high-pressure 0.9 mm laminate with nanotechnology pressed onto the top side. The multiplex consists of layers of veneer applied crosswise onto each other, glued and pressed similarly to plywood. The multiplex is distinguished by

a greater thickness of the internal veneers, thus the properties of these pressed boards approach solid wood. We offer the laminate with nanotechnology in the colours L20 - white and L123 - black.

**M - Finger joint wood board** - A finger joint table top is made by gluing pieces of wood in a cascading fashion, which makes the table top strong and durable. The technique allows us to make table tops in any length.

**B - multiplex top** - the table top is made of plywood from beech veneers, veneered from both sides. Individual layers of veneers are applied crosswise, glued and pressed together.

**U - multiplex top + veneered surface** - the basic material is a multiplex board veneered with beech or oak veneer on the top. It is characterized by higher thickness of the inner veneers, so the properties of the pressed boards approach solid wood. Depending on the shape of the edges, the veneers can also be pressed to the edge or its part. Otherwise, characteristic layers of the pressed veneers are visible on the edge.

! If you combine one of our table bases with a table top that does not come from TON, we cannot guarantee that the base will be sufficiently stable. The weight of your chosen table top must not exceed the weight of the largest table top we have on offer for your chosen base.

! **Y** - High-pressure laminate (HPL) is one of the most resistant table top finishes, particularly suitable for food establishments. It withstands temperatures up to 180°C and damage caused by cutlery, cigarettes and liquids, even alcohol.

! **Z** - High-pressure laminate with nanotechnology is the most advanced generation of laminates. Thanks to its properties, it is suitable for heavy contract use not only in the Horeca sector. It is resistant to high temperatures (hot dishes, cigarette ash), wear (scratching by cutlery), chemicals (cleaning agents), mildew, and food (vinegar, red wine, fruit). It is antistatic, colourfast, water resistant and easy to clean.

! Click on this [link](#) for detailed photographs.

! Multiplex table tops with HPL (marked as Y) and nanolaminate (marked as Z) finish come with natural edge regardless of the HPL, nanolaminate or the base colour. If you are interested in a different colour edge please contact your dealer, who will check this option for you.



## Table top grain

### ■ Multiplex

Veneered multiplex



Multiplex



### ■ Wood board

Finger joint wood board



## Bases

All bases come in B123-black grain finish. Bloom Central pedestal table also comes with the Sandblasted stainless steel base, which has a smooth, matte, frosted surface. Easy Mix & Fix pedestal tables come with the Brushed stainless steel base, which has a half matte, finely brushed surface.



Brushed st. steel



Sandblasted st. steel

## Laminate colour options - High Pressure Laminate finish

L123 black grain  
Egger U999 ST2



L20 white  
Egger W1000 ST9



! The prices of other HPL finishes are available on request.

## Laminate colour options - with nanotechnology

L123 black (nano)  
Fenix NTM 0720

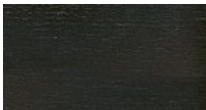

L20 white (nano)  
Fenix NTM 0032

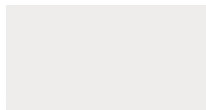

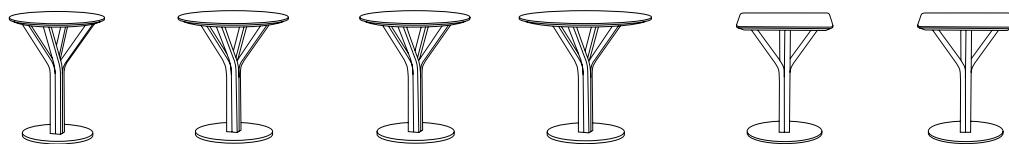

TYPE	table	table	table	table	table	table
TABLE TOP SIZE (CM)	ø 60	ø 70	ø 80	ø 90	60 × 60	70 × 70
Extension to (cm)						

## PRICES IN € (VAT NOT INCLUDED)

### PRODUCT NUMBER

Beech, pedestal black

Table top options

4M5 271 Solid wood	914,00	1 083,00	1 127,00	1 197,00	955,00	1 113,00
4M5 271 Solid wood, finger joint board	905,00	1 071,00	1 110,00	1 173,00	946,00	1 100,00
4UJ 271 Veneered multiplex **	906,00	1 033,00	1 068,00	1 125,00	917,00	1 056,00
4BJ 271 Multiplex	864,00	1 010,00	1 037,00	1 083,00	898,00	1 033,00
4YJ 271 Multiplex + HPL laminate *****	936,00	1 155,00	1 158,00	1 193,00	962,00	1 168,00
4ZJ 271 Multiplex + nanolaminate	1 014,00	1 380,00	1 387,00	1 421,00	1 040,00	1 392,00

Oak, pedestal black

Table top options

4M5 271 Solid wood	1 208,00	1 393,00	1 453,00	1 612,00	1 245,00	1 428,00
4M5 271 Solid wood, rustic	1 208,00	1 393,00	1 453,00	1 612,00	1 245,00	1 428,00
4M5 271 Solid wood, finger joint board	1 173,00	1 344,00	1 410,00	1 461,00	1 209,00	1 380,00
4UJ 271 Veneered multiplex **	1 176,00	1 319,00	1 359,00	1 423,00	1 196,00	1 337,00
4YJ 271 Multiplex + HPL laminate *****	1 196,00	1 415,00	1 418,00	1 453,00	1 222,00	1 428,00
4ZJ 271 Multiplex + nanolaminate	1 274,00	1 640,00	1 647,00	1 681,00	1 300,00	1 652,00

## SURCHARGES IN € (VAT NOT INCLUDED)

Beech						
Antique colour	32,00	35,00	39,00	43,00	34,00	38,00
Pigment colours						
Oak						
Antique colour						
Pigment colours						
Pedestal st. steel sandblasted	109,00	149,00	149,00	149,00	117,00	149,00

## TECHNICAL INFORMATION

Table top thickness (mm) - solid wood	25	25	25	25	25	25
Table top thickness (mm) - multiplex	20	20	20	20	20	20
Total height (cm) - solid wood	75,1	75,1	75,1	75,1	75,1	75,1
Total height (cm) - multiplex	74,6	74,6	74,6	74,6	74,6	74,6
Height up to the apron (cm)	72,6	72,6	72,6	72,6	72,6	72,6
Pedestal black dimension (cm)	ø 44,5	ø 56,5	ø 56,5	ø 56,5	ø 49	ø 56,5
Pedestal st. steel sandblasted dimension (cm)	ø 45	ø 57	ø 57	ø 57	ø 50	ø 57
Weight of product (kg) - solid wood	18,7	26,5	28,5	30,8	22	28,2
Weight of product (kg) - multiplex	18,3	26	27,8	30	21,6	27,7
Volume (m <sup>3</sup> /pc)	0,191	0,211	0,226	0,243	0,193	0,211
Carton dimensions (cm)	69 × 69 × 8	79 × 79 × 8	89 × 89 × 8	99 × 99 × 8	69 × 69 × 8	79 × 79 × 8
	40 × 40 × 74	40 × 40 × 74	40 × 40 × 74	40 × 40 × 74	40 × 40 × 74	40 × 40 × 74
	48 × 48 × 4	60 × 60 × 4	60 × 60 × 4	60 × 60 × 4	53 × 53 × 4	60 × 60 × 4
Bicolour	✓	✓	✓	✓	✓	✓

\*\*\*\*\* Lead time apx 12 weeks.

\*\*\*\*\* The prices are valid for black (L123) and white (L20); other colour finishes are available on request.

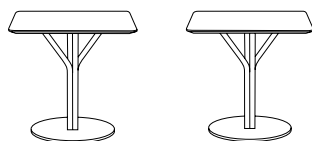

TYPE	table	table
<b>TABLE TOP SIZE (CM)</b>	80 × 80	60 × 80
Extension to (cm)		
<b>PRICES IN € (VAT NOT INCLUDED)</b>		
<b>PRODUCT NUMBER</b>		
Beech, pedestal black		
Table top options		
4M5 271 Solid wood	1 177,00	1 101,00
4M5 271 Solid wood, finger joint board	1 161,00	1 088,00
4UJ 271 Veneered multiplex **	1 099,00	1 070,00
4BJ 271 Multiplex	1 068,00	1 040,00
4YJ 271 Multiplex + HPL laminate *****	1 173,00	1 161,00
4ZJ 271 Multiplex + nanolaminate	1 402,00	1 381,00
Oak, pedestal black		
Table top options		
4M5 271 Solid wood	1 498,00	1 404,00
4M5 271 Solid wood, rustic	1 498,00	1 404,00
4M5 271 Solid wood, finger joint board	1 454,00	1 357,00
4UJ 271 Veneered multiplex **	1 384,00	1 355,00
4YJ 271 Multiplex + HPL laminate *****	1 433,00	1 421,00
4ZJ 271 Multiplex + nanolaminate	1 662,00	1 641,00
<b>SURCHARGES IN € (VAT NOT INCLUDED)</b>		
Beech		
Antique colour	43,00	38,00
Pigment colours		
Oak		
Antique colour		
Pigment colours		
Pedestal st. steel sandblasted	149,00	149,00
<b>TECHNICAL INFORMATION</b>		
Table top thickness (mm) - solid wood	25	25
Table top thickness (mm) - multiplex	20	20
Total height (cm) - solid wood	75,1	75,1
Total height (cm) - multiplex	74,6	74,6
Height up to the apron (cm)	72,6	72,6
Pedestal black dimension (cm)	ø 56,5	ø 56,5
Pedestal st. steel sandblasted dimension (cm)	ø 57	ø 57
Weight of product (kg) - solid wood	30,8	28
Weight of product (kg) - multiplex	30,1	27,4
Volume (m <sup>3</sup> /pc)	0,226	0,226
Carton dimensions (cm)	89 × 89 × 8	89 × 89 × 8
	40 × 40 × 74	40 × 40 × 74
	60 × 60 × 4	60 × 60 × 4
Bicolour	✓	✓

\*\* Lead time apx 12 weeks.

\*\*\*\*\* The prices are valid for black (L123) and white (L20); other colour finishes are available on request.

# bloom central

Arik Levy



TYPE	coffee table	coffee table	coffee table	coffee table	coffee table	coffee table
TABLE TOP SIZE (CM)	ø 55	ø 70	ø 80	ø 90	60 × 60	70 × 70
Extension to (cm)						

## PRICES IN € (VAT NOT INCLUDED)

### PRODUCT NUMBER

Beech, pedestal black

Table top options

4M5 275 Solid wood	848,00	992,00	1 036,00	1 180,00	938,00	1 022,00
4M5 275 Solid wood, finger joint board	839,00	980,00	1 019,00	1 156,00	929,00	1 009,00
4UJ 275 Veneered multiplex**	840,00	942,00	977,00	1 108,00	900,00	965,00
4BJ 275 Multiplex	798,00	919,00	946,00	1 066,00	881,00	942,00
4YJ 275 Multiplex + HPL laminate*****	870,00	1 064,00	1 067,00	1 176,00	945,00	1 077,00
4ZJ 275 Multiplex + nanolaminate	948,00	1 289,00	1 296,00	1 404,00	1 023,00	1 301,00

Oak, pedestal black

Table top options

4M5 275 Solid wood	1 142,00	1 302,00	1 362,00	1 595,00	1 228,00	1 337,00
4M5 275 Solid wood, rustic	1 142,00	1 302,00	1 362,00	1 595,00	1 228,00	1 337,00
4M5 275 Solid wood, finger joint board	1 107,00	1 253,00	1 319,00	1 444,00	1 192,00	1 289,00
4UJ 275 Veneered multiplex**	1 110,00	1 228,00	1 268,00	1 406,00	1 179,00	1 246,00
4YJ 275 Multiplex + HPL laminate*****	1 130,00	1 324,00	1 327,00	1 436,00	1 205,00	1 337,00
4ZJ 275 Multiplex + nanolaminate	1 208,00	1 549,00	1 556,00	1 664,00	1 283,00	1 561,00

## SURCHARGES IN € (VAT NOT INCLUDED)

Beech						
Antique colour	25,00	28,00	32,00	36,00	27,00	31,00
Pigment colours						
Oak						
Antique colour						
Pigment colours						
Pedestal st. steel sandblasted	96,00	117,00	117,00	149,00	117,00	117,00

## TECHNICAL INFORMATION

Table top thickness (mm) - solid wood	25	25	25	25	25	25
Table top thickness (mm) - multiplex	20	20	20	20	20	20
Total height (cm) - solid wood	50,1	50,1	50,1	50,1	50,1	50,1
Total height (cm) - multiplex	49,6	49,6	49,6	49,6	49,6	49,6
Height up to the apron (cm)	47,6	47,6	47,6	47,6	47,6	47,6
Pedestal black dimension (cm)	ø 40,5	ø 49	ø 49	ø 56,5	ø 49	ø 49
Pedestal st. steel sandblasted dimension (cm)	ø 41	ø 50	ø 50	ø 57	ø 50	ø 50
Weight of product (kg) - solid wood	15,3	21,3	23,3	29,6	20,8	23
Weight of product (kg) - multiplex	14,9	20,8	22,6	28,8	20,4	22,5
Volume (m³/pc)	0,107	0,126	0,141	0,162	0,112	0,126
Carton dimensions (cm)	69 × 69 × 8	79 × 79 × 8	89 × 89 × 8	99 × 99 × 8	69 × 69 × 8	79 × 79 × 8
	31 × 31 × 49	31 × 31 × 49	31 × 31 × 49	31 × 31 × 49	31 × 31 × 49	31 × 31 × 49
	44 × 44 × 4	53 × 53 × 4	53 × 53 × 4	60 × 60 × 4	53 × 53 × 4	53 × 53 × 4
Bicolour	✓	✓	✓	✓	✓	✓

\*\* Lead time apx 12 weeks.

\*\*\*\*\* The prices are valid for black (L123) and white (L20); other colour finishes are available on request.



TYPE	coffee table	coffee table	coffee table	coffee table	coffee table	coffee table
<b>TABLE TOP SIZE (CM)</b>	ø 60	ø 70	ø 80	ø 90	60 × 60	70 × 70
Extension to (cm)						
<b>PRICES IN € (VAT NOT INCLUDED)</b>						
<b>PRODUCT NUMBER</b>						
Beech, pedestal black						
Table top options						
4M5 276 Solid wood	885,00	964,00	1 024,00	1 168,00	926,00	1 010,00
4M5 276 Solid wood, finger joint board	876,00	952,00	1 007,00	1 144,00	917,00	997,00
4UJ 276 Veneered multiplex**	877,00	914,00	965,00	1 096,00	888,00	953,00
4BJ 276 Multiplex	835,00	891,00	934,00	1 054,00	869,00	930,00
4YJ 276 Multiplex + HPL laminate*****	907,00	1 036,00	1 055,00	1 164,00	933,00	1 065,00
4ZJ 276 Multiplex + nanolaminate	985,00	1 261,00	1 284,00	1 392,00	1 011,00	1 289,00
Oak, pedestal black						
Table top options						
4M5 276 Solid wood	1 179,00	1 274,00	1 350,00	1 583,00	1 216,00	1 325,00
4M5 276 Solid wood, rustic	1 179,00	1 274,00	1 350,00	1 583,00	1 216,00	1 325,00
4M5 276 Solid wood, finger joint board	1 144,00	1 225,00	1 307,00	1 432,00	1 180,00	1 277,00
4UJ 276 Veneered multiplex**	1 147,00	1 200,00	1 256,00	1 394,00	1 167,00	1 234,00
4YJ 276 Multiplex + HPL laminate*****	1 167,00	1 296,00	1 315,00	1 424,00	1 193,00	1 325,00
4ZJ 276 Multiplex + nanolaminate	1 245,00	1 521,00	1 544,00	1 652,00	1 271,00	1 549,00
<b>SURCHARGES IN € (VAT NOT INCLUDED)</b>						
Beech						
Antique colour	19,00	22,00	26,00	30,00	21,00	25,00
Pigment colours						
Oak						
Antique colour						
Pigment colours						
Pedestal st. steel sandblasted	109,00	109,00	117,00	149,00	117,00	117,00
<b>TECHNICAL INFORMATION</b>						
Table top thickness (mm) - solid wood	25	25	25	25	25	25
Table top thickness (mm) - multiplex	20	20	20	20	20	20
Total height (cm) - solid wood	40,1	40,1	40,1	40,1	40,1	40,1
Total height (cm) - multiplex	39,6	39,6	39,6	39,6	39,6	39,6
Height up to the apron (cm)	37,6	37,6	37,6	37,6	37,6	37,6
Pedestal black dimension (cm)	ø 44,5	ø 44,5	ø 49	ø 56,5	ø 49	ø 49
Pedestal st. steel sandblasted dimension (cm)	ø 45	ø 45	ø 50	ø 57	ø 50	ø 50
Weight of product (kg) - solid wood	17,2	19	23	29,3	20,5	22,7
Weight of product (kg) - multiplex	16,8	18,5	22,3	28,5	20,1	22,2
Volume (m <sup>3</sup> /pc)	0,098	0,112	0,129	0,150	0,100	0,114
Carton dimensions (cm)	69 × 69 × 8	79 × 79 × 8	89 × 89 × 8	99 × 99 × 8	69 × 69 × 8	79 × 79 × 8
	31 × 31 × 39	31 × 31 × 39	31 × 31 × 39	31 × 31 × 39	31 × 31 × 39	31 × 31 × 39
	48 × 48 × 4	48 × 48 × 4	53 × 53 × 4	60 × 60 × 4	53 × 53 × 4	53 × 53 × 4
Bicolour	✓	✓	✓	✓	✓	✓

\*\* Lead time apx 12 weeks.

\*\*\*\*\* The prices are valid for black (L123) and white (L20); other colour finishes are available on request.

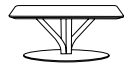
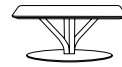
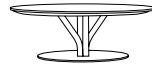
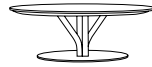
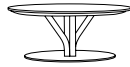
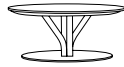

TYPE	coffee table	coffee table	coffee table	coffee table	coffee table	coffee table
<b>TABLE TOP SIZE (CM)</b>	ø 60	ø 70	ø 80	ø 90	60 × 60	70 × 70
Extension to (cm)						
<b>PRICES IN € (VAT NOT INCLUDED)</b>						
<b>PRODUCT NUMBER</b>						
Beech, pedestal black						
Table top options						
4M5 277 Solid wood	904,00	983,00	1 043,00	1 113,00	945,00	1 029,00
4M5 277 Solid wood, finger joint board	895,00	971,00	1 026,00	1 089,00	936,00	1 016,00
4UJ 277 Veneered multiplex**	896,00	933,00	984,00	1 041,00	907,00	972,00
4BJ 277 Multiplex	854,00	910,00	953,00	999,00	888,00	949,00
4YJ 277 Multiplex + HPL laminate*****	926,00	1 055,00	1 074,00	1 109,00	952,00	1 084,00
4ZJ 277 Multiplex + nanolaminate	1 004,00	1 280,00	1 303,00	1 337,00	1 030,00	1 308,00
Oak, pedestal black						
Table top options						
4M5 277 Solid wood	1 198,00	1 293,00	1 369,00	1 528,00	1 235,00	1 344,00
4M5 277 Solid wood, rustic	1 198,00	1 293,00	1 369,00	1 528,00	1 235,00	1 344,00
4M5 277 Solid wood, finger joint board	1 163,00	1 244,00	1 326,00	1 377,00	1 199,00	1 296,00
4UJ 277 Veneered multiplex**	1 166,00	1 219,00	1 275,00	1 339,00	1 186,00	1 253,00
4YJ 277 Multiplex + HPL laminate*****	1 186,00	1 315,00	1 334,00	1 369,00	1 212,00	1 344,00
4ZJ 277 Multiplex + nanolaminate	1 264,00	1 540,00	1 563,00	1 597,00	1 290,00	1 568,00
<b>SURCHARGES IN € (VAT NOT INCLUDED)</b>						
Beech						
Antique colour	18,00	21,00	25,00	29,00	20,00	24,00
Pigment colours						
Oak						
Antique colour						
Pigment colours						
Pedestal st. steel sandblasted	109,00	109,00	117,00	117,00	117,00	117,00
<b>TECHNICAL INFORMATION</b>						
Table top thickness (mm) - solid wood	25	25	25	25	25	25
Table top thickness (mm) - multiplex	20	20	20	20	20	20
Total height (cm) - solid wood	30,1	30,1	30,1	30,1	30,1	30,1
Total height (cm) - multiplex	29,6	29,6	29,6	29,6	29,6	29,6
Height up to the apron (cm)	27,6	27,6	27,6	27,6	27,6	27,6
Pedestal black dimension (cm)	ø 44,5	ø 44,5	ø 49	ø 49	ø 49	ø 49
Pedestal st. steel sandblasted dimension (cm)	ø 45	ø 45	ø 50	ø 50	ø 50	ø 50
Weight of product (kg) - solid wood	16,7	18,6	22,6	24,9	20	22,3
Weight of product (kg) - multiplex	16,3	18,1	21,9	24,1	19,6	21,8
Volume (m³/pc)	0,088	0,102	0,119	0,136	0,090	0,104
Carton dimensions (cm)	69 × 69 × 8	79 × 79 × 8	89 × 89 × 8	99 × 99 × 8	69 × 69 × 8	79 × 79 × 8
	31 × 31 × 29	31 × 31 × 29	31 × 31 × 29	31 × 31 × 29	31 × 31 × 29	31 × 31 × 29
	48 × 48 × 4	48 × 48 × 4	53 × 53 × 4	53 × 53 × 4	53 × 53 × 4	53 × 53 × 4
Bicolour	✓	✓	✓	✓	✓	✓

\*\* Lead time apx 12 weeks.

\*\*\*\*\* The prices are valid for black (L123) and white (L20); other colour finishes are available on request.

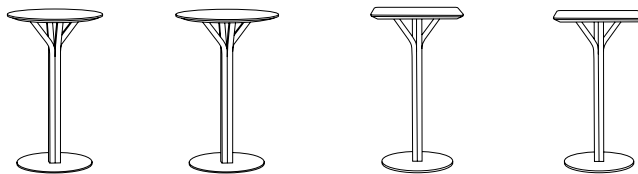

TYPE	bar table	bar table	bar table	bar table
TABLE TOP SIZE (CM)	ø 60	ø 70	60 × 60	70 × 70
Extension to (cm)				
<b>PRICES IN € (VAT NOT INCLUDED)</b>				
<b>PRODUCT NUMBER</b>				
Beech, pedestal black				
Table top options				
4M5 278 Solid wood	998,00	1 077,00	1 023,00	1 107,00
4M5 278 Solid wood, finger joint board	989,00	1 065,00	1 014,00	1 094,00
4UJ 278 Veneered multiplex **	990,00	1 027,00	985,00	1 050,00
4BJ 278 Multiplex	948,00	1 004,00	966,00	1 027,00
4YJ 278 Multiplex + HPL laminate *****	1 020,00	1 149,00	1 030,00	1 162,00
4ZJ 278 Multiplex + nanolaminate	1 098,00	1 374,00	1 108,00	1 386,00
Oak, pedestal black				
Table top options				
4M5 278 Solid wood	1 283,00	1 378,00	1 304,00	1 413,00
4M5 278 Solid wood, rustic	1 283,00	1 378,00	1 304,00	1 413,00
4M5 278 Solid wood, finger joint board	1 248,00	1 329,00	1 268,00	1 365,00
4UJ 278 Veneered multiplex **	1 251,00	1 304,00	1 255,00	1 322,00
4YJ 278 Multiplex + HPL laminate *****	1 271,00	1 400,00	1 281,00	1 413,00
4ZJ 278 Multiplex + nanolaminate	1 349,00	1 625,00	1 359,00	1 637,00
<b>SURCHARGES IN € (VAT NOT INCLUDED)</b>				
Beech				
Antique colour	34,00	37,00	36,00	40,00
Pigment colours				
Oak				
Antique colour				
Pigment colours				
Pedestal st. steel sandblasted	117,00	117,00	117,00	117,00
<b>TECHNICAL INFORMATION</b>				
Table top thickness (mm) - solid wood	25	25	25	25
Table top thickness (mm) - multiplex	20	20	20	20
Total height (cm) - solid wood	105,1	105,1	105,1	105,1
Total height (cm) - multiplex	104,6	104,6	104,6	104,6
Height up to the apron (cm)	102,6	102,6	102,6	102,6
Pedestal black dimension (cm)	ø 49	ø 49	ø 49	ø 49
Pedestal st. steel sandblasted dimension (cm)	ø 50	ø 50	ø 50	ø 50
Weight of product (kg) - solid wood	21,2	23	22,5	24,7
Weight of product (kg) - multiplex	20,8	22,5	22,1	24,2
Volume (m <sup>3</sup> /pc)	0,172	0,186	0,172	0,186
Carton dimensions (cm)	69 × 69 × 8	79 × 79 × 8	69 × 69 × 8	79 × 79 × 8
	31 × 31 × 104	31 × 31 × 104	31 × 31 × 104	31 × 31 × 104
	53 × 53 × 4	53 × 53 × 4	53 × 53 × 4	53 × 53 × 4
Bicolour	✓	✓	✓	✓

\*\* Lead time apx 12 weeks.

\*\*\*\*\* The prices are valid for black (L123) and white (L20); other colour finishes are available on request.



# bloom central

Arik Levy

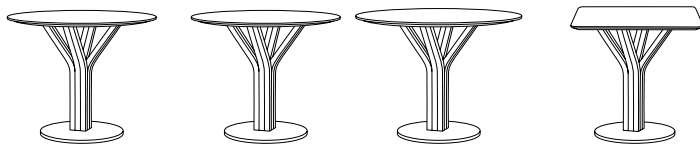

TYPE	table	table	table	table
<b>TABLE TOP SIZE (CM)</b>	ø 100	ø 110	ø 120	90 × 90
Extension to (cm)				
<b>PRICES IN € (VAT NOT INCLUDED)</b>				
<b>PRODUCT NUMBER</b>				
Beech, pedestal black				
Table top options				
4M5 280 Solid wood	1 723,00	1 939,00	2 016,00	1 528,00
4M5 280 Solid wood, finger joint board	1 686,00	1 874,00	1 953,00	1 504,00
4UJ 280 Veneered multiplex **	1 639,00	1 741,00	1 816,00	1 450,00
4BJ 280 Multiplex	1 579,00	1 651,00	1 733,00	1 409,00
4YJ 280 Multiplex + HPL laminate *****	1 780,00	1 960,00	2 047,00	1 500,00
4ZJ 280 Multiplex + nanolaminat	2 073,00	2 266,00	2 345,00	1 728,00
Oak, pedestal black				
Table top options				
4M5 280 Solid wood	2 304,00	2 620,00	2 697,00	2 113,00
4M5 280 Solid wood, rustic	2 304,00	2 620,00	2 697,00	2 113,00
4M5 280 Solid wood, finger joint board	2 185,00	2 387,00	2 463,00	1 984,00
4UJ 280 Veneered multiplex **	2 157,00	2 324,00	2 407,00	1 943,00
4YJ 280 Multiplex + HPL laminate *****	2 242,00	2 422,00	2 509,00	1 962,00
4ZJ 280 Multiplex + nanolaminat	2 535,00	2 728,00	2 807,00	2 190,00
<b>SURCHARGES IN € (VAT NOT INCLUDED)</b>				
Beech				
Antique colour	59,00	65,00	71,00	60,00
Pigment colours				
Oak				
Antique colour				
Pigment colours				
Pedestal st. steel sandblasted	232,00	232,00	232,00	232,00
<b>TECHNICAL INFORMATION</b>				
Table top thickness (mm) - solid wood	25	25	25	25
Table top thickness (mm) - multiplex	20	20	20	20
Total height (cm) - solid wood	75,1	75,1	75,1	75,1
Total height (cm) - multiplex	74,6	74,6	74,6	74,6
Height up to the apron (cm)	72,6	72,6	72,6	72,6
Pedestal black dimension (cm)	ø 63,5	ø 63,5	ø 63,5	ø 63,5
Pedestal st. steel sandblasted dimension (cm)	ø 64	ø 64	ø 64	ø 64
Weight of product (kg) - solid wood	41	43,8	47	41,5
Weight of product (kg) - multiplex	40,1	42,7	45,6	40,5
Volume (m³/pc)	0,302	0,346	0,346	0,283
Carton dimensions (cm)	109 × 109 × 8	129 × 129 × 8	129 × 129 × 8	99 × 99 × 8
	45 × 45 × 74	45 × 45 × 74	45 × 45 × 74	45 × 45 × 74
	67 × 67 × 4	67 × 67 × 4	67 × 67 × 4	67 × 67 × 4
Bicolour	✓	✓	✓	✓

\*\* Lead time apx 12 weeks.

\*\*\*\*\* The prices are valid for black (L123) and white (L20); other colour finishes are available on request.

# easy mix & fix

TON R&D



TYPE	table	table	table
<b>TABLE TOP SIZE (CM)</b>	ø 60	ø 70	ø 80
Extension to (cm)			
<b>PRICES IN € (VAT NOT INCLUDED)</b>			
<b>PRODUCT NUMBER</b>			
Beech, pedestal black/white**			
Table top options			
4M5 628 Solid wood	494,00	573,00	617,00
4M5 628 Solid wood, finger joint board	485,00	561,00	600,00
4UJ 628 Veneered multiplex **	486,00	523,00	558,00
4BJ 628 Multiplex	444,00	500,00	527,00
4YJ 628 Multiplex + HPL laminate *****	516,00	645,00	648,00
4ZJ 628 Multiplex + nanolaminate	594,00	870,00	877,00
Oak, pedestal black/white**			
Table top options			
4M5 628 Solid wood	528,00	623,00	683,00
4M5 628 Solid wood, rustic	528,00	623,00	683,00
4M5 628 Solid wood, finger joint board	493,00	574,00	640,00
4UJ 628 Veneered multiplex **	496,00	549,00	589,00
<b>SURCHARGES IN € (VAT NOT INCLUDED)</b>			
Beech			
Antique colour	11,00	14,00	18,00
Pigment colours	19,00	26,00	34,00
Oak			
Antique colour			
Pigment colours	19,00	26,00	34,00
Pedestal st. steel brushed	132,00	132,00	132,00
<b>TECHNICAL INFORMATION</b>			
Table top thickness (mm) - solid wood	25	25	25
Table top thickness (mm) - multiplex	20	20	20
Total height (cm) - solid wood	75,5	75,5	75,5
Total height (cm) - multiplex	75	75	75
Height up to the apron (cm)	73	73	73
Pedestal black/white dimension (cm)	ø 40,5	ø 40,5	ø 40,5
Pedestal st. steel brushed dimension (cm)	ø 41,0	ø 41,0	ø 41,0
Weight of product (kg) - solid wood	18,4	20,2	22,2
Weight of product (kg) - multiplex	18	19,7	21,5
Volume (m <sup>3</sup> /pc)	0,057	0,071	0,086
Carton dimensions (cm)	69 × 69 × 8	79 × 79 × 8	89 × 89 × 8
	72,4 × 8 × 8	72,4 × 8 × 8	72,4 × 8 × 8
	44 × 44 × 3	44 × 44 × 3	44 × 44 × 3

\*\* Lead time apx 12 weeks.

\*\*\*\*\* The prices are valid for black (L123) and white (L20); other colour finishes are available on request.

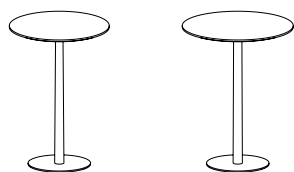

TYPE	bar table	bar table
TABLE TOP SIZE (CM)	ø 60	ø 70
Extension to (cm)		

## PRICES IN € (VAT NOT INCLUDED)

### PRODUCT NUMBER

Beech, pedestal black/white\*\*

Table top options

4M5 629 Solid wood	506,00	585,00
4M5 629 Solid wood, finger joint board	497,00	573,00
4LJ 629 Veneered multiplex**	498,00	535,00
4BJ 629 Multiplex	456,00	512,00
4YJ 629 Multiplex + HPL laminate *****	528,00	657,00
4ZJ 629 Multiplex + nanolaminate	606,00	882,00

Oak, pedestal black/white\*\*

Table top options

4M5 629 Solid wood	540,00	635,00
4M5 629 Solid wood, rustic	540,00	635,00
4M5 629 Solid wood, finger joint board	505,00	586,00
4LJ 629 Veneered multiplex**	508,00	561,00

### SURCHARGES IN € (VAT NOT INCLUDED)

Beech

Antique colour	11,00	14,00
Pigment colours	19,00	26,00

Oak

Antique colour		
Pigment colours	19,00	26,00
Pedestal st. steel brushed	154,00	154,00

### TECHNICAL INFORMATION

Table top thickness (mm) - solid wood	25	25
Table top thickness (mm) - multiplex	20	20
Total height (cm) - solid wood	108,6	108,6
Total height (cm) - multiplex	108,1	108,1
Height up to the apron (cm)	106,1	106,1
Pedestal black/white dimension (cm)	ø 40,5	ø 40,5
Pedestal st. steel brushed dimension (cm)	ø 41,0	ø 41,0
Weight of product (kg) - solid wood	19,2	21
Weight of product (kg) - multiplex	18,8	20,5
Volume (m <sup>3</sup> /pc)	0,060	0,074
Carton dimensions (cm)	69 × 69 × 8	79 × 79 × 8
	105,4 × 8 × 8	105,4 × 8 × 8
	44 × 44 × 3	44 × 44 × 3

\*\* Lead time apx 12 weeks.

\*\*\*\*\* The prices are valid for black (L123) and white (L20); other colour finishes are available on request.



TYPE	table	table	table	table	table
TABLE TOP SIZE (CM)	ø 60	ø 70	ø 80	ø 90	ø 100
Extension to (cm)					

## PRICES IN € (VAT NOT INCLUDED)

### PRODUCT NUMBER

Beech, pedestal black/white\*\*

Table top options

4M5 630 Solid wood	596,00	675,00	719,00	789,00	1 028,00
4M5 630 Solid wood, finger joint board	587,00	663,00	702,00	765,00	991,00
4UJ 630 Veneered multiplex **	588,00	625,00	660,00	717,00	944,00
4BJ 630 Multiplex	546,00	602,00	629,00	675,00	884,00
4YJ 630 Multiplex + HPL laminate *****	618,00	747,00	750,00	785,00	1 085,00
4ZJ 630 Multiplex + nanolaminate	696,00	972,00	979,00	1 013,00	1 378,00

Oak, pedestal black/white\*\*

Table top options

4M5 630 Solid wood	630,00	725,00	785,00	944,00	1 147,00
4M5 630 Solid wood, rustic	630,00	725,00	785,00	944,00	1 147,00
4M5 630 Solid wood, finger joint board	595,00	676,00	742,00	793,00	1 028,00
4UJ 630 Veneered multiplex **	598,00	651,00	691,00	755,00	1 000,00

### SURCHARGES IN € (VAT NOT INCLUDED)

Beech

Antique colour	11,00	14,00	18,00	22,00	27,00
Pigment colours	19,00	26,00	34,00	42,00	52,00

Oak

Antique colour					
Pigment colours	19,00	26,00	34,00	42,00	52,00

Pedestal st. steel brushed

### TECHNICAL INFORMATION

Table top thickness (mm) - solid wood	25	25	25	25	25
Table top thickness (mm) - multiplex	20	20	20	20	20
Total height (cm) - solid wood	75,5	75,5	75,5	75,5	75,5
Total height (cm) - multiplex	75	75	75	75	75
Height up to the apron (cm)	73	73	73	73	73
Pedestal black/white dimension (cm)	ø 56,5	ø 56,5	ø 56,5	ø 56,5	ø 56,5
Pedestal st. steel brushed dimension (cm)					
Weight of product (kg) - solid wood	24,4	26,2	28,2	30,5	33
Weight of product (kg) - multiplex	24	25,7	27,5	29,7	32,1
Volume (m <sup>3</sup> /pc)	0,062	0,076	0,091	0,108	0,128
Carton dimensions (cm)	69 × 69 × 8	79 × 79 × 8	89 × 89 × 8	99 × 99 × 8	109 × 109 × 8
	72,4 × 8 × 8	72,4 × 8 × 8	72,4 × 8 × 8	72,4 × 8 × 8	72,4 × 8 × 8
	58,5 × 58,5 × 3	58,5 × 58,5 × 3	58,5 × 58,5 × 3	58,5 × 58,5 × 3	58,5 × 58,5 × 3

\*\* Lead time apx 12 weeks.

\*\*\*\*\* The prices are valid for black (L123) and white (L20); other colour finishes are available on request.

# easy mix & fix

TON R&D

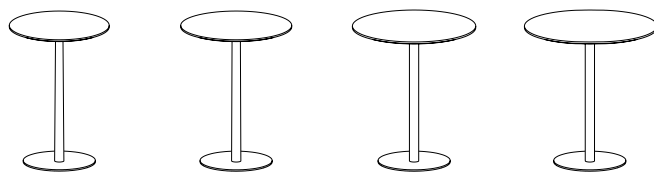

TYPE	bar table	bar table	bar table	bar table
TABLE TOP SIZE (CM)	ø 60	ø 70	ø 80	ø 90
Extension to (cm)				

## PRICES IN € (VAT NOT INCLUDED)

### PRODUCT NUMBER

Beech, pedestal black/white\*\*

Table top options

4M5 631 Solid wood	609,00	688,00	732,00	802,00
4M5 631 Solid wood, finger joint board	600,00	676,00	715,00	778,00
4UJ 631 Veneered multiplex**	601,00	638,00	673,00	730,00
4BJ 631 Multiplex	559,00	615,00	642,00	688,00
4YJ 631 Multiplex + HPL laminate*****	631,00	760,00	763,00	798,00
4ZJ 631 Multiplex + nanolaminate	709,00	985,00	992,00	1 026,00

Oak, pedestal black/white\*\*

Table top options

4M5 631 Solid wood	643,00	738,00	798,00	957,00
4M5 631 Solid wood, rustic	643,00	738,00	798,00	957,00
4M5 631 Solid wood, finger joint board	608,00	689,00	755,00	806,00
4UJ 631 Veneered multiplex**	611,00	664,00	704,00	768,00

### SURCHARGES IN € (VAT NOT INCLUDED)

Beech

Antique colour	11,00	14,00	18,00	22,00
Pigment colours	19,00	26,00	34,00	42,00

Oak

Antique colour				
Pigment colours	19,00	26,00	34,00	42,00

Pedestal st. steel brushed

### TECHNICAL INFORMATION

Table top thickness (mm) - solid wood	25	25	25	25
Table top thickness (mm) - multiplex	20	20	20	20
Total height (cm) - solid wood	108,6	108,6	108,6	108,6
Total height (cm) - multiplex	108,1	108,1	108,1	108,1
Height up to the apron (cm)	106,1	106,1	106,1	106,1
Pedestal black/white dimension (cm)	ø 56,5	ø 56,5	ø 56,5	ø 56,5
Pedestal st. steel brushed dimension (cm)				
Weight of product (kg) - solid wood	25,2	27	29	31,3
Weight of product (kg) - multiplex	24,8	26,5	28,3	30,5
Volume (m <sup>3</sup> /pc)	0,065	0,079	0,094	0,111
Carton dimensions (cm)	69 × 69 × 8	79 × 79 × 8	89 × 89 × 8	99 × 99 × 8
	105,4 × 8 × 8	105,4 × 8 × 8	105,4 × 8 × 8	105,4 × 8 × 8
	58,5 × 58,5 × 3	58,5 × 58,5 × 3	58,5 × 58,5 × 3	58,5 × 58,5 × 3

\*\* Lead time apx 12 weeks.

\*\*\*\*\* The prices are valid for black (L123) and white (L20); other colour finishes are available on request.

# easy mix & fix

TON R&D

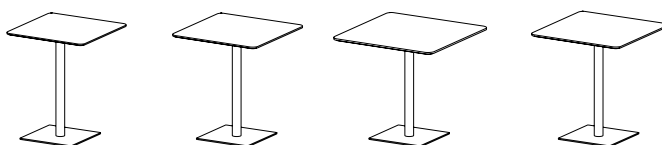

TYPE	table	table	table	table
<b>TABLE TOP SIZE (CM)</b>	60 × 60	70 × 70	80 × 80	60 × 80
Extension to (cm)				
<b>PRICES IN € (VAT NOT INCLUDED)</b>				
<b>PRODUCT NUMBER</b>				
Beech, pedestal black/white**				
Table top options				
4M5 632 Solid wood	522,00	606,00	670,00	594,00
4M5 632 Solid wood, finger joint board	513,00	593,00	654,00	581,00
4UJ 632 Veneered multiplex **	484,00	549,00	592,00	563,00
4BJ 632 Multiplex	465,00	526,00	561,00	533,00
4YJ 632 Multiplex + HPL laminate *****	529,00	661,00	666,00	654,00
4ZJ 632 Multiplex + nanolaminate	607,00	885,00	895,00	874,00
Oak, pedestal black/white**				
Table top options				
4M5 632 Solid wood	552,00	661,00	731,00	637,00
4M5 632 Solid wood, rustic	552,00	661,00	731,00	637,00
4M5 632 Solid wood, finger joint board	516,00	613,00	687,00	590,00
4UJ 632 Veneered multiplex **	503,00	570,00	617,00	588,00
<b>SURCHARGES IN € (VAT NOT INCLUDED)</b>				
Beech				
Antique colour	13,00	17,00	22,00	17,00
Pigment colours	24,00	33,00	43,00	32,00
Oak				
Antique colour				
Pigment colours	24,00	33,00	43,00	32,00
Pedestal st. steel brushed	102,00	102,00	102,00	102,00
<b>TECHNICAL INFORMATION</b>				
Table top thickness (mm) - solid wood	25	25	25	25
Table top thickness (mm) - multiplex	20	20	20	20
Total height (cm) - solid wood	75,5	75,5	75,5	75,5
Total height (cm) - multiplex	75	75	75	75
Height up to the apron (cm)	73	73	73	73
Pedestal black/white dimension (cm)	40,5 × 40,5	40,5 × 40,5	40,5 × 40,5	40,5 × 40,5
Pedestal st. steel brushed dimension (cm)	42,0 × 42,0	42,0 × 42,0	42,0 × 42,0	42,0 × 42,0
Weight of product (kg) - solid wood	22,2	24,4	27	24,3
Weight of product (kg) - multiplex	21,8	23,9	26,3	23,7
Volume (m <sup>3</sup> /pc)	0,057	0,071	0,086	0,086
Carton dimensions (cm)	69 × 69 × 8	79 × 79 × 8	89 × 89 × 8	89 × 89 × 8
	72,4 × 8 × 8	72,4 × 8 × 8	72,4 × 8 × 8	72,4 × 8 × 8
	44 × 44 × 3	44 × 44 × 3	44 × 44 × 3	44 × 44 × 3

\*\* Lead time apx 12 weeks.

\*\*\*\*\* The prices are valid for black (L123) and white (L20); other colour finishes are available on request.

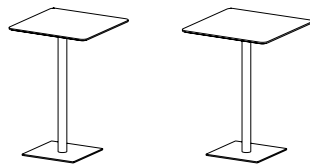

TYPE	bar table	bar table
<b>TABLE TOP SIZE (CM)</b>	60 × 60	70 × 70
Extension to (cm)		
<b>PRICES IN € (VAT NOT INCLUDED)</b>		
<b>PRODUCT NUMBER</b>		
Beech, pedestal black/white**		
Table top options		
4M5 633 Solid wood	535,00	619,00
4M5 633 Solid wood, finger joint board	526,00	606,00
4LJ 633 Veneered multiplex **	497,00	562,00
4BJ 633 Multiplex	478,00	539,00
4YJ 633 Multiplex + HPL laminate *****	542,00	674,00
4ZJ 633 Multiplex + nanolaminate	620,00	898,00
Oak, pedestal black/white**		
Table top options		
4M5 633 Solid wood	565,00	674,00
4M5 633 Solid wood, rustic	565,00	674,00
4M5 633 Solid wood, finger joint board	529,00	626,00
4LJ 633 Veneered multiplex **	516,00	583,00
<b>SURCHARGES IN € (VAT NOT INCLUDED)</b>		
Beech		
Antique colour	13,00	17,00
Pigment colours	24,00	33,00
Oak		
Antique colour		
Pigment colours	24,00	33,00
Pedestal st. steel brushed	123,00	123,00
<b>TECHNICAL INFORMATION</b>		
Table top thickness (mm) - solid wood	25	25
Table top thickness (mm) - multiplex	20	20
Total height (cm) - solid wood	108,6	108,6
Total height (cm) - multiplex	108,1	108,1
Height up to the apron (cm)	106,1	106,1
Pedestal black/white dimension (cm)	40,5 × 40,5	40,5 × 40,5
Pedestal st. steel brushed dimension (cm)	42,0 × 42,0	42,0 × 42,0
Weight of product (kg) - solid wood	23	25,2
Weight of product (kg) - multiplex	22,6	24,7
Volume (m <sup>3</sup> /pc)	0,060	0,074
Carton dimensions (cm)	69 × 69 × 8	79 × 79 × 8
	105,4 × 8 × 8	105,4 × 8 × 8
	44 × 44 × 3	44 × 44 × 3

\*\* Lead time apx 12 weeks.

\*\*\*\*\* The prices are valid for black (L123) and white (L20); other colour finishes are available on request.

# easy mix & fix

TON R&D



TYPE	table	table	table	table	table
<b>TABLE TOP SIZE (CM)</b>	60 × 60	70 × 70	80 × 80	90 × 90	60 × 80
Extension to (cm)					

## PRICES IN € (VAT NOT INCLUDED)

### PRODUCT NUMBER

Beech, pedestal black/white**					
Table top options					
4M5 634 Solid wood	623,00	707,00	771,00	835,00	695,00
4M5 634 Solid wood, finger joint board	614,00	694,00	755,00	811,00	682,00
4UJ 634 Veneered multiplex **	585,00	650,00	693,00	757,00	664,00
4BJ 634 Multiplex	566,00	627,00	662,00	716,00	634,00
4YJ 634 Multiplex + HPL laminate *****	630,00	762,00	767,00	807,00	755,00
4ZJ 634 Multiplex + nanolaminate	708,00	986,00	996,00	1 035,00	975,00
Oak, pedestal black/white**					
Table top options					
4M5 634 Solid wood	653,00	762,00	832,00	958,00	738,00
4M5 634 Solid wood, rustic	653,00	762,00	832,00	958,00	738,00
4M5 634 Solid wood, finger joint board	617,00	714,00	788,00	829,00	691,00
4UJ 634 Veneered multiplex **	604,00	671,00	718,00	788,00	689,00

### SURCHARGES IN € (VAT NOT INCLUDED)

Beech					
Antique colour	13,00	17,00	22,00	28,00	17,00
Pigment colours	24,00	33,00	43,00	54,00	32,00
Oak					
Antique colour					
Pigment colours	24,00	33,00	43,00	54,00	32,00
Pedestal st. steel brushed					

### TECHNICAL INFORMATION

Table top thickness (mm) - solid wood	25	25	25	25	25
Table top thickness (mm) - multiplex	20	20	20	20	20
Total height (cm) - solid wood	75,5	75,5	75,5	75,5	75,5
Total height (cm) - multiplex	75	75	75	75	75
Height up to the apron (cm)	73	73	73	73	73
Pedestal black/white dimension (cm)	55,5 × 55,5	55,5 × 55,5	55,5 × 55,5	55,5 × 55,5	55,5 × 55,5
Pedestal st. steel brushed dimension (cm)					
Weight of product (kg) - solid wood	29,2	31,4	34	37	31,3
Weight of product (kg) - multiplex	28,8	30,9	33,3	36	30,7
Volume (m <sup>3</sup> /pc)	0,062	0,076	0,091	0,108	0,091
Carton dimensions (cm)	69 × 69 × 8	79 × 79 × 8	89 × 89 × 8	99 × 99 × 8	89 × 89 × 8
	72,4 × 8 × 8	72,4 × 8 × 8	72,4 × 8 × 8	72,4 × 8 × 8	72,4 × 8 × 8
	58,5 × 58,5 × 3	58,5 × 58,5 × 3	58,5 × 58,5 × 3	58,5 × 58,5 × 3	58,5 × 58,5 × 3

\*\*\*\*\* The prices are valid for black (L123) and white (L20); other colour finishes are available on request. \*\* Lead time apx 12 weeks.



# easy mix & fix

TON R&D

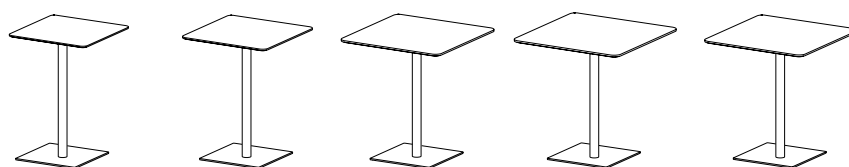

TYPE	bar table	bar table	bar table	bar table	bar table
<b>TABLE TOP SIZE (CM)</b>	60 × 60	70 × 70	80 × 80	90 × 90	60 × 80
Extension to (cm)					
<b>PRICES IN € (VAT NOT INCLUDED)</b>					
<b>PRODUCT NUMBER</b>					
Beech, pedestal black/white**					
Table top options					
4M5 635 Solid wood	636,00	720,00	784,00	848,00	708,00
4M5 635 Solid wood, finger joint board	627,00	707,00	768,00	824,00	695,00
4UJ 635 Veneered multiplex **	598,00	663,00	706,00	770,00	677,00
4BJ 635 Multiplex	579,00	640,00	675,00	729,00	647,00
4YJ 635 Multiplex + HPL laminate ****	643,00	775,00	780,00	820,00	768,00
4ZJ 635 Multiplex + nanolaminate	721,00	999,00	1 009,00	1 048,00	988,00
Oak, pedestal black/white**					
Table top options					
4M5 635 Solid wood	666,00	775,00	845,00	971,00	751,00
4M5 635 Solid wood, rustic	666,00	775,00	845,00	971,00	751,00
4M5 635 Solid wood, finger joint board	630,00	727,00	801,00	842,00	704,00
4UJ 635 Veneered multiplex **	617,00	684,00	731,00	801,00	702,00
<b>SURCHARGES IN € (VAT NOT INCLUDED)</b>					
Beech					
Antique colour	13,00	17,00	22,00	28,00	17,00
Pigment colours	24,00	33,00	43,00	54,00	32,00
Oak					
Antique colour					
Pigment colours	24,00	33,00	43,00	54,00	32,00
Pedestal st. steel brushed					
<b>TECHNICAL INFORMATION</b>					
Table top thickness (mm) - solid wood	25	25	25	25	25
Table top thickness (mm) - multiplex	20	20	20	20	20
Total height (cm) - solid wood	108,6	108,6	108,6	108,6	108,6
Total height (cm) - multiplex	108,1	108,1	108,1	108,1	108,1
Height up to the apron (cm)	106,1	106,1	106,1	106,1	106,1
Pedestal black/white dimension (cm)	55,5 × 55,5	55,5 × 55,5	55,5 × 55,5	55,5 × 55,5	55,5 × 55,5
Pedestal st. steel brushed dimension (cm)					
Weight of product (kg) - solid wood	30	32,2	34,8	37,8	32,1
Weight of product (kg) - multiplex	29,6	31,7	34,1	36,8	31,5
Volume (m <sup>3</sup> /pc)	0,065	0,079	0,094	0,111	0,094
Carton dimensions (cm)	69 × 69 × 8	79 × 79 × 8	89 × 89 × 8	99 × 99 × 8	89 × 89 × 8
	105,4 × 8 × 8	105,4 × 8 × 8	105,4 × 8 × 8	105,4 × 8 × 8	105,4 × 8 × 8
	58,5 × 58,5 × 3	58,5 × 58,5 × 3	58,5 × 58,5 × 3	58,5 × 58,5 × 3	58,5 × 58,5 × 3

\*\* Lead time apx 12 weeks.

\*\*\*\* The prices are valid for black (L123) and white (L20); other colour finishes are available on request.

# easy mix & fix

TON R&D

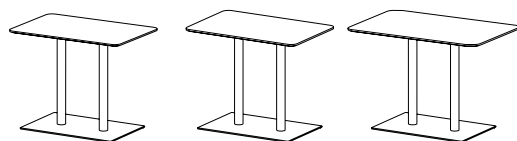

TYPE	table	table	table
<b>TABLE TOP SIZE (CM)</b>	70 × 120	80 × 120	80 × 140
Extension to (cm)			

## PRICES IN € (VAT NOT INCLUDED)

### PRODUCT NUMBER

Beech, pedestal black/white\*\*

Table top options

4M5 636 Solid wood	1 166,00	1 197,00	1 276,00
4M5 636 Solid wood, finger joint board	1 109,00	1 187,00	1 218,00
4UJ 636 Veneered multiplex **	1 074,00	1 111,00	1 168,00
4BJ 636 Multiplex	1 007,00	1 035,00	1 079,00
4YJ 636 Multiplex + HPL laminate *****	1 143,00	1 152,00	1 299,00
4ZJ 636 Multiplex + nanolaminate	1 350,00	1 362,00	1 468,00

Oak, pedestal black/white\*\*

Table top options

4M5 636 Solid wood	1 276,00	1 302,00	1 390,00
4M5 636 Solid wood, rustic	1 276,00	1 302,00	1 390,00
4M5 636 Solid wood, finger joint board	1 131,00	1 161,00	1 249,00
4UJ 636 Veneered multiplex **	1 090,00	1 130,00	1 190,00

### SURCHARGES IN € (VAT NOT INCLUDED)

Beech

Antique colour	29,00	33,00	38,00
Pigment colours	56,00	64,00	74,00

Oak

Antique colour			
Pigment colours	56,00	64,00	74,00

Pedestal st. steel brushed

### TECHNICAL INFORMATION

Table top thickness (mm) - solid wood	25	25	25
Table top thickness (mm) - multiplex	20	20	20
Total height (cm) - solid wood	75,5	75,5	75,5
Total height (cm) - multiplex	75	75	75
Height up to the apron (cm)	73	73	73
Pedestal black/white dimension (cm)	48,5 × 74,0	48,5 × 74,0	48,5 × 74,0
Pedestal st. steel brushed dimension (cm)			
Weight of product (kg) - solid wood	44	46	48,8
Weight of product (kg) - multiplex	43	44,9	47,4
Volume (m <sup>3</sup> /pc)	0,148	0,148	0,148
Carton dimensions (cm)	89 × 149 × 8	89 × 149 × 8	89 × 149 × 8
	72,4 × 8 × 8	72,4 × 8 × 8	72,4 × 8 × 8
	72,4 × 8 × 8	72,4 × 8 × 8	72,4 × 8 × 8
	51 × 76,5 × 3	51 × 76,5 × 3	51 × 76,5 × 3

\*\* Lead time apx 12 weeks.

\*\*\*\*\* The prices are valid for black (L123) and white (L20); other colour finishes are available on request.

# easy mix & fix

TON R&D



TYPE	bar table	bar table	bar table
TABLE TOP SIZE (CM)	70 × 120	80 × 120	80 × 140
Extension to (cm)			

## PRICES IN € (VAT NOT INCLUDED)

### PRODUCT NUMBER

Beech, pedestal black/white\*\*

Table top options

4M5 637 Solid wood	1 191,00	1 222,00	1 301,00
4M5 637 Solid wood, finger joint board	1 134,00	1 212,00	1 243,00
4LJ 637 Veneered multiplex**	1 099,00	1 136,00	1 193,00
4BJ 637 Multiplex	1 032,00	1 060,00	1 104,00
4YJ 637 Multiplex + HPL laminate ****	1 168,00	1 177,00	1 324,00
4ZJ 637 Multiplex + nanolaminate	1 375,00	1 387,00	1 493,00

Oak, pedestal black/white\*\*

Table top options

4M5 637 Solid wood	1 301,00	1 327,00	1 415,00
4M5 637 Solid wood, rustic	1 301,00	1 327,00	1 415,00
4M5 637 Solid wood, finger joint board	1 156,00	1 186,00	1 274,00
4LJ 637 Veneered multiplex**	1 115,00	1 155,00	1 215,00

## SURCHARGES IN € (VAT NOT INCLUDED)

Beech			
Antique colour	29,00	33,00	38,00
Pigment colours	56,00	64,00	74,00
Oak			
Antique colour			
Pigment colours	56,00	64,00	74,00

Pedestal st. steel brushed

## TECHNICAL INFORMATION

Table top thickness (mm) - solid wood	25	25	25
Table top thickness (mm) - multiplex	20	20	20
Total height (cm) - solid wood	108,6	108,6	108,6
Total height (cm) - multiplex	108,1	108,1	108,1
Height up to the apron (cm)	106,1	106,1	106,1
Pedestal black/white dimension (cm)	48,5 × 74,0	48,5 × 74,0	48,5 × 74,0
Pedestal st. steel brushed dimension (cm)			
Weight of product (kg) - solid wood	45,6	47,6	50,4
Weight of product (kg) - multiplex	44,6	46,5	49
Volume (m <sup>3</sup> /pc)	0,153	0,153	0,153
Carton dimensions (cm)	89 × 149 × 8	89 × 149 × 8	89 × 149 × 8
	105,4 × 8 × 8	105,4 × 8 × 8	105,4 × 8 × 8
	105,4 × 8 × 8	105,4 × 8 × 8	105,4 × 8 × 8
	51 × 76,5 × 3	51 × 76,5 × 3	51 × 76,5 × 3

\*\* Lead time apx 12 weeks.

\*\*\*\* The prices are valid for black (L123) and white (L20); other colour finishes are available on request.

# hexagon

Yonoh



TYPE	table	table	table	table	table
<b>TABLE TOP SIZE (CM)</b>	ø 60	ø 70	ø 80	60 × 60	70 × 70
Extension to (cm)					
<b>PRICES IN € (VAT NOT INCLUDED)</b>					
<b>PRODUCT NUMBER</b>					
Beech, pedestal black					
Table top options					
4M5 638 Solid wood	591,00	670,00	714,00	616,00	700,00
4M5 638 Solid wood, finger joint board	582,00	658,00	697,00	607,00	687,00
4UJ 638 Veneered multiplex **	583,00	620,00	655,00	578,00	643,00
4BJ 638 Multiplex	541,00	597,00	624,00	559,00	620,00
4YJ 638 Multiplex + HPL laminate *****	613,00	742,00	745,00	623,00	755,00
4ZJ 638 Multiplex + nanolaminate	691,00	967,00	974,00	701,00	979,00
Oak, pedestal black					
Table top options					
4M5 638 Solid wood	625,00	720,00	780,00	646,00	755,00
4M5 638 Solid wood, rustic	625,00	720,00	780,00	646,00	755,00
4M5 638 Solid wood, finger joint board	590,00	671,00	737,00	610,00	707,00
4UJ 638 Veneered multiplex **	593,00	646,00	686,00	597,00	664,00
<b>SURCHARGES IN € (VAT NOT INCLUDED)</b>					
Beech					
Antique colour	11,00	14,00	18,00	13,00	17,00
Pigment colours	19,00	26,00	34,00	24,00	33,00
Oak					
Antique colour					
Pigment colours	19,00	26,00	34,00	24,00	33,00
Pedestal st. steel brushed					
<b>TECHNICAL INFORMATION</b>					
Table top thickness (mm) - solid wood	25	25	25	25	25
Table top thickness (mm) - multiplex	20	20	20	20	20
Total height (cm) - solid wood	75,7	75,7	75,7	75,7	75,7
Total height (cm) - multiplex	75,2	75,2	75,2	75,2	75,2
Height up to the apron (cm)	73,2	73,2	73,2	73,2	73,2
Pedestal black dimension (cm)	46,8/49,4	46,8/49,4	46,8/49,4	46,8/49,4	46,8/49,4
Pedestal st. steel brushed dimension (cm)					
Weight of product (kg) - solid wood	22,4	24,2	26,2	23,7	25,9
Weight of product (kg) - multiplex	22	23,7	25,5	23,3	25,4
Volume (m <sup>3</sup> /pc)	0,068	0,082	0,097	0,068	0,082
Carton dimensions (cm)	69 × 69 × 8	79 × 79 × 8	89 × 89 × 8	69 × 69 × 8	79 × 79 × 8
	72,4 × 8 × 8	72,4 × 8 × 8	72,4 × 8 × 8	72,4 × 8 × 8	72,4 × 8 × 8
	52 × 52 × 5,6	52 × 52 × 5,6	52 × 52 × 5,6	52 × 52 × 5,6	52 × 52 × 5,6

\*\* Lead time apx 12 weeks.

\*\*\*\*\* The prices are valid for black (L123) and white (L20); other colour finishes are available on request.

# hexagon

Yonoh



TYPE	bar table	bar table	bar table
TABLE TOP SIZE (CM)	ø 60	ø 70	60 x 60
Extension to (cm)			

## PRICES IN € (VAT NOT INCLUDED)

### PRODUCT NUMBER

Beech, pedestal black

Table top options

4M5 639 Solid wood	604,00	683,00	629,00
4M5 639 Solid wood, finger joint board	595,00	671,00	620,00
4LJ 639 Veneered multiplex**	596,00	633,00	591,00
4BJ 639 Multiplex	554,00	610,00	572,00
4YJ 639 Multiplex + HPL laminate*****	626,00	755,00	636,00
4ZJ 639 Multiplex + nanolaminate	704,00	980,00	714,00

Oak, pedestal black

Table top options

4M5 639 Solid wood	638,00	733,00	659,00
4M5 639 Solid wood, rustic	638,00	733,00	659,00
4M5 639 Solid wood, finger joint board	603,00	684,00	623,00
4LJ 639 Veneered multiplex**	606,00	659,00	610,00

## SURCHARGES IN € (VAT NOT INCLUDED)

Beech

Antique colour	11,00	14,00	13,00
Pigment colours	19,00	26,00	24,00

Oak

Antique colour			
Pigment colours	19,00	26,00	24,00

Pedestal st. steel brushed

## TECHNICAL INFORMATION

Table top thickness (mm) - solid wood	25	25	25
Table top thickness (mm) - multiplex	20	20	20
Total height (cm) - solid wood	108,8	108,8	108,8
Total height (cm) - multiplex	108,3	108,3	108,3
Height up to the apron (cm)	106,3	106,3	106,3
Pedestal black dimension (cm)	46,8/49,4	46,8/49,4	46,8/49,4
Pedestal st. steel brushed dimension (cm)			
Weight of product (kg) - solid wood	23,2	25	24,5
Weight of product (kg) - multiplex	22,8	24,5	24,1
Volume (m <sup>3</sup> /pc)	0,071	0,085	0,071
Carton dimensions (cm)	69 x 69 x 8	79 x 79 x 8	69 x 69 x 8
	105,4 x 8 x 8	105,4 x 8 x 8	105,4 x 8 x 8
	52 x 52 x 5,6	52 x 52 x 5,6	52 x 52 x 5,6

\*\* Lead time apx 12 weeks.

\*\*\*\*\* The prices are valid for black (L123) and white (L20); other colour finishes are available on request.

# hexagon

Yonoh

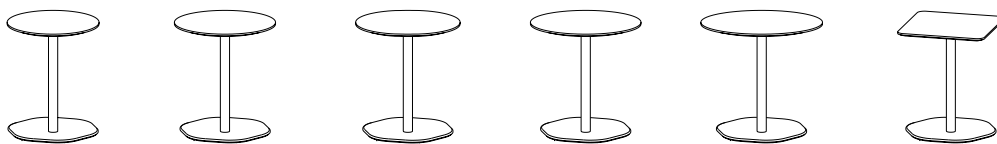

TYPE	table	table	table	table	table	table
<b>TABLE TOP SIZE (CM)</b>	ø 60	ø 70	ø 80	ø 90	ø 100	60 × 60
Extension to (cm)						

## PRICES IN € (VAT NOT INCLUDED)

### PRODUCT NUMBER

Beech, pedestal black

Table top options

4M5 640 Solid wood	797,00	876,00	920,00	990,00	1 229,00	822,00
4M5 640 Solid wood, finger joint board	788,00	864,00	903,00	966,00	1 192,00	813,00
4UJ 640 Veneered multiplex**	789,00	826,00	861,00	918,00	1 145,00	784,00
4BJ 640 Multiplex	747,00	803,00	830,00	876,00	1 085,00	765,00
4YJ 640 Multiplex + HPL laminate*****	819,00	948,00	951,00	986,00	1 286,00	829,00
4ZJ 640 Multiplex + nanolaminate	897,00	1 173,00	1 180,00	1 214,00	1 579,00	907,00

Oak, pedestal black

Table top options

4M5 640 Solid wood	831,00	926,00	986,00	1 145,00	1 348,00	852,00
4M5 640 Solid wood, rustic	831,00	926,00	986,00	1 145,00	1 348,00	852,00
4M5 640 Solid wood, finger joint board	796,00	877,00	943,00	994,00	1 229,00	816,00
4UJ 640 Veneered multiplex**	799,00	852,00	892,00	956,00	1 201,00	803,00

### SURCHARGES IN € (VAT NOT INCLUDED)

Beech

Antique colour	11,00	14,00	18,00	22,00	27,00	13,00
Pigment colours	19,00	26,00	34,00	42,00	52,00	24,00

Oak

Antique colour						
Pigment colours	19,00	26,00	34,00	42,00	52,00	24,00

Pedestal st. steel brushed

### TECHNICAL INFORMATION

Table top thickness (mm) - solid wood	25	25	25	25	25	25
Table top thickness (mm) - multiplex	20	20	20	20	20	20
Total height (cm) - solid wood	75,7	75,7	75,7	75,7	75,7	75,7
Total height (cm) - multiplex	75,2	75,2	75,2	75,2	75,2	75,2
Height up to the apron (cm)	73,2	73,2	73,2	73,2	73,2	73,2
Pedestal black dimension (cm)	54/56,6	54/56,6	54/56,6	54/56,6	54/56,6	54/56,6
Pedestal st. steel brushed dimension (cm)						
Weight of product (kg) - solid wood	28	29,8	31,8	34,1	36,6	29,3
Weight of product (kg) - multiplex	27,6	29,3	31,1	33,3	35,7	28,9
Volume (m <sup>3</sup> /pc)	0,072	0,086	0,101	0,118	0,138	0,072
Carton dimensions (cm)	69 × 69 × 8	79 × 79 × 8	89 × 89 × 8	99 × 99 × 8	109 × 109 × 8	69 × 69 × 8
	72,4 × 8 × 8	72,4 × 8 × 8	72,4 × 8 × 8	72,4 × 8 × 8	72,4 × 8 × 8	72,4 × 8 × 8
	59 × 59 × 5,6	59 × 59 × 5,6	59 × 59 × 5,6	59 × 59 × 5,6	59 × 59 × 5,6	59 × 59 × 5,6

\*\* Lead time apx 12 weeks.

\*\*\*\*\* The prices are valid for black (L123) and white (L20); other colour finishes are available on request.

3

# hexagon

Yonoh



TYPE	table	table	table
TABLE TOP SIZE (CM)	70 × 70	80 × 80	60 × 80
Extension to (cm)			

## PRICES IN € (VAT NOT INCLUDED)

### PRODUCT NUMBER

Beech, pedestal black

Table top options

4M5 640 Solid wood	906,00	970,00	894,00
4M5 640 Solid wood, finger joint board	893,00	954,00	881,00
4UJ 640 Veneered multiplex**	849,00	892,00	863,00
4BJ 640 Multiplex	826,00	861,00	833,00
4YJ 640 Multiplex + HPL laminate*****	961,00	966,00	954,00
4ZJ 640 Multiplex + nanolaminat	1 185,00	1 195,00	1 174,00

Oak, pedestal black

Table top options

4M5 640 Solid wood	961,00	1 031,00	937,00
4M5 640 Solid wood, rustic	961,00	1 031,00	937,00
4M5 640 Solid wood, finger joint board	913,00	987,00	890,00
4UJ 640 Veneered multiplex**	870,00	917,00	888,00

## SURCHARGES IN € (VAT NOT INCLUDED)

Beech			
Antique colour	17,00	22,00	17,00
Pigment colours	33,00	43,00	32,00
Oak			
Antique colour			
Pigment colours	33,00	43,00	32,00
Pedestal st. steel brushed			

## TECHNICAL INFORMATION

Table top thickness (mm) - solid wood	25	25	25
Table top thickness (mm) - multiplex	20	20	20
Total height (cm) - solid wood	75,7	75,7	75,7
Total height (cm) - multiplex	75,2	75,2	75,2
Height up to the apron (cm)	73,2	73,2	73,2
Pedestal black dimension (cm)	54/56,6	54/56,6	54/56,6
Pedestal st. steel brushed dimension (cm)			
Weight of product (kg) - solid wood	31,5	34,1	31,4
Weight of product (kg) - multiplex	31	33,4	30,8
Volume (m <sup>3</sup> /pc)	0,086	0,101	0,101
Carton dimensions (cm)	79 × 79 × 8	89 × 89 × 8	89 × 89 × 8
	72,4 × 8 × 8	72,4 × 8 × 8	72,4 × 8 × 8
	59 × 59 × 5,6	59 × 59 × 5,6	59 × 59 × 5,6

\*\* Lead time apx 12 weeks.

\*\*\*\*\* The prices are valid for black (L123) and white (L20); other colour finishes are available on request.

# hexagon

Yonoh



TYPE	bar table	bar table	bar table	bar table	bar table
TABLE TOP SIZE (CM)	ø 60	ø 70	ø 80	60 × 60	70 × 70
Extension to (cm)					

## PRICES IN € (VAT NOT INCLUDED)

### PRODUCT NUMBER

Beech, pedestal black					
Table top options					
4M5 641 Solid wood	810,00	889,00	933,00	835,00	919,00
4M5 641 Solid wood, finger joint board	801,00	877,00	916,00	826,00	906,00
4UJ 641 Veneered multiplex **	802,00	839,00	874,00	797,00	862,00
4BJ 641 Multiplex	760,00	816,00	843,00	778,00	839,00
4YJ 641 Multiplex + HPL laminate *****	832,00	961,00	964,00	842,00	974,00
4ZJ 641 Multiplex + nanolaminate	910,00	1 186,00	1 193,00	920,00	1 198,00
Oak, pedestal black					
Table top options					
4M5 641 Solid wood	844,00	939,00	999,00	865,00	974,00
4M5 641 Solid wood, rustic	844,00	939,00	999,00	865,00	974,00
4M5 641 Solid wood, finger joint board	809,00	890,00	956,00	829,00	926,00
4UJ 641 Veneered multiplex **	812,00	865,00	905,00	816,00	883,00

### SURCHARGES IN € (VAT NOT INCLUDED)

Beech					
Antique colour	11,00	14,00	18,00	13,00	17,00
Pigment colours	19,00	26,00	34,00	24,00	33,00
Oak					
Antique colour					
Pigment colours	19,00	26,00	34,00	24,00	33,00
Pedestal st. steel brushed					

### TECHNICAL INFORMATION

Table top thickness (mm) - solid wood	25	25	25	25	25
Table top thickness (mm) - multiplex	20	20	20	20	20
Total height (cm) - solid wood	108,8	108,8	108,8	108,8	108,8
Total height (cm) - multiplex	108,3	108,3	108,3	108,3	108,3
Height up to the apron (cm)	106,3	106,3	106,3	106,3	106,3
Pedestal black dimension (cm)	54/56,6	54/56,6	54/56,6	54/56,6	54/56,6
Pedestal st. steel brushed dimension (cm)					
Weight of product (kg) - solid wood	28,8	30,6	32,6	30,1	32,3
Weight of product (kg) - multiplex	28,4	30,1	31,9	29,7	31,8
Volume (m <sup>3</sup> /pc)	0,075	0,089	0,104	0,075	0,089
Carton dimensions (cm)	69 × 69 × 8	79 × 79 × 8	89 × 89 × 8	69 × 69 × 8	79 × 79 × 8
	105,4 × 8 × 8	105,4 × 8 × 8	105,4 × 8 × 8	105,4 × 8 × 8	105,4 × 8 × 8
	59 × 59 × 5,6	59 × 59 × 5,6	59 × 59 × 5,6	59 × 59 × 5,6	59 × 59 × 5,6

\*\*\*\*\* The prices are valid for black (L123) and white (L20); other colour finishes are available on request. \*\* Lead time apx 12 weeks.



# table tops and bases

The direction of the wood grain in the rectangular table tops is the same as the longer side of the table top.

If you combine one of our table bases with a table top that does not come from TON, we cannot guarantee that the base will be sufficiently stable. The weight of your chosen table top must not exceed the weight of the largest table top we have on offer for your chosen base.



# table top

TON R&D

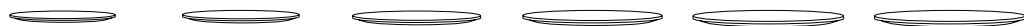

TYPE	table top	table top	table top	table top	table top	table top
<b>TABLE TOP SIZE (CM)</b>	ø 55	ø 60	ø 70	ø 80	ø 90	ø 100
Extension to (cm)						
<b>PRICES IN € (VAT NOT INCLUDED)</b>						
<b>PRODUCT NUMBER</b>						
Beech						
9M5 030 Solid wood	280,00	280,00	359,00	403,00	473,00	712,00
9M5 030 Solid wood, finger joint board	271,00	271,00	347,00	386,00	449,00	675,00
9UJ 030 Veneered multiplex **	272,00	272,00	309,00	344,00	401,00	628,00
9BJ 030 Multiplex	230,00	230,00	286,00	313,00	359,00	568,00
9YJ 030 Multiplex + HPL laminate *****	302,00	302,00	431,00	434,00	469,00	769,00
9ZJ 030 Multiplex + nanolaminate	380,00	380,00	656,00	663,00	697,00	1 062,00
Oak						
9M5 030 Solid wood	314,00	314,00	409,00	469,00	628,00	831,00
9M5 030 Solid wood, rustic	314,00	314,00	409,00	469,00	628,00	831,00
9M5 030 Solid wood, finger joint board	279,00	279,00	360,00	426,00	477,00	712,00
9UJ 030 Veneered multiplex **	282,00	282,00	335,00	375,00	439,00	684,00
<b>SURCHARGES IN € (VAT NOT INCLUDED)</b>						
Beech						
Antique colour	11,00	11,00	14,00	18,00	22,00	27,00
Pigment colours	19,00	19,00	26,00	34,00	42,00	52,00
Oak						
Antique colour						
Pigment colours	19,00	19,00	26,00	34,00	42,00	52,00
Connecting set						
<b>TECHNICAL INFORMATION</b>						
Table top thickness (mm) - solid wood	25	25	25	25	25	25
Table top thickness (mm) - multiplex	20	20	20	20	20	20
Weight of product (kg) - solid wood	4,1	4,9	6,7	8,7	11	13,5
Weight of product (kg) - multiplex	3,7	4,5	6,2	8	10,2	12,6
Volume (m <sup>3</sup> /pc)	0,044	0,044	0,058	0,073	0,090	0,110
Carton dimensions (cm)	69 × 69 × 8	69 × 69 × 8	79 × 79 × 8	89 × 89 × 8	99 × 99 × 8	109 × 109 × 8

\*\* Lead time apx 12 weeks.

\*\*\*\*\* The prices are valid for black (L123) and white (L20); other colour finishes are available on request.

# table top

TON R&D



TYPE	table top	table top	table top	table top	table top
<b>TABLE TOP SIZE (CM)</b>	60 × 60	70 × 70	80 × 80	90 × 90	60 × 80
Extension to (cm)					
<b>PRICES IN € (VAT NOT INCLUDED)</b>					
<b>PRODUCT NUMBER</b>					
Beech					
9M5 030 Solid wood	305,00	389,00	453,00	517,00	377,00
9M5 030 Solid wood, finger joint board	296,00	376,00	437,00	493,00	364,00
9UJ 030 Veneered multiplex **	267,00	332,00	375,00	439,00	346,00
9BJ 030 Multiplex	248,00	309,00	344,00	398,00	316,00
9YJ 030 Multiplex + HPL laminate *****	312,00	444,00	449,00	489,00	437,00
9ZJ 030 Multiplex + nanolaminate	390,00	668,00	678,00	717,00	657,00
Oak					
9M5 030 Solid wood	335,00	444,00	514,00	640,00	420,00
9M5 030 Solid wood, rustic	335,00	444,00	514,00	640,00	420,00
9M5 030 Solid wood, finger joint board	299,00	396,00	470,00	511,00	373,00
9UJ 030 Veneered multiplex **	286,00	353,00	400,00	470,00	371,00
<b>SURCHARGES IN € (VAT NOT INCLUDED)</b>					
Beech					
Antique colour	13,00	17,00	22,00	28,00	17,00
Pigment colours	24,00	33,00	43,00	54,00	32,00
Oak					
Antique colour					
Pigment colours	24,00	33,00	43,00	54,00	32,00
Connecting set					
<b>TECHNICAL INFORMATION</b>					
Table top thickness (mm) - solid wood	25	25	25	25	25
Table top thickness (mm) - multiplex	20	20	20	20	20
Weight of product (kg) - solid wood	6,2	8,4	11	14	8,3
Weight of product (kg) - multiplex	5,8	7,9	10,3	13	7,7
Volume (m³/pc)	0,044	0,058	0,073	0,090	0,073
Carton dimensions (cm)	69 × 69 × 8	79 × 79 × 8	89 × 89 × 8	99 × 99 × 8	89 × 89 × 8

\*\* Lead time apx 12 weeks.

\*\*\*\*\* The prices are valid for black (L123) and white (L20); other colour finishes are available on request.

# table top

TON R&D



TYPE	table top	table top	table top
<b>TABLE TOP SIZE (CM)</b>	70 × 120	80 × 120	80 × 140
Extension to (cm)			
<b>PRICES IN € (VAT NOT INCLUDED)</b>			
<b>PRODUCT NUMBER</b>			
Beech			
9M5 031 Solid wood	728,00	759,00	838,00
9M5 031 Solid wood, finger joint board	671,00	749,00	780,00
9UJ 031 Veneered multiplex **	636,00	673,00	730,00
9BJ 031 Multiplex	569,00	597,00	641,00
9YJ 031 Multiplex + HPL laminate *****	705,00	714,00	861,00
9ZJ 031 Multiplex + nanolaminate	912,00	924,00	1 030,00
Oak			
9M5 031 Solid wood	838,00	864,00	952,00
9M5 031 Solid wood, rustic	838,00	864,00	952,00
9M5 031 Solid wood, finger joint board	693,00	723,00	811,00
9UJ 031 Veneered multiplex **	652,00	692,00	752,00
<b>SURCHARGES IN € (VAT NOT INCLUDED)</b>			
Beech			
Antique colour	29,00	33,00	38,00
Pigment colours	56,00	64,00	74,00
Oak			
Antique colour			
Pigment colours	56,00	64,00	74,00
Connecting set			
<b>TECHNICAL INFORMATION</b>			
Table top thickness (mm) - solid wood	25	25	25
Table top thickness (mm) - multiplex	20	20	20
Weight of product (kg) - solid wood	14,5	16,5	19,3
Weight of product (kg) - multiplex	13,5	15,4	17,9
Volume (m³/pc)	0,122	0,122	0,122
Carton dimensions (cm)	89 × 149 × 8	89 × 149 × 8	89 × 149 × 8

\*\* Lead time apx 12 weeks.

\*\*\*\*\* The prices are valid for black (L123) and white (L20); other colour finishes are available on request.

# bloom central – bases

Arik Levy

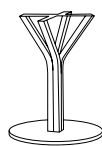
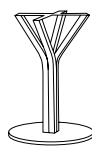
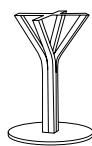

PRODUCT NUMBER	429 271	429 271	429 271	429 275	429 275	429 275
Type	table base	table base	table base	table base	table base	table base
<b>FOR TABLE TOP DIMENSION (CM)</b>						
Min.	ø 60	60 × 60	ø 70, 70 × 70	ø 55	ø 70, 60 × 60	ø 90
Max.	ø 60	60 × 60	ø 90, 80 × 80	ø 55	ø 80, 70 × 70	ø 90
<b>PRICES IN € (VAT NOT INCLUDED)</b>						
Beech, pedestal black	634,00	650,00	724,00	568,00	633,00	707,00
Oak, pedestal black	894,00	910,00	984,00	828,00	893,00	967,00
<b>SURCHARGES IN € (VAT NOT INCLUDED)</b>						
Beech						
Antique colour	21,00	21,00	21,00	14,00	14,00	14,00
Pigment colours						
Oak						
Antique colour						
Pigment colours						
Pedestal st. steel sandblasted	109,00	117,00	149,00	96,00	117,00	149,00
<b>TECHNICAL INFORMATION</b>						
Table base height (cm)	72,6	72,6	72,6	47,6	47,6	47,6
Pedestal black dimension (cm)	ø 44,5	ø 49	ø 56,5	ø 40,5	ø 49	ø 56,5
Pedestal st. steel sandblasted dimension (cm)	ø 45	ø 50	ø 57	ø 41	ø 50	ø 57
Weight of product (kg)	13,8	15,8	19,8	11,2	14,6	18,6
Volume (m <sup>3</sup> /pc)	0,146	0,148	0,152	0,062	0,067	0,07
Carton dimensions (cm)	40 × 40 × 74	40 × 40 × 74	40 × 40 × 74	31 × 31 × 49	31 × 31 × 49	31 × 31 × 49
	48 × 48 × 4	53 × 53 × 4	60 × 60 × 4	44 × 44 × 4	53 × 53 × 4	60 × 60 × 4

3

# bloom central – bases

Arik Levy

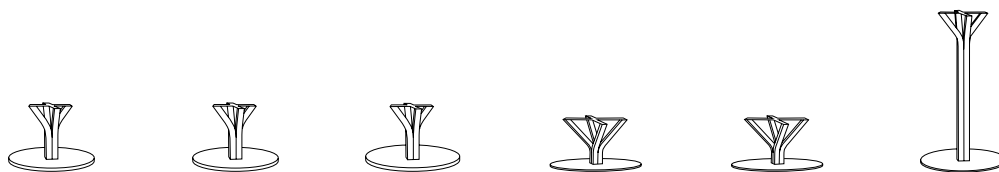

PRODUCT NUMBER	429 276	429 276	429 276	429 277	429 277	429 278
Type	table base	table base	table base	table base	table base	table base

## FOR TABLE TOP DIMENSION (CM)

Min.	ø 60	ø 80, 60 × 60	ø 90	ø 60	ø 80, 60 × 60	ø 60, 60 × 60
Max.	ø 70	ø 80, 70 × 70	ø 90	ø 70	ø 90, 70 × 70	ø 70, 70 × 70

## PRICES IN € (VAT NOT INCLUDED)

Beech, pedestal black	605,00	621,00	695,00	624,00	640,00	718,00
Oak, pedestal black	865,00	881,00	955,00	884,00	900,00	969,00

## SURCHARGES IN € (VAT NOT INCLUDED)

Beech						
Antique colour	8,00	8,00	8,00	7,00	7,00	23,00
Pigment colours						
Oak						
Antique colour						
Pigment colours						
Pedestal st. steel sandblasted	109,00	117,00	149,00	109,00	117,00	117,00

## TECHNICAL INFORMATION

Table base height (cm)	37,6	37,6	37,6	27,6	27,6	102,6
Pedestal black dimension (cm)	ø 44,5	ø 49	ø 56,5	ø 44,5	ø 49	ø 49
Pedestal st. steel sandblasted dimension (cm)	ø 45	ø 50	ø 57	ø 45	ø 50	ø 50
Weight of product (kg)	12,3	14,3	18,3	11,9	13,9	16,3
Volume (m <sup>3</sup> /pc)	0,054	0,056	0,06	0,043	0,045	0,128
Carton dimensions (cm)	31 × 31 × 39	31 × 31 × 39	31 × 31 × 39	31 × 31 × 29	31 × 31 × 29	31 × 31 × 104
	48 × 48 × 4	53 × 53 × 4	60 × 60 × 4	48 × 48 × 4	53 × 53 × 4	53 × 53 × 4

# easy mix & fix – bases

TON R&D

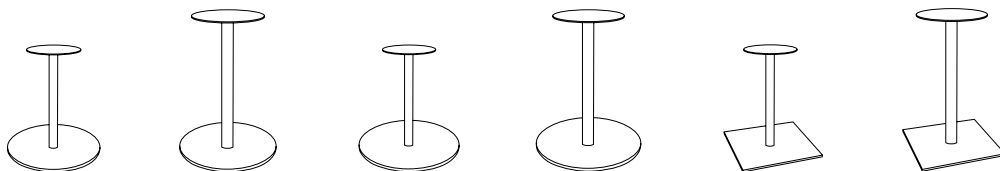

PRODUCT NUMBER	429 628	429 629	429 630	429 631	429 632	429 633
Type	table base	table base	table base	table base	table base	table base
<b>FOR TABLE TOP DIMENSION (CM)</b>						
Min.	ø 60	ø 60	ø 60	ø 60	60 × 60	60 × 60
Max.	ø 80	ø 70	ø 100	ø 90	80 × 80	70 × 70
<b>PRICES IN € (VAT NOT INCLUDED)</b>						
Pedestal black/white**	214,00	226,00	316,00	329,00	217,00	230,00
<b>SURCHARGES IN € (VAT NOT INCLUDED)</b>						
Pedestal st. steel brushed	132,00	154,00			102,00	123,00
<b>TECHNICAL INFORMATION</b>						
Table base height (cm)	73	106,1	73	106,1	73	106,1
Pedestal black/white dimension (cm)	ø 40,5	ø 40,5	ø 56,5	ø 56,5	40,5 × 40,5	40,5 × 40,5
Pedestal st. steel brushed dimension (cm)	ø 41,0	ø 41,0			42,0 × 42,0	42,0 × 42,0
Weight of product (kg)	13,5	14,3	19,5	20,3	16	16,8
Volume (m <sup>3</sup> /pc)	0,013	0,016	0,018	0,021	0,013	0,016
Carton dimensions (cm)	72,4 × 8 × 8	105,4 × 8 × 8	72,4 × 8 × 8	105,4 × 8 × 8	72,4 × 8 × 8	105,4 × 8 × 8
	44 × 44 × 3	44 × 44 × 3	58,5 × 58,5 × 3	58,5 × 58,5 × 3	44 × 44 × 3	44 × 44 × 3



# easy mix & fix – bases

TON R&D

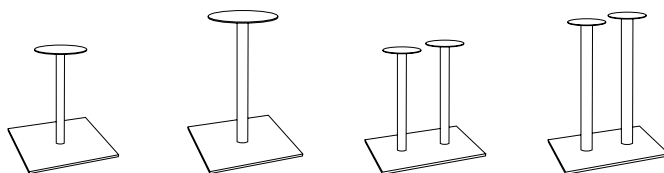

PRODUCT NUMBER	429 634	429 635	429 636	429 637
Type	table base	table base	table base	table base
<b>FOR TABLE TOP DIMENSION (CM)</b>				
Min.	60 × 60	60 × 60	60 × 90	60 × 90
Max.	100 × 100	90 × 90	90 × 150	80 × 140
<b>PRICES IN € (VAT NOT INCLUDED)</b>				
Pedestal black/white**	318,00	331,00	438,00	463,00
<b>SURCHARGES IN € (VAT NOT INCLUDED)</b>				
Pedestal st. steel brushed				
<b>TECHNICAL INFORMATION</b>				
Table base height (cm)	73	106,1	73	106,1
Pedestal black/white dimension (cm)	55,5 × 55,5	55,5 × 55,5	48,5 × 74,0	48,5 × 74,0
Pedestal st. steel brushed dimension (cm)				
Weight of product (kg)	23	23,8	29,5	31,1
Volume (m³/pc)	0,018	0,021	0,026	0,031
Carton dimensions (cm)	72,4 × 8 × 8	105,4 × 8 × 8	72,4 × 8 × 8	105,4 × 8 × 8
	58,5 × 58,5 × 3	58,5 × 58,5 × 3	72,4 × 8 × 8	105,4 × 8 × 8
			51 × 76,5 × 3	51 × 76,5 × 3

# hexagon – bases

Yonoh

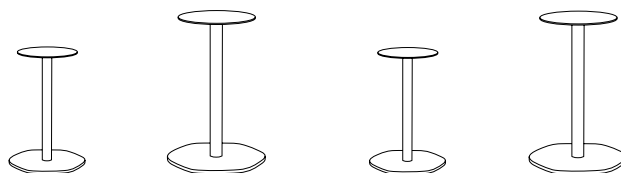

PRODUCT NUMBER	429 638	429 639	429 640	429 641
Type	table base	table base	table base	table base
<b>FOR TABLE TOP DIMENSION (CM)</b>				
Min.	ø 60, 60 × 60	ø 60, 60 × 60	ø 60, 60 × 60	ø 60, 60 × 60
Max.	ø 80, 70 × 70	ø 70, 60 × 60	ø 100, 80 × 80	ø 80, 70 × 70
<b>PRICES IN € (VAT NOT INCLUDED)</b>				
Pedestal black	311,00	324,00	517,00	530,00
<b>SURCHARGES IN € (VAT NOT INCLUDED)</b>				
Pedestal st. steel brushed				
<b>TECHNICAL INFORMATION</b>				
Table base height (cm)	73,2	106,3	73,2	106,3
Pedestal black dimension (cm)	46,8/49,4	46,8/49,4	54/56,6	54/56,6
Pedestal st. steel brushed dimension (cm)				
Weight of product (kg)	17,5	18,3	23,1	23,9
Volume (m³/pc)	0,024	0,027	0,028	0,031
Carton dimensions (cm)	72,4 × 8 × 8	105,4 × 8 × 8	72,4 × 8 × 8	105,4 × 8 × 8
	52 × 52 × 5,6	52 × 52 × 5,6	59 × 59 × 5,6	59 × 59 × 5,6



**benches**

# diner

The simple construction made of solid wood and smooth upholstery make Diner benches timeless elegant. Due to their dimensions and variability, Diner benches can be placed not only in public premises, restaurants or hotels, but also at homes. The collection consists of straight modules, end-of-row modules, two types of corner benches, a side table and a cushion. Besides the cost-effective modular system, the length of straight modules can be adjusted to your needs. We offer all units in three heights of backrest, which is ergonomically shaped. We also offer some modules in bar height. The sitting comfort is provided by the structure of foam.

Wooden parts in both beech and oak version can be finished in all colours from our collection. By default, all units have upholstered both front and back side of the backrest, so they can be placed anywhere in space. Benches are provided with adjustable levelling feet eliminating prospective unevenness of the floor and protecting the material from damages.

! Please note that dimensions of the benches are given without levelling screws. The levelling screws can thus additionally increase the overall height and the seat height of the Diner benches by up to 20 mm (depending on the floor unevenness).

! Please note that the Diner bench is not available in aniline or semi-aniline leather. Leather does not come in large enough lengths to cover the bench without visible seams, and seamless upholstery is important to the overall look of this product.

## ■ Bench modular system

We offer the units of bench modular system in pre-prepared lengths of 85, 95, 105 and 125 cm. Individual modules can be freely combined both in respect to their lengths and to their heights. In the price list, the price is given for the whole unit.

## ■ Benches made to measure

The dimensions of individual units of benches made to measure range between 85 and 125 cm. In the price list, the price is given per 1 running meter.



Diner 383 539 – Bench made to measure  
Diner 3S3 539 – Length 85/95/105/125



Diner 383 530 – Bench made to measure  
Diner 3S3 530 – Length 85/95/105/125



Diner 383 533 – Bench made to measure  
Diner 3S3 533 – Length 85/95/105/125

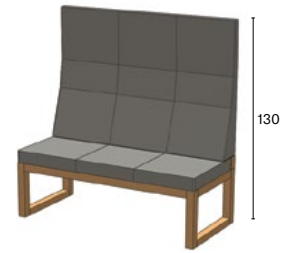

Diner 383 536 – Bench made to measure  
Diner 3S3 536 – Length 85/95/105/125

## ■ End-of-row module

The seat of the end-of-row module is 155 cm long. The backrest of this unit is always 30 cm shorter, which creates an exceptional ending of the row. The module can be placed both on the right and left end of the row or be used independently. In the price list, the price is given for the whole unit. In case of upholstery in natural leather, this module is provided with a seam on the seat part (due to the leather utilization and the length of the module).

## ■ End-of-row benches made to measure

The length of the seat of the end-of-row bench made to measure ranges between 85 and 155 cm. The length of the back is always 30 cm shorter (i.e. between 55 and 125 cm). In the price list, the price is given per 1 running meter and is calculated from the seat length of the end-of-row unit. In case of upholstery in pigmented leather, the end-of-row bench with seat length of more than 130 cm is provided with a seam on the seat part (due to the leather utilization and the length of the bench).

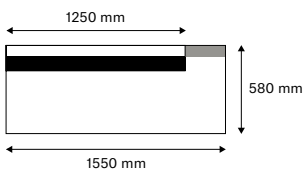

Diner 383 530 – End-of-row bench made to measure  
Diner 3S3 530 – Length 155/125

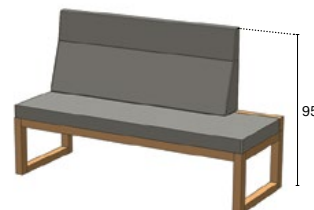

Diner 383 533 – End-of-row bench made to measure  
Diner 3S3 533 – Length 155/125

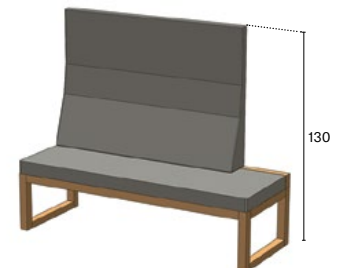

Diner 383 536 – End-of-row bench made to measure  
Diner 3S3 536 – Length 155/125

### ■ Corner benches

We offer corner benches in two versions – either under the angle of 90° or with a semi-circular backrest. Corner units can be used both to connect the individual units under the angle of 90° and to end the row of the benches. In the price list, the price is given for the whole unit.

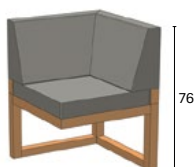

Diner 383 531

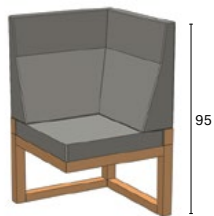

Diner 383 534

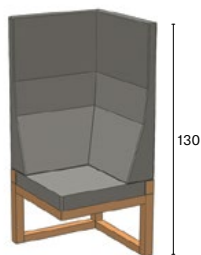

Diner 383 537

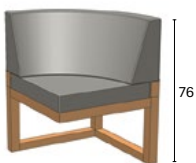
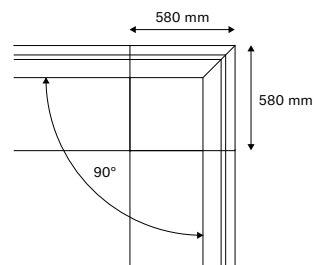

Diner 383 532

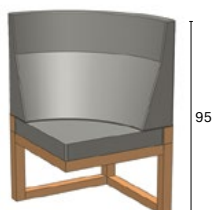

Diner 383 535

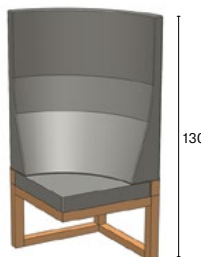

Diner 383 538

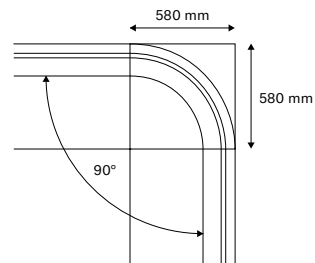

### ■ Side table

With a side table, you can create an original ending of the row of benches. You can place it both on the right and left side of the bench, but never as an independent unit. The table top is offered only in the length of 120 cm. The height of the side table is 37 cm. It is not designed to be sat on.



Diner 4UI 530

### ■ Cushion

This simple detail can be used not only as a practical armrest, but also as a comfortable accessory. It can also optically separate individual seat places. In the price list, you can find the Diner cushion under reference 309 253.



Diner 309 253

# diner – ground plan – example

Purchase orders for Diner benches are accepted only with an enclosed ground plan specifying place dimensions, dimensions of benches or supplementary components, and their arrangement in

space. Below, an example of feasible combinations of bench units is displayed, as well as the layout of possible dimensions of benches.

! The Seller reserves the right to deviation tolerance from the length of straight bench units up to -4 mm per 1 running meter (the deviation is given by construction reasons).

## Ground plan

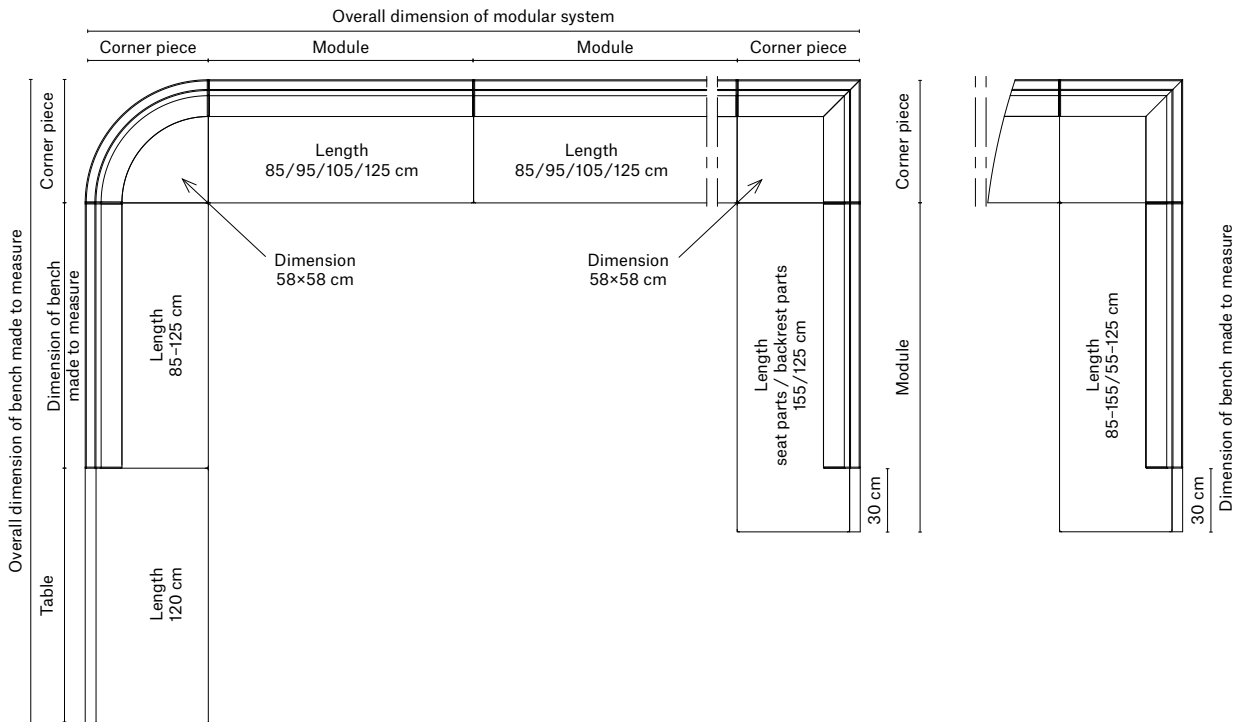

## Arrangement of bench units

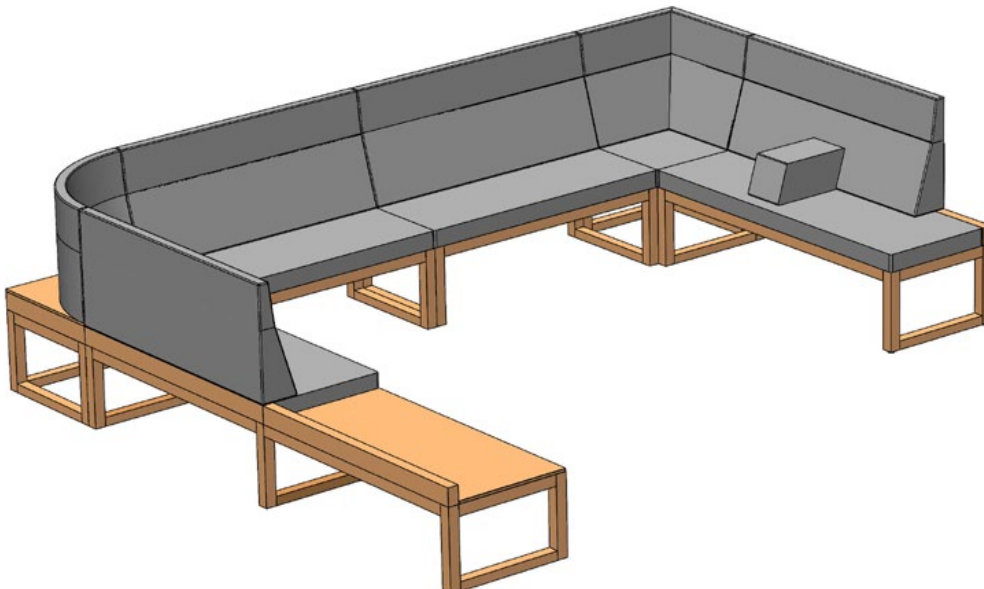

The Gufy benches collection was designed to meet the requirements of any space – both public and private. The seating part **A** with low backrest imitates modern sofas, adding domestic atmosphere even to public spaces. By backrest panels **B**, both the low and high versions, the space can be optically divided, creating thus a calm place for dining. While looking elegant, backrest panels also help to reduce the noise from open space.

The core of the collection are straight modules, end-of-row modules and a corner bench, along with an additional armrest and a cushion. Besides the cost effective modular system, the length of straight modules can be adjusted to your needs.

We offer all units in three backrest heights and either on legs or laminate base, which comes in black colour only. Benches on legs can be made also with a lower seat height of 38 cm. The sitting comfort is provided by the structure of foam layers.

Wooden parts in both beech and oak version can be finished in all colours from our collection. It is possible to use different upholstery materials for the seat and backrest part, and two types of decorative stitching for backrest panels. By default, all units have upholstered both front and back side of the backrest, so they can be placed anywhere in space.

! Please note that dimensions of the benches are given without levelling screws. The levelling screws can thus additionally increase the overall height and the seat height of the Gufy benches by up to 15 mm (depending on the floor unevenness).



## ■ Bench modular system

We offer the units of bench modular system both on legs and laminate base in pre-prepared lengths of 80, 90, 100 and 120 cm. Individual modules can be freely combined both in respect to their lengths and to their heights. In the price list, the price is given for the whole unit. The benches on bases to be placed at the end of the row are provided with the base 17 cm shorter than the seat part.

## ■ Benches made to measure

The dimensions of individual units of benches made to measure range between 80 and 120 cm. In the price list, the price is given per 1 running meter and is calculated from the seat length of the bench. The benches on laminate bases to be placed at the end of the row are provided with the base 17 cm shorter than the seat part (the price is calculated from the seat length of the bench).



Gufy 383 852 – Bench made to measure  
Gufy 3S3 852 – Length 80/90/100/120

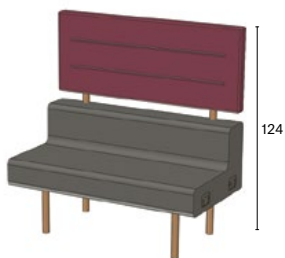

Gufy 383 852L – Bench made to measure  
Gufy 3S3 852L – Length 80/90/100/120



Gufy 383 852H – Bench made to measure  
Gufy 3S3 852H – Length 80/90/100/120



Gufy 383 855 – Bench made to measure  
Gufy 3S3 855 – Length 80/90/100/120

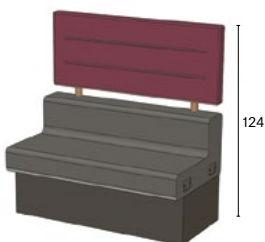

Gufy 383 855L – Bench made to measure  
Gufy 3S3 855L – Length 80/90/100/120

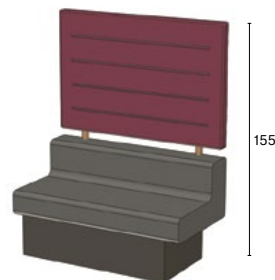

Gufy 383 855H – Bench made to measure  
Gufy 3S3 855H – Length 80/90/100/120



**Corner benches**

We offer corner benches in three backrest heights and either on legs or laminate base. Corner units can be used both to connect the individual units under the angle of 90° and to end the row of the benches. The seat of the corner unit is 5 cm longer than the straight units, which means it will overlap at the edges. In the price list, the price is given for the whole unit.

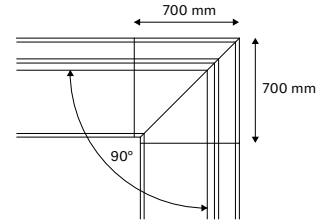

Gufy 383 853

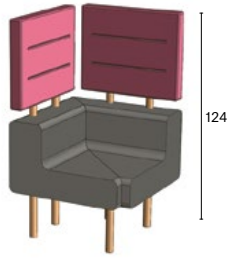

Gufy 383 853L

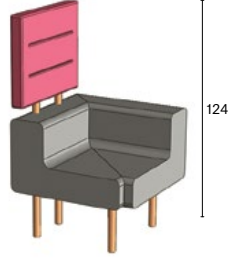

Gufy 383 853L1

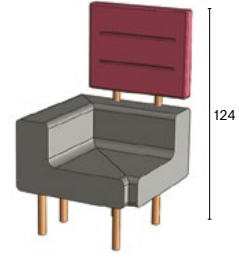

Gufy 383 853L2

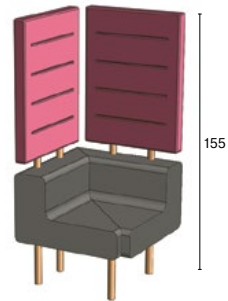

Gufy 383 853H

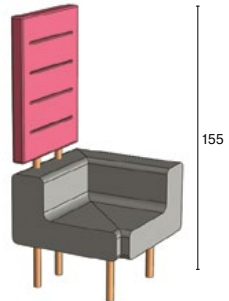

Gufy 383 853H1

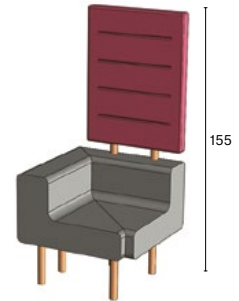

Gufy 383 853H2

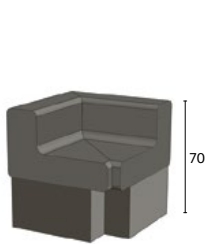

Gufy 383 856

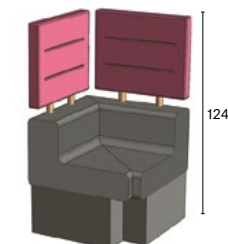

Gufy 383 856L

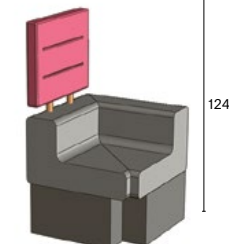

Gufy 383 856L1

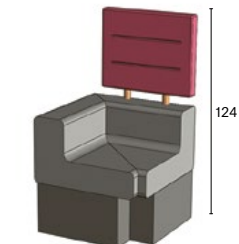

Gufy 383 856L2

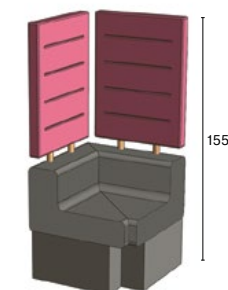

Gufy 383 856H

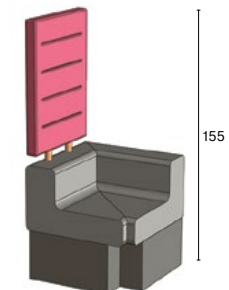

Gufy 383 856H1

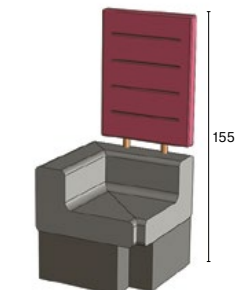

Gufy 383 856H2

### ■ End-of-row units

End-of-row units can be connected to straight modules as well as corner benches. We offer this unit only as a module with seat length of 60 cm, both on legs and laminate base. On corner units, the laminate base is shorter than the seat part by 17 cm. In the price list, the price is given for the whole unit.



Gufy 383 854



Gufy 383 857



Gufy 309 255

### ■ Additional armrest

The additional armrest can be added to any kind of straight bench unit. It follows the dimensions of the seat part of the bench and a backrest panel cannot be attached to it. You can use the additional armrest on both sides and make thus an armchair. Any kind of decorative stitching can be applied on the external part of the armrest. In the price list, you can find the armrest under reference 309 255.

### ■ Cushion

This simple detail can be used not only as a practical armrest, but also as a comfortable accessory. It can also optically separate individual seat places. In the price list, you can find the Gufy cushion under reference 309 254.



Gufy 309 254

### ■ Upholstery decoration

Backrest panels and additional armrests can be provided with upholstery decoration S004 with buttons or S008 with horizontal stitches. It is already included in the price, so when placing the order specify its reference number.

! Please note that the Gufy bench is not available in aniline or semi-aniline leather. Leather does not come in large enough lengths to cover the bench without visible seams, and seamless upholstery is important to the overall look of this product.

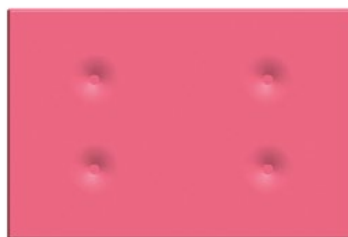

S004

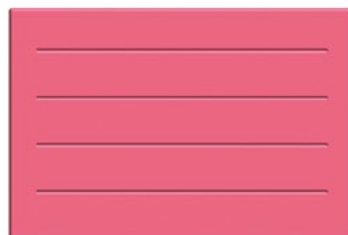
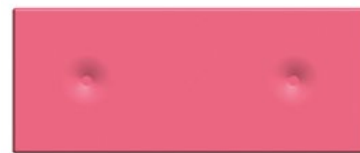

S008

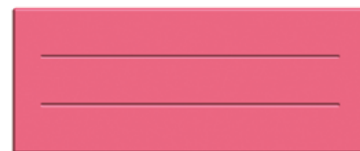

# gufy – ground plan – example

Purchase orders for Gufy benches are accepted only with an enclosed ground plan specifying place dimensions, dimensions of benches or supplementary components, and their arrangement in space. If you want to have a special combination

of upholstery materials and decorative stitching, specify it in your order. Below, an example of feasible combinations of bench units is displayed, as well as the layout of possible dimensions of benches.

! The Seller reserves the right to deviation tolerance from the length of straight bench units up to -4 mm per 1 running meter (the deviation is given by construction reasons). Due to safety reasons, we recommend benches with higher backrest to be placed against the wall or back to back.

## Ground plan

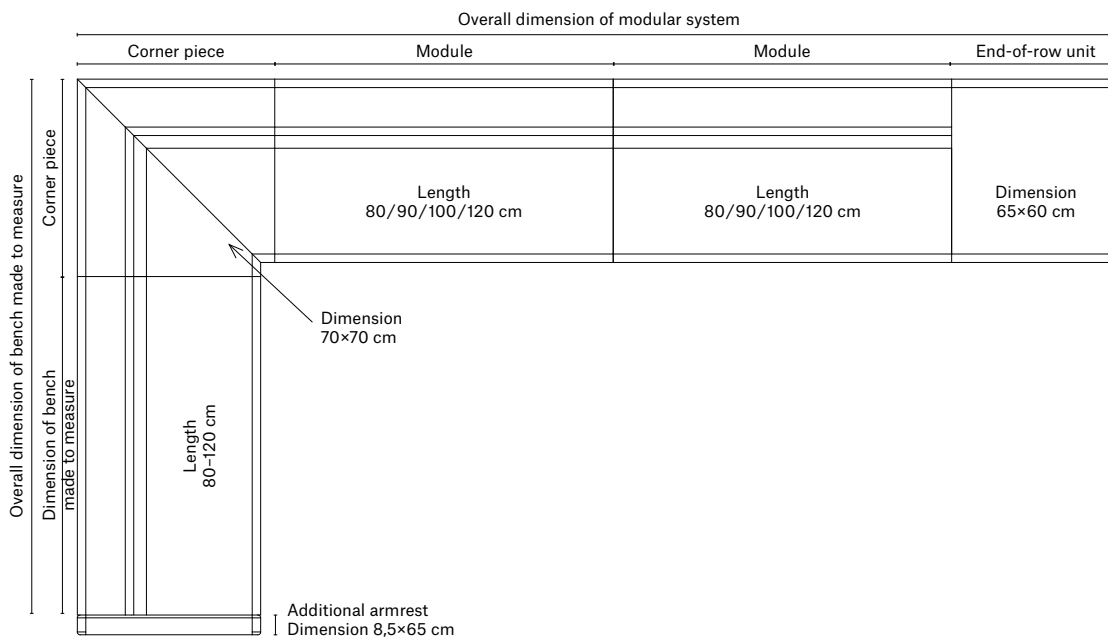

## Arrangement of bench units

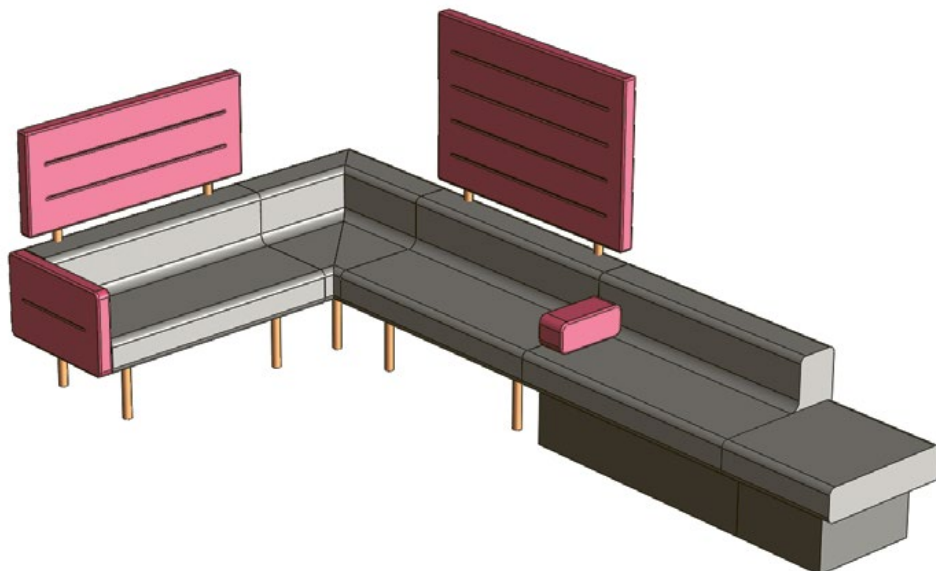

# assembly instructions

## ■ Diner

Benches are delivered in individual parts to be connected by screws in several points. Backrest parts are connected by a wooden dowel that prevents the individual parts from an uneven strain. Individual parts are numbered in respect to the assembly process. For assembly of the benches, you will need a handling area of at least 5 cm.

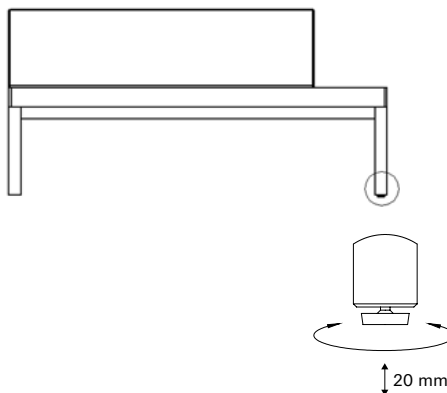
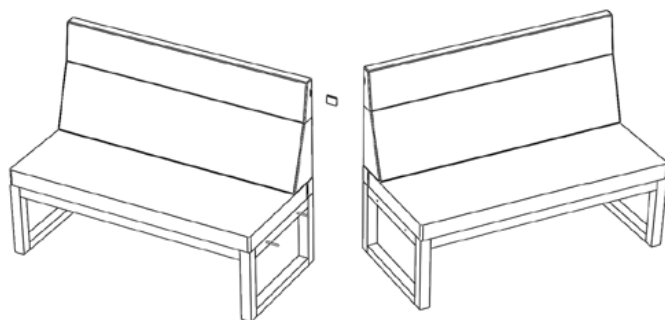

## ■ Gufy

Benches are delivered in individual parts to be connected by hardware. Individual parts are numbered in respect to the assembly process. For safety reasons, when delivered, benches don't have legs attached. To assemble the benches, you will need a handling area of at least 5 cm.

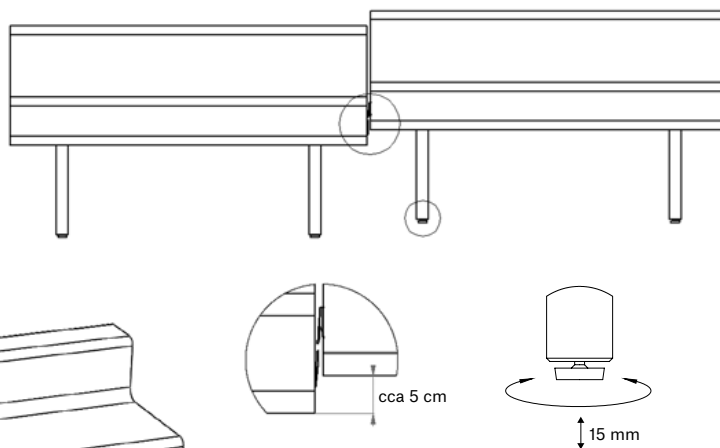
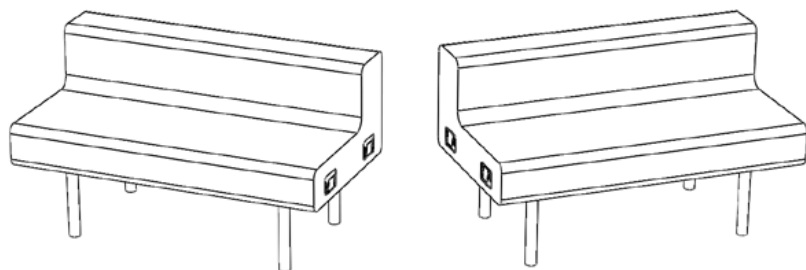

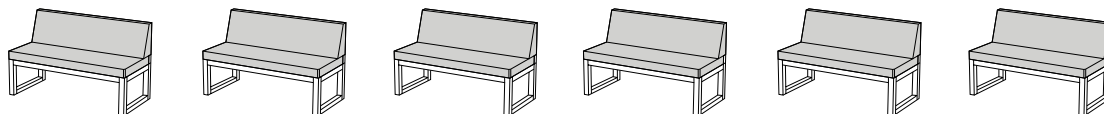

PRODUCT NUMBER	3S3 530	3S3 530	3S3 530	3S3 530	3S3 530	3S3 530
Type	module 85 cm	module 85 cm	module 95 cm	module 95 cm	module 105 cm	module 105 cm
Seat option	upholstery	upholstery	upholstery	upholstery	upholstery	upholstery
Back option	upholstery	upholstery	upholstery	upholstery	upholstery	upholstery
Type of wood	beech	oak	beech	oak	beech	oak
<b>PRICES IN € (VAT NOT INCLUDED)</b>						
Upholstery - category A	802,00	1 015,00	875,00	1 109,00	961,00	1 210,00
Upholstery - category B	857,00	1 070,00	937,00	1 171,00	1 029,00	1 278,00
Upholstery - category C	902,00	1 115,00	987,00	1 221,00	1 085,00	1 334,00
Upholstery - category D	1 002,00	1 215,00	1 100,00	1 334,00	1 208,00	1 457,00
Upholstery - category E	1 253,00	1 466,00	1 381,00	1 615,00	1 518,00	1 767,00
Upholstery - category 1	1 188,00	1 401,00	1 306,00	1 540,00	1 438,00	1 687,00
Upholstery - category 2						
Upholstery - COM	754,00	967,00	822,00	1 056,00	903,00	1 152,00
<b>SURCHARGES IN € (VAT NOT INCLUDED)</b>						
Antique colour	44,00		50,00		55,00	
Pigment colours	60,00	60,00	66,00	66,00	72,00	72,00
Foam BS 5852 Crib 5	47,00	47,00	53,00	53,00	57,00	57,00
<b>TECHNICAL INFORMATION</b>						
Total width (cm)	85	85	95	95	105	105
Total depth (cm)	58	58	58	58	58	58
Total height (cm)	76	76	76	76	76	76
Seat height (cm)	44	44	44	44	44	44
Width of seat (cm)	85	85	95	95	105	105
Depth of seat (cm)	40,5	40,5	40,5	40,5	40,5	40,5
Weight of product (kg)	29	29	31	31	33	33
Consumption of fabric (m)	2,500	2,500	2,808	2,808	3,088	3,088
Consumption of leather (m <sup>2</sup> )	6,247	6,247	6,983	6,983	7,718	7,718
Packing (pcs)	1	1	1	1	1	1
Volume (m <sup>3</sup> /pc)	1,103	1,103	1,225	1,225	1,348	1,348
Carton dimensions (cm)						

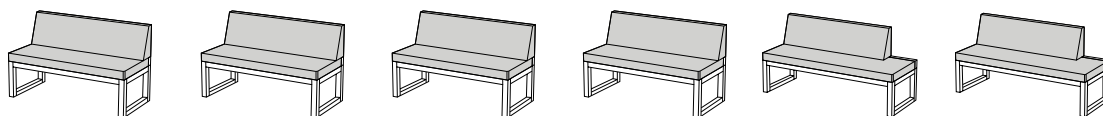

PRODUCT NUMBER	3S3 530	3S3 530	383 530	383 530	3S3 530	3S3 530
Type	module 125 cm	module 125 cm	bench made to measure	bench made to measure	end-of-row bench	end-of-row bench
			price per running metre	price per running metre	module 155/125 cm	module 155/125 cm
Seat option	upholstery	upholstery	upholstery	upholstery	upholstery	upholstery
Back option	upholstery	upholstery	upholstery	upholstery	upholstery	upholstery
Type of wood	beech	oak	beech	oak	beech	oak
<b>PRICES IN € (VAT NOT INCLUDED)</b>						
Upholstery - category A	1 149,00	1 437,00	1 029,00	1 300,00	1 331,00	1 680,00
Upholstery - category B	1 230,00	1 518,00	1 094,00	1 365,00	1 423,00	1 772,00
Upholstery - category C	1 296,00	1 584,00	1 147,00	1 418,00	1 499,00	1 848,00
Upholstery - category D	1 443,00	1 731,00	1 264,00	1 535,00	1 666,00	2 015,00
Upholstery - category E	1 811,00	2 099,00	1 559,00	1 830,00	2 086,00	2 435,00
Upholstery - category 1	1 716,00	2 004,00	1 483,00	1 754,00	1 977,00	2 326,00
Upholstery - category 2						
Upholstery - COM	1 079,00	1 367,00	973,00	1 244,00	1 252,00	1 601,00
<b>SURCHARGES IN € (VAT NOT INCLUDED)</b>						
Antique colour	66,00		52,00		81,00	
Pigment colours	86,00	86,00	69,00	69,00	106,00	106,00
Foam BS 5852 Crib 5	68,00	68,00	55,00	55,00	85,00	85,00
<b>TECHNICAL INFORMATION</b>						
Total width (cm)	125	125	85-125	85-125	155/125	155/125
Total depth (cm)	58	58	58	58	58	58
Total height (cm)	76	76	76	76	76	76
Seat height (cm)	44	44	44	44	44	44
Width of seat (cm)	125	125	85-125	85-125	155	155
Depth of seat (cm)	40,5	40,5	40,5	40,5	40,5	40,5
Weight of product (kg)	38	38	29-38	29-38	42,2	42,2
Consumption of fabric (m)	3,676	3,676	2,940	2,940	4,186	4,186
Consumption of leather (m <sup>2</sup> )	9,187	9,187	7,350	7,350	10,464	10,464
Packing (pcs)	1	1	1	1	1	1
Volume (m <sup>3</sup> /pc)	1,593	1,593	1,286	1,286	1,960	1,960
Carton dimensions (cm)						

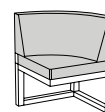
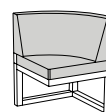
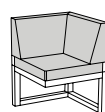
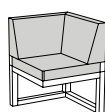
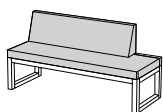
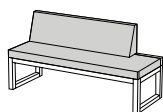

PRODUCT NUMBER	383 530	383 530	383 531	383 531	383 532	383 532
Type	end-of-row bench	end-of-row bench	corner bench	corner bench	corner bench	corner bench
	bench made to measure	bench made to measure				
Seat option	upholstery	upholstery	upholstery	upholstery	upholstery	upholstery
Back option	upholstery	upholstery	upholstery	upholstery	upholstery	upholstery
Type of wood	beech	oak	beech	oak	beech	oak
<b>PRICES IN € (VAT NOT INCLUDED)</b>						
Upholstery - category A	1 029,00	1 300,00	862,00	1 100,00	891,00	1 143,00
Upholstery - category B	1 094,00	1 365,00	905,00	1 143,00	935,00	1 187,00
Upholstery - category C	1 147,00	1 418,00	941,00	1 179,00	971,00	1 223,00
Upholstery - category D	1 264,00	1 535,00	1 020,00	1 258,00	1 050,00	1 302,00
Upholstery - category E	1 559,00	1 830,00	1 218,00	1 456,00	1 248,00	1 500,00
Upholstery - category 1	1 483,00	1 754,00	1 167,00	1 405,00	1 197,00	1 449,00
Upholstery - category 2						
Upholstery - COM	973,00	1 244,00	824,00	1 062,00	854,00	1 106,00
<b>SURCHARGES IN € (VAT NOT INCLUDED)</b>						
Antique colour	52,00		33,00		34,00	
Pigment colours	69,00	69,00	64,00	64,00	66,00	66,00
Foam BS 5852 Crib 5	55,00	55,00	37,00	37,00	36,00	36,00
<b>TECHNICAL INFORMATION</b>						
Total width (cm)	85-155/55-125	85-155/55-125	58	58	58	58
Total depth (cm)	58	58	58	58	58	58
Total height (cm)	76	76	76	76	76	76
Seat height (cm)	44	44	44	44	44	44
Width of seat (cm)	85-155	85-155				
Depth of seat (cm)	40,5	40,5	40,5	40,5	40,5	40,5
Weight of product (kg)	23,2-42,2	23,2-42,2	25,3	25,3	24	24
Consumption of fabric (m)	2,940	2,940	1,976	1,976	1,976	1,976
Consumption of leather (m <sup>2</sup> )	7,350	7,350	4,940	4,940	4,940	4,940
Packing (pcs)	1	1	1	1	1	1
Volume (m <sup>3</sup> /pc)	1,286	1,286	0,772	0,772	0,772	0,772
Carton dimensions (cm)						

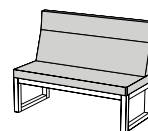
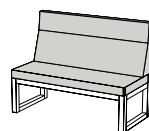
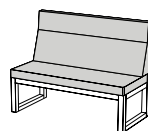
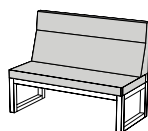
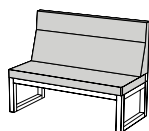
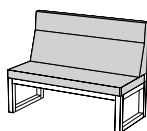

PRODUCT NUMBER	3S3 533	3S3 533	3S3 533	3S3 533	3S3 533	3S3 533
Type	module 85 cm	module 85 cm	module 95 cm	module 95 cm	module 105 cm	module 105 cm
Seat option	upholstery	upholstery	upholstery	upholstery	upholstery	upholstery
Back option	upholstery	upholstery	upholstery	upholstery	upholstery	upholstery
Type of wood	beech	oak	beech	oak	beech	oak
<b>PRICES IN € (VAT NOT INCLUDED)</b>						
Upholstery - category A	997,00	1 210,00	1 059,00	1 293,00	1 209,00	1 458,00
Upholstery - category B	1 059,00	1 272,00	1 128,00	1 362,00	1 286,00	1 535,00
Upholstery - category C	1 109,00	1 322,00	1 185,00	1 419,00	1 348,00	1 597,00
Upholstery - category D	1 222,00	1 435,00	1 310,00	1 544,00	1 487,00	1 736,00
Upholstery - category E	1 503,00	1 716,00	1 625,00	1 859,00	1 835,00	2 084,00
Upholstery - category 1	1 430,00	1 643,00	1 544,00	1 778,00	1 745,00	1 994,00
Upholstery - category 2						
Upholstery - COM	943,00	1 156,00	1 000,00	1 234,00	1 144,00	1 393,00
<b>SURCHARGES IN € (VAT NOT INCLUDED)</b>						
Antique colour	44,00		50,00		55,00	
Pigment colours	60,00	60,00	66,00	66,00	72,00	72,00
Foam BS 5852 Crib 5	53,00	53,00	59,00	59,00	65,00	65,00
<b>TECHNICAL INFORMATION</b>						
Total width (cm)	85	85	95	95	105	105
Total depth (cm)	58	58	58	58	58	58
Total height (cm)	95	95	95	95	95	95
Seat height (cm)	44	44	44	44	44	44
Width of seat (cm)	85	85	95	95	105	105
Depth of seat (cm)	40,5	40,5	40,5	40,5	40,5	40,5
Weight of product (kg)	31	31	33	33	35	35
Consumption of fabric (m)	2,808	2,808	3,138	3,138	3,469	3,469
Consumption of leather (m <sup>2</sup> )	7,020	7,020	7,846	7,846	8,671	8,671
Packing (pcs)	1	1	1	1	1	1
Volume (m <sup>3</sup> /pc)	1,361	1,361	1,512	1,512	1,664	1,664
Carton dimensions (cm)						



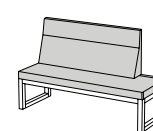
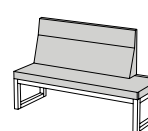
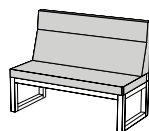
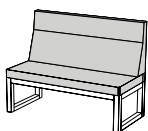
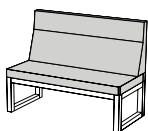
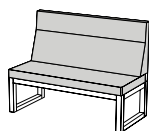

PRODUCT NUMBER	3S3 533	3S3 533	383 533	383 533	3S3 533	3S3 533
Type	module 125 cm	module 125 cm	bench made to measure	bench made to measure	end-of-row bench	end-of-row bench
			price per running metre	price per running metre	module 155/125 cm	module 155/125 cm
Seat option	upholstery	upholstery	upholstery	upholstery	upholstery	upholstery
Back option	upholstery	upholstery	upholstery	upholstery	upholstery	upholstery
Type of wood	beech	oak	beech	oak	beech	oak
<b>PRICES IN € (VAT NOT INCLUDED)</b>						
Upholstery - category A	1 393,00	1 681,00	1 169,00	1 440,00	1 603,00	1 952,00
Upholstery - category B	1 484,00	1 772,00	1 242,00	1 513,00	1 705,00	2 054,00
Upholstery - category C	1 558,00	1 846,00	1 302,00	1 573,00	1 789,00	2 138,00
Upholstery - category D	1 723,00	2 011,00	1 434,00	1 705,00	1 975,00	2 324,00
Upholstery - category E	2 137,00	2 425,00	1 765,00	2 036,00	2 440,00	2 789,00
Upholstery - category 1	2 031,00	2 319,00	1 680,00	1 951,00	2 320,00	2 669,00
Upholstery - category 2						
Upholstery - COM	1 314,00	1 602,00	1 107,00	1 378,00	1 515,00	1 864,00
<b>SURCHARGES IN € (VAT NOT INCLUDED)</b>						
Antique colour	66,00		52,00		81,00	
Pigment colours	86,00	86,00	69,00	69,00	106,00	106,00
Foam BS 5852 Crib 5	77,00	77,00	62,00	62,00	95,00	95,00
<b>TECHNICAL INFORMATION</b>						
Total width (cm)	125	125	85-125	85-125	155/125	155/125
Total depth (cm)	58	58	58	58	58	58
Total height (cm)	95	95	95	95	95	95
Seat height (cm)	44	44	44	44	44	44
Width of seat (cm)	125	125	85-125	85-125	155	155
Depth of seat (cm)	40,5	40,5	40,5	40,5	40,5	40,5
Weight of product (kg)	40	40	31-40	31-40	44,5	44,5
Consumption of fabric (m)	4,129	4,129	3,303	3,303	4,640	4,640
Consumption of leather (m <sup>2</sup> )	10,324	10,324	8,259	8,259	11,598	11,598
Packing (pcs)	1	1	1	1	1	1
Volume (m <sup>3</sup> /pc)	1,966	1,966	1,588	1,588	2,420	2,420
Carton dimensions (cm)						

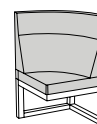
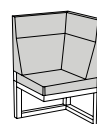
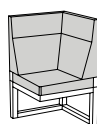
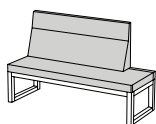
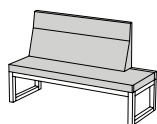

PRODUCT NUMBER	383 533	383 533	383 534	383 534	383 535	383 535
Type	end-of-row bench	end-of-row bench	corner bench	corner bench	corner bench	corner bench
	bench made to measure					
Seat option	upholstery	upholstery	upholstery	upholstery	upholstery	upholstery
Back option	upholstery	upholstery	upholstery	upholstery	upholstery	upholstery
Type of wood	beech	oak	beech	oak	beech	oak
<b>PRICES IN € (VAT NOT INCLUDED)</b>						
Upholstery - category A	1 169,00	1 440,00	979,00	1 217,00	998,00	1 250,00
Upholstery - category B	1 242,00	1 513,00	1 036,00	1 274,00	1 055,00	1 307,00
Upholstery - category C	1 302,00	1 573,00	1 082,00	1 320,00	1 101,00	1 353,00
Upholstery - category D	1 434,00	1 705,00	1 185,00	1 423,00	1 204,00	1 456,00
Upholstery - category E	1 765,00	2 036,00	1 444,00	1 682,00	1 462,00	1 714,00
Upholstery - category 1	1 680,00	1 951,00	1 377,00	1 615,00	1 396,00	1 648,00
Upholstery - category 2						
Upholstery - COM	1 107,00	1 378,00	931,00	1 169,00	949,00	1 201,00
<b>SURCHARGES IN € (VAT NOT INCLUDED)</b>						
Antique colour	52,00		33,00		34,00	
Pigment colours	69,00	69,00	64,00	64,00	66,00	66,00
Foam BS 5852 Crib 5	62,00	62,00	48,00	48,00	47,00	47,00
<b>TECHNICAL INFORMATION</b>						
Total width (cm)	85-155/55-125	85-155/55-125	58	58	58	58
Total depth (cm)	58	58	58	58	58	58
Total height (cm)	95	95	95	95	95	95
Seat height (cm)	44	44	44	44	44	44
Width of seat (cm)	85-155	85-155				
Depth of seat (cm)	40,5	40,5	40,5	40,5	40,5	40,5
Weight of product (kg)	24,4-44,5	24,4-44,5	27,5	27,5	26	26
Consumption of fabric (m)	3,303	3,303	2,574	2,574	2,574	2,574
Consumption of leather (m <sup>2</sup> )	8,259	8,259	6,435	6,435	6,435	6,435
Packing (pcs)	1	1	1	1	1	1
Volume (m <sup>3</sup> /pc)	1,588	1,588	0,953	0,953	0,953	0,953
Carton dimensions (cm)						

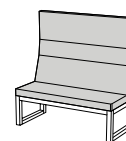
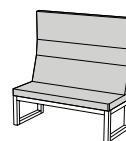
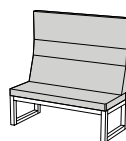
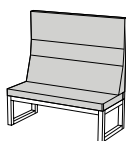
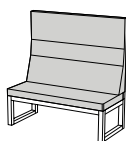
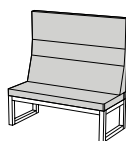

PRODUCT NUMBER	3S3 536	3S3 536	3S3 536	3S3 536	3S3 536	3S3 536
Type	module 85 cm	module 85 cm	module 95 cm	module 95 cm	module 105 cm	module 105 cm

Seat option	upholstery	upholstery	upholstery	upholstery	upholstery	upholstery
Back option	upholstery	upholstery	upholstery	upholstery	upholstery	upholstery
Type of wood	beech	oak	beech	oak	beech	oak

**PRICES IN €  
(VAT NOT INCLUDED)**

Upholstery - category A	1 094,00	1 307,00	1 196,00	1 430,00	1 450,00	1 699,00
Upholstery - category B	1 166,00	1 379,00	1 276,00	1 510,00	1 538,00	1 787,00
Upholstery - category C	1 224,00	1 437,00	1 341,00	1 575,00	1 610,00	1 859,00
Upholstery - category D	1 354,00	1 567,00	1 486,00	1 720,00	1 771,00	2 020,00
Upholstery - category E	1 680,00	1 893,00	1 851,00	2 085,00	2 174,00	2 423,00
Upholstery - category 1	1 596,00	1 809,00	1 757,00	1 991,00	2 070,00	2 319,00
Upholstery - category 2						
Upholstery - COM	1 032,00	1 245,00	1 127,00	1 361,00	1 374,00	1 623,00

**SURCHARGES IN €  
(VAT NOT INCLUDED)**

Antique colour	44,00		50,00		55,00	
Pigment colours	60,00	60,00	66,00	66,00	72,00	72,00
Foam BS 5852 Crib 5	62,00	62,00	69,00	69,00	77,00	77,00

**TECHNICAL INFORMATION**

Total width (cm)	85	85	95	95	105	105
Total depth (cm)	58	58	58	58	58	58
Total height (cm)	130	130	130	130	130	130
Seat height (cm)	44	44	44	44	44	44
Width of seat (cm)	85	85	95	95	105	105
Depth of seat (cm)	40,5	40,5	40,5	40,5	40,5	40,5
Weight of product (kg)	35	35	37	37	40	40
Consumption of fabric (m)	3,251	3,251	3,632	3,632	4,015	4,015
Consumption of leather (m <sup>2</sup> )	8,124	8,124	9,079	9,079	10,035	10,035
Packing (pcs)	1	1	1	1	1	1
Volume (m <sup>3</sup> /pc)	1,838	1,838	2,042	2,042	2,246	2,246
Carton dimensions (cm)						

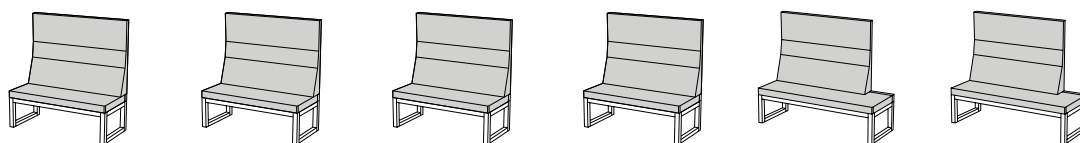

PRODUCT NUMBER	3S3 536	3S3 536	383 536	383 536	3S3 536	3S3 536
Type	module 125 cm	module 125 cm	bench made to measure	bench made to measure	end-of-row bench	end-of-row bench
			price per running metre	price per running metre	module 155/125 cm	module 155/125 cm
Seat option	upholstery	upholstery	upholstery	upholstery	upholstery	upholstery
Back option	upholstery	upholstery	upholstery	upholstery	upholstery	upholstery
Type of wood	beech	oak	beech	oak	beech	oak
<b>PRICES IN € (VAT NOT INCLUDED)</b>						
Upholstery - category A	1 672,00	1 960,00	1 316,00	1 587,00	1 921,00	2 270,00
Upholstery - category B	1 778,00	2 066,00	1 400,00	1 671,00	2 037,00	2 386,00
Upholstery - category C	1 864,00	2 152,00	1 469,00	1 740,00	2 133,00	2 482,00
Upholstery - category D	2 055,00	2 343,00	1 622,00	1 893,00	2 344,00	2 693,00
Upholstery - category E	2 534,00	2 822,00	2 005,00	2 276,00	2 875,00	3 224,00
Upholstery - category 1	2 410,00	2 698,00	1 906,00	2 177,00	2 737,00	3 086,00
Upholstery - category 2						
Upholstery - COM	1 582,00	1 870,00	1 243,00	1 514,00	1 820,00	2 169,00
<b>SURCHARGES IN € (VAT NOT INCLUDED)</b>						
Antique colour	66,00		52,00		81,00	
Pigment colours	86,00	86,00	69,00	69,00	106,00	106,00
Foam BS 5852 Crib 5	91,00	91,00	73,00	73,00	112,00	112,00
<b>TECHNICAL INFORMATION</b>						
Total width (cm)	125	125	85-125	85-125	155/125	155/125
Total depth (cm)	58	58	58	58	58	58
Total height (cm)	130	130	130	130	130	130
Seat height (cm)	44	44	44	44	44	44
Width of seat (cm)	125	125	85-125	85-125	155	155
Depth of seat (cm)	40,5	40,5	40,5	40,5	40,5	40,5
Weight of product (kg)	46	46	35-46	35-46	50,5	50,5
Consumption of fabric (m)	4,780	4,780	3,824	3,824	5,291	5,291
Consumption of leather (m <sup>2</sup> )	11,947	11,947	9,558	9,558	13,222	13,222
Packing (pcs)	1	1	1	1	1	1
Volume (m <sup>3</sup> /pc)	2,654	2,654	2,144	2,144	3,266	3,266
Carton dimensions (cm)						

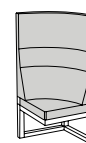
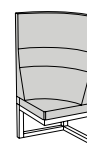
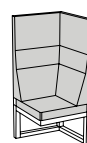
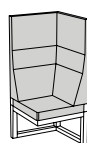
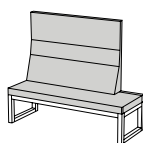
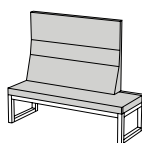

PRODUCT NUMBER	383 536	383 536	383 537	383 537	383 538	383 538
Type	end-of-row bench	end-of-row bench	corner bench	corner bench	corner bench	corner bench
	bench made to measure	bench made to measure				
Seat option	upholstery	upholstery	upholstery	upholstery	upholstery	upholstery
Back option	upholstery	upholstery	upholstery	upholstery	upholstery	upholstery
Type of wood	beech	oak	beech	oak	beech	oak
<b>PRICES IN € (VAT NOT INCLUDED)</b>						
Upholstery - category A	1 316,00	1 587,00	1 114,00	1 352,00	1 122,00	1 374,00
Upholstery - category B	1 400,00	1 671,00	1 179,00	1 417,00	1 188,00	1 440,00
Upholstery - category C	1 469,00	1 740,00	1 232,00	1 470,00	1 241,00	1 493,00
Upholstery - category D	1 622,00	1 893,00	1 350,00	1 588,00	1 359,00	1 611,00
Upholstery - category E	2 005,00	2 276,00	1 647,00	1 885,00	1 655,00	1 907,00
Upholstery - category 1	1 906,00	2 177,00	1 570,00	1 808,00	1 579,00	1 831,00
Upholstery - category 2						
Upholstery - COM	1 243,00	1 514,00	1 058,00	1 296,00	1 066,00	1 318,00
<b>SURCHARGES IN € (VAT NOT INCLUDED)</b>						
Antique colour	52,00		33,00		34,00	
Pigment colours	69,00	69,00	64,00	64,00	66,00	66,00
Foam BS 5852 Crib 5	73,00	73,00	65,00	65,00	63,00	63,00
<b>TECHNICAL INFORMATION</b>						
Total width (cm)	85-155/55-125	85-155/55-125	58	58	58	58
Total depth (cm)	58	58	58	58	58	58
Total height (cm)	130	130	130	130	130	130
Seat height (cm)	44	44	44	44	44	44
Width of seat (cm)	85-155	85-155				
Depth of seat (cm)	40,5	40,5	40,5	40,5	40,5	40,5
Weight of product (kg)	27,7-50,5	27,7-50,5	32	32	30	30
Consumption of fabric (m)	3,824	3,824	2,956	2,956	2,956	2,956
Consumption of leather (m <sup>2</sup> )	9,558	9,558	7,388	7,388	7,388	7,388
Packing (pcs)	1	1	1	1	1	1
Volume (m <sup>3</sup> /pc)	2,144	2,144	1,286	1,286	1,286	1,286
Carton dimensions (cm)						

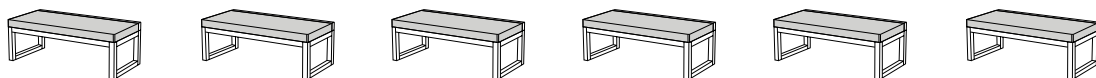

PRODUCT NUMBER	3S3 539	3S3 539	3S3 539	3S3 539	3S3 539	3S3 539
Type	module 85 cm	module 85 cm	module 95 cm	module 95 cm	module 105 cm	module 105 cm
Seat option	upholstery	upholstery	upholstery	upholstery	upholstery	upholstery
Back option						
Type of wood	beech	oak	beech	oak	beech	oak
<b>PRICES IN € (VAT NOT INCLUDED)</b>						
Upholstery - category A	640,00	853,00	699,00	933,00	755,00	1 004,00
Upholstery - category B	671,00	884,00	735,00	969,00	794,00	1 043,00
Upholstery - category C	697,00	910,00	764,00	998,00	827,00	1 076,00
Upholstery - category D	755,00	968,00	828,00	1 062,00	898,00	1 147,00
Upholstery - category E	900,00	1 113,00	990,00	1 224,00	1 077,00	1 326,00
Upholstery - category 1	863,00	1 076,00	948,00	1 182,00	1 031,00	1 280,00
Upholstery - category 2						
Upholstery - COM	612,00	825,00	668,00	902,00	721,00	970,00
<b>SURCHARGES IN € (VAT NOT INCLUDED)</b>						
Antique colour	44,00		50,00		55,00	
Pigment colours	60,00	60,00	66,00	66,00	72,00	72,00
Foam BS 5852 Crib 5	28,00	28,00	32,00	32,00	35,00	35,00
<b>TECHNICAL INFORMATION</b>						
Total width (cm)	85	85	95	95	105	105
Total depth (cm)	58	58	58	58	58	58
Total height (cm)	44	44	44	44	44	44
Seat height (cm)	44	44	44	44	44	44
Width of seat (cm)	85	85	95	95	105	105
Depth of seat (cm)	53	53	53	53	53	53
Weight of product (kg)	18	18	19,5	19,5	21	21
Consumption of fabric (m)	1,445	1,445	1,616	1,616	1,785	1,785
Consumption of leather (m <sup>2</sup> )	3,612	3,612	4,037	4,037	4,462	4,462
Packing (pcs)	1	1	1	1	1	1
Volume (m <sup>3</sup> /pc)	0,667	0,667	0,741	0,741	0,815	0,815
Carton dimensions (cm)						

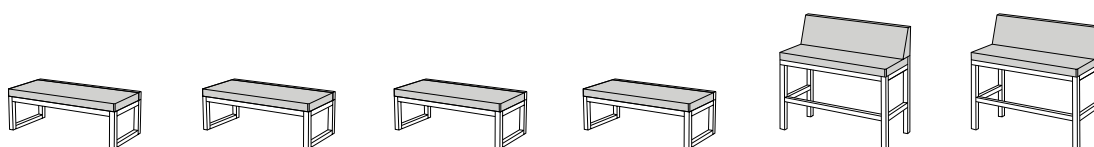

PRODUCT NUMBER	3S3 539	3S3 539	383 539	383 539	3S3 540	3S3 540
Type	module 125 cm	module 125 cm	bench made to measure	bench made to measure	bar bench	bar bench
			price per running metre	price per running metre	module 85 cm	module 85 cm
Seat option	upholstery	upholstery	upholstery	upholstery	upholstery	upholstery
Back option					upholstery	upholstery
Type of wood	beech	oak	beech	oak	beech	oak
<b>PRICES IN € (VAT NOT INCLUDED)</b>						
Upholstery - category A	874,00	1 162,00	822,00	1 093,00	949,00	1 204,00
Upholstery - category B	921,00	1 209,00	860,00	1 131,00	1 004,00	1 259,00
Upholstery - category C	959,00	1 247,00	890,00	1 161,00	1 049,00	1 304,00
Upholstery - category D	1 044,00	1 332,00	958,00	1 229,00	1 149,00	1 404,00
Upholstery - category E	1 257,00	1 545,00	1 129,00	1 400,00	1 400,00	1 655,00
Upholstery - category 1	1 202,00	1 490,00	1 085,00	1 356,00	1 335,00	1 590,00
Upholstery - category 2						
Upholstery - COM	834,00	1 122,00	790,00	1 061,00	901,00	1 156,00
<b>SURCHARGES IN € (VAT NOT INCLUDED)</b>						
Antique colour	66,00		52,00		66,00	
Pigment colours	86,00	86,00	69,00	69,00	90,00	90,00
Foam BS 5852 Crib 5	41,00	41,00	32,00	32,00	47,00	47,00
<b>TECHNICAL INFORMATION</b>						
Total width (cm)	125	125	85-125	85-125	85	85
Total depth (cm)	58	58	58	58	58	58
Total height (cm)	44	44	44	44	112	112
Seat height (cm)	44	44	44	44	80	80
Width of seat (cm)	125	125	85-125	85-125	85	85
Depth of seat (cm)	53	53	53	53	40,5	40,5
Weight of product (kg)	24	24	18-24	18-24	32	32
Consumption of fabric (m)	2,125	2,125	1,700	1,700	2,500	2,500
Consumption of leather (m <sup>2</sup> )	5,312	5,312	4,249	4,249	6,247	6,247
Packing (pcs)	1	1	1	1	1	1
Volume (m <sup>3</sup> /pc)	0,964	0,964	0,778	0,778	1,593	1,593
Carton dimensions (cm)						

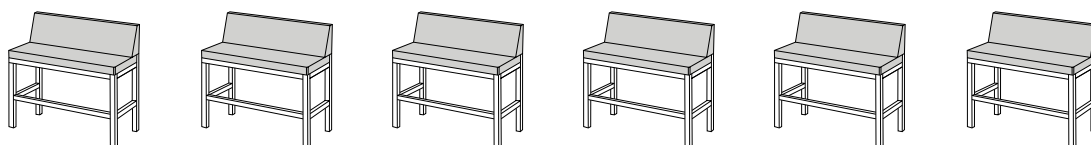

PRODUCT NUMBER	3S3 540	3S3 540	3S3 540	3S3 540	3S3 540	3S3 540
Type	bar bench	bar bench	bar bench	bar bench	bar bench	bar bench
	module 95 cm	module 95 cm	module 105 cm	module 105 cm	module 125 cm	module 125 cm
Seat option	upholstery	upholstery	upholstery	upholstery	upholstery	upholstery
Back option	upholstery	upholstery	upholstery	upholstery	upholstery	upholstery
Type of wood	beech	oak	beech	oak	beech	oak
<b>PRICES IN € (VAT NOT INCLUDED)</b>						
Upholstery - category A	1 041,00	1 320,00	1 137,00	1 440,00	1 333,00	1 682,00
Upholstery - category B	1 103,00	1 382,00	1 205,00	1 508,00	1 414,00	1 763,00
Upholstery - category C	1 153,00	1 432,00	1 261,00	1 564,00	1 480,00	1 829,00
Upholstery - category D	1 266,00	1 545,00	1 384,00	1 687,00	1 627,00	1 976,00
Upholstery - category E	1 547,00	1 826,00	1 694,00	1 997,00	1 995,00	2 344,00
Upholstery - category 1	1 472,00	1 751,00	1 614,00	1 917,00	1 900,00	2 249,00
Upholstery - category 2						
Upholstery - COM	988,00	1 267,00	1 079,00	1 382,00	1 263,00	1 612,00
<b>SURCHARGES IN € (VAT NOT INCLUDED)</b>						
Antique colour	75,00		83,00		99,00	
Pigment colours	99,00	99,00	108,00	108,00	129,00	129,00
Foam BS 5852 Crib 5	53,00	53,00	57,00	57,00	68,00	68,00
<b>TECHNICAL INFORMATION</b>						
Total width (cm)	95	95	105	105	125	125
Total depth (cm)	58	58	58	58	58	58
Total height (cm)	112	112	112	112	112	112
Seat height (cm)	80	80	80	80	80	80
Width of seat (cm)	95	95	105	105	125	125
Depth of seat (cm)	40,5	40,5	40,5	40,5	40,5	40,5
Weight of product (kg)	34	34	36	36	41	41
Consumption of fabric (m)	2,808	2,808	3,088	3,088	3,676	3,676
Consumption of leather (m <sup>2</sup> )	6,983	6,983	7,718	7,718	9,187	9,187
Packing (pcs)	1	1	1	1	1	1
Volume (m <sup>3</sup> /pc)	1,770	1,770	1,946	1,946	2,300	2,300
Carton dimensions (cm)						



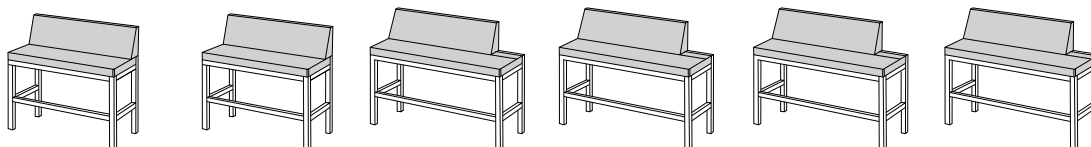

PRODUCT NUMBER	383 540	383 540	3S3 540	3S3 540	383 540	383 540
Type	bar bench	bar bench	end-of-row bench	end-of-row bench	end-of-row bench	end-of-row bench
	bench made to measure	bench made to measure	module 155/125 cm	module 155/125 cm	bench made to measure	bench made to measure
Seat option	upholstery	upholstery	upholstery	upholstery	upholstery	upholstery
Back option	upholstery	upholstery	upholstery	upholstery	upholstery	upholstery
Type of wood	beech	oak	beech	oak	beech	oak
<b>PRICES IN € (VAT NOT INCLUDED)</b>						
Upholstery - category A	1 205,00	1 527,00	1 595,00	2 023,00	1 205,00	1 527,00
Upholstery - category B	1 270,00	1 592,00	1 687,00	2 115,00	1 270,00	1 592,00
Upholstery - category C	1 323,00	1 645,00	1 763,00	2 191,00	1 323,00	1 645,00
Upholstery - category D	1 440,00	1 762,00	1 930,00	2 358,00	1 440,00	1 762,00
Upholstery - category E	1 735,00	2 057,00	2 350,00	2 778,00	1 735,00	2 057,00
Upholstery - category 1	1 659,00	1 981,00	2 241,00	2 669,00	1 659,00	1 981,00
Upholstery - category 2						
Upholstery - COM	1 149,00	1 471,00	1 516,00	1 944,00	1 149,00	1 471,00
<b>SURCHARGES IN € (VAT NOT INCLUDED)</b>						
Antique colour	78,00		122,00		78,00	
Pigment colours	104,00	104,00	159,00	159,00	104,00	104,00
Foam BS 5852 Crib 5	55,00	55,00	85,00	85,00	55,00	55,00
<b>TECHNICAL INFORMATION</b>						
Total width (cm)	85-125	85-125	155/125	155/125	85-155/55-125	85-155/55-125
Total depth (cm)	58	58	58	58	58	58
Total height (cm)	112	112	112	112	112	112
Seat height (cm)	80	80	80	80	80	80
Width of seat (cm)	85-125	85-125	155	155	85-155	85-155
Depth of seat (cm)	40,5	40,5	40,5	40,5	40,5	40,5
Weight of product (kg)	32-41	32-41	45,2	45,2	27,2-45,2	27,2-45,2
Consumption of fabric (m)	2,940	2,940	4,186	4,186	2,940	2,940
Consumption of leather (m <sup>2</sup> )	7,350	7,350	10,464	10,464	7,350	7,350
Packing (pcs)	1	1	1	1	1	1
Volume (m <sup>3</sup> /pc)	1,858	1,858	2,831	2,831	1,858	1,858
Carton dimensions (cm)						

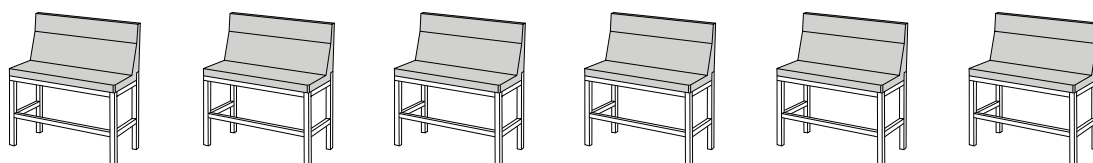

PRODUCT NUMBER	3S3 541	3S3 541	3S3 541	3S3 541	3S3 541	3S3 541
Type	bar bench	bar bench	bar bench	bar bench	bar bench	bar bench
	module 85 cm	module 85 cm	module 95 cm	module 95 cm	module 105 cm	module 105 cm
Seat option	upholstery	upholstery	upholstery	upholstery	upholstery	upholstery
Back option	upholstery	upholstery	upholstery	upholstery	upholstery	upholstery
Type of wood	beech	oak	beech	oak	beech	oak
<b>PRICES IN € (VAT NOT INCLUDED)</b>						
Upholstery - category A	1 144,00	1 399,00	1 225,00	1 504,00	1 385,00	1 688,00
Upholstery - category B	1 206,00	1 461,00	1 294,00	1 573,00	1 462,00	1 765,00
Upholstery - category C	1 256,00	1 511,00	1 351,00	1 630,00	1 524,00	1 827,00
Upholstery - category D	1 369,00	1 624,00	1 476,00	1 755,00	1 663,00	1 966,00
Upholstery - category E	1 650,00	1 905,00	1 791,00	2 070,00	2 011,00	2 314,00
Upholstery - category 1	1 577,00	1 832,00	1 710,00	1 989,00	1 921,00	2 224,00
Upholstery - category 2						
Upholstery - COM	1 090,00	1 345,00	1 166,00	1 445,00	1 320,00	1 623,00
<b>SURCHARGES IN € (VAT NOT INCLUDED)</b>						
Antique colour	66,00		75,00		83,00	
Pigment colours	90,00	90,00	99,00	99,00	108,00	108,00
Foam BS 5852 Crib 5	53,00	53,00	59,00	59,00	65,00	65,00
<b>TECHNICAL INFORMATION</b>						
Total width (cm)	85	85	95	95	105	105
Total depth (cm)	58	58	58	58	58	58
Total height (cm)	131	131	131	131	131	131
Seat height (cm)	80	80	80	80	80	80
Width of seat (cm)	85	85	95	95	105	105
Depth of seat (cm)	40,5	40,5	40,5	40,5	40,5	40,5
Weight of product (kg)	34	34	36	36	38	38
Consumption of fabric (m)	2,808	2,808	3,138	3,138	3,469	3,469
Consumption of leather (m <sup>2</sup> )	7,020	7,020	7,846	7,846	8,671	8,671
Packing (pcs)	1	1	1	1	1	1
Volume (m <sup>3</sup> /pc)	1,851	1,851	2,057	2,057	2,262	2,262
Carton dimensions (cm)						

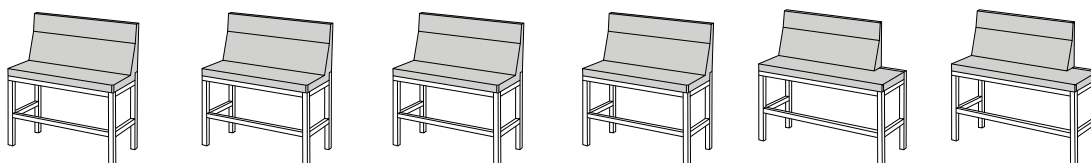

PRODUCT NUMBER	3S3 541	3S3 541	383 541	383 541	3S3 541	3S3 541
Type	bar bench	bar bench	bar bench	bar bench	end-of-row bench	end-of-row bench
	module 125 cm	module 125 cm	bench made to measure	bench made to measure	module 155/125 cm	module 155/125 cm
Seat option	upholstery	upholstery	upholstery	upholstery	upholstery	upholstery
Back option	upholstery	upholstery	upholstery	upholstery	upholstery	upholstery
Type of wood	beech	oak	beech	oak	beech	oak
<b>PRICES IN € (VAT NOT INCLUDED)</b>						
Upholstery - category A	1 577,00	1 926,00	1 345,00	1 667,00	1 867,00	2 295,00
Upholstery - category B	1 668,00	2 017,00	1 418,00	1 740,00	1 969,00	2 397,00
Upholstery - category C	1 742,00	2 091,00	1 478,00	1 800,00	2 053,00	2 481,00
Upholstery - category D	1 907,00	2 256,00	1 610,00	1 932,00	2 239,00	2 667,00
Upholstery - category E	2 321,00	2 670,00	1 941,00	2 263,00	2 704,00	3 132,00
Upholstery - category 1	2 215,00	2 564,00	1 856,00	2 178,00	2 584,00	3 012,00
Upholstery - category 2						
Upholstery - COM	1 498,00	1 847,00	1 283,00	1 605,00	1 779,00	2 207,00
<b>SURCHARGES IN € (VAT NOT INCLUDED)</b>						
Antique colour	99,00		78,00		122,00	
Pigment colours	129,00	129,00	104,00	104,00	159,00	159,00
Foam BS 5852 Crib 5	77,00	77,00	62,00	62,00	95,00	95,00
<b>TECHNICAL INFORMATION</b>						
Total width (cm)	125	125	85-125	85-125	155/125	155/125
Total depth (cm)	58	58	58	58	58	58
Total height (cm)	131	131	131	131	131	131
Seat height (cm)	80	80	80	80	80	80
Width of seat (cm)	125	125	85-125	85-125	155	155
Depth of seat (cm)	40,5	40,5	40,5	40,5	40,5	40,5
Weight of product (kg)	43	43	34-43	34-43	47,5	47,5
Consumption of fabric (m)	4,129	4,129	3,303	3,303	4,640	4,640
Consumption of leather (m <sup>2</sup> )	10,324	10,324	8,259	8,259	11,598	11,598
Packing (pcs)	1	1	1	1	1	1
Volume (m <sup>3</sup> /pc)	2,674	2,674	2,160	2,160	3,291	3,291
Carton dimensions (cm)						

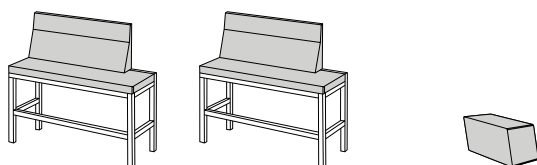

PRODUCT NUMBER	383 541	383 541	309 253
Type	end-of-row bench	end-of-row bench	cushion
	bench made to measure		bench made to measure
Seat option	upholstery	upholstery	
Back option	upholstery	upholstery	
Type of wood	beech	oak	
<b>PRICES IN € (VAT NOT INCLUDED)</b>			
Upholstery - category A	1 345,00	1 667,00	73,00
Upholstery - category B	1 418,00	1 740,00	86,00
Upholstery - category C	1 478,00	1 800,00	96,00
Upholstery - category D	1 610,00	1 932,00	119,00
Upholstery - category E	1 941,00	2 263,00	177,00
Upholstery - category 1	1 856,00	2 178,00	162,00
Upholstery - category 2			
Upholstery - COM	1 283,00	1 605,00	62,00
<b>SURCHARGES IN € (VAT NOT INCLUDED)</b>			
Antique colour	78,00		
Pigment colours	104,00	104,00	
Foam BS 5852 Crib 5	62,00	62,00	8,00
<b>TECHNICAL INFORMATION</b>			
Total width (cm)	85-155/55-125	85-155/55-125	33,4
Total depth (cm)	58	58	20
Total height (cm)	131	131	18
Seat height (cm)	80	80	
Width of seat (cm)	85-155	85-155	
Depth of seat (cm)	40,5	40,5	
Weight of product (kg)	28,7-47,5	28,7-47,5	1,2
Consumption of fabric (m)	3,303	3,303	0,578
Consumption of leather (m <sup>2</sup> )	8,259	8,259	1,444
Packing (pcs)	1	1	1
Volume (m <sup>3</sup> /pc)	2,160	2,160	0,025
Carton dimensions (cm)			

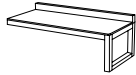
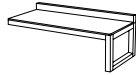

<b>PRODUCT NUMBER</b>	<b>4UI 530</b>	<b>4UI 530</b>
Type	side table	side table
	multiplex top	multiplex top
Type of wood	beech	oak
<b>PRICES IN € (VAT NOT INCLUDED)</b>		
	<b>1 087,00</b>	<b>1 264,00</b>

<b>SURCHARGES IN € (VAT NOT INCLUDED)</b>		
Antique colour	<b>66,00</b>	
Pigment colours	<b>126,00</b>	<b>126,00</b>

<b>TECHNICAL INFORMATION</b>		
Total width (cm)	120	120
Total depth (cm)	58	58
Total height (cm)	44	44
Seat height (cm)		
Width of seat (cm)		
Depth of seat (cm)		
Weight of product (kg)	18,7	18,7

Packing (pcs)	1	1
Volume (m <sup>3</sup> /pc)	0,927	0,927
Carton dimensions (cm)		

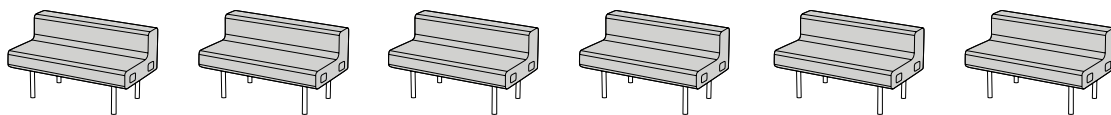

PRODUCT NUMBER	3S3 852	3S3 852	3S3 852	3S3 852	3S3 852	3S3 852
Type	module 80 cm	module 80 cm	module 90 cm	module 90 cm	module 100 cm	module 100 cm
Seat option	upholstery	upholstery	upholstery	upholstery	upholstery	upholstery
Back option	upholstery	upholstery	upholstery	upholstery	upholstery	upholstery
Type of wood	beech	oak	beech	oak	beech	oak
<b>PRICES IN € (VAT NOT INCLUDED)</b>						
Upholstery - category A	706,00	738,00	767,00	799,00	829,00	861,00
Upholstery - category B	748,00	780,00	815,00	847,00	882,00	914,00
Upholstery - category C	783,00	815,00	854,00	886,00	925,00	957,00
Upholstery - category D	860,00	892,00	940,00	972,00	1 021,00	1 053,00
Upholstery - category E	1 053,00	1 085,00	1 158,00	1 190,00	1 263,00	1 295,00
Upholstery - category 1	928,00	960,00	1 018,00	1 050,00	1 107,00	1 139,00
Upholstery - category 2						
Upholstery - COM	669,00	701,00	726,00	758,00	783,00	815,00
<b>SURCHARGES IN € (VAT NOT INCLUDED)</b>						
Antique colour	6,00		6,00		6,00	
Pigment colours	12,00	12,00	12,00	12,00	12,00	12,00
Foam BS 5852 Crib 5	37,00	37,00	41,00	41,00	45,00	45,00
<b>TECHNICAL INFORMATION</b>						
Total width (cm)	80	80	90	90	100	100
Total depth (cm)	65	65	65	65	65	65
Total height (cm)	70	70	70	70	70	70
Seat height (cm)	46	46	46	46	46	46
Width of seat (cm)	80	80	90	90	100	100
Depth of seat (cm)	45	45	45	45	45	45
Weight of product (kg)	16	16	17	17	18,5	18,5
Consumption of fabric (m)	1,925	1,925	2,166	2,166	2,407	2,407
Consumption of leather (m <sup>2</sup> )	3,850	3,850	4,332	4,332	4,813	4,813
Packing (pcs)	2	2	2	2	2	2
Volume (m <sup>3</sup> /pc)	0,790	0,790	0,884	0,884	0,978	0,978
Carton dimensions (cm)	84 × 44 × 89	84 × 44 × 89	94 × 44 × 89	94 × 44 × 89	104 × 44 × 89	104 × 44 × 89

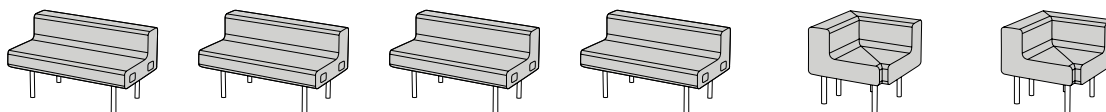

PRODUCT NUMBER	3S3 852	3S3 852	383 852	383 852	383 853	383 853
Type	module 120 cm	module 120 cm	bench made to measure	bench made to measure	corner bench	corner bench
			price per running metre	price per running metre		
Seat option	upholstery	upholstery	upholstery	upholstery	upholstery	upholstery
Back option	upholstery	upholstery	upholstery	upholstery	upholstery	upholstery
Type of wood	beech	oak	beech	oak	beech	oak
<b>PRICES IN € (VAT NOT INCLUDED)</b>						
Upholstery - category A	915,00	947,00	868,00	900,00	955,00	987,00
Upholstery - category B	978,00	1 010,00	921,00	953,00	1 016,00	1 048,00
Upholstery - category C	1 030,00	1 062,00	965,00	997,00	1 066,00	1 098,00
Upholstery - category D	1 146,00	1 178,00	1 061,00	1 093,00	1 177,00	1 209,00
Upholstery - category E	1 435,00	1 467,00	1 302,00	1 334,00	1 455,00	1 487,00
Upholstery - category 1	1 249,00	1 281,00	1 147,00	1 179,00	1 383,00	1 415,00
Upholstery - category 2						
Upholstery - COM	860,00	892,00	823,00	855,00	903,00	935,00
<b>SURCHARGES IN € (VAT NOT INCLUDED)</b>						
Antique colour	6,00		6,00		6,00	
Pigment colours	12,00	12,00	12,00	12,00	12,00	12,00
Foam BS 5852 Crib 5	54,00	54,00	45,00	45,00	53,00	53,00
<b>TECHNICAL INFORMATION</b>						
Total width (cm)	120	120	80-120	80-120	70	70
Total depth (cm)	65	65	65	65	70	70
Total height (cm)	70	70	70	70	70	70
Seat height (cm)	46	46	46	46	46	46
Width of seat (cm)	120	120	80-120	80-120		
Depth of seat (cm)	45	45	45	45	45	45
Weight of product (kg)	21	21	16-21	16-21	23	23
Consumption of fabric (m)	2,888	2,888	2,407	2,407	2,772	2,772
Consumption of leather (m <sup>2</sup> )	5,775	5,775	4,813	4,813	6,930	6,930
Packing (pcs)	2	2	2	2	1	1
Volume (m <sup>3</sup> /pc)	1,166	1,166	0,978	0,978	0,579	0,579
Carton dimensions (cm)	124 × 44 × 89	124 × 44 × 89	104 × 44 × 89	104 × 44 × 89	74 × 44 × 74	74 × 44 × 74

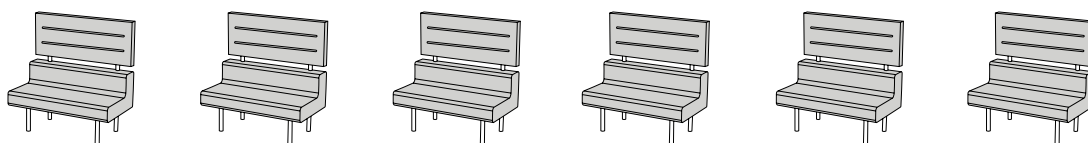

PRODUCT NUMBER	3S3 852	3S3 852	3S3 852	3S3 852	3S3 852	3S3 852
Type	module 80 cm	module 80 cm	module 90 cm	module 90 cm	module 100 cm	module 100 cm
	backrest panel L	backrest panel L	backrest panel L	backrest panel L	backrest panel L	backrest panel L
Seat option	upholstery	upholstery	upholstery	upholstery	upholstery	upholstery
Back option	upholstery	upholstery	upholstery	upholstery	upholstery	upholstery
Type of wood	beech	oak	beech	oak	beech	oak
<b>PRICES IN € (VAT NOT INCLUDED)</b>						
Upholstery - category A	993,00	1 025,00	1 071,00	1 103,00	1 146,00	1 178,00
Upholstery - category B	1 062,00	1 094,00	1 149,00	1 181,00	1 232,00	1 264,00
Upholstery - category C	1 118,00	1 150,00	1 212,00	1 244,00	1 303,00	1 335,00
Upholstery - category D	1 244,00	1 276,00	1 354,00	1 386,00	1 460,00	1 492,00
Upholstery - category E	1 559,00	1 591,00	1 708,00	1 740,00	1 854,00	1 886,00
Upholstery - category 1	1 356,00	1 388,00	1 480,00	1 512,00	1 600,00	1 632,00
Upholstery - category 2						
Upholstery - COM	933,00	965,00	1 004,00	1 036,00	1 071,00	1 103,00
<b>SURCHARGES IN € (VAT NOT INCLUDED)</b>						
Antique colour	6,00		6,00		6,00	
Pigment colours	12,00	12,00	12,00	12,00	12,00	12,00
Foam BS 5852 Crib 5	62,00	62,00	69,00	69,00	77,00	77,00
<b>TECHNICAL INFORMATION</b>						
Total width (cm)	80	80	90	90	100	100
Total depth (cm)	65	65	65	65	65	65
Total height (cm)	124	124	124	124	124	124
Seat height (cm)	46	46	46	46	46	46
Width of seat (cm)	80	80	90	90	100	100
Depth of seat (cm)	45	45	45	45	45	45
Weight of product (kg)	23	23	24	24	25,5	25,5
Consumption of fabric (m)	3,142	3,142	3,534	3,534	3,927	3,927
Consumption of leather (m <sup>2</sup> )	6,283	6,283	7,069	7,069	7,854	7,854
Packing (pcs)	2	2	2	2	2	2
Volume (m <sup>3</sup> /pc)	0,790	0,790	0,884	0,884	0,978	0,978
Carton dimensions (cm)	84 × 44 × 89	84 × 44 × 89	94 × 44 × 89	94 × 44 × 89	104 × 44 × 89	104 × 44 × 89
	94 × 84 × 13	94 × 84 × 13	94 × 94 × 13	94 × 94 × 13	104 × 94 × 13	104 × 94 × 13



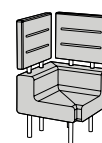
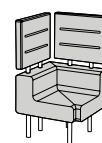
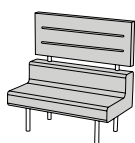
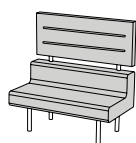
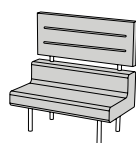

PRODUCT NUMBER	3S3 852	3S3 852	383 852	383 852	383 853	383 853
Type	module 120 cm	module 120 cm	bench made to measure	bench made to measure	corner bench	corner bench
	backrest panel L	backrest panel L	backrest panel L	backrest panel L	backrest panel L	backrest panel L
Seat option	upholstery	upholstery	upholstery	upholstery	upholstery	upholstery
Back option	upholstery	upholstery	upholstery	upholstery	upholstery	upholstery
Type of wood	beech	oak	beech	oak	beech	oak
<b>PRICES IN € (VAT NOT INCLUDED)</b>						
Upholstery - category A	1 241,00	1 273,00	1 185,00	1 217,00	1 529,00	1 561,00
Upholstery - category B	1 345,00	1 377,00	1 272,00	1 304,00	1 683,00	1 715,00
Upholstery - category C	1 430,00	1 462,00	1 342,00	1 374,00	1 809,00	1 841,00
Upholstery - category D	1 618,00	1 650,00	1 499,00	1 531,00	2 088,00	2 120,00
Upholstery - category E	2 091,00	2 123,00	1 893,00	1 925,00	2 787,00	2 819,00
Upholstery - category 1	1 787,00	1 819,00	1 640,00	1 672,00	2 607,00	2 639,00
Upholstery - category 2						
Upholstery - COM	1 152,00	1 184,00	1 111,00	1 143,00	1 397,00	1 429,00
<b>SURCHARGES IN € (VAT NOT INCLUDED)</b>						
Antique colour	6,00		6,00		6,00	
Pigment colours	12,00	12,00	12,00	12,00	12,00	12,00
Foam BS 5852 Crib 5	92,00	92,00	77,00	77,00	135,00	135,00
<b>TECHNICAL INFORMATION</b>						
Total width (cm)	120	120	80-120	80-120	70	70
Total depth (cm)	65	65	65	65	70	70
Total height (cm)	124	124	124	124	124	124
Seat height (cm)	46	46	46	46	46	46
Width of seat (cm)	120	120	80-120	80-120		
Depth of seat (cm)	45	45	45	45	45	45
Weight of product (kg)	29	29	23-29	23-29	34	34
Consumption of fabric (m)	4,712	4,712	3,927	3,927	6,976	6,976
Consumption of leather (m <sup>2</sup> )	9,425	9,425	7,854	7,854	17,442	17,442
Packing (pcs)	2	2	2	2	1	1
Volume (m <sup>3</sup> /pc)	1,166	1,166	0,978	0,978	0,579	0,579
Carton dimensions (cm)	124 × 44 × 89	124 × 44 × 89	104 × 44 × 89	104 × 44 × 89	74 × 44 × 74	74 × 44 × 74
	124 × 94 × 13	124 × 94 × 13	104 × 94 × 13	104 × 94 × 13	94 × 64 × 13	94 × 64 × 13

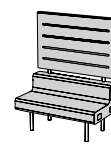
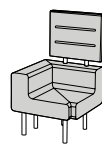
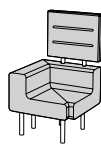
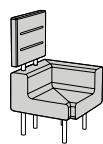
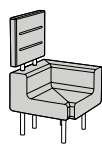

PRODUCT NUMBER	383 853	383 853	383 853	383 853	3S3 852	3S3 852
Type	corner bench	corner bench	corner bench	corner bench	module 80 cm	module 80 cm
	backrest panel L1	backrest panel L1	backrest panel L2	backrest panel L2	backrest panel H	backrest panel H
Seat option	upholstery	upholstery	upholstery	upholstery	upholstery	upholstery
Back option	upholstery	upholstery	upholstery	upholstery	upholstery	upholstery
Type of wood	beech	oak	beech	oak	beech	oak
<b>PRICES IN € (VAT NOT INCLUDED)</b>						
Upholstery - category A	1 242,00	1 274,00	1 242,00	1 274,00	1 083,00	1 115,00
Upholstery - category B	1 350,00	1 382,00	1 350,00	1 382,00	1 159,00	1 191,00
Upholstery - category C	1 437,00	1 469,00	1 437,00	1 469,00	1 221,00	1 253,00
Upholstery - category D	1 632,00	1 664,00	1 632,00	1 664,00	1 360,00	1 392,00
Upholstery - category E	2 121,00	2 153,00	2 121,00	2 153,00	1 708,00	1 740,00
Upholstery - category 1	1 995,00	2 027,00	1 995,00	2 027,00	1 484,00	1 516,00
Upholstery - category 2						
Upholstery - COM	1 150,00	1 182,00	1 150,00	1 182,00	1 017,00	1 049,00
<b>SURCHARGES IN € (VAT NOT INCLUDED)</b>						
Antique colour	6,00		6,00		6,00	
Pigment colours	12,00	12,00	12,00	12,00	12,00	12,00
Foam BS 5852 Crib 5	94,00	94,00	94,00	94,00	68,00	68,00
<b>TECHNICAL INFORMATION</b>						
Total width (cm)	70	70	70	70	80	80
Total depth (cm)	70	70	70	70	65	65
Total height (cm)	124	124	124	124	155	155
Seat height (cm)	46	46	46	46	46	46
Width of seat (cm)					80	80
Depth of seat (cm)	45	45	45	45	45	45
Weight of product (kg)	28,5	28,5	28,5	28,5	27	27
Consumption of fabric (m)	4,874	4,874	4,874	4,874	3,465	3,465
Consumption of leather (m <sup>2</sup> )	12,186	12,186	12,186	12,186	6,930	6,930
Packing (pcs)	1	1	1	1	2	2
Volume (m <sup>3</sup> /pc)	0,579	0,579	0,579	0,579	0,790	0,790
Carton dimensions (cm)	74 × 44 × 74	74 × 44 × 74	74 × 44 × 74	74 × 44 × 74	84 × 44 × 89	84 × 44 × 89
	94 × 64 × 13	94 × 64 × 13	94 × 64 × 13	94 × 64 × 13	125 × 84 × 13	125 × 84 × 13

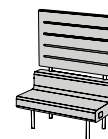
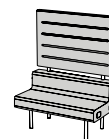
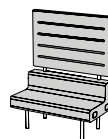
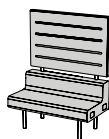
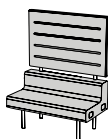
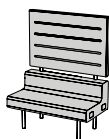

PRODUCT NUMBER	3S3 852	3S3 852	3S3 852	3S3 852	3S3 852	3S3 852
Type	module 90 cm	module 90 cm	module 100 cm	module 100 cm	module 120 cm	module 120 cm
	backrest panel H	backrest panel H	backrest panel H	backrest panel H	backrest panel H	backrest panel H
Seat option	upholstery	upholstery	upholstery	upholstery	upholstery	upholstery
Back option	upholstery	upholstery	upholstery	upholstery	upholstery	upholstery
Type of wood	beech	oak	beech	oak	beech	oak
<b>PRICES IN € (VAT NOT INCLUDED)</b>						
Upholstery - category A	1 176,00	1 208,00	1 268,00	1 300,00	1 370,00	1 402,00
Upholstery - category B	1 262,00	1 294,00	1 363,00	1 395,00	1 484,00	1 516,00
Upholstery - category C	1 332,00	1 364,00	1 441,00	1 473,00	1 578,00	1 610,00
Upholstery - category D	1 488,00	1 520,00	1 614,00	1 646,00	1 786,00	1 818,00
Upholstery - category E	1 879,00	1 911,00	2 049,00	2 081,00	2 307,00	2 339,00
Upholstery - category 1	1 628,00	1 660,00	1 769,00	1 801,00	1 971,00	2 003,00
Upholstery - category 2						
Upholstery - COM	1 102,00	1 134,00	1 185,00	1 217,00	1 271,00	1 303,00
<b>SURCHARGES IN € (VAT NOT INCLUDED)</b>						
Antique colour	6,00		6,00		6,00	
Pigment colours	12,00	12,00	12,00	12,00	12,00	12,00
Foam BS 5852 Crib 5	75,00	75,00	84,00	84,00	101,00	101,00
<b>TECHNICAL INFORMATION</b>						
Total width (cm)	90	90	100	100	120	120
Total depth (cm)	65	65	65	65	65	65
Total height (cm)	155	155	155	155	155	155
Seat height (cm)	46	46	46	46	46	46
Width of seat (cm)	90	90	100	100	120	120
Depth of seat (cm)	45	45	45	45	45	45
Weight of product (kg)	28	28	29,5	29,5	32,5	32,5
Consumption of fabric (m)	3,898	3,898	4,332	4,332	5,198	5,198
Consumption of leather (m <sup>2</sup> )	7,797	7,797	8,663	8,663	10,395	10,395
Packing (pcs)	2	2	2	2	2	2
Volume (m <sup>3</sup> /pc)	0,884	0,884	0,978	0,978	1,166	1,166
Carton dimensions (cm)	94 × 44 × 89	94 × 44 × 89	104 × 44 × 89	104 × 44 × 89	124 × 44 × 89	124 × 44 × 89
	125 × 94 × 13	125 × 94 × 13	125 × 104 × 13	125 × 104 × 13	125 × 125 × 13	125 × 125 × 13

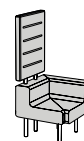
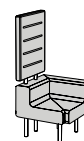
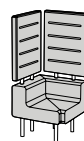
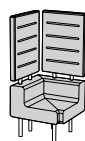
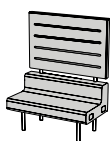

PRODUCT NUMBER	383 852	383 852	383 853	383 853	383 853	383 853
Type	bench made to measure	bench made to measure	corner bench	corner bench	corner bench	corner bench
	backrest panel H	backrest panel H	backrest panel H	backrest panel H	backrest panel H1	backrest panel H1
Seat option	upholstery	upholstery	upholstery	upholstery	upholstery	upholstery
Back option	upholstery	upholstery	upholstery	upholstery	upholstery	upholstery
Type of wood	beech	oak	beech	oak	beech	oak
<b>PRICES IN € (VAT NOT INCLUDED)</b>						
Upholstery - category A	1 307,00	1 339,00	1 693,00	1 725,00	1 324,00	1 356,00
Upholstery - category B	1 403,00	1 435,00	1 874,00	1 906,00	1 445,00	1 477,00
Upholstery - category C	1 481,00	1 513,00	2 022,00	2 054,00	1 544,00	1 576,00
Upholstery - category D	1 654,00	1 686,00	2 352,00	2 384,00	1 764,00	1 796,00
Upholstery - category E	2 088,00	2 120,00	3 178,00	3 210,00	2 316,00	2 348,00
Upholstery - category 1	1 809,00	1 841,00	2 964,00	2 996,00	2 174,00	2 206,00
Upholstery - category 2						
Upholstery - COM	1 225,00	1 257,00	1 537,00	1 569,00	1 219,00	1 251,00
<b>SURCHARGES IN € (VAT NOT INCLUDED)</b>						
Antique colour	6,00		6,00		6,00	
Pigment colours	12,00	12,00	12,00	12,00	12,00	12,00
Foam BS 5852 Crib 5	84,00	84,00	159,00	159,00	106,00	106,00
<b>TECHNICAL INFORMATION</b>						
Total width (cm)	80-120	80-120	70	70	70	70
Total depth (cm)	65	65	70	70	70	70
Total height (cm)	155	155	155	155	155	155
Seat height (cm)	46	46	46	46	46	46
Width of seat (cm)	80-120	80-120				
Depth of seat (cm)	45	45	45	45	45	45
Weight of product (kg)	27-32,5	27-32,5	39	39	31	31
Consumption of fabric (m)	4,332	4,332	8,235	8,235	5,503	5,503
Consumption of leather (m <sup>2</sup> )	8,663	8,663	20,585	20,585	13,758	13,758
Packing (pcs)	2	2	1	1	1	1
Volume (m <sup>3</sup> /pc)	0,978	0,978	0,579	0,579	0,579	0,579
Carton dimensions (cm)	104 × 44 × 89	104 × 44 × 89	74 × 44 × 74	74 × 44 × 74	74 × 44 × 74	74 × 44 × 74
	125 × 104 × 13	125 × 104 × 13	125 × 64 × 13	125 × 64 × 13	125 × 64 × 13	125 × 64 × 13

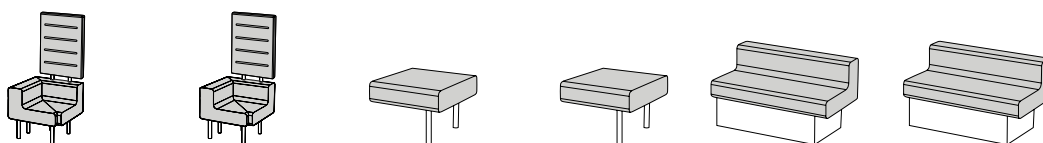

PRODUCT NUMBER	383 853	383 853	383 854	383 854	3S3 855	3S3 855
Type	corner bench	corner bench	end-of-row bench	end-of-row bench	module 80 cm	module 90 cm
	backrest panel H2	backrest panel H2				
Seat option	upholstery	upholstery	upholstery	upholstery	upholstery	upholstery
Back option	upholstery	upholstery			upholstery	upholstery
Type of wood	beech	oak	beech	oak		
<b>PRICES IN € (VAT NOT INCLUDED)</b>						
Upholstery - category A	1 324,00	1 356,00	347,00	363,00	741,00	819,00
Upholstery - category B	1 445,00	1 477,00	366,00	382,00	783,00	867,00
Upholstery - category C	1 544,00	1 576,00	382,00	398,00	818,00	906,00
Upholstery - category D	1 764,00	1 796,00	416,00	432,00	895,00	992,00
Upholstery - category E	2 316,00	2 348,00	503,00	519,00	1 088,00	1 210,00
Upholstery - category 1	2 174,00	2 206,00	481,00	497,00	963,00	1 070,00
Upholstery - category 2						
Upholstery - COM	1 219,00	1 251,00	331,00	347,00	704,00	778,00
<b>SURCHARGES IN € (VAT NOT INCLUDED)</b>						
Antique colour	6,00		4,00			
Pigment colours	12,00	12,00	7,00	7,00		
Foam BS 5852 Crib 5	106,00	106,00	17,00	17,00	37,00	41,00
<b>TECHNICAL INFORMATION</b>						
Total width (cm)	70	70	60	60	80	90
Total depth (cm)	70	70	65	65	65	65
Total height (cm)	155	155	46	46	70	70
Seat height (cm)	46	46	46	46	46	46
Width of seat (cm)			60	60	80	90
Depth of seat (cm)	45	45	65	65	45	45
Weight of product (kg)	31	31	8	8	26	27
Consumption of fabric (m)	5,503	5,503	0,867	0,867	1,925	2,166
Consumption of leather (m <sup>2</sup> )	13,758	13,758	2,166	2,166	3,850	4,332
Packing (pcs)	1	1	1	1	1	1
Volume (m <sup>3</sup> /pc)	0,579	0,579	0,212	0,212	0,950	1,066
Carton dimensions (cm)	74 × 44 × 74	74 × 44 × 74	64 × 20 × 69	64 × 20 × 69	82 × 67 × 72	92 × 67 × 72
	125 × 64 × 13	125 × 64 × 13				

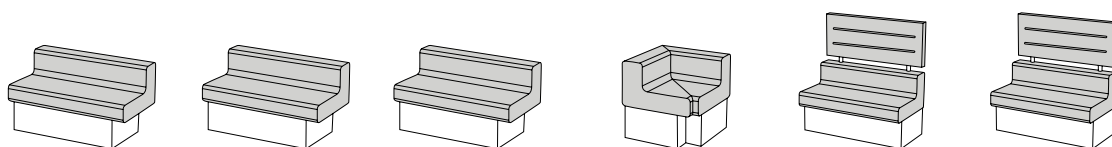

PRODUCT NUMBER	3S3 855	3S3 855	383 855	383 856	3S3 855	3S3 855
Type	module 100 cm	module 120 cm	bench made to measure	corner bench	module 80 cm	module 90 cm
			price per running metre		backrest panel L	backrest panel L
Seat option	upholstery	upholstery	upholstery	upholstery	upholstery	upholstery
Back option	upholstery	upholstery	upholstery	upholstery	upholstery	upholstery
Type of wood						
<b>PRICES IN € (VAT NOT INCLUDED)</b>						
Upholstery - category A	896,00	997,00	954,00	987,00	1 028,00	1 123,00
Upholstery - category B	949,00	1 060,00	1 007,00	1 048,00	1 097,00	1 201,00
Upholstery - category C	992,00	1 112,00	1 051,00	1 098,00	1 153,00	1 264,00
Upholstery - category D	1 088,00	1 228,00	1 147,00	1 209,00	1 279,00	1 406,00
Upholstery - category E	1 330,00	1 517,00	1 388,00	1 487,00	1 594,00	1 760,00
Upholstery - category 1	1 174,00	1 331,00	1 233,00	1 415,00	1 391,00	1 532,00
Upholstery - category 2						
Upholstery - COM	850,00	942,00	909,00	935,00	968,00	1 056,00
<b>SURCHARGES IN € (VAT NOT INCLUDED)</b>						
Antique colour						
Pigment colours						
Foam BS 5852 Crib 5	45,00	54,00	45,00	53,00	62,00	69,00
<b>TECHNICAL INFORMATION</b>						
Total width (cm)	100	120	80-120	70	80	90
Total depth (cm)	65	65	65	70	65	65
Total height (cm)	70	70	70	70	124	124
Seat height (cm)	46	46	46	46	46	46
Width of seat (cm)	100	120	80-120		80	90
Depth of seat (cm)	45	45	45	45	45	45
Weight of product (kg)	28,5	31	26-31	33	33	34
Consumption of fabric (m)	2,407	2,888	2,407	2,772	3,142	3,534
Consumption of leather (m <sup>2</sup> )	4,813	5,775	4,813	6,930	6,283	7,069
Packing (pcs)	1	1	1	1	1	1
Volume (m <sup>3</sup> /pc)	1,181	1,413	1,181	0,896	0,950	1,066
Carton dimensions (cm)	102 × 67 × 72	122 × 67 × 72	102 × 67 × 72	72 × 72 × 72	82 × 67 × 72	92 × 67 × 72
					94 × 84 × 13	94 × 94 × 13

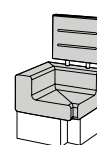
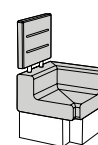
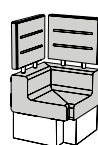
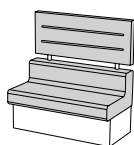
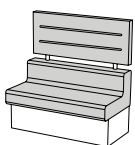
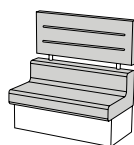

PRODUCT NUMBER	3S3 855	3S3 855	383 855	383 856	383 856	383 856
Type	module 100 cm	module 120 cm	bench made to measure	corner bench	corner bench	corner bench
	backrest panel L	backrest panel L	backrest panel L	backrest panel L	backrest panel L1	backrest panel L2
Seat option	upholstery	upholstery	upholstery	upholstery	upholstery	upholstery
Back option	upholstery	upholstery	upholstery	upholstery	upholstery	upholstery
Type of wood						
<b>PRICES IN € (VAT NOT INCLUDED)</b>						
Upholstery - category A	1 213,00	1 323,00	1 271,00	1 561,00	1 274,00	1 274,00
Upholstery - category B	1 299,00	1 427,00	1 358,00	1 715,00	1 382,00	1 382,00
Upholstery - category C	1 370,00	1 512,00	1 428,00	1 841,00	1 469,00	1 469,00
Upholstery - category D	1 527,00	1 700,00	1 585,00	2 120,00	1 664,00	1 664,00
Upholstery - category E	1 921,00	2 173,00	1 979,00	2 819,00	2 153,00	2 153,00
Upholstery - category 1	1 667,00	1 869,00	1 726,00	2 639,00	2 027,00	2 027,00
Upholstery - category 2						
Upholstery - COM	1 138,00	1 234,00	1 197,00	1 429,00	1 182,00	1 182,00
<b>SURCHARGES IN € (VAT NOT INCLUDED)</b>						
Antique colour						
Pigment colours						
Foam BS 5852 Crib 5	77,00	92,00	77,00	135,00	94,00	94,00
<b>TECHNICAL INFORMATION</b>						
Total width (cm)	100	120	80-120	70	70	70
Total depth (cm)	65	65	65	70	70	70
Total height (cm)	124	124	124	124	124	124
Seat height (cm)	46	46	46	46	46	46
Width of seat (cm)	100	120	80-120			
Depth of seat (cm)	45	45	45	45	45	45
Weight of product (kg)	35,5	38	33-38	44	38,5	38,5
Consumption of fabric (m)	3,927	4,712	3,927	6,976	4,874	4,874
Consumption of leather (m <sup>2</sup> )	7,854	9,425	7,854	17,442	12,186	12,186
Packing (pcs)	1	1	1	1	1	1
Volume (m <sup>3</sup> /pc)	1,181	1,413	1,181	0,896	0,896	0,896
Carton dimensions (cm)	102 × 67 × 72	122 × 67 × 72	102 × 67 × 72	72 × 72 × 72	72 × 72 × 72	72 × 72 × 72
	104 × 94 × 13	124 × 94 × 13	104 × 94 × 13	94 × 64 × 13	94 × 64 × 13	94 × 64 × 13

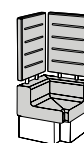
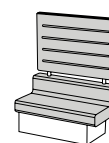
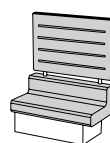
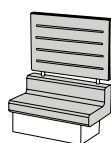
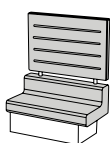
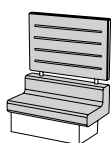

PRODUCT NUMBER	3S3 855	3S3 855	3S3 855	3S3 855	383 855	383 856
Type	module 80 cm	module 90 cm	module 100 cm	module 120 cm	bench made to measure	corner bench
	backrest panel H	backrest panel H	backrest panel H	backrest panel H	backrest panel H	backrest panel H
Seat option	upholstery	upholstery	upholstery	upholstery	upholstery	upholstery
Back option	upholstery	upholstery	upholstery	upholstery	upholstery	upholstery
Type of wood						
<b>PRICES IN € (VAT NOT INCLUDED)</b>						
Upholstery - category A	1 118,00	1 228,00	1 335,00	1 452,00	1 393,00	1 725,00
Upholstery - category B	1 194,00	1 314,00	1 430,00	1 566,00	1 489,00	1 906,00
Upholstery - category C	1 256,00	1 384,00	1 508,00	1 660,00	1 567,00	2 054,00
Upholstery - category D	1 395,00	1 540,00	1 681,00	1 868,00	1 740,00	2 384,00
Upholstery - category E	1 743,00	1 931,00	2 116,00	2 389,00	2 174,00	3 210,00
Upholstery - category 1	1 519,00	1 680,00	1 836,00	2 053,00	1 895,00	2 996,00
Upholstery - category 2						
Upholstery - COM	1 052,00	1 154,00	1 252,00	1 353,00	1 311,00	1 569,00
<b>SURCHARGES IN € (VAT NOT INCLUDED)</b>						
Antique colour						
Pigment colours						
Foam BS 5852 Crib 5	68,00	75,00	84,00	101,00	84,00	159,00
<b>TECHNICAL INFORMATION</b>						
Total width (cm)	80	90	100	120	80-120	70
Total depth (cm)	65	65	65	65	65	70
Total height (cm)	155	155	155	155	155	155
Seat height (cm)	46	46	46	46	46	46
Width of seat (cm)	80	90	100	120	80-120	
Depth of seat (cm)	45	45	45	45	45	45
Weight of product (kg)	37	38	39,5	42	37-42	49
Consumption of fabric (m)	3,465	3,898	4,332	5,198	4,332	8,235
Consumption of leather (m <sup>2</sup> )	6,930	7,797	8,663	10,395	8,663	20,585
Packing (pcs)	1	1	1	1	1	1
Volume (m <sup>3</sup> /pc)	0,950	1,066	1,181	1,413	1,181	0,896
Carton dimensions (cm)	82 × 67 × 72	92 × 67 × 72	102 × 67 × 72	122 × 67 × 72	102 × 67 × 72	72 × 72 × 72
	125 × 84 × 13	125 × 94 × 13	125 × 104 × 13	125 × 125 × 13	125 × 104 × 13	125 × 64 × 13



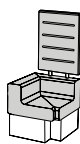
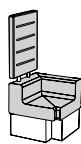

PRODUCT NUMBER	383 856	383 856	383 857	309 254	309 255
Type	corner bench	corner bench	end-of-row bench	cushion	armrest
	backrest panel H1	backrest panel H2			
Seat option	upholstery	upholstery	upholstery		
Back option	upholstery	upholstery			
Type of wood					
<b>PRICES IN € (VAT NOT INCLUDED)</b>					
Upholstery - category A	1 356,00	1 356,00	380,00	68,00	176,00
Upholstery - category B	1 477,00	1 477,00	399,00	80,00	201,00
Upholstery - category C	1 576,00	1 576,00	415,00	91,00	221,00
Upholstery - category D	1 796,00	1 796,00	449,00	114,00	265,00
Upholstery - category E	2 348,00	2 348,00	536,00	172,00	376,00
Upholstery - category 1	2 206,00	2 206,00	514,00	157,00	348,00
Upholstery - category 2					
Upholstery - COM	1 251,00	1 251,00	364,00	57,00	155,00
<b>SURCHARGES IN € (VAT NOT INCLUDED)</b>					
Antique colour					
Pigment colours					
Foam BS 5852 Crib 5	106,00	106,00	17,00	8,00	15,00
<b>TECHNICAL INFORMATION</b>					
Total width (cm)	70	70	60	36	65
Total depth (cm)	70	70	65	14,5	8,5
Total height (cm)	155	155	46	20	40
Seat height (cm)	46	46	46		
Width of seat (cm)			60		
Depth of seat (cm)	45	45	65		
Weight of product (kg)	41	41	13	1,2	6
Consumption of fabric (m)	5,503	5,503	0,867	0,578	1,109
Consumption of leather (m <sup>2</sup> )	13,758	13,758	2,166	1,444	2,772
Packing (pcs)	1	1	1	1	1
Volume (m <sup>3</sup> /pc)	0,896	0,896	0,479	0,023	0,047
Carton dimensions (cm)	72 × 72 × 72	72 × 72 × 72	62 × 67 × 48		
	125 × 64 × 13	125 × 64 × 13			





**further information**

# general terms and conditions

■ Click on this [link](#) for detailed information.

## furniture care & maintenance

Thank you for purchasing a TON product. The mission of TON is to make products that meet the highest demands for design, quality and functionality. This is also documented by numerous awards our products won on domestic as well as foreign markets.

Our product development and manufacture are based on principles of the original manufacturing technology of manual bending, tested by years of tradition and enhanced with the newest knowledge in the areas of

design and other manufacturing technologies. Every product undergoes a specific stress test in compliance with European standard EN 16139 Furniture – Strength, Durability and Safety. Most of our products are made of natural materials such as wood, cane weave, leather, wool, cotton etc. The natural origin of our products is manifested by colour alterations, growth defects of wood or leather, changes in wood texture or micro cracks, folds or waves in leather and fabrics. These are

no defects, rather the contrary. Every TON product is an original unique piece of furniture made by human hands. You can be sure that no one else will have the same TON chair as you.

Regular professional care extends the life of any product, thus increasing your satisfaction with its use. Let us inform you how to best use TON products and how to take care of them.

### Ambient environment

Just like people are harmed by extreme environmental effects, so is furniture made of natural materials. Non-standard relative humidity (lower than 40 % or, on the other hand, higher than 60 %) can negatively affect the product, causing shape deformation, damage to the upholstery or cane. If the product is exposed to direct

sunshine or another heat source (fireplace, stove, heating radiator etc.), its colour may change, its wooden, cane or leather parts may crack etc. This is a common phenomenon that occurs commonly in the natural environment you live in. Surroundings include also claws of your pets, metal parts of clothes and hard seams,

kitchen knives and other sharp objects which, when used without proper attention, may cause scratches and other damage to the surface of wood or leather, tears in a fabric or cane weave etc.

### Wooden parts

Every piece of wood has its unique character and texture, which means that there are no two absolutely identical products and that identical appearance of two table top and additional panels cannot be guaranteed. Also knots and pith rays are common features of naturally growing material. Our products may contain small healthy knots which document the natural origin of the material.

The very structure of wood and its processing is a cause of different reactions of the individual parts to dyes and finishing materials. Steaming causes the characteristic pinkish colour of beech wood, which may mainly be seen in the light-stained shades. Steaming also changes wood properties of veneer, therefore veneers and solid wood react differently to dyeing, staining and finishing materials. UV radiation may cause colour differences between solid wood and veneered parts of the same product. Also dye oxidation caused by UV radiation will be different on a table top and a less frequently used or hidden insert panel. These changes cannot be subject to claim.

Wood as a natural material constantly breathes and reacts to the ambient environment. As a result, micro cracks may appear in the lacquer or the wood texture may slightly surface in the course of life of the wooden product. Liquids act negatively on the surface, soaking through may cause stains or glass bottom prints. Therefore, all spilled liquids should be wiped dry immediately. Lacquered or oiled surface can also change colour or get damaged by placing a hot pot on the table top. This unwanted effect may be prevented by careful handling and use of insulating mats under hot pots or bowls. Another natural reaction to the environment is shape deviation in products with manually bent wooden parts.

For this reason, a dimension tolerance of  $\pm 2$  cm is defined for the leg spacing of every bent furniture product. The bent parts may also be stressed by transport, which may result in slight wobble of the product. This is not a product defect, as this condition is remedied by sitting on it. Tolerance of  $\pm 3$  mm is defined for solid wood table top to account for environmental effects. This tolerance also applies to the connection of the table top to the additional folding panel.

#### Treatment of lacquered tops

Lacquered surface finish does not usually require special maintenance. Dust wooden parts of the product with a soft, clean and dry duster of lint-free material (cotton, linen, buckskin). When dusting the furniture, do not press hard on the duster to avoid irreversible polishing of the surface. Wipe off spilled liquids immediately. Do not let large stains dry on the surface but remove them immediately with a moistened cotton cloth and then wipe the treated area dry. Cleaning and treatment with special furniture detergents is not necessary. However, if you do use them, you should follow instructions for use by their manufacturers and test them first on a less visible area.

! Never use concentrates or abrasive detergents (abrasive and polishing paste, powders) as they might scratch and damage the lacquered surface. Never use furniture polish or other products containing oils or waxes on a matt surface as they would produce uneven glossy stains on the surface.

#### Oiled surface treatment

Oiled surface finish requires regular care and preventive careful use. Dust wooden parts of the product with a soft, clean and dry duster of lint-free material (cotton, linen). Dry spilled liquids from the surface immediately with a textile or paper towel; do not smear the liquid on the surface unnecessarily. Then wipe the surface with a well wrung out cloth in the direction of the wood fibre and dry immediately. Do not let large stains dry on the surface but remove immediately and wipe the area using the same procedure.

It is recommended to check oiled furniture regularly and treat it with a new oil layer when necessary. Wood may absorb oil unevenly during manufacturing and therefore the surface may be rougher to the touch or porous in places. The oil itself also naturally dries out. Rough and abraded spots, glossy edges, stains, minor scratches, dirt from shoes etc. can be repaired by a new oil layer. If you use a furniture treatment set recommended by the furniture manufacturer, follow the instructions for use carefully. If you use any other commercially available product for oiled surface treatment, follow its manufacturer's instructions and test the product first on a less visible area.

How to proceed with oiling can also be found in the video tutorials on our [website](#).

! Never use concentrates or abrasive detergents (abrasive and polishing paste, powders) as they might scratch and damage the oiled surface.

### Upholstered parts

The texture of the fabrics used for furniture upholstery is different from the texture of the fabrics used for clothes and cannot be washed in most cases. Sunshine, radiant heat sources, or cold dry air generated by air conditioners cause drying of the fibre, which deprives the fibres from their flexibility, firmness and colour stability. Dust and sand particles are abrasive materials damaging the fibre. Sweat, skin grease or substances contained in cosmetic products can stain the fabric surface or react with the pigments used for the fabric dyeing. These ef-

fects, unlike staining with liquids, can act unnoticed but may contribute to accelerated ageing of the material. During upholstery or subsequent use, moderate waving or folding of the upholstery material may occur. In the course of the product use, mutual rubbing of materials against each other may cause piling on the most stressed parts of the upholstered surface. These changes are given by the properties of the upholstery material or by the used upholstery technology and cannot be subject to claim.

Light shades of fabrics, artificial or natural leathers, can be stained when in contact with other materials (non-colourfast textiles, denim, newspapers, magazines etc.). This staining, caused by chemical reactions of colour pigments, is not a sign of low quality of the upholstery materials and cannot be subject to claim.

Natural leather is a very popular upholstery material as it is soft and warm to the touch, has a pleasant characteristic smell and is wear resistant. Its quality depends on the animal's lifestyle as well as on the method of the leather

processing. Minor defects originating during the animal's life, such as wrinkles, blood veins, scars, scratches etc. are regarded as permissible and are even required as an evidence of the 'genuine and unique' quality of the leather. Unacceptable defects include deep scratches, burnt marks, thin leather and processing related defects.

### Fabric and artificial leather treatment

Remove dust regularly with a vacuum cleaner with fine suction force and then comb the surface with a soft brush in the pile direction. Wipe the fabrics from time to time with a moistened white cotton cloth or buckskin to prevent excessive drying of the fibre by dry air in the room. Dry spilled liquids from the surface immediately with a white cotton or paper towel; do not smear the liquid on the surface unnecessarily. Do not let coarse impurities dry on the surface but remove them immediately with a dull object (such as a spoon). Finer impurities can be cleaned with lukewarm water (up to 30 °C) with a non-aggressive washing detergent. Do not scrub stains but wipe them off carefully with a moistened sponge. Wipe the stains from the edge towards the centre (or in the pile direction) to avoid making them larger. Do not press the solution to the fabric so as not to wet it excessively. Dry excessive moisture with a dry cloth again. Let the surface dry in room temperature, do not dry it in the sun, near

heat sources, by hair dryers etc. Comb the dry fabric with a soft brush in the pile direction. In case of a stubborn stain, use dry foam, an upholstery cleaner or a chemical cleaner, as directed by the symbol shown on the fabric. Always test cleaning products on a hidden or not very visible part of the upholstery. Foam shampooing should carefully follow the instructions of the detergent manufacturer. If you do not want to risk in-house cleaning or do not know how to do it, ask a specialised company. Pilling may be removed by brushing with a fine brush. Synthetic fibre is firmer and therefore pilling may be removed by careful cutting off with scissors or by means of special blades. Never tear the pilling off the fabric by force. There is no guarantee that the pilling will not reappear after their removal.

Artificial leather is usually undemanding in maintenance. Remove dust regularly with a fine suction force of your vacuum cleaner or with a wet cotton cloth. Dry spilled liquids immediately by a dry cotton or paper towel. Do not let other stains dry on the surface but remove them from the surface immediately with lukewarm water. Wipe the surface carefully with a moistened cotton cloth and dry with a dry towel.

### Natural leather treatment

Remove dust regularly with a fine suction force of your

vacuum cleaner or with a wet cotton cloth. Dry spilled liquids immediately with a dry cotton or paper towel. Do not let other stains dry on the surface but remove them from the surface immediately with lukewarm water. Wipe the surface carefully with a moistened cotton cloth and dry with a dry towel. Once the leather absorbs the liquid, the staining may be irreversible! We recommend that you thoroughly clean and condition your leather furniture with special leather care materials 2-4 times per year depending on the level of use. Always use purpose-made leather care materials. When using any of these cleaners, follow the manufacturer's instructions and test the product first on a less visible area.

! Never use chemical solvents or removers (acetone, benzene, trichloroethylene) or abrasive cleaning paste for fabrics, artificial and natural leathers. Never use polishes or oil- or wax-based products for artificial leather cleaning as they might produce uneven glossy stains on the surface. When cleaning, prevent contact of the detergent with the wooden parts of the product. Do not use hot water or steam cleaners to avoid damage to the upholstery material and do not expose the wooden parts to excessive moisture and heat.

### Other parts

The cane in our products is purely natural. Today, ready-made cane sheets are used instead of hand-weaving. The sheets are made from the inner part of the stem of rattan liana from the forests of Southeast Asia. Before being processed, the cane sheet is moistened to become flexible and then pressed into the groove in the seat or backrest by twisted rattan strings. Drying out then results in the required tensioning of the cane. Rattan fibre as a natural material naturally frays. During processing, the cane surface is smoothened with an electric razor. Cane may crack in a dry and warm environment or by excessive pressure in one place, therefore never kneel or stand on the cane parts of the furniture. To increase the strength and durability of natural cane weave, we recommend application of additional plastic weave (netting). Swivel chairs (types 503, 505, 523) swivel thanks to a simple cast iron mechanism. Swivel is always accompanied by height change, as the swivel mechanism is not connected with mechanical control in these products. Maximum unscrewing and complete disconnection of the parts is prevented by a safety lock (metal stop). Please note that products supplied before the end of 2014 are not yet equipped with the safety lock

and therefore complete unscrewing (i.e. screwing over 68 cm), disconnection and fall may still occur. Please note that swivel chairs (type 503, 523) are designed for home use only; they do not comply with certification for office furniture.

Surfaces made of high-pressure laminate are extremely resistant to scratch, cigarette ash, temperatures up to 180 °C, standard liquids and alcohol. However, careful handling is always recommended.

### Treatment of other parts

Remove dust from the cane parts regularly with a vacuum cleaner with fine suction force or comb the surface carefully with a soft brush. Wipe the cane from time to time with a slightly moistened white cotton cloth or buckskin to prevent excessive drying of the fibre by dry air in the room and let dry naturally. This treatment can be applied even if plastic netting is used under the natural cane weave.

Other parts of the product may be cleaned with standard cleaning detergents designed for the particular material (plastic, metal, glass etc.). When using any of these cleaners, follow the manufacturer's instructions and test the

product first on a less visible area. Severe staining may be removed with lukewarm water. Don't forget to wipe the surface dry with a soft cotton cloth. The cast iron swivel mechanism of chair types 503, 505, 523 does not need special lubrication. However, a one-time application of a very thin layer of silicone oil will do no harm.

To prevent furniture or floor material damage, it is recommended to check the wear of glides every 6 months (particularly the felt and Teflon glides).

Both the wood and the glass components of the Hoop bowl are handmade and require special care. The handcrafted glass bowl is fragile and therefore not recommended for washing in a dishwasher. The same guidance applies to the drinking glass in the Ripple set.

! Never use chemical solvents or removers (acetone, benzene, trichloroethylene) or abrasive cleaning paste for any other material of your product. As for laminated surface, never use polishes or oil- or wax-based products, as they might produce uneven glossy stains on the surface.

### Product assembly and joint check

Follow the Assembly Instructions when assembling the purchased product. Assemble tables on a suitable soft surface. This will prevent mechanical damage to the table top. After completing the assembly, take the table out from the carton wrap and put it on legs. The table should be handled by the number of persons recommended in the Assembly Instructions. Otherwise you

might cause damage to the legs, the table top or the folding mechanism.

Regularly check and tighten all screws and bolts used for connections of the individual parts. This will increase the life and overall strength of the product. Increased clearance of the joints may result in excessive stress on parts and subsequent damage to the product.

! Do not sit or stand on the tables. All folding tables have castors, which allow them to be folded and unfolded easily. Do not use the castors to move the table (whether folded or unfolded). Given the table's weight, they may leave visible marks, particularly on wooden floors, but will not damage them.

### Important information

After the end of the furniture service life treat it as waste, that is hand it over to an authorised waste disposal company for environmental disposal. Please follow all the instructions and recommendations contained herein. Regular professional care will extend the life of your product. In addition, professional care may be required for application of warranty claims. In case of your failure to follow the above-mentioned instructions and recommendations, the manufacturer takes no responsibility for potential damage caused by inappropriate use or handling of the product, such as, for example, standing or kneeling on seating furniture. Our products are intended exclusively for interior use, unless otherwise specified.

TON strives to continuously improve all its products. Therefore please note that changes of the used materials, structure or surface finish may occur at any time. This may also be connected with changes of instructions or recommendations for use of the products. Thank you for your understanding. We wish you pleasant moments with our products.

# index

PRODUCT NUMBER	NAME	Bicolour	Embossed seat/ backrest	Stackability	Page
311 002	002	√			52
313 002	002				52
CB0 002	Carekit Elmo				107
CB0 004	Carebox				107
311 004	4		√		52
313 004	4				52
315 004	4				52
321 004	4		√		52
323 004	4				53
325 004	4				53
311 005	Again			√	67
313 005	Again			√	68
314 005	Again			√	68
311 006	Again				68
313 006	Again				68
314 006	Again				68
311 014	14		√		53
313 014	14				53
315 014	14				53
331 014	Petit				92
711 015	Stand by				104
311 018	18		√		54
313 018	18				54
315 018	18				54
313 020	20				55
315 020	20				55
316 020	20		√		55
317 020	20				55
323 020	20				56
325 020	20				56
326 020	20		√		56
327 020	20				56
711 020	Stand by				104
321 024	24		√		56
323 024	24				56
325 024	24				57
321 025	25				57
323 025	25				57
325 025	25				57
321 030	30				57
323 030	30				57
325 030	30				58
9M5 030	Table top				178
9BJ 030	Table top				178
9UJ 030	Table top				178

PRODUCT NUMBER	NAME	Bicolour	Embossed seat/ backrest	Stackability	Page
9YJ 030	Table top				178
9ZJ 030	Table top				178
9M5 031	Table top				180
9BJ 031	Table top				180
9UJ 031	Table top				180
9YJ 031	Table top				180
9ZJ 031	Table top				180
323 033	33				58
325 033	33				58
326 033	33				58
327 033	33				58
311 035	Ironica				77
313 035	Ironica				77
311 054	Dejavu_054		√		74
313 054	Dejavu_054				74
315 054	Dejavu_054				74
311 056	56				58
313 056	56				59
315 056	56				59
371 060	60		√		59
373 060	60				60
375 060	60				60
371 073	73		√		60
373 073	73				60
375 073	73				60
711 100	Petalo	√			104
711 103	Fleur				104
711 104	Tee				105
712 107	Logs				104
311 115	Ironica				78
313 115	Ironica				78
311 130	56				59
313 130	56				59
315 130	56				59
311 131	Banana				69
313 131	Banana				70
315 131	Banana				70
311 132	18		√		54
313 132	18				55
315 132	18				55
311 134	14		√		53
313 134	14				54
315 134	14				54
4UG 134	Ironica				120
4F1 134	Ironica				120

PRODUCT NUMBER	NAME	Bicolour	Embossed seat/ backrest	Stackability	Page
321 135	135		✓		60
323 135	135				61
325 135	135				61
4UG 135	Ironica				120
4F1 135	Ironica				120
311 149	150		✓		61
313 149	150				61
315 149	150				61
311 150	150		✓		61
313 150	150				62
315 150	150				62
4M5 152	152				116
4M5 252	252				116
309 253	Diner				211
309 254	Gufy				224
309 255	Gufy				224
309 264	Hoop				105
4M5 271	Bloom central	✓			154
4BJ 271	Bloom central	✓			154
4UJ 271	Bloom central	✓			154
4YJ 271	Bloom central	✓			154
4ZJ 271	Bloom central	✓			154
429 271	Bloom central - bases				181
4M5 275	Bloom central	✓			156
4BJ 275	Bloom central	✓			156
4UJ 275	Bloom central	✓			156
4YJ 275	Bloom central	✓			156
4ZJ 275	Bloom central	✓			156
429 275	Bloom central - bases				181
4M5 276	Bloom central	✓			157
4BJ 276	Bloom central	✓			157
4UJ 276	Bloom central	✓			157
4YJ 276	Bloom central	✓			157
4ZJ 276	Bloom central	✓			157
429 276	Bloom central - bases				182
4M5 277	Bloom central	✓			158
4BJ 277	Bloom central	✓			158
4UJ 277	Bloom central	✓			158
4YJ 277	Bloom central	✓			158
4ZJ 277	Bloom central	✓			158
429 277	Bloom central - bases				182
4M5 278	Bloom central	✓			159
4BJ 278	Bloom central	✓			159
4UJ 278	Bloom central	✓			159
4YJ 278	Bloom central	✓			159

PRODUCT NUMBER	NAME	Bicolour	Embossed seat/ backrest	Stackability	Page
4ZJ 278	Bloom central	✓			159
429 278	Bloom central - bases				182
4M5 280	Bloom central	✓			160
4BJ 280	Bloom central	✓			160
4UJ 280	Bloom central	✓			160
4YJ 280	Bloom central	✓			160
4ZJ 280	Bloom central	✓			160
309 279	Merano link				105
309 280	Ripple				105
309 282	Ripple				105
309 284	Ripple				105
311 332	Malmö	✓			85
313 332	Malmö				85
371 368	Rioja				96
371 369	Rioja				96
309 370	Stacking Interlay				106
311 371	Split				97
313 371	Split				97
309 371	Stacking Interlay				106
311 372	Split				97
313 372	Split				98
309 372	Stacking Interlay				106
323 373	Split				98
309 373	Stacking Interlay				106
363 374	Split				98
309 374	Stacking Interlay				107
311 378	Dejavu_378		✓		74
313 378	Dejavu_378				74
315 378	Dejavu_378				75
323 379	Ginger_37				76
311 382	Valencia			✓	101
313 382	Valencia			✓	101
314 382	Valencia			✓	101
311 383	Valencia				102
313 383	Valencia				102
314 383	Valencia				102
311 388	Era_388				75
313 388	Era_388				76
311 391	Prag				93
313 391	Prag				94
311 397	Prag				94
313 397	Prag				94
371 398	Prag				94
373 398	Prag				94
363 392	Dowel				75



PRODUCT NUMBER	NAME	Bicolour	Embossed seat/ backrest	Stackability	Page
363 394	Dowel				75
321 400	Merano				85
323 400	Merano				86
324 400	Merano				86
311 401	Merano			✓	87
313 401	Merano			✓	87
314 401	Merano			✓	88
311 403	Merano				88
313 403	Merano				89
314 403	Merano				89
363 404	Merano				90
799 405	Merano trolley				106
4MJ 406	Lasu			✓	122
4NJ 406	Lasu			✓	122
4ME 409	Lasu				124
4N8 409	Lasu				124
313 414	Albu				68
323 415	Albu				69
363 416	Albu				69
4U0 417	Anix				116
4U0 418	Anix				116
4U0 419	Anix				116
4MJ 421	YYY				131
4MJ 422	YYY				131
4MJ 423	YYY				131
311 437	Leaf				79
313 437	Leaf				80
321 437	Leaf				80
323 437	Leaf				80
371 438	Leaf				81
373 438	Leaf				81
311 439	Leaf				81
313 439	Leaf				82
4MJ 442	Leaf				125
4UJ 442	Leaf				125
4MJ 443	Leaf				126
4UJ 443	Leaf				126
4M5 446	Chop				117
4ME 448	Ink 44				119
799 458	P.O.V.stool trolley				106
371 459	P.O.V.			✓	92
373 459	P.O.V.			✓	93
4M5 460	P.O.V.	✓			134
4BJ 460	P.O.V.	✓			134
4UJ 460	P.O.V.	✓			134

PRODUCT NUMBER	NAME	Bicolour	Embossed seat/ backrest	Stackability	Page
4YJ 460	P.O.V.	✓			134
4ZJ 460	P.O.V.	✓			134
4M5 461	P.O.V.	✓			135
4BJ 461	P.O.V.	✓			135
4UJ 461	P.O.V.	✓			135
4YJ 461	P.O.V.	✓			135
4ZJ 461	P.O.V.	✓			135
4M5 462	P.O.V.	✓			136
4BJ 462	P.O.V.	✓			136
4UJ 462	P.O.V.	✓			136
4YJ 462	P.O.V.	✓			136
4ZJ 462	P.O.V.	✓			136
4M5 463	P.O.V.	✓			138
4BJ 463	P.O.V.	✓			138
4UJ 463	P.O.V.	✓			138
4YJ 463	P.O.V.	✓			138
4ZJ 463	P.O.V.	✓			138
4M5 464	P.O.V.	✓			140
4UJ 464	P.O.V.	✓			140
4YJ 464	P.O.V.	✓			140
4ZJ 464	P.O.V.	✓			140
4M5 465	P.O.V.	✓			141
4UJ 465	P.O.V.	✓			141
4YJ 465	P.O.V.	✓			141
4ZJ 465	P.O.V.	✓			141
4M5 466	P.O.V.	✓			142
4M5 467	P.O.V.	✓			143
4M5 468	P.O.V.	✓			144
4UJ 468	P.O.V.	✓			144
4YJ 468	P.O.V.	✓			144
4ZJ 468	P.O.V.	✓			144
4M5 470	P.O.V.	✓			145
4UJ 470	P.O.V.	✓			145
4YJ 470	P.O.V.	✓			145
4ZJ 470	P.O.V.	✓			145
4M5 473	P.O.V.	✓			147
4BJ 473	P.O.V.	✓			147
4UJ 473	P.O.V.	✓			147
4YJ 473	P.O.V.	✓			147
4ZJ 473	P.O.V.	✓			147
4M5 474	P.O.V.	✓			148
4BJ 474	P.O.V.	✓			148
4UJ 474	P.O.V.	✓			148
4YJ 474	P.O.V.	✓			148
4ZJ 474	P.O.V.	✓			148

PRODUCT NUMBER	NAME	Bicolour	Embossed seat/ backrest	Stackability	Page
4M5 475	P.O.V.	✓			149
4BJ 475	P.O.V.	✓			149
4UJ 475	P.O.V.	✓			149
4YJ 475	P.O.V.	✓			149
4ZJ 475	P.O.V.	✓			149
4M5 476	Jylland				120
311 485	Ideal				77
313 485	Ideal				77
311 488	Ideal				76
313 488	Ideal				77
309 495	P.O.V.				150
351 503	Kontor_503				78
353 503	Kontor_503				79
355 503	Kontor_503				79
371 505	Piano_505		✓		92
373 505	Piano_505				92
375 505	Piano_505				92
313 514	Lyon				82
323 514	Lyon				82
311 515	Lyon				83
313 515	Lyon				83
311 516	Lyon			✓	83
313 516	Lyon			✓	84
321 516	Lyon			✓	84
323 516	Lyon			✓	84
351 523	Kontor_523				79
353 523	Kontor_523				79
355 523	Kontor_523				79
383 530	Diner				197
3S3 530	Diner				196
4UJ 530	Diner				212
383 531	Diner				198
383 532	Diner				198
383 533	Diner				200
3S3 533	Diner				199
383 534	Diner				201
383 535	Diner				201
383 536	Diner				203
3S3 536	Diner				202
383 537	Diner				204
383 538	Diner				204
383 539	Diner				206
3S3 539	Diner				205
383 540	Diner				208
3S3 540	Diner				206

PRODUCT NUMBER	NAME	Bicolour	Embossed seat/ backrest	Stackability	Page
383 541	Diner				210
3S3 541	Diner				209
363 601	Chips				73
373 602	Chips				73
313 623	Moritz				90
323 623	Moritz				91
363 624	Moritz				91
313 625	Moritz				91
4M5 628	Easy Mix & Fix				161
4BJ 628	Easy Mix & Fix				161
4UJ 628	Easy Mix & Fix				161
4YJ 628	Easy Mix & Fix				161
4ZJ 628	Easy Mix & Fix				161
429 628	Easy Mix & Fix - bases				183
4M5 629	Easy Mix & Fix				162
4BJ 629	Easy Mix & Fix				162
4UJ 629	Easy Mix & Fix				162
4YJ 629	Easy Mix & Fix				162
4ZJ 629	Easy Mix & Fix				162
429 629	Easy Mix & Fix - bases				183
4M5 630	Easy Mix & Fix				163
4BJ 630	Easy Mix & Fix				163
4UJ 630	Easy Mix & Fix				163
4YJ 630	Easy Mix & Fix				163
4ZJ 630	Easy Mix & Fix				163
429 630	Easy Mix & Fix - bases				183
4M5 631	Easy Mix & Fix				164
4BJ 631	Easy Mix & Fix				164
4UJ 631	Easy Mix & Fix				164
4YJ 631	Easy Mix & Fix				164
4ZJ 631	Easy Mix & Fix				164
429 631	Easy Mix & Fix - bases				183
4M5 632	Easy Mix & Fix				165
4BJ 632	Easy Mix & Fix				165
4UJ 632	Easy Mix & Fix				165
4YJ 632	Easy Mix & Fix				165
4ZJ 632	Easy Mix & Fix				165
429 632	Easy Mix & Fix - bases				183
4M5 633	Easy Mix & Fix				166
4BJ 633	Easy Mix & Fix				166
4UJ 633	Easy Mix & Fix				166
4YJ 633	Easy Mix & Fix				166
4ZJ 633	Easy Mix & Fix				166
429 633	Easy Mix & Fix - bases				183
4M5 634	Easy Mix & Fix				167

PRODUCT NUMBER	NAME	Bicolour	Embossed seat/ backrest	Stackability	Page
4BJ 634	Easy Mix & Fix				167
4UJ 634	Easy Mix & Fix				167
4YJ 634	Easy Mix & Fix				167
4ZJ 634	Easy Mix & Fix				167
429 634	Easy Mix & Fix - bases				184
4M5 635	Easy Mix & Fix				168
4BJ 635	Easy Mix & Fix				168
4UJ 635	Easy Mix & Fix				168
4YJ 635	Easy Mix & Fix				168
4ZJ 635	Easy Mix & Fix				168
429 635	Easy Mix & Fix - bases				184
4M5 636	Easy Mix & Fix				169
4BJ 636	Easy Mix & Fix				169
4UJ 636	Easy Mix & Fix				169
4YJ 636	Easy Mix & Fix				169
4ZJ 636	Easy Mix & Fix				169
429 636	Easy Mix & Fix - bases				184
4M5 637	Easy Mix & Fix				170
4BJ 637	Easy Mix & Fix				170
4UJ 637	Easy Mix & Fix				170
4YJ 637	Easy Mix & Fix				170
4ZJ 637	Easy Mix & Fix				170
429 637	Easy Mix & Fix - bases				184
4M5 638	Hexagon				171
4BJ 638	Hexagon				171
4UJ 638	Hexagon				171
4YJ 638	Hexagon				171
4ZJ 638	Hexagon				171
429 638	Hexagon - bases				185
4M5 639	Hexagon				172
4BJ 639	Hexagon				172
4UJ 639	Hexagon				172
4YJ 639	Hexagon				172
4ZJ 639	Hexagon				172
429 639	Hexagon - bases				185
4M5 640	Hexagon				173
4BJ 640	Hexagon				173
4UJ 640	Hexagon				173
4YJ 640	Hexagon				173
4ZJ 640	Hexagon				173
429 640	Hexagon - bases				185
4M5 641	Hexagon				175
4BJ 641	Hexagon				175
4UJ 641	Hexagon				175
4YJ 641	Hexagon				175

PRODUCT NUMBER	NAME	Bicolour	Embossed seat/ backrest	Stackability	Page
4ZJ 641	Hexagon				175
429 641	Hexagon - bases				185
363 681	Casablanca				71
4U1 681	Casablanca				116
363 683	Casablanca				71
367 683	Casablanca				72
4U1 683	Casablanca				117
383 684	Casablanca				72
387 684	Casablanca				72
383 685	Casablanca				73
311 690	Punton				94
313 690	Punton				95
371 691	Punton				95
373 691	Punton				95
371 692	Punton				95
373 692	Punton				96
311 700	Stockholm	✓		✓	99
313 700	Stockholm			✓	99
321 700	Stockholm	✓			99
323 700	Stockholm				100
4D6 700	Stockholm	✓			129
4M5 700	Stockholm	✓			129
371 701	Stockholm	✓			100
373 701	Stockholm				100
311 705	Simple 705				96
4ME 706	Malmö	✓			127
4ME 707	Malmö	✓			127
4NJ 708	Trapez				130
311 710	Bergamo			✓	70
313 710	Bergamo			✓	71
321 710	Bergamo			✓	71
323 710	Bergamo			✓	71
313 713	Treviso			✓	100
323 713	Treviso			✓	101
4M5 716	Stelvio				127
4N8 716	Stelvio				128
4ME 717	Stelvio				128
4NC 718	Delta_718				118
4MJ 722	Delta coffee	✓			118
4MJ 723	Delta coffee	✓			118
4MJ 724	Delta coffee	✓			118
4MJ 725	Delta coffee	✓			119
4MJ 726	Delta coffee	✓			119
4MJ 727	Delta coffee	✓			119
311 763	763				62

<b>PRODUCT NUMBER</b>	<b>NAME</b>	<b>Bicolour</b>	<b>Embossed seat/ backrest</b>	<b>Stackability</b>	<b>Page</b>
313 763	763				62
315 763	763				62
311 769	Banana				70
313 769	Banana				70
315 769	Banana				70
313 811	811				62
315 811	811				63
316 811	811				63
317 811	811				63
323 811	811				63
325 811	811				63
326 811	811				63
327 811	811				64
313 813	811				64
315 813	811				64
316 813	811				64
317 813	811				64
363 816	811				64
365 816	811				65
367 816	811				65
363 817	811				65
365 817	811				65
367 817	811				65
311 822	822				65
313 822	822				66
321 822	822				66
323 822	822				66
371 824	822				66
373 824	822				66
371 825	822				66
373 825	822				67
361 826	822				67
363 826	822				67
361 827	822				67
363 827	822				67
383 852	Gufy				214
3S3 852	Gufy				213
383 853	Gufy				214
383 854	Gufy				220
383 855	Gufy				221
3S3 855	Gufy				220
383 856	Gufy				221
383 857	Gufy				224



TON a.s.  
Michaela Thoneta 148  
768 61 Bystřice pod Hostýnem  
Czech Republic  
E-MAIL:  
info@ton.eu  
WEB:  
www.ton.eu

