

Individual Price List **2023**
SEK



SENAB

Färgmarkeringar och/eller symboler för hållbara alternativ i prislistan:

Mörkgrön markering eller symbol

Miljömärkt produkt – Möbler där hela den sammansatta varan har en typ 1 miljömärkning enligt ISO 14024 med Svanen, Möbelfakta, EU Ecolabel eller annan likvärdig märkning.

Ljusgrön markering eller symbol

Hållbarhetsmärkt produkt eller beståndsdel – Möbler där hela eller delar av den sammansatta varan är hållbarhetsmärkt, exempelvis med FSC, EU Ecolabel eller OEKO-TEX®. Leverantören ska kunna ge mer detaljerad information om vilka delar eller variationer som är hållbarhetsmärka vid begäran.

Orange markering eller symbol

Klimatberäknad produkt – Produkt med dokumenterad miljövarudeklaration (EPD) enligt ISO 14025.

Lila markering eller symbol

Produkt med återvunnet eller förnybart material (enligt definitionerna i ISO 14021). Leverantören ska kunna ge information om andel (%) återvunnet och/eller förnybart (biobaserat) vid begäran. Märkning av återvinningsbart material utgår.

Blå markering eller symbol

Demonterbar produkt – Produkt som är demonterbar till olika komponenter och beståndsdelar som i första hand möjliggör återbruk och i andra hand materialåtervinning när produkten nått sin fulla livslängd. Produkten ska vara designad för renovering, det vill säga att det ska vara enkelt att reparera och byta ut moduler, komponenter och beståndsdelar som slits över tid. Exempelvis ska ytskikt, som bordsskivor, textil och stoppning kunna tas isär, avlägsnas och ersättas med hjälp av vanligt förekommande manuella verktyg, ej specialverktyg. Enklare reparationer och utbytesarbeten ska kunna utföras av en lekman. Om det krävs fackmanakunskap för mer avancerade arbeten ska det framgå av anvisningarna som leverantören ska kunna ge vid begäran. Anvisningarna ska innehålla en sprängskiss, steg för steg beskrivning inklusive vilka verktyg som krävs samt hur möbelns ingående delar bör källsorteras.

Whole range

General information

Sales prices for dealers.

Valid from January 1, 2023.

Recommended retail prices.

Without VAT.

You can find the terms and conditions at wilkhahn.com.

Subject to change.

Wilkhahn's quality management system is certified to DIN EN ISO 9001 and its environmental management system to DIN EN ISO 14001 FF.

We reserve the right to make changes to models shown or described. Changes resulting from product improvements or technical advances are not considered justified grounds for complaint.

In addition to standard versions of the table ranges, a variety of customized options are available. Forms, dimensions, surfaces and prices on request.

Additional elements: Left or right always refers to the direction sat in.

Surfaces


Veneered table tops and wood frames on seating are always protected with clear varnish.

Colored metal surfaces are coated with powder varnishes that are free of heavy metals.

Upholstery


All foam used is CFC-free.


Symbols


 Total height

 Total width


 Total depth

 Seating height

 Seat width

 Seat depth

 Veneer direction

 Decor direction

 Sitting direction

The seating height is established under load with DIN testing equipment. The total height, width and depth are the minimum dimensions.

Some of the accessories are shown slightly larger to make them clearer.

Important information / typical product characteristics

Shine

Shine refers to impressions on the cover which can occur due to pressure, body heat and moisture. The form in which it manifests itself depends on the model, materials and upholstery technique and it is one of the characteristics of the design concerned. Therefore it is not a sign of poor quality.

Leather production

Leather is a natural product. Each leather hide is unique. Insect bites, chafed areas or scars are part of the hide's history. They indicate the natural origin and high quality of the material and are therefore not recognized as a justified cause for complaint.

Wood

Wood is a natural product. We only use carefully selected and high-quality wood and genuine wood veneers for our product ranges. Typical characteristics like small knots are signs of natural growth. Because each tree trunk is unique, differences in the structure and color are also possible. The unique surface characteristic of wood is natural and therefore not accepted as justified grounds for a complaint.

Indoor and outdoor furniture

The models are suitable for outdoor use. Nevertheless, we recommend not over-exposing this furniture to the effects of sun, rain, dust and wind and to keep it in a dry and well-aired place when not using.

Differences in color / structure

The combination of different materials, such as chrome plating, or varnishing of aluminum, steel or plastic can lead to differences in the color and structure when the surfaces are compared. These differences do not constitute grounds for complaint.

The RAL/Pantone color info is approximate. Any differences in color do not constitute grounds for complaint.

As regards our upholstery materials and laminates, despite selecting them carefully, there can be slight differences in color which are due to the batch they are produced in. When textiles are made from recycled materials, the colors and textures may be fluctuate more for production reasons. This is a result of our pre-suppliers' manufacturing processes and therefore not recognized as a justified reason for complaint.

Upholstery material

34 / Vivid

Description

80% post-consumer recycled polyester
20% elastomer
320 g/lin. m
width 140 cm

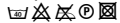
Test results

Abrasion resistance:
100,000 rubs,
BS EN ISO 12947-2 (Martindale)
Lightfastness:
6-8, BS EN ISO 105-B02 method 2
Pilling:
5, BS EN ISO 12945-2

Fastness to rubbing:
Dry 4-5, wet 4-5
EN ISO 105-X12

Flame resistance:
CA TB 117-2013
BS EN 1021-1
BS EN 1021-2
BS 5852 Part 1

Cleaning

Permanent covers:
Vacuum regularly,
have dry cleaned
Replaceable covers:


35 / Fiberflex

Description

100% polyester
510 g/lin. m,
width 160 cm

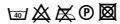
Test results

Abrasion resistance:
70,000 rubs,
BS EN ISO 12947-2 (Martindale)
Lightfastness:
5-7, BS EN ISO 105-B02 method 2

Pilling:
5, BS EN ISO 12945-2
Fastness to rubbing:
Dry 4-5, wet 4-5
EN ISO 105-X12

Flame resistance:
CAL 117 E
EN 1021-1 if mounted on CMHR
foam 35 kg/m³ min.,
EN 1021-2 if mounted on CMHR
foam 50 kg/m³ min.

Cleaning

Vacuum regularly, have dry
cleaned.


37 / Racer

Description

100% polyester
440 g/lin. m,
width 170 cm

Test results

Abrasion resistance:
90,000 rubs,
BS EN ISO 12947-2 (Martindale)
BS EN 14465
Lightfastness:
5-7, BS EN ISO 105-B02 method 2
Pilling:
4-5, BS EN ISO 12945-2

Fastness to rubbing:
Dry 4-5, wet 4-5
EN ISO 105-X12

Flame resistance:

CAL 117 E
BS 476 Part 7, ASTM E 84,
EN ISO 1021 1+2,
EN 1021-1 if mounted on CMHR
foam 35 kg/m³ min.,
EN 1021-2 if mounted on CMHR
foam 50 kg/m³ min.

Cleaning

Vacuum regularly, have dry
cleaned

38 / Era

Description

100% polyester
448 g/lin. m,
width 140 cm

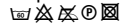
Test results

Abrasion resistance:
100,000 rubs,
BS EN ISO 12947-2 (Martindale)
Lightfastness:
5, BS EN ISO 105-B02 method 2
Pilling:
4-5, BS EN ISO 12945-2

Fastness to rubbing:
Dry 4, wet 4
EN ISO 105-X12

Flame resistance:
EN 1021 1&2 (CMHR)
BS 7176 LH
EN 13501-1 B s1, d0 (adhered)
EN 13501-1 C, s1, d0 (unadhered)

Cleaning

Permanent covers:
Vacuum regularly,
have dry cleaned
Replaceable covers:


41 / Formstrick

Description

100% polyamide hybrid
750 g/m²

Test results

Abrasion resistance:
200,000 rubs,
BS EN ISO 12947-2 (Martindale)
Lightfastness:
6, BS EN ISO 105-B02 method 2

Pilling:
5, BS EN ISO 12945-2
Fastness to rubbing:
Dry 5, wet 5
EN ISO 105-X12

Flame resistance:
DIN EN 1021 1+2

Cleaning

Vacuum regularly, have dry
cleaned.
If it's very damp, the elasticity of
the Formstrick can slightly slack-
en, but will regain its original
shape when it dries.

47 / Nova

Description

100% polyester
560 g/lin. m,
width 140 cm

Test results

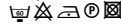
Abrasion resistance:
50,000 rubs,
BS EN ISO 12947-2 (Martindale)

Lightfastness:

5-7, BS EN ISO 105-B02 method 2
Pilling:
5, BS EN ISO 12945-2
Fastness to rubbing:
Dry 4-5, wet 4-5
EN ISO 105-X12

Flame resistance:
CAL 117 E,
EN 1021-1 if mounted on PUR foam
22 kg/m³ min.,
EN 1021-2 if mounted on CMHR
foam, 36 kg/m³ min.

Cleaning

Permanent covers:
Vacuum regularly, have dry
cleaned
Replaceable covers:


51 / Oceanic

Description

100% recycled, post-consumer
polyester with 50% SEAQUAL
yarn.

497 g/m²
width 140 cm


Test results

Abrasion resistance:
100,000 rubs,
BS EN ISO 12947-2 (Martindale)
Lightfastness:
5, BS EN ISO 105-B02

Fastness to rubbing:
Dry 4, wet 4
EN ISO 105-X12

Flame resistance:
EN 1021 1&2 (CMHR)
BS 7176 LH (CMHR)
BS 7176 MH (CMHR+treatment)

Cleaning

Vacuum regularly, have dry
cleaned


54 / Pitch

Description

100% Trevira CS
470 g/lin. m,
width 140 cm

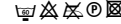
Test results

Abrasion resistance:
100,000 rubs,
BS EN ISO 12947-2 (Martindale)
Lightfastness:
5-7, BS EN ISO 105-B02 method 2
Pilling:
4-5, BS EN ISO 12945-2

Fastness to rubbing:
Dry 4-5, wet 4-5
EN ISO 105-X12

Flame resistance:
CAL 117 E,
DIN 4102-1 B1,
NF P 92-503-507 M1,
ÖNORM A 3800-1,
B1/Q1/TR1,
BS 5852 if mounted on CMHR
foam,
EN 1021-1/-2 if mounted on PUR
foam min. 30 kg/m³,
UNI VF 9175 1IM if mounted on
CMHR foam.

Cleaning

Permanent covers:
Vacuum regularly, have dry
cleaned
Replaceable covers:


58 / Evida

Description

More than 80% of the compo-
nents used are made of natural
and renewable materials (approx.
50% renewable, approx. 30% nat-
ural and approx. 20% other mate-
rials).

Weight: 750 +/- 50 g/m²
thickness: 1.3 +/- 0.2 mm
width 137 cm

Test results

Abrasion resistance:
> 50,000 rubs,
DIN EN ISO 54702 (Martindale)
Flame resistance:
flame retardant,
EN10211+ 2,
BS 5852 ISO+ 1

Complies with the OekoTex®
Standard 100,
complies with the German Medi-
cal Product Act
DIN EN ISO 109935+ 10,
durable,
complies with the toy safety
standard, DIN EN 713,
can withstand disinfectants

Cleaning

Please remove any soiling imme-
diately (use a warm, mild soapy
water, a microfiber cloth and soft
brush). Please don't use solvents.

60 / Blend

Description

100% virgin wool
645 g/lin. m,
width 140 cm

Test results

Abrasion resistance:
50,000 rubs,
BS EN ISO 12947-2 (Martindale)

Lightfastness:
5, BS EN ISO 105-B02

Pilling:
3-4, BS EN ISO 12945-2

Fastness to rubbing:
Dry 4, wet 4
EN ISO 105-X12

Flame resistance:
EN 1021-1,
EN 1021-2
BS 7176 Low Hazard
NF D 60-013

ÖNORM B 3825 & A 3800-1 (58kg/
m³ CMHR Foam)
UNI 9175 Class 1 IM
BS 476 Part 7 Class 1
EN 13501-1 Adhered Class D, s1,
d0

Please state when ordering:
BS 5852 Ignition Source 5 if treat-
ed with flame retardants;
BS 7176 Medium Hazard if treated
with flame retardants;

BS 476 Part 6 Class 0 if treated with flame retardants;
EN 13501-1 Adhered Class B, s1, d0 wenn mit FR ausgerüstet;
EN 13501-1 Unadhered Class D, s2, d0 if treated with flame retardants;
BS 5867-2: Type B Curtains & Drapes if treated with flame retardants
Cleaning
Permanent covers:
Vacuum regularly, have dry cleaned
Replaceable covers:

64 / Morph Description

85% New Zealand wool
15% polyamide
475 g/lin. m,
width 140 cm
Test results
Abrasion resistance:
200,000 rubs,
BS EN ISO 12947-2 (Martindale)
Lightfastness:
5-6, BS EN ISO 105-B02
Pilling:
4, BS EN ISO 12945-2
Fastness to rubbing:
Dry 4-5, wet 4-5
EN ISO 105-X12
Flame resistance:
EN 1021 1&2
BS 5852 Part 1
BS 5852 Crib 5 (CMHR)
CA TB 117-2013
Flame retardancy depends on the foam used.

Cleaning
Vacuum regularly, have dry cleaned
☒ ☒ ☒ ☒ ☒ ☒

65 / Re-wool Description

5% recycled wool, 45% virgin wool, worsted, 10% nylon
540 g/lin. m,
width 140 cm
Test results
Abrasion resistance:
approx. 100,000 rubs,
BS EN ISO 12947 (Martindale)
Lightfastness:
5-7, BS EN ISO 105-B02
Fastness to rubbing:
Dry 5-7, wet 4-5
EN ISO 105-X12
Flame resistance:
EN 1021 1&2
BS 5852 Part 1
BS 5852 ignition source 3 (CMHR)
BS 5852 Crib 5 (CMHR+treatment)
NF D 60-013 (CMHR)
UNI 9175 Class 1 | M (CMHR)
ÖNORM A 3800-1 B1, Q1
CA TB 117-2013
Cleaning
Vacuum regularly, have dry cleaned
☒ ☒ ☒ ☒ ☒ ☒

66 / Lona Description

85% virgin wool, 15% polyamide
520 lin. m
width 140 cm
Test results
Abrasion resistance:
150,000 rubs,
BS EN ISO 12947-2 (Martindale)
Lightfastness:
5-7, BS EN ISO 105-B02 method 2
Pilling:
4, BS EN ISO 12945-2
Fastness to rubbing:
Dry 4-5, wet 4-5
EN ISO 105-X12
Flame resistance:
CAL 117 E,
ÖNORM A 3800-1 Q1,
ÖNORM B 3852 flame retardant if mounted on PUR foam B2,
BS 7176 medium hazard if mounted on CMHR foam 35kg/m³ min.,
EN 1021-1/-2 if mounted on PUR foam, 22 kg/m³ min.
Cleaning
Permanent covers:
Vacuum regularly, have dry cleaned.
Because of pilling, the Lona fabric might require more cleaning.
Replaceable covers:
☒ ☒ ☒ ☒ ☒ ☒

68 / Kvadrat Remix Description

90% virgin wool, worsted 10% nylon,
415 g/lin. m,
width approx. 138 cm
Test results
Abrasion resistance:
approx. 100,000 rubs,
BS EN ISO 12947-2 (Martindale)
Lightfastness:
5-7, BS EN ISO 105-B02 method 2
Pilling:
4, BS EN ISO 12945-2
Fastness to rubbing:
Dry 4-5, wet 4
EN ISO 105-X12
Flame resistance:
B2 and Crib 5 with flame retardant finish,
IMO FTP Code 2010:Part 8,
US Cal. Bull. 117-2013 AS/NZS 1530.3: AS/NZS 3837 Class 2,
NF D 60 013. UNI 9175 1IM,
ÖNORM B1/ Q1,
EN 1021-1/2 ignition source 0-1.
BS 5852 part 1.
Cleaning
Cleaning permanent covers:
Vacuum regularly, have dry cleaned.
Replaceable covers:
☒ ☒ ☒ ☒ ☒ ☒

600 / Hush Stripe 40 Description

80% polyester, 20% viscose
290 g/lin. m
width 170 cm

Test results

Lightfastness:
5-7, BS EN ISO 105-B02
Fastness to rubbing:
Dry 4-5, wet 4-5
EN ISO 105-X12
Flame resistance:
BS 476 Part 7, class
ASTM E 84 class 1+2
Cleaning
Vacuum regularly

91 / Kvadrat Steelcut Trio Description

90% virgin wool,
worsted 10% nylon,
770 g/lin. m,
width approx. 140 cm
Test results
Abrasion resistance:
approx. 100,000 rubs,
BS EN ISO 12947-2 (Martindale)
Lightfastness:
5-7, BS EN ISO 105-B02 method 2
Pilling:
4, BS EN ISO 12945-2
Fastness to rubbing:
Dry 4-5, wet 3-5
EN ISO 105-X12
Flame resistance:
when ordering, please state
EN 1021-1/2
BS 5852 part 1 DIN 4102 B2
Önorm B1/Q1
NF D 60 013
UNI 9175 1IM
US Cal. Bull. 117, – 2013
NFPA 260 AS/NZS 3837
IMO FTP Code 2010:
Part 8
B2 and Crib 5 and SN
198 898 5.3 for flame retardant finishes.
Cleaning
Permanent covers:
vacuum regularly, have dry cleaned.
Replaceable covers:
☒ ☒ ☒ ☒ ☒ ☒

92 / Credo Description

95% virgin wool
5% polyamide
870 g/lin. m
width 140 cm
Test results
Abrasion resistance:
100,000 rubs,
BS EN ISO 12947-2 (Martindale)
Lightfastness:
min. 5-8, BS EN ISO 105-B02 method 2
Pilling:
min. 4-5, BS EN ISO 12945-2
Fastness to rubbing:
dry 5, wet 4-5
EN ISO 105-X12
Flame resistance:
please state when ordering,
FAR 25.853 (12 seconds vertical)
CAL TB 117-2013
DIN 4102-1 B2
EN 13501-1

EN 1021-1 and -2
BS 5852:1979 (part 1)
BS 5852:2006 (part 2) Crib5
BKZ: 5.3 SN 198898
UNI 9175 (1 IM)
NF P92 503-507 M2
IMO: 2014/90/EU marine equipment directive
Cleaning

Permanent covers:
Vacuum regularly, have dry cleaned
Replaceable covers:
☒ ☒ ☒

74 / Leather Description

Cowhide for furniture with tolerances in terms of color and texture, compliant with DGM, RAL GZ 430.

Test results

Lightfastness:
6-7, BS EN ISO 105-B02 method 2
Flame resistance:
California TB 117 E BS 5852-3 when mounted on PUR foam 22 kg/m³ min.,
EN 1021-1/-2 when mounted on PUR foam 22 kg/m³ min.

Cleaning

Remove any soiling with a damp, absorbent cloth and rub over the whole area with a dry woolen cloth immediately.

87 / Leather Description

Particularly high-quality, pure aniline-dyed cowhide leather, which reveals natural irregularities or subsequent shine.

Test results

Lightfastness:
(WBS level) >3 compliant with DIN EN ISO 105-B02
Flame resistance:
DIN 75200 and DIN EN 1021 part 1+2,
CE 117 E

Cleaning

Carefully remove any soiling with a slightly damp, absorbent cloth and immediately rub all over with a dry woolen cloth.

Information

Wilkhahn provides no guarantee for fabrics and leathers submitted that come from fabric manufacturers whom it has no supplier agreement with. Please note that we require a cover material sample of at least DIN A4 in size to check whether we can use it.

Price List 2023



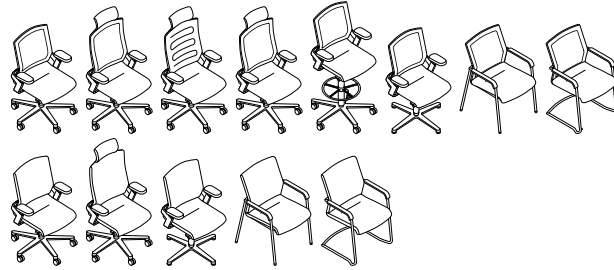
Content according to ranges

Quickship



16

170 Range – ON



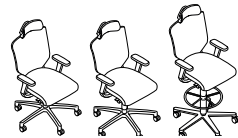
20

180 Range – Neos



32

184 Range – IN



36

186 Range – Metrik



42

187 Range – AT



44

20 Range – Stitz 2



54

202 Range – Stand-up



56

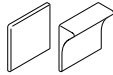


204 Range – Sitzbock



58

208 Range – Landing



60

21 Range – FS-Line



62

21 Range – FS Management



66

222 Range – Occo



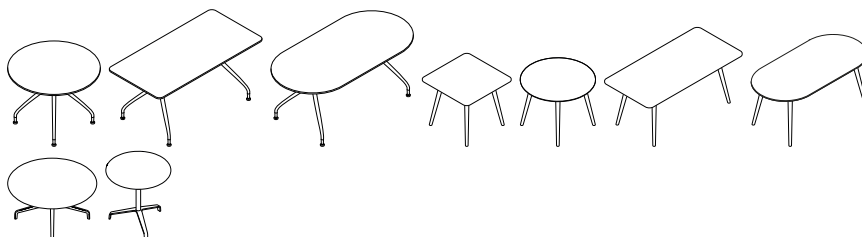
68

224/225 Range – Occo Conference / Occo Lounge



88

222 Range – Occo



68

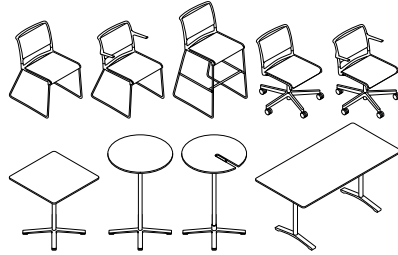


227 Range – Pep



102

230 Range – 230 range



108

238 Range – Aula



112

26 Range – Modus Basic



124

27 Range – Modus Compact



126

28 Range – Modus Medium



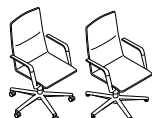
132

28 Range – Modus Executive



136

290 Range – Sola



140



295 Range – Intra



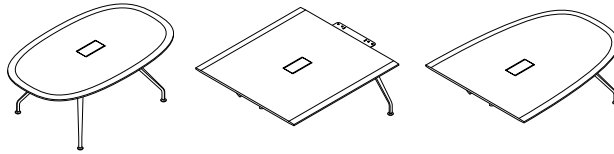
142

30 Range – Graph



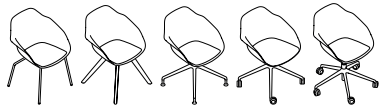
144

300 Range – Graph tables



150

320 Range – Yonda



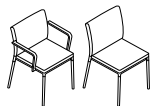
162

322 Range – Yonda Lounge



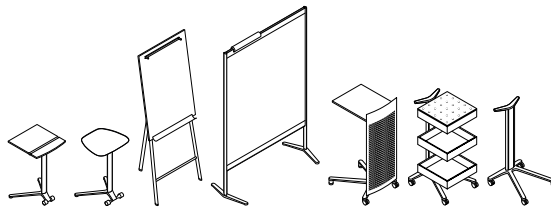
168

361 Range – Ceno



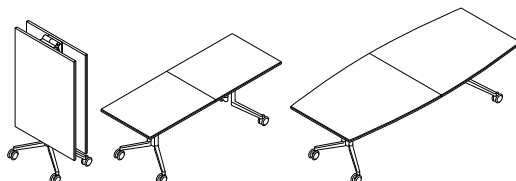
174

440 Range – Confair



178

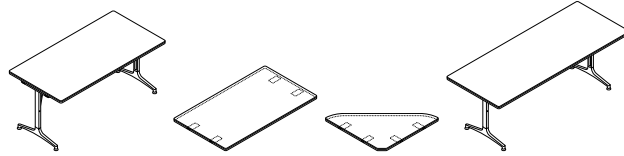
440 Range – Confair folding table



184

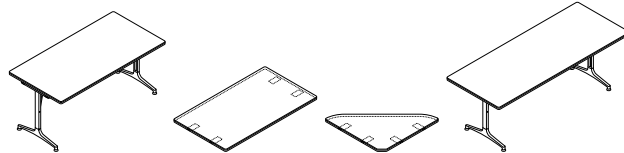


460 Range – mAx



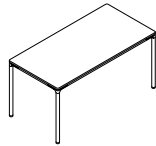
196

465 Range – mAx light



202

540 Range – Contas



216

610 Range – Timetable



220

612 Range – Timetable Smart



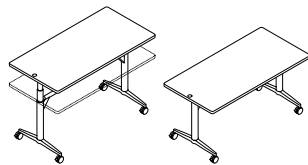
222

614 Range – Timetable Shift



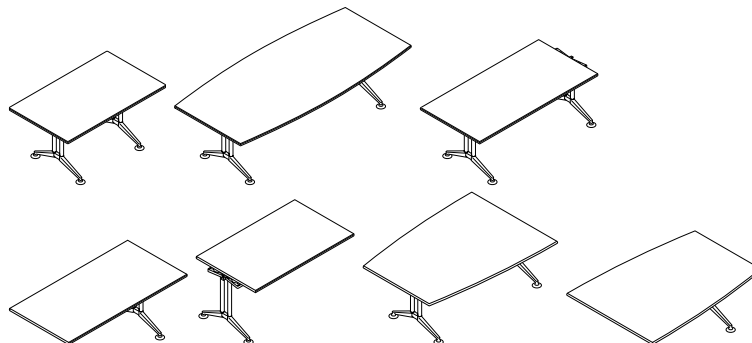
224

615 Range – Timetable Lift



238

620 Range – Logon

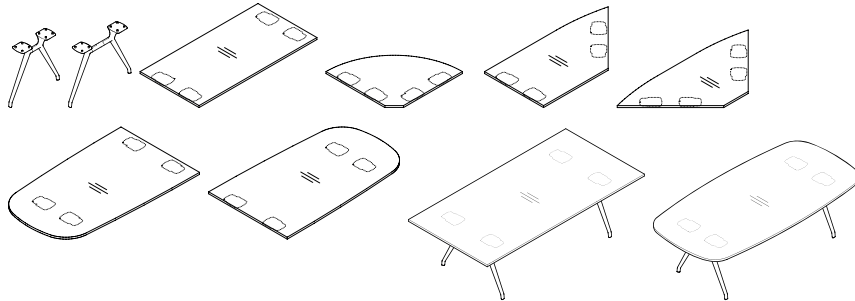


244



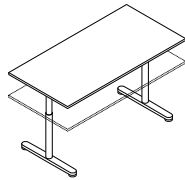
636 Range – Versa

260



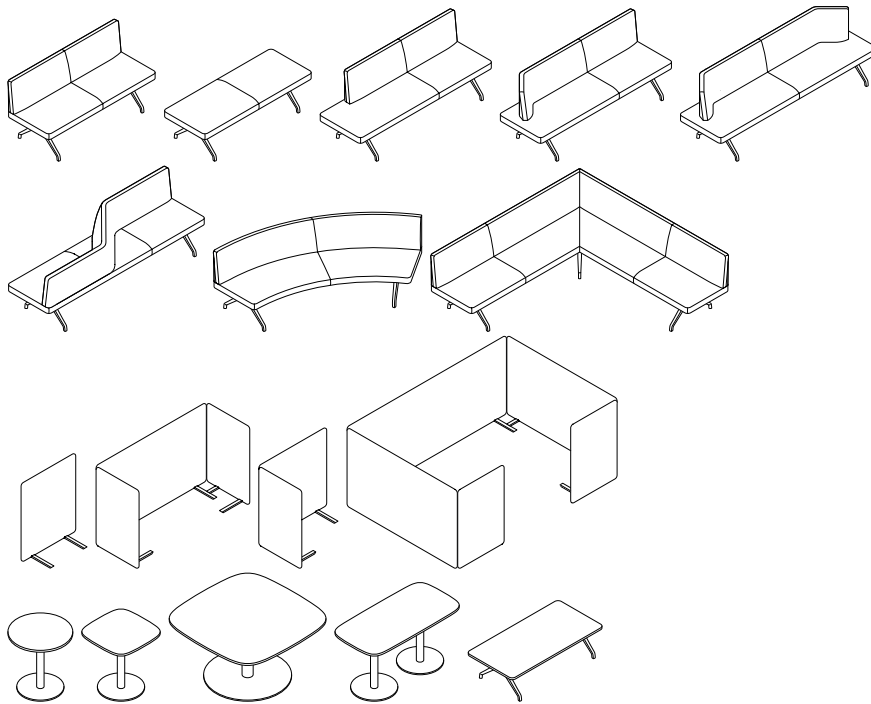
661 Range – Height-adjustable Travis

286



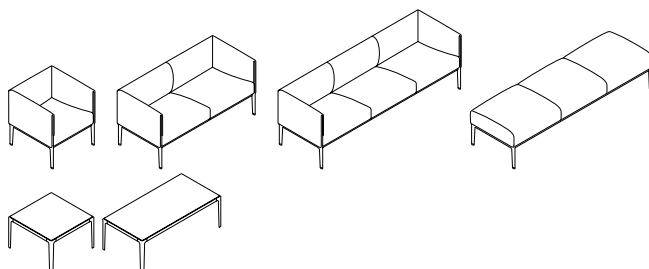
780 Range – Insit

288



860 Range – Asienta

304





Built-in component set range

308

Edging matrix

320



Content in alphabetical order

230 range	230 Range	108
Asienta	860 Range	304
AT	187 Range	44
Aula	238 Range	112
Ceno	361 Range	174
Confair	440 Range	184
Confair folding table	440 Range	184
Contas	540 Range	216
FS Management	21 Range	66
FS-Line	21 Range	66
Graph	30 Range	144
Graph tables	300 Range	150
IN	184 Range	36
Insit	780 Range	288
Intra	295 Range	142
Landing	208 Range	60
Logon	620 Range	244
mAx	460 Range	196
mAx light	465 Range	202
Metrik	186 Range	42
Modus Basic	26 Range	124
Modus Executive	28 Range	136
Modus Medium	28 Range	136
Modus Compact	27 Range	126
Neos	180 Range	32
Occo	222 Range	68
Occo Conference / Occo Lounge	224/225 Range	88
Occo	222 Range	68
ON	170 Range	20
Pep	227 Range	102
Quickship		16
Sitzbock	204 Range	58
Sola	290 Range	140
Stand-up	202 Range	56
Stitz 2	20 Range	54
Timetable	610 Range	220
Timetable Lift	615 Range	238
Timetable Shift	614 Range	224
Timetable Smart	612 Range	222
Versa	636 Range	260
Yonda	320 Range	162
Yonda Lounge	322 Range	168



Wilkhahn and sustainability

In over 100 years of its corporate history, Wilkhahn can look back on a sustainability philosophy that has grown over decades. Aspects such as durability, social fairness, environmental responsibility and cultural orientation have been evolving as corporate principles since the 1950s. Wilkhahn today is regarded internationally as a model of excellence, not only on account of its products but also because of its modern corporate philosophy. This is because the company realized early on that sustainable design should embrace environmental aspects, improve social relationships and define the cultural role of a company. This approach to the way we do business creates a bond between us and our customers throughout the world. There is surely no more rewarding task than working together for a successful future that is worth living in.

Corporate principles

We believe in the power of good design.

Which is why we're passionate about sustainable office furnishings worldwide that boost health, foster well-being and creativity and empower people to do their jobs well.

Good communication is the key to encouraging creativity and productivity.

We develop, produce and market pioneering, superbly designed, high-quality office chairs and tables.

Form and function on an equal footing.

The Wilkhahn brand stands for first-class product quality, highly innovative ergonomics, and pioneering design.

We set ground-breaking trends.

Which is why innovations at Wilkhahn start by thinking outside the box. A product development isn't about a new chair per se, but better dynamic sitting, not about a new table, but nurturing communication, not about a new sofa, but coming together with other people and relaxing.

We pass knowledge on.

Because knowledge is the future's most important commodity. As a company, our competitive edge is underpinned by our workforce's expertise. Which is why we see learning as a personal develop-

ment opportunity. And we share that expertise in the company and with business partners to build on our joint success.

We provide products and service in impressive quality.

The whole is more than the sum of its parts – but it's the quality of all the details that governs the quality of the finished product or service. Which is why providing excellence that covers the whole spectrum of issuing quotes, producing and shipping our products is one of the core brand values and is evident in every product and process and every encounter with the brand.

We understand the changes in workplaces and offer our customers solution-driven support.

Wilkhahn customers buy the added value and benefits associated with our products and services. To spot new trends and requirements, we keep our finger on the pulse. We examine our customers' needs in detail to provide impressive solutions.

Simply the best.

We take responsibility and help shape the future.

We operate a policy of fairness towards each other and our suppliers, customers, and the environment. The combination of business success, socio-ecological responsibility and involvement in cultural activities makes us an exemplary company worldwide that we continue to develop sensitively.

Sustainability policy

UN Global Compact
Wilkhahn joined the United Nations Global Compact initiative in 2007. The company commits itself to the ten principles of Global Compact regarding the protection of international human rights, adherence to labor standards and rights for employees,

the protection of the environment and anti-corruption, all of which are specified as binding corporate policy.



WE SUPPORT

ISO 9001:2015 quality management system

In order to safeguard and continually optimize the high quality of products and processes at Wilkhahn, a comprehensive quality management system was set up as early as 1996. Since then it has been certified for compliance with the ISO 9001 Quality Management Standard of the International Standardization Organization. Quality management is all about customer focus, management responsibility, the participation of all employees involved, ensuring and improving process safety and supplier relations.



ISO 14001:2015 environmental management system

Wilkhahn is also certified to the ISO 14001 international environmental management standard, which defines globally recognized requirements for environmental management systems, such as environmental performance indicators and environmental performance assessments.

EMAS

EMAS is the acronym for EcoManagement and Audit Scheme, developed by the European Union. As a combined environmental management and auditing system, its purpose is to verify companies are improving their environmental performance. At the north German headquarters in Bad Münden, Wilkhahn has been regularly certified based on the latest version of EMAS since 2001. In the environmental statement, confirmed by annual audits, Wilkhahn gives a public account of the company's environmental performance. The printed version of the environmental statement can

be ordered at www.wilkhahn.com/service. Detailed ecological product information on each of the products is also available to download.



FSC

The Forest Stewardship Council® (FSC) quality label indicates compliance with stringent socio-ecological requirements in terms of forest management and trading wood products. Wilkhahn's Bad Münden headquarters meet the criteria of the Forest Stewardship Council (FSC) and are entitled to process and sell FSC®-certified products (license code C118389, certificate no. TUEV-COC-000462).



Das Zeichen für verantwortungsvolle Waldwirtschaft

Product certification

Wilkhahn office furniture ranges are not only certified according to international testing and inspection standards regarding product safety and functional integrity. They also meet all key international reference systems for highly health-compatible and environmentally friendly products.

GREENGUARD™

Virtually all Wilkhahn ranges undergo GREENGUARD testing and certification. The Greenguard Environmental Institute is an independent institution in the US that primarily certifies products with regard to their suitability for interiors. Besides environmental



aspects, special focus is placed on ensuring that products do not emit any pollutants that might be harmful to health.



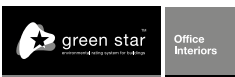
LEED

Leadership in Energy and Environmental Design (LEED) is a rating system used by the US Green Building Council to evaluate the environmental and social compatibility of buildings. LEED certification awards extra credit points if Wilkhahn office chair and table ranges are used.



Green Star

Green Star is an extensive, voluntary rating system developed by the Australian Green Building Council. The system assesses how ecological a building's design is. The system uses various categories to rate any potential ecological impact resulting from a location chosen for a project, the way the project is carried out, managed or its design.



FISP

The UK Furniture Industry Sustainability Program (or FISP for short) wants to foster effective environmental protection, social progress, careful usage of natural resources, economic growth and employment. FISP was developed by the British Furniture Industry Environment Committee (FIEC) whose members include key trade associations and furniture manu-

facturers. Since 2006, FISP has developed into an international network of over 60 members, one of whom is Wilkhahn.



Responsibility from the very start

In the design and development process, ecological impact is also taken into consideration in addition to design, functional and business-related aspects. Because these factors play a pivotal role in the materials chosen, manufacturing processes, options regarding assembly, logistics and transport and how easy products are to repair or recycle. This overview shows the key aspects for the entire product life cycle that currently apply at Wilkhahn.

Materials

The materials used are subject to stringent controls. Prohibited chemicals are not used in our products at all. All feedstock is listed in a register of hazardous substances. This helps to minimise the use of or substitute any potentially harmful materials. With the goal being to achieve maximum durability and quality, some recycled materials are used in the production of Wilkhahn ranges. This applies in particular to metals like steel and aluminum.

Production

Water conservation, waste management and sustainable energy production

Water is becoming an increasingly important resource. Wilkhahn spares no effort in minimizing water consumption in all areas. By treating process water, recycling and using state-of-the-art varnishing machinery, no waste water is produced that requires monitoring. The Wilkhahn waste management concept includes sorting waste selectively, as well as recycling and disposing of all waste fractions resulting from the production and management departments. The continual decrease of energy consumption is an important goal of the environmental management system. A combined heat and power plant and connection to a biogas plant at the Bad Münden site have more than dou-

bled energy efficiency. As a result, heating at the headquarters and production facilities is CO₂ neutral.

Wilkhahn production sites

Wilkhahn products are produced or assembled at the Bad Münden (Germany) and Sydney (Australia) sites. The branch facilities and the international subsidiaries are not only subject to quality management requirements, but also to guidelines for the socio-ecological focus of corporate policy which apply through the entire company.

Product utility

Aesthetics and design

Sustainable products must be practical. The Wilkhahn ranges are timeless, with useful, intuitive-to-use functions and come in durable materials. A standard that is reflected in every single detail. The Wilkhahn design approach therefore results in an increase in the utility value of a product that is destined to last.

Durability and guarantee

The ranges set standards for product design that is sustainable in the best possible sense of the word. The durability of the high-quality materials, the innovative functionality and the traditional, understated design guarantee our furniture will last for decades. We give a five-year manufacturers' guarantee, allowing customers to plan reliably (refer to the relevant guarantee policy for details). An issue we feel responsible for, regardless of our products' long useful lives. We consider guarantees way beyond these periods as selling the future short. Our services to extend the ecological life of the furniture include maintenance as well as an overhaul of older ranges. Wilkhahn guarantees it will carry out repairs on discontinued furniture for at least two years after production has ceased.

End of the product life cycle

Product take-back and recycling

Even after the product has reached the end of its life, we still feel responsible and offer our customers extensive take-back and recycling services. We guarantee to take back all products that are no longer in use. Wilkhahn products are dismantled in the factory, all parts are selectively sorted in terms of their inherent materials and then recycled. By labeling the materials, ensuring

they're non-toxic and easy to dismantle, we're already making sure today that the components in Wilkhahn products can be incorporated into local material and production cycles and be properly recycled and disposed of.

Disassembly and recycling

Most of Wilkhahn's product components are suitable for non-destructive disassembly. To ensure that materials can be sorted according to type, all components weighing more than 150 g come with a label that is valid across the world. No agents to protect materials or organic halogen compounds are used which would prevent subsequent recycling.



Quickship

Sometimes short lead times are sometimes very important to the customer. Which is why Wilkhahn created an express delivery pro-

gramme called Quickship so that it can deliver chairs within eight working days and tables with ten working days after receipt of

order to its customers. The Quickship models are pre-produced and therefore only available in the

designs and quantity specified. The Quickship option offers chair models of up to 20 max and table models of up to 5 max.

ON® task chair

■ 97/109 ■ 69 ■ 66
■ 40/52 ■ 50 ■ 43



55174/7

with seat cushioning, with 3D armrests, backrest covered in Fiberflex fabric, upholstery material 35/99 Fiberflex, precision-adjustable height, adjustable backrest height (up to 60 mm), Trimension, tension control plastic star base, black coated aluminum swivel arms

SEK

10437

ON® task chair

■ 97/109 ■ 69 ■ 66
■ 40/52 ■ 50 ■ 43



55174/8

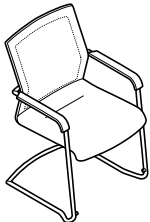
similar to 174/7, with seat-depth extension (approx. 400 to 450 mm) seat cushioning, with 3D armrests, backrest covered with Fiberflex fabric, upholstery material 35/99 Fiberflex, precision-adjustable height, adjustable backrest height (to 60 mm, Trimension, tension control Plastic star base, aluminum swivel arms coated black

SEK

11487

ON® cantilever chair

■ 92 ■ 61 ■ 60
■ 43



55178/7

with seat cushioning, up to 5 stackable free-standing, backrest covered with Fiberflex fabric, upholstery material 35/99 Fiberflex, polypropylene armrests bright chrome-plated frame

SEK

6489



Neos task chair

■ 92/104 ■ 66 ■ 64
■ 40/52 ■ 46 ■ 43



55181/71

with 3D armrests,
adjustable backrest height and seat-depth extension,
precision-adjustable height,
synchro-adjustment, tension control,
lockable backrest,
plastic frame,
hard or soft casters,
fabric 47/10

SEK

7812

IN task chair

■ 101/113 ■ 69 ■ 66
■ 40/52 ■ 46 ■ 43



55184/7

with seat cushioning,
upholstery material Racer 37/99 black,
with 1D armrests, PP armrest pads
back covered with single-ply Formstrick 41/99 black,
precision-adjustable height,
height-adjustable lumbar support,
Trimension, tension control,
optionally with a 3D forward tilt of 5° (please state when ordering),
black plastic star base, black matte-coated swivel arms

SEK

8421

IN task chair

■ 101/113 ■ 69 ■ 66
■ 40/52 ■ 46 ■ 43



55184/8

similar to 184/7, with seat-depth extension (approx. 400 to 450 mm)
with seat cushioning,
upholstery material Racer 37/99 black,
with 3D armrests, PP armrest pads,
backrest covered with single ply Formstrick 41/99 black,
precision-adjustable height,
height-adjustable lumbar support,
Trimension, tension control,
optionally with a 3D forward tilt of 5° (please state when ordering),
black plastic star base, black, matte black coated swivel arms

SEK

9870



AT task chair

98/110 H 67 H 64
40/52 H 50 H 43



55187/7

with seat and backrest upholstery,
Racer 37/99 black upholstery material,
seat and backrest shell, synchro-adjustment mechanism in black
height-adjustable lumbar support
with 1D armrests and PP armrest pads
precision-adjustable height
3D kinematics with automatic weight adjustment
optionally with customized presetting
Trimension
plastic star base

SEK

7098

like 187/7, with seat-depth extension (approx. 390 bis 450 mm)
with seat and backrest upholstery
upholstery material Racer 37/99 black,
seat and backrest shell, synchro-adjustment mechanism in black
height-adjustable lumbar support
with 3D armrests, armrest pads made of PP,
precision-adjustable height
3D kinematics with automatic weight adjustment
optionally with customized presetting
Trimension
plastic star base

8138

AT Mesh task chair

101/113 H 67 H 64
40/52 H 50 H 43



55187/71

with with seat cushioning,
Racer 37/99 black upholstery material, mesh-covered, black metal backrest
seat shell, backrest frame and synchro-adjustment mechanism in black,
height-adjustable lumbar support,
with 1D armrests, armrest pads made of PP
precision-adjustable height,
3D kinematics with automatic weight adjustment
optionally with customized presetting
Trimension
Plastic star base

SEK

7224

with seat cushioning
Racer 37/99 black upholstery material, mesh-covered black metal backrest,
seat shell, backrest frame and synchro-adjustment mechanism in black
with seat-depth extension (approx. 390 bis 450 mm)
height-adjustable lumbar support
with 3D armrests, armrest pads made of PP
precision-adjustable height
3D kinematics with automatic weight adjustment
optionally with customized presetting
Trimension
plastic star base

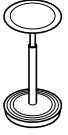
8264

Quickship

Lead time for up to 20 within 8 working days ex works



Stitz
E63/88 H31



55201/2

Embossed leather 74/99 seat,
black frame

SEK

7413

Stand-up
E67 H32



202/0101

covered in Fiberflex fabric 35/99: black
incl. carry-strap
black base

SEK

3497

Stand-up
E67 H32



202/0102

covered in Fiberflex fabric 35/89: red
incl. carry-strap
black base

SEK

3497

170 Range ON®

Design: wiege



Technical details

Function

Task chairs with Trimension®, synchronous, three-dimensional kinematics to encourage three-dimensional dynamic sitting. The perfect interaction of the synchro-adjustment mechanism, seat and backrest automatically adapts to any posture the user adopts. The supporting counter pressure is quickly and precisely adjustable in any direction (4.5 rotations max.) for people weighing from 45 to 120 kg. The backrest height is adjustable by up to 60 mm in six lockable positions. The backrest and seat can be locked in the front sitting position. The seating height is precision adjustable between 400 mm and 520 mm at the touch of a button with a DIN 4550-compliant gas lift. All models are optionally available with seat-depth extension of 400 to 450 mm. (The height of the counter chairs is precision adjustable between 680 mm and 810 mm). Meeting/visitor chairs with Trimension, on request, available with swivel-mounted column, not height adjustable, alternatively as a four-leg variant or cantilever chair, optionally stackable.

Frame

Task chairs and counter stool

Five-star base, optionally made of black through-dyed plastic or die-cast aluminum, coated (black, black with a textured matte finish, or in a silver satin finish), polished or bright chrome-plated. Twin-wheel swivel casters with load-dependent braking, made of black polyamide compliant with DIN EN 12529 as the standard version for carpets; with gray soft polyurethane tire for hard floors. The casters are optionally electrically conductive. Swivel arms made of die-cast aluminum, coated (black or black with a textured matte finish or silver satin finish), polished or bright chrome-plated. Mechanism shell made of die-cast, shot-blasted aluminum, optionally coated in black or with a silver satin finish, with top cover made of black, through-dyed polypropylene. The gas lift is covered by a telescopic protective tube made of black, through-dyed polypropylene.

Counter stool with extra height-adjustable foot ring, bright chrome-plated, with lock screw to affix it and twin-wheel swivel casters with load-dependent braking.

24-hour chairs

All have a die-cast aluminum star base with extra swivel arm supports, with a modified synchro-adjustment mechanism and exceptionally hard-wearing covers from Wilkhahn's fabric and leather collection. Designed for people weighing up to 120 kg, the models consequently comply with the DIN EN 1335 standard requirements for 24-hour use.

Visitor/conference chairs

Four-star base made of die-cast aluminum, coated (black, black with a textured matte finish or silver satin finish), polished or bright chrome-plated. Black, multipurpose glides made of plastic for all types of flooring. Swivel arms made of die-cast aluminum, coated (black or black with a textured matte finish or silver satin finish), polished or bright chrome-plated. Mechanism shell made of die-cast, shot-blasted aluminum, optionally coated in black or with a silver satin finish, with top cover made of black, through-dyed polypropylene. The gas lift is covered by a telescopic protective tube made of black, through-dyed polypropylene.

Cantilever chair

Frame made of bright chrome-plated tubular steel, 22 mm in diameter, with anti-tilt stopper made of black polyamide as the standard version for carpets, with extra glides for hard flooring, with felt inserts on request.

Four-leg visitor chair

Frame made of bright chrome-plated tubular steel, legs 22 mm in diameter. Models 176/7 and 176/71 with multipurpose, POM (polyoxymethylene) glides in black for soft and hard floorings.

Seat

Task, visitor, and conference chairs

Highly elastic, flexibly suspended seat shell with seat upholstery panel made of black, through-dyed polypropylene, polyurethane seat cushioning covered in the same material as the backrest cover in Fiberflex, or fabric. The seat is replaceable. All models optionally have seats with soft padding (with extra cut foam and facings at the sides). In models with management grade upholstery (174/71, 175/71, 171/71), seat cushioning also with extra padding and side facings, optionally covered in leather too. Optionally with seat-depth extension from 400 to 450 mm (all types with upholstery). Model 175/73 with soft padding, as well as color-contrasting double seams and contour stitching. Seat cushioning with side facings. Task chair models 174/7, 174/72, 175/7, 175/72, 174/71, 175/71 optionally with a constant 6-degree tilt.

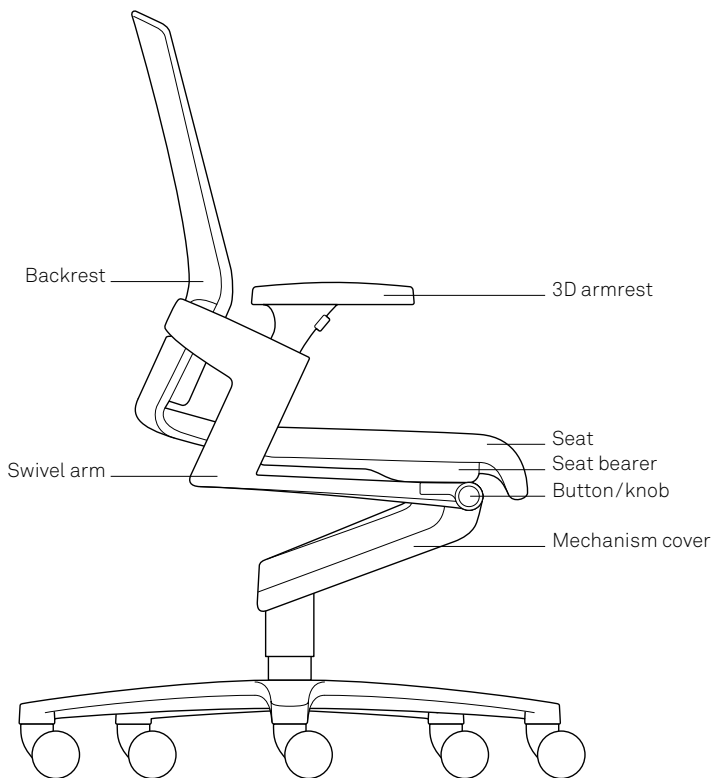
Backrest

Task, visitor, and conference chairs

Elastic backrest frame, height adjustable by 60 mm in six lockable positions, made of through-dyed, fiberglass-reinforced polyamide, covered with Fiberflex, optionally also with fabric (and extra padding).

All models optionally with soft padding (with extra cushion thickness). For models with management grade upholstery, the backrest frame also optionally comes with back cushioning and the front of the backrest also with concealed, cut foam fleece sewn into the cover and with side facings, optionally with a leather cover.

All models optionally with soft padding (with extra cut foam). Medium-high and high backrest, high backrest optionally with headrest (height 16 cm), either in the same material as the backrest cover, or covered in leather on the front. The backrest is replaceable. Model 175/73 with soft padding, as well as color-contrasting double seams and contour-defining stitching.





Seat and backrest

Cantilever chair/four-leg visitor chair

Unitary, shell frame made of through-dyed, fiberglass-reinforced polypropylene. Seat cushioning made of polyurethane one-piece molded foam, in models with management grade upholstery (models 176/71, 178/71) with additional padding and side facings. All models optionally with soft padding (with extra cut foam). In models 176/7, 178/7 seat cushioning covered in the same material as the backrest cover in Fiberflex or fabric, in models 176/71 and 178/71 with management grade upholstery optionally also in leather. The seat is replaceable. The backrest frame is covered in Fiberflex, in models 176/7, 178/7 optionally with back covered in fabric (with additional padding). In models with management grade upholstery optionally with backrest upholstery in fabric or leather, with additional padding, as well as on the front of backrest also with concealed, cut foam fleece sewn into the cover and side facings, backrest cover can be replaced.

Armrests

Task chairs

3D armrests made of fiberglass-reinforced, black through-dyed polyamide. Armrest pads made of black, through-dyed polyurethane (TPU), optionally also made of polyurethane foam and covered in leather if desired. Upholstered, leather-covered armrests (optional) in model 175/73 with color-contrasting stitching. Armrest covers made of black, through-dyed polypropylene. Height of armrests adjustable by 100 mm (eight lockable positions), depth by 40 mm, can be swivelled 30° inwards and outwards in each case.

Conference/visitor chairs

Fixed armrests made of fiberglass-reinforced, black, through-dyed polyamide. Armrest pads made of black, through-dyed polyurethane (TPU), optionally also made of polyurethane foam and covered in leather if desired. Armrest covers made of black, through-dyed polypropylene.

Cantilever/four-leg visitor chair

Armrest pads made of black, through-dyed polypropylene. With chairs that are not stackable, optionally with upholstered armrests, when covered in fabric with black leather 74/99, when covered in leather to match the color of the leather.

Standards

The ON task chairs and visitor/meeting chairs comply with the type A or B DIN EN 1335 office-chair, ANSI/BIFMA X5.1 and IGR standards. If required, NPR 1813 models are available.

The ON cantilever chairs and four-leg visitor chairs comply with the DIN EN 16139-L1 and ANSI/BIFMA X5 standards.



All visitor and conference chairs have glides for soft flooring (e.g. carpets). On request, available with swivel-mounted column, not height adjustable, (at no additional charge).

Please note:

The prices for types with cushioning that includes fabrics and leather provided by the customer are given on request. Four-leg chairs: to the DIN EN 16139-L1 office-chair standard, up to 5 chairs can be stacked vertically. Cantilever chair: to the DIN EN 16139-L1 office-chair standard, up to 3 chairs can be stacked vertically.

Accessories

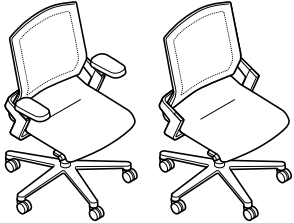
Optionally for visitor chair model 176/7: Inline connector model 177 made of zinc-plated steel. Optionally for cantilever chair, model 178/7, four-wheeled trolley, model 178 for 8 cantilever chairs. Optionally, the ON task, visitor and conference chairs (without headrest) can also be shipped with dismantled backrests in boxes.

Task chairs	Star base	Swivel arms	Mechanism shell
	50 Plastic	Silver satin finish, coated black or black with textured matte finish	Shot-blasted aluminum
	51 Bright chrome-plated	Silver satin finish, coated black or black with textured matte finish or with bright chrome plating	Shot-blasted aluminum
	52 Polished aluminum	Polished aluminum	Shot-blasted aluminum
	53 Coated black (RAL 9011)	Coated black or black with textured matte finish	Shot-blasted aluminum
	60 Coated with a silver satin finish (RAL 9006)		Shot-blasted aluminum
	90 Coated with a black textured matte finish (RAL 9011)		Shot-blasted aluminum
Visitor chairs	Round steel tubing frame		
	51 Bright chrome-plated		
Cantilever chair	Round steel tubing frame		
	51 Bright chrome-plated		
Small components	Casters, glides, frame components, adjustment levers		
	41 Black		



Medium-height backrest

97/109 H 69 H 66
40/52 H 50 H 43



174/7

with seat cushioning,
optionally with soft padding (please state in
order),
with 3D armrests,
backrest covered with Fiberflex fabric,
precision-adjustable height,
adjustable backrest height (to 60 mm),
Trimension tension control
Plastic star base, aluminum-coated swivel arms

Additional charge/reduced prices

Covered backrest (not in the case of artificial
leather 58)
Backrest with soft padding
Permanent comfort tilt (6°)

Coated aluminum star base
Polished aluminum star base
Aluminum bright chrome-plated star base
Polished aluminum swivel arms
Aluminum bright chrome-plated swivel arms

Seat-depth extension, approx. 40 to 45 cm
Polyurethane foam armrest pad
Upholstered, leather-covered armrests
Mechanism shell coated in black or with a silver
satin finish.
Electrically conductive casters

Without armrests

	35	47	51 54 58	60 64 65 66 68	91 92
	SEK	SEK	SEK	SEK	SEK
174/7	10437	11183	11351	11519	11771
Covered backrest (not in the case of artificial leather 58)		1082	1334	1502	1764
Backrest with soft padding	1019	1229	1460	1628	1943
Permanent comfort tilt (6°)	609	609	609	609	609
Coated aluminum star base	1103	1103	1103	1103	1103
Polished aluminum star base	1586	1586	1586	1586	1586
Aluminum bright chrome-plated star base	2205	2205	2205	2205	2205
Polished aluminum swivel arms	494	494	494	494	494
Aluminum bright chrome-plated swivel arms	2468	2468	2468	2468	2468
Seat-depth extension, approx. 40 to 45 cm	1050	1050	1050	1050	1050
Polyurethane foam armrest pad	683	683	683	683	683
Upholstered, leather-covered armrests	2447	2447	2447	2447	2447
Mechanism shell coated in black or with a silver satin finish.	494	494	494	494	494
Electrically conductive casters	515	515	515	515	515
Without armrests	-829	-829	-829	-829	-829

All task chairs are fitted with casters for soft flooring (e.g. carpets). Please order with soft casters (at no extra charge) for hard flooring (e.g. stone, parquet). Electrically conductive casters (only if an aluminum frame is chosen) available for an extra charge.



High backrest

□ 105/117 □ H70 □ H66
□ 40/52 □ H50 □ H43



175/7

with seat cushioning,
optionally with soft padding (please state in
order),
with 3D armrests,
backrest covered with Fiberflex fabric,
precision-adjustable height,
adjustable backrest height (to 60 mm),
Trimension tension control
Plastic star base, aluminum-coated swivel arms

Additional charge/reduced prices

Covered backrest (not in the case of artificial
leather 58)

Backrest with soft padding

Headrest in same material as backrest cover

Headrest covered in leather on the front, 74/99,
black

Permanent comfort tilt (6°)

Coated aluminum star base

Polished aluminum star base

Aluminum bright chrome-plated star base

Polished aluminum swivel arms

Aluminum bright chrome-plated swivel arms

Seat-depth extension, approx. 40 to 45 cm

Polyurethane foam armrest pad

Upholstered, leather-covered armrests

Mechanism shell coated in black or with a silver
satin finish.

Electrically conductive casters

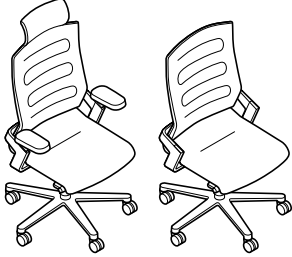
Without armrests

	35	47	51 54 58	60 64 65 66 68	91 92
	SEK	SEK	SEK	SEK	SEK
	13125	13871	14039	14207	14459
		1271	1544	1880	2321
	1218	1355	1691	2027	2583
	945	945	945	945	945
	1544	1544	1544	1544	1544
	609	609	609	609	609
	1103	1103	1103	1103	1103
	1586	1586	1586	1586	1586
	2205	2205	2205	2205	2205
	494	494	494	494	494
	2468	2468	2468	2468	2468
	1050	1050	1050	1050	1050
	683	683	683	683	683
	2447	2447	2447	2447	2447
	494	494	494	494	494
	515	515	515	515	515
	-829	-829	-829	-829	-829



**High backrest
with contoured upholstery**

■ 105/117 ■ 70 ■ 66
■ 40/52 ■ 50 ■ 43



175/73

with seat cushioning in soft padding,
with 3D armrests,
backrest covered, with contoured upholstery,
precision-adjustable height,
adjustable backrest height (up to 60 mm),
Trimension, tension control
Plastic star base, aluminum-coated swivel arms

Additional charge/reduced prices

Headrest in same material as backrest cover
Headrest covered in leather on the front, 74/99,
black
Permanent comfort tilt (6°)

Coated aluminum star base
Polished aluminum star base
Aluminum bright chrome-plated star base
Polished aluminum swivel arms
Aluminum bright chrome-plated swivel arms

Seat-depth extension, approx. 40 to 45 cm
Polyurethane foam armrest pad
Upholstered, leather-covered armrests
Mechanism shell coated in black or with a silver
satin finish.
Electrically conductive casters

Without armrests

60*

SEK

17640

945

1544

609

1103

1586

2205

494

2468

1050

683

2447

494

515

-829



24-hour chair

105/117 H 69 H 66
40/52 H 50 H 43



175/8

with seat cushioning,
optionally with soft padding (please state in
order),
with 3D armrests,
covered backrest,
precision-adjustable height,
adjustable backrest height (to 60 mm),
Trimension tension control
Aluminum coated star base and swivel arms

Additional charge/reduced prices

Backrest with soft padding
Headrest in same material as backrest cover
Headrest covered in leather on the front, 74/99,
black
Permanent comfort tilt (6°)

Polished aluminum star base
Aluminum bright chrome-plated star base
Polished aluminum swivel arms
Aluminum bright chrome-plated swivel arms

Seat-depth extension, approx. 40 to 45 cm
Polyurethane foam armrest pad
Upholstered, leather-covered armrests
Electrically conductive casters

Without armrests

54 66 91
68 92

SEK SEK SEK

20160 20654 22743

1691 2027 2583

945 945 945

1544 1544 1544

609 609 609

483 483 483

1103 1103 1103

494 494 494

2468 2468 2468

1050 1050 1050

683 683 683

2447 2447 2447

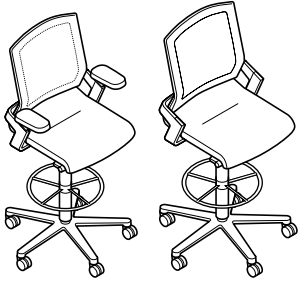
515 515 515

-829 -829 -829



Counter stool

□125/138 □69 □66
□68/81 □50 □43



174/1

with seat cushioning,
optionally with soft padding (please state in
order),
with 3D armrests,
backrest covered with Fiberflex fabric,
precision adjustable height,
adjustable backrest height (to 60 mm),
Trimension tension control,
with bright chrome-plated foot ring (with
precision-adjustable height)
Aluminum coated star base and swivel arms

Additional charge/reduced prices

Covered backrest (not in the case of artificial
leather 58)
Backrest with soft padding

Polished aluminum star base
Aluminum bright chrome-plated star base
Polished aluminum swivel arms
Aluminum bright chrome-plated swivel arms

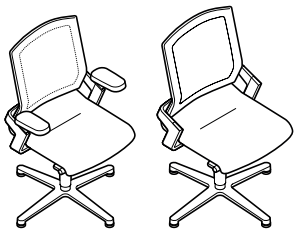
Seat-depth extension, approx. 40 to 45 cm
Polyurethane foam armrest pad
Upholstered, leather-covered armrests
Mechanism shell coated in black or with a silver
satin finish.

Without armrests

	35	47	51 54 58	60 64 65 66 68	91 92
	SEK	SEK	SEK	SEK	SEK
	14207	14952	15120	15288	15540
		1082	1334	1502	1764
	1019	1229	1460	1628	1943
	483	483	483	483	483
	1103	1103	1103	1103	1103
	494	494	494	494	494
	2468	2468	2468	2468	2468
	1050	1050	1050	1050	1050
	683	683	683	683	683
	2447	2447	2447	2447	2447
	494	494	494	494	494
	-829	-829	-829	-829	-829

Medium-height backrest

□97/109 □69 □66
□40/52 □50 □43



171/7

with seat cushioning,
fixed armrests,
backrest covered with Fiberflex fabric
precision-adjustable height,
adjustable backrest height (to 60 mm),
Trimension tension control
Aluminum coated star base and swivel arms

Additional charge/reduced prices

Covered backrest (not in the case of artificial
leather 58)

Polished aluminum star base
Aluminum bright chrome-plated star base
Polished aluminum swivel arms
Aluminum bright chrome-plated swivel arms

Polyurethane foam armrest pad
Upholstered, leather-covered armrests
Mechanism shell coated in black or with a silver
satin finish.

Without armrests

	35	47	51 54 58	60 64 65 66 68	91 92
	SEK	SEK	SEK	SEK	SEK
	11750	12495	12663	12831	13083
		1082	1334	1502	1764
	483	483	483	483	483
	1103	1103	1103	1103	1103
	494	494	494	494	494
	2468	2468	2468	2468	2468
	683	683	683	683	683
	2447	2447	2447	2447	2447
	494	494	494	494	494
	-829	-829	-829	-829	-829

All counter chairs come with multipurpose casters.
On request, all conference and visitor chairs are available with swivel-mounted column, not height adjustable, (at no extra charge).



Standard height backrest H 90 H 64 H 64 H 43	176/7	with seat cushioning, optionally with soft padding (please state in order), up to 5 can be stacked free-standing, backrest covered with Fiberflex fabric, polypropylene armrests Bright chrome-plated frame	SEK	SEK	SEK	SEK	SEK	SEK	SEK	SEK	SEK
			6258	7014	7193	7361	7623				
		Additional charge/reduced prices									
		Covered backrest (not in the case of artificial leather 58)	1019	1082	1334	1502	1764				
		Backrest with soft padding		1229	1460	1628	1943				
		Upholstered, leather-covered armrests (not stackable)	2447	2447	2447	2447	2447				

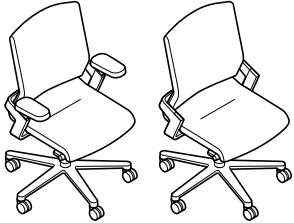
Standard height backrest H 92 H 61 H 60 H 43	178/7	with seat cushioning, optionally with soft padding (please state in order), up to 5 can be stacked free-standing, backrest covered with Fiberflex fabric, polypropylene armrests Bright chrome-plated frame	SEK	SEK	SEK	SEK	SEK	SEK	SEK	SEK	SEK
			6489	7214	7382	7539	7791				
		Additional charge/reduced prices									
		Covered backrest (not in the case of artificial leather 58)	1019	1082	1334	1502	1764				
		Backrest with soft padding		1229	1460	1628	1943				
		Upholstered, leather-covered armrests (not stackable)	2447	2447	2447	2447	2447				

All visitor and conference chairs have glides for soft flooring (e. g. carpets). Four-leg chair with casters for soft flooring (e. g. carpets). Please order with soft casters (at no extra charge) for hard flooring (e. g. stone, parquet)
All cantilever chairs are fitted with anti-tilt stoppers as the standard design for soft flooring (e. g. carpets). For hard floorings (e. g. stone) please order with soft glides, for wooden floorings (e. g. parquet) please order with extra felt glides (at no extra charge in each case).



Medium-height backrest

97/109 H 69 H 66
40/52 H 50 H 43



174/71

Seat with management grade upholstery optionally with soft padding (please state in order), with 3D armrests, backrest covered with Fiberflex fabric, precision adjustable height, adjustable backrest height (to 60 mm), Trimension tension control
Plastic star base, aluminum-coated swivel arms

Additional charge/reduced prices

Backrest with management grade upholstery
Permanent comfort tilt (6°)

Coated aluminum star base
Polished aluminum star base
Aluminum bright chrome-plated star base
Polished aluminum swivel arms
Aluminum bright chrome-plated swivel arms

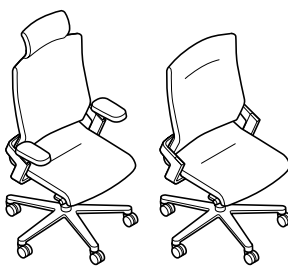
Seat-depth extension (approx. 400 to 450 mm)
Polyurethane foam armrest pad
Upholstered, leather-covered armrests
Mechanism shell coated in black or with a silver satin finish.
Electrically conductive casters

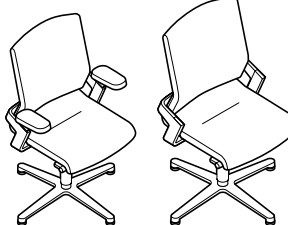
Without armrests

	51	60 64 65 66 68	91 92	74	87
	SEK	SEK	SEK	SEK	SEK
	11697	11876	12275	13619	16065
	3308	3654	4263	5051	6615
	462	462	462	462	462
	1103	1103	1103	1103	1103
	1586	1586	1586	1586	1586
	2205	2205	2205	2205	2205
	494	494	494	494	494
	2468	2468	2468	2468	2468
	1050	1050	1050	1050	1050
	683	683	683	683	683
	2447	2447	2447	2447	2783
	494	494	494	494	494
	515	515	515	515	515
	-829	-829	-829	-829	-829

All task chairs are fitted with casters for soft flooring (e.g. carpets). Please order with soft casters (at no extra charge) for hard flooring (e.g. stone, parquet). Electrically conductive casters (only if an aluminum frame is chosen) available for an extra charge.

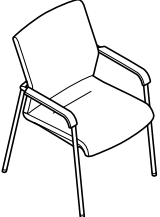


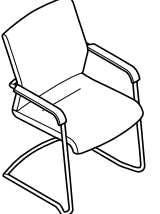
				60 64 65 66 68	91 92	74	87	
				51				
				SEK	SEK	SEK	SEK	
High backrest □105/117 □70 □66 □40/52 □50 □43 	175/71	Seat with management grade upholstery optionally with soft padding (please state in order), with 3D armrests, backrest covered with Fiberflex fabric, precision adjustable height, adjustable backrest height (to 60 mm), Trimension tension control Plastic star base, aluminum-coated swivel arms		14144	14322	14721	17630	18512
	Additional charge/reduced prices							
		Backrest with management grade upholstery		3581	3948	4610	5376	6972
		Headrest in same material as backrest cover		945	945	945	1544	1607
		Headrest covered in leather on the front, 74/99, black		1544	1544	1544	1544	1544
		Permanent comfort tilt (6°)		462	462	462	462	462
		Coated aluminum star base		1103	1103	1103	1103	1103
		Polished aluminum star base		1586	1586	1586	1586	1586
		Aluminum bright chrome-plated star base		2205	2205	2205	2205	2205
		Polished aluminum swivel arms		494	494	494	494	494
		Aluminum bright chrome-plated swivel arms		2468	2468	2468	2468	2468
		Seat-depth extension (approx. 400 to 450 mm)		1050	1050	1050	1050	1050
		Polyurethane foam armrest pad		683	683	683	683	683
	Upholstered, leather-covered armrests		2447	2447	2447	2447	2783	
	Silver or black coated mechanism shell		494	494	494	494	494	
	Electrically conductive casters		515	515	515	515	515	
	Without armrests		-829	-829	-829	-829	-829	

				60 64 65 66 68	91 92	74	87	
				51				
				SEK	SEK	SEK	SEK	
Medium-height backrest □97/109 □69 □66 □40/52 □50 □43 	171/71	Seat with management grade upholstery optionally with soft padding (please state in order), rigid 3D armrests, backrest covered with Fiberflex fabric, precision adjustable height, adjustable backrest height (to 60 mm), Trimension tension control Aluminum coated star base and swivel arms		12558	12737	13136	16044	16926
	Additional charge/reduced prices							
		Backrest with management grade upholstery		3308	3654	4263	5051	6615
		Polished aluminum star base		483	483	483	483	483
		Aluminum bright chrome-plated star base		1103	1103	1103	1103	1103
		Polished aluminum swivel arms		494	494	494	494	494
		Aluminum bright chrome-plated swivel arms		2468	2468	2468	2468	2468
		Polyurethane foam armrest pad		683	683	683	683	683
		Upholstered, leather-covered armrests		2447	2447	2447	2447	2783
		Mechanism shell coated in black or with a silver satin finish.		494	494	494	494	494
		Without armrests		-829	-829	-829	-829	-829

All task chairs are fitted with casters for soft flooring (e.g. carpets). Please order with soft casters (at no extra charge) for hard flooring (e.g. stone, parquet).
 Electrically conductive casters (only if an aluminum frame is chosen) available for an extra charge.
 All visitor and conference chairs can be supplied with a swivel-mounted column which is not height-adjustable (at no extra charge).



			60	64	65	66	68	91	92	74	87
			51								
			SEK	SEK	SEK	SEK	SEK	SEK	SEK	SEK	SEK
Standard height backrest H90 H64 H64 H43 	176/71 Seat with management grade upholstery optionally with soft padding (please state in order), backrest covered with Fiberflex fabric, polypropylene armrests Bright chrome-plated frame Additional charge/reduced prices Backrest with management grade upholstery Upholstered, leather-covered armrests		8337	8526	8988	11886	12789				
			3308 2447	3549 2447	4263 2447	5051 2447	6615 2783				

			60	64	65	66	68	91	92	74	87
			51								
			SEK	SEK	SEK	SEK	SEK	SEK	SEK	SEK	SEK
Standard height backrest H92 H61 H60 H43 	178/71 Seat with management grade upholstery optionally with soft padding (please state in order), backrest covered with Fiberflex fabric, polypropylene armrests Bright chrome-plated frame Additional charge/reduced prices Backrest with management grade upholstery Upholstered, leather-covered armrests		8358	8537	8978	11739	12600				
			3308 2447	3549 2447	4263 2447	5051 2447	6615 2783				



Inline connector

177
(for model 176/7)

SEK

473

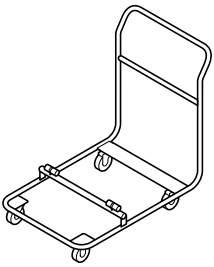


Four-wheeled trolley

178
for 8 cantilever chairs

SEK

8862



180 Range Neos

Design: wiege



Technical details

Function

Task chairs with automatic synchro-adjustment: The tilt of the seat and backrest automatically adapt to any postures users adopt. When leaning back, the backrest tension increases proportionately. The person using the chair can adjust the tension precisely by turning a crank. The backrest is lockable in four position at the touch of a button. In task chairs a DIN 4550-compliant gas lift for precision adjustment of the seating height. Adjustment of backrest height in seven positions within a range of 60 mm; models with mesh membrane backrests have lumbar support adjustable within a range of 60 mm instead of the adjustable backrest height. All models with seat-depth extension in 11 positions ranging from 385 – 435 mm. Models with a mesh membrane backrest as for task chair versions.

Cantilever chairs: stackable up to 5-high, for visitors, meetings, conferences and seminars to match the office task chairs; with flexible, unitary seat shell, integral stacking buffer and outer rail on the backrest. Models 183/3 with leather covers (74) and 183/5 are not stackable.

Frame

Task chairs

Five-star base in fiberglass-reinforced polyamide, through-dyed in black-gray, or in die-cast aluminum, polished, high-luster polished or bright chrome-plated. Twin-wheel swivel casters with load-dependent braking DIN-EN-12529-compliant as the standard version for carpeting; with gray polyurethane tire for hard flooring (please specify when ordering). Anti-static casters on request (when an aluminum frame is chosen). Mechanism shell in die-cast aluminum. Mechanism cover in black-gray through-dyed polypropylene. Seat bearer in fiberglass-reinforced polyamide, through-dyed in black-gray. See table below for frame types.

Counter stool

Star base from the ON 170 range, with additional height-adjustable, bright chrome-plated foot ring, with lock screw to affix it and twin-wheel swivel casters with load-dependent braking.

Cantilever chair

Frame in round steel tubing, 22 mm in diameter, thickness 3 mm, bright chrome-plated, with anti-tilt stoppers in black-gray polyamide as the standard version for carpeted floors, optionally with glides in black-gray polyamide (for soft floors) or black-gray polyurethane (for hard floors), optionally with additional felt insert (please specify when ordering); outer rail in die-cast zinc, bright chrome plated. Optional outer rail made of very strong, fiberglass-reinforced plastic, color-matched with the shell.

Seat

Task chairs

Seat shell in polypropylene, through-dyed in black-gray or white. Cushioning: covered, one-piece molded polyurethane foam with integral pelvic support, exchangeable. Seat depth can be custom-extended from 385 mm to 435 mm. The seat is designed in such a way that the angle of the pelvic support automatically adjusts to the position of the seat shell.

Backrest

Task chairs

Backrest shell made of polyamide with backrest shell cover made of polypropylene, black-gray or white through-dyed. Cushioning: covered polyurethane one-piece molded foam, replaceable. Model 181/6 with backrest frame in fiberglass-reinforced polyamide, black-gray, covered with transparent, black gray, light gray or white high-performance polyester fabric, lower back frame cover in polypropylene, black-gray, optional lumbar support in polyamide, through-dyed in black-gray, with integral foam on top.

Seat and backrest

Cantilever chair

Unitary seat- and backrest shell made of elastic polypropylene, through-dyed black-gray or white. Seat cushion: exchangeable, with concealed screw fittings; comprising seat upholstery panel and covered polyurethane one-piece molded foam. Type with optional, replaceable back cushioning the same as the seat cushion. Model 183/3 with leather cover not stackable. Model 183/5 (not stackable) With leather-covered seat and back cushions with wool-fleece overlay and side facings, optionally with seat and back shell covered with leather on seat and backrest shell.

Armrests

Task chairs

3D armrests in fiberglass-reinforced polyamide, through-dyed in black-gray or white, with black-gray polyurethane pad, adjustable by 100 mm in height and 50 mm in depth; can be swiveled inwards and outwards by 15°.

Cantilever chair

PVC-free, sleeve-shaped armrest pad made of black-gray or white thermoplastic elastomer. In model 183/5, armrest pad, upholstered or covered in leather with top stitching, or optionally with solid wood pads, oak, maple or walnut with a natural finish.

Standards

The Neos task chairs and visitor/meeting chairs comply with the type A or B DIN EN 1335 office-chair, ANSI/BIFMA X5.1 and IGR standards. If required, NPR 1813 models are available.

The cantilever chairs comply with DIN EN 16139-L1 and ANSI/BIFMA X5.1 standards.



Neos task chairs comply with the Ergonomics Approved label.



Please note:

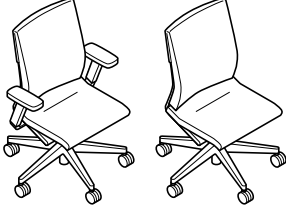

The prices for types with cushioning that includes fabrics and leather provided by the customer are given on request. Cantilever chair: to the DIN EN 16139-L1 office-chair standard, up to 5 chairs can be stacked vertically.

Task chairs

Star base

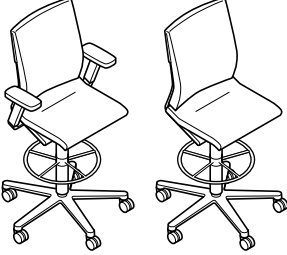
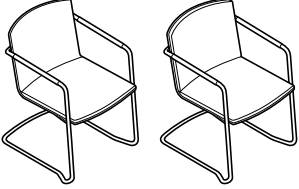
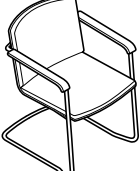
- 50 Plastic
- 51 Bright chrome-plated
- 52 Polished aluminum
- 72 High-luster polished aluminum



		38	47	51 54 58	60 64 65 66 68	91 92	74
<p>Medium-height backrest □98/110 □66 □64 □40/52 □46 □43</p> 	181/71 with seat and backrest upholstery with 3D armrests precision-adjustable height adjustable backrest height and seat-depth extension automatic synchro-adjustment, tension control Plastic frame	SEK	SEK	SEK	SEK	SEK	SEK
		7466	7812	8096	8715	9671	13115
	Additional charge/reduced prices Seat and backrest shell and 3D armrests white through-dyed (armrest pad always black-gray)	1523	1523	1523	1523	1523	1523
	Polished aluminum frame	977	977	977	977	977	977
	High-luster polished aluminum frame	1292	1292	1292	1292	1292	1292
	Bright chrome-plated aluminum frame	2027	2027	2027	2027	2027	2027
	Electrically conductive casters	515	515	515	515	515	515
	Without armrests	-871	-871	-871	-871	-871	-871
		38	47	51 54 58	60 64 65 66 68	91 92	74
	<p>Medium-height backrest □98/110 □66 □64 □40/52 □46 □43</p> 	181/6 with seat cushioning and transparent backrest, with 3D armrests precision-adjustable height, seat-depth extension adjustment automatic synchro-adjustment, tension control Plastic frame	SEK	SEK	SEK	SEK	SEK
		7665	7823	8096	8715	9681	10773
Additional charge/reduced prices Height-adjustable lumbar support Polyester fabric in light gray or white		536 95	536 95	536 95	536 95	536 95	536 95
Polished aluminum frame		977	977	977	977	977	977
High-luster polished aluminum frame		1292	1292	1292	1292	1292	1292
Bright chrome-plated aluminum frame		2027	2027	2027	2027	2027	2027
Electrically conductive casters		515	515	515	515	515	515
Without armrests		-871	-871	-871	-871	-871	-871
		38	47	51 54 58	60 64 65 66 68	91 92	74

All task chairs have casters for soft flooring (e. g. carpets). Please order with soft casters (at no extra charge) for hard flooring (e. g. stone, parquet) Electrically conductive casters (only if an aluminum frame is chosen) available for an extra charge.



				60 64 65 66 68	91 92	74
	38	47	51 54 58			
	SEK	SEK	SEK	SEK	SEK	SEK
Counter stool □125/138 □66 □64 □67/80 □46 □43						
						
181/11 with seat and backrest upholstery with 3D armrests height is precision adjustable adjustable backrest height and seat-depth extension automatic synchro-adjustment, tension control, with bright chrome-plated foot ring (precision- adjustable height) Polished aluminum frame	11319	11666	11949	12569	13524	17147
Additional charge/reduced prices Seat and backrest shell and 3D armrests white through-dyed (armrest pad always black-gray)	1523	1523	1523	1523	1523	1523
Bright chrome-plated aluminum frame	1050	1050	1050	1050	1050	1050
Without armrests	-871	-871	-871	-871	-871	-871
				60 64 65 66 68	91 92	74
	38	47	51 54 58			
	SEK	SEK	SEK	SEK	SEK	SEK
Standard height backrest □80 □55 □60 □43						
						
183/3 with seat cushioning and backrest without upholstery, bright chrome-plated outer rail up to 5 can be stacked free-standing and up to 8 on a four-wheeled trolley not stackable when covered in leather, plastic covered armrests Bright chrome-plated frame	5712	5859	5996	6290	6678	8285
Additional charge/reduced prices Seat/backrest shell and armrest pad white through-dyed Back cushioning Plastic outer rail, color-matched with the shell	420 735 -703	420 924 -703	420 956 -703	420 998 -703	420 1061 -703	420 2079 -703
						74
Standard height backrest □80 □55 □60 □43						
						
183/5 with seat and with seat and backrest upholstery, not stackable, with wool fleece pad and side facings, upholstered armrest pads, covered in leather with top stitching Bright chrome-plated frame						16548
Additional charge/reduced prices Seat and backrest shell fully covered in leather at the rear Solid wood armrests						2867 -2205

All counter chairs come with multipurpose casters.
All cantilever chairs are fitted with anti-tilt stoppers as the standard design for soft flooring (e. g. carpets). For hard floorings (e. g. stone) please order with soft glides, for wooden floorings (e. g. parquet) please order with extra felt glides (at no extra charge in each case).

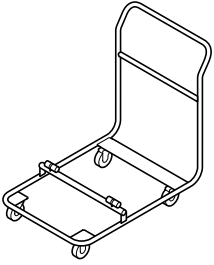


Four-wheeled trolley

183
for 8 stackable cantilever chairs

SEK

6048

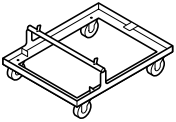


Four-wheeled trolley

186
for 6 multipurpose chairs

SEK

4011



184 Range IN

Design: wiege



Technical details

Function

An office task chair with Trimension®, integrated synchronously supporting 3D kinematics which allows the right-hand and left-hand half of the chair to be tilted in any direction via two flexible swing swivel arms. The goal is to encourage the natural range of motion the pelvis is capable of which includes flexing, extending and moving it sideways to rotating it. The combination of the 3D synchronous adjustment mechanism with a highly elastic seat and back guarantees the chair adapts automatically to any movement made or posture adopted by the person sitting on it. As a result, the body is supported in any position and maintains its center of gravity.

The counter pressure, which provides support in any direction moved in, is precision adjustable for people weighing from 45 to 140 kg by changing the elasticity. The backrest has optional, height-adjustable lumbar support (in six lockable positions of up to 60 mm). The backrest and seat can be locked in a neutral sitting position, the 3D forward tilt of 5° can be activated at the touch of a button in order to harness the maximum range of motion.

The seating height can be precisely adjusted at the touch of a button between 400 mm and 520 mm with a DIN 4550-compliant gas lift. Seat depth: 430 mm, optionally with seat depth that can be adjusted while sitting down in 4 lockable positions of 400 to 450 mm. (The height of the elevated seating position (ESP) models is precision adjustable from between 460 mm and 640 mm and the counter chairs between 650 mm and 780 mm).

Frame

Task chairs

Five-star base made of black through-dyed, fiberglass-reinforced polyamide, optionally of die-cast aluminum, coated, polished or high-luster polished. Twin-wheel swivel casters with load-dependent braking, made of black DIN EN 12529-compliant polypropylene as the standard version for carpets, optionally with gray tire made of polyurethane for hard flooring. Casters optionally electrically conductive.

Gas lift covered by telescopic protective tube made of black through-dyed polypropylene. Mechanism shell made of die-cast aluminum, coated matte black with black through-dyed polypropylene bellows and thermoplastic elastomer to accommodate the flexibly mounted central spring, knob to adjust the counter pressure made of polyamide (for people weighing from 45 to 140 kg). Each chair has two swivel arms which can move independently of one another, made of die-cast aluminum, coated, matte polished or high-luster polished, with protective caps made of polypropylene.

Counter stool

Star base from the ON 170 range, with additional height-adjustable, bright chrome-plated foot ring, with lock screw to affix it and twin-wheel swivel casters with load-dependent braking.

24-hour chairs

Always with die-cast aluminum star base, with extra swivel arm supports and high-performance covers. Designed for people weighing up to 150 kg, the models also comply with the British Standard.

Seat-backrest element

Unitary, highly elastic, and flexibly suspended seat-backrest element made of high-performance polyamide.

Seat shell made of black or white through-dyed polyamide with polypropylene seat upholstery panel. Ergonomic polyurethane seat cushioning with CFC-free foam, covered in Racer, optionally also with Formstrick (form-fit knit) that offers different support zones, in the same material as the backrest cover. Or with fabric covers from the Wilkhahn fabric collection, then with facings sewn-in and deep top stitching lengthwise to create contours as well as side facings in the same material and color. When optional soft padding is chosen, more defini-

Task chairs	Star base	Swivel arms	Mechanism shell
50	Plastic	Coated black matte or with a silver satin finish	Coated black matte, flexible mechanism shell cover and tension control knob made of black through-dyed plastic.
52	Polished aluminum	Coated black matte or with a silver satin finish, or polished	Coated black matte, flexible mechanism shell cover and tension control knob made of black through-dyed plastic.
60	Coated with a silver satin finish (RAL9006)	Coated with a silver satin finish	Coated black matte, flexible mechanism shell cover and tension control knob made of black through-dyed plastic.
72	High-luster polished aluminum	Coated black matte or with a silver satin finish, or high-luster polished	Coated black matte, flexible mechanism shell cover and tension control knob made of black through-dyed plastic.
80	Coated black matte (RAL9005)	Coated black matte	Coated black matte, flexible mechanism shell cover and tension control knob made of black through-dyed plastic.
81	Coated turquoise matte (RAL230 60 30)	Coated turquoise matte	Coated black matte, flexible mechanism shell cover and tension control knob made of black through-dyed plastic.
82	Coated gray matte (RAL7040)	Coated gray matte	Coated black matte, flexible mechanism shell cover and tension control knob made of black through-dyed plastic.
83	Coated orange matte (RAL2001)	Coated orange matte	Coated black matte, flexible mechanism shell cover and tension control knob made of black through-dyed plastic.
84	Coated red matte (RAL3003)	Coated red matte	Coated black matte, flexible mechanism shell cover and tension control knob made of black through-dyed plastic.



ned edges because of the higher quantity of foam and all fabric covers with upholstered facings at the side are in the same material and color. Form-fit knit is not available in combination with soft padding. Optional seat-depth extension, which can be adjusted while sitting in 4 lockable positions from 40 to 45 cm. Then standard and soft padding with side facings in Racer, color-matched when the fabric cover is Racer, in black (37/99) for all other fabrics.

Seat upholstery panel, cushioning and covers are replaceable.

The back section is the frame, optionally with Hytre!® lumbar support (which is retrofittable at any time), comes in black or white to match the seat shell and is adjustable in height by 60 mm in six lockable positions. The back is covered in Formstrick (form-fit knit) which includes different elasticity for flexible and supporting zones, optional two-ply cover made of Formstrick with integrated upholstery foam with different support zones. Colors from the Wilkhahn sample card.

Optional headrest made of through-dyed polyamide, in black or white to match the color of the frame, height can be adjusted by 60 mm in 6 lockable positions, with a 125-degree tilt function, which allows the depth to be adjusted by 50 mm. Upholstered, covered in 37 Racer or Evida 58 fabric, color-matched with the

backrest cover, or in black. Headrest not possible when the chair has a clothes hanger The headrest can be retrofitted on request.

Armrests

Armrests made of fiberglass-reinforced, black through-dyed polyamide.

1D armrests whose height is adjustable in 10 lockable positions by 100 mm, in the case of 3D armrests the armrest pads can also be swiveled 50 mm in depth and by 25 degrees inward and outward, in the case of 4D armrests, each can also be adjusted in width by 25 mm.

Armrest pads made of black through-dyed polypropylene, optionally of polyurethane foam. Also optionally without armrests.

Standards

The IN task chairs comply with the type A DIN EN 1335 office-chair, ANSI/BIFMA X5.1 and IGR standards.



www.tuv.com
ID 1000000000



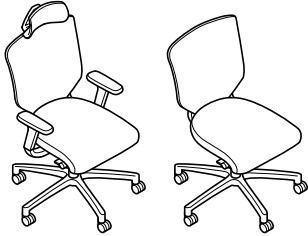
Information

If very damp, the elasticity of the Formstrick can slightly slacken, but will regain its original shape when it dries.



Medium-height backrest

101/113 H 69 H 66
40/52 H 46 H 43



184/7

with seat cushioning,
back covered with single-ply form-fit knit
seat and backrest frame optionally in black or
white,
with 1D armrests, armrest pads made of PP
precision-adjustable height,
Trimension, tension control,
optionally with a 3D forward tilt of 5° that can be
activated (please state when ordering)
Plastic star base, aluminum-coated swivel arms

Additional charge/reduced prices

Aluminum coated star base and swivel arms
Polished aluminum star base, coated swivel arms
High-luster polished aluminum star base, coated
swivel arms
Aluminum polished star base and swivel arms
Aluminum high-luster polished star base and
swivel arms

Soft padding
Seat-depth extension, approx. 40 to 45 cm

Back covered in Formstrick knit, two-ply, with
integrated upholstery foam with different
support zones
Height-adjustable lumbar support
Headrest (cover 37 / Racer, color-matched with
the backrest cover or in black)
Headrest (cover 58 / Evida)

3D armrests, armrest pads made of PP
4D armrests, armrest pads made of PP
Armrest pads made of polyurethane foam for 1D,
3D and 4D armrests
Electrically conductive casters
Without armrests

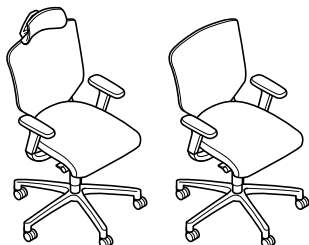
	37 38	41	51 54 58	60 64 65 66 68	91 92
	SEK	SEK	SEK	SEK	SEK
	8232	8379	9156	9555	10164
Aluminum coated star base and swivel arms	609	609	609	609	609
Polished aluminum star base, coated swivel arms	609	609	609	609	609
High-luster polished aluminum star base, coated swivel arms	609	609	609	609	609
Aluminum polished star base and swivel arms	1344	1344	1344	1344	1344
Aluminum high-luster polished star base and swivel arms	1344	1344	1344	1344	1344
Soft padding	116	116	116	116	116
Seat-depth extension, approx. 40 to 45 cm	1155	1302	1302	1323	1355
Back covered in Formstrick knit, two-ply, with integrated upholstery foam with different support zones	609	609	609	609	609
Height-adjustable lumbar support	189	189	189	189	189
Headrest (cover 37 / Racer, color-matched with the backrest cover or in black)	1197	1197	1197	1197	1197
Headrest (cover 58 / Evida)	1197	1197	1197	1197	1197
3D armrests, armrest pads made of PP	294	294	294	294	294
4D armrests, armrest pads made of PP	557	557	557	557	557
Armrest pads made of polyurethane foam for 1D, 3D and 4D armrests	126	126	126	126	126
Electrically conductive casters	515	515	515	515	515
Without armrests	-850	-850	-850	-850	-850

All task chairs have casters for soft flooring (e. g. carpets). Please order with soft casters (at no extra charge) for hard flooring (e. g. stone, parquet) Electrically conductive casters (only if an aluminum frame is chosen) available for an extra charge.



**Medium-height backrest
elevated sitting position (ESP)**

■ 105/119 ■ 69 ■ 66
■ 44/58 ■ 46 ■ 43



184/72

with seat cushioning,
back covered with single-ply form-fit knit
seat and backrest frame optionally in black or
white,
with 1D armrests, armrest pads made of PP
precision-adjustable height,
Trimension, tension control,
optionally with a 3D forward tilt of 5° that can be
activated (please state when ordering)
Plastic star base, aluminum-coated swivel arms

Additional charge/reduced prices

Aluminum coated star base and swivel arms
Polished aluminum star base, coated swivel arms
High-luster polished aluminum star base, coated
swivel arms
Aluminum polished star base and swivel arms
Aluminum high-luster polished star base and
swivel arms

Soft padding
Seat-depth extension, approx. 40 to 45 cm

Back covered in Formstrick knit, two-ply, with
integrated upholstery foam with different
support zones

Height-adjustable lumbar support
Headrest (cover 37 / Racer, color-matched with
the backrest cover or in black)

Headrest (cover 58 / Evida)

3D armrests, armrest pads made of PP

4D armrests, armrest pads made of PP

Armrest pads made of polyurethane foam for 1D,
3D and 4D armrests

Electrically conductive casters

Without armrests

	37 38	41	51 54 58	60 64 65 66 68	91 92
	SEK	SEK	SEK	SEK	SEK
	9114	9261	10038	10437	11046
Aluminum coated star base and swivel arms	609	609	609	609	609
Polished aluminum star base, coated swivel arms	609	609	609	609	609
High-luster polished aluminum star base, coated swivel arms	609	609	609	609	609
Aluminum polished star base and swivel arms	1344	1344	1344	1344	1344
Aluminum high-luster polished star base and swivel arms	1344	1344	1344	1344	1344
Soft padding	116	116	116	116	116
Seat-depth extension, approx. 40 to 45 cm	•	•	•	•	•
Back covered in Formstrick knit, two-ply, with integrated upholstery foam with different support zones	609	609	609	609	609
Height-adjustable lumbar support	189	189	189	189	189
Headrest (cover 37 / Racer, color-matched with the backrest cover or in black)	1197	1197	1197	1197	1197
Headrest (cover 58 / Evida)	1197	1197	1197	1197	1197
3D armrests, armrest pads made of PP	294	294	294	294	294
4D armrests, armrest pads made of PP	557	557	557	557	557
Armrest pads made of polyurethane foam for 1D, 3D and 4D armrests	126	126	126	126	126
Electrically conductive casters	515	515	515	515	515
Without armrests	-850	-850	-850	-850	-850

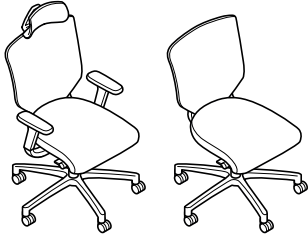
• available

All task chairs have casters for soft flooring (e. g. carpets). Please order with soft casters (at no extra charge) for hard flooring (e. g. stone, parquet) Electrically conductive casters (only if an aluminum frame is chosen) available for an extra charge.



24-hour chair

101/113 H 69 H 66
40/52 H 46 H 43



184/8

with seat cushioning,
back covered with single-ply form-fit knit
seat and backrest frame optionally in black or
white,
with 1D armrests, armrest pads made of PP
precision-adjustable height,
Trimension, tension control,
optionally with a 3D forward tilt of 5° that can be
activated (please state when ordering)
Aluminum coated star base and swivel arms

Additional charge/reduced prices

Polished aluminum star base, coated swivel arms
(at no extra charge)
High-luster polished aluminum star base, coated
swivel arms (at no extra charge)
Aluminum polished star base and swivel arms
Aluminum high-luster polished star base and
swivel arms

Soft padding
Seat-depth extension, approx. 40 to 45 cm
Electrically conductive casters
Without armrests

Back covered in Formstrick knit, two-ply, with
integrated upholstery foam with different
support zones
Height-adjustable lumbar support
Headrest (cover 37 / Racer, color-matched with
the backrest cover or in black)
Headrest (cover 58 / Evida)
3D armrests, armrest pads made of PP
4D armrests, armrest pads made of PP
Armrest pads made of polyurethane foam for 1D,
3D and 4D armrests

	37	41	54	66 68	91 92
	SEK	SEK	SEK	SEK	SEK
	10920	11130	12107	12548	13241
	•	•	•	•	•
	•	•	•	•	•
	735	735	735	735	735
	756	756	756	756	756
	116	116	116	116	116
	1155	1302	1302	1323	1355
	515	515	515	515	515
	-850	-850	-850	-850	-850
	609	609	609	609	609
	189	189	189	189	189
	1197	1197	1197	1197	1197
	1197	1197	1197	1197	1197
	294	294	294	294	294
	557	557	557	557	557
	126	126	126	126	126

• available

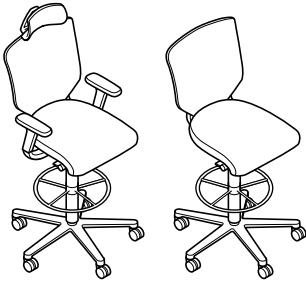
All task chairs have casters for soft flooring (e. g. carpets). Please order with soft casters (at no extra charge) for hard flooring (e. g. stone, parquet) Electrically conductive casters (only if an aluminum frame is chosen) available for an extra charge.



	37 38	41	51 54 58	60 64 65 66 68	91 92
	SEK	SEK	SEK	SEK	SEK
Aluminum coated star base and swivel arms	11592	11739	12516	12915	13524
Aluminum polished star base and swivel arms	735	735	735	735	735
Soft padding	116	116	116	116	116
Seat-depth extension (approx. 400 to 450 mm)	1155	1302	1302	1323	1355
Back covered in Formstrick knit, two-ply, with integrated upholstery foam with different support zones	609	609	609	609	609
Height-adjustable lumbar support	189	189	189	189	189
Headrest (cover 37 / Racer, color-matched with the backrest cover or in black)	1197	1197	1197	1197	1197
Headrest (cover 58 / Evida)	1197	1197	1197	1197	1197
3D armrests, armrest pads made of PP	294	294	294	294	294
4D armrests, armrest pads made of PP	557	557	557	557	557
Armrest pads made of polyurethane foam for 1D, 3D and 4D armrests	126	126	126	126	126
Electrically conductive casters	515	515	515	515	515
Without armrests	-850	-850	-850	-850	-850

Counter stool

- 126/139 ■ 69 ■ 66
- 65/78 ■ 46 ■ 43



184/1

with seat cushioning,
back covered with form-fit knit, single ply,
seat and backrest frame optionally in black or
white,
with 1D armrests, armrest pads made of PP
precision-adjustable height,
Trimension tension control,
without 3D forward tilt of 5°,
with bright chrome-plated foot ring (precision-
adjustable height)
Aluminum coated star base and swivel arms

Additional charge/reduced prices

Aluminum polished star base, coated swivel arms
(at no extra charge)

Aluminum polished star base and swivel arms

Soft padding

Seat-depth extension (approx. 400 to 450 mm)

Back covered in Formstrick knit, two-ply, with
integrated upholstery foam with different
support zones

Height-adjustable lumbar support

Headrest (cover 37 / Racer, color-matched with
the backrest cover or in black)

Headrest (cover 58 / Evida)

3D armrests, armrest pads made of PP

4D armrests, armrest pads made of PP

Armrest pads made of polyurethane foam for 1D,
3D and 4D armrests

Electrically conductive casters

Without armrests

• available

All counter chairs come with multipurpose casters.

186 Range Metrik

Design: white ID



Technical details

Function

The Metrik cantilever chair stands apart for its consistently integrated design approach. The way the components are integrated plays with contrasts such as distinctiveness and neutrality, comfort and an understated appeal, as well as modernity and timeless design. As a result, Metrik can be combined with a variety of table concepts and office chairs. Six colors for the body and frame, combined with a wide variety of covers and colors, offer highly scalable design options. To suit preferences, Metrik either complements the overall design concept or purposely adds a splash of color.

Chairs

Frame

Tubular steel frame optionally in a textured matte finish, coated in white, black, gray, gray-beige, bright chrome-plated or black chrome-plated, with black polyamide anti-tilt stopper as the standard version for carpets, optionally with multipurpose glides for hard flooring (e.g. stone), please order with extra felt glides for wooden flooring (e.g. parquet). Stacking buffer made of plastic to match the shells and colour of the frame.

Please note

Stacking versions with coated frames can cause colour to rub off, which is not covered by our guarantee. The same applies

when inline connectors are used. We recommend chrome-plated versions for circumstances like these.

Seat and backrest

Unitary seat and backrest shell with integrated armrests made of through-dyed, fiberglass-reinforced polyamide the same as the base frame, optionally with a textured matte finish coated in white, black, gray or gray-beige. Replaceable seat cushioning, consisting of seat upholstery panel and covered polyurethane one piece molded foam. Type with optional, replaceable back cushioning the same as the seat cushioning. Weight 8.6 kg

Accessories

Inline connectors (2 in each set) made of black plastic.

Standards

The Metrik cantilever chairs comply with DIN EN 16139-L1 and ANSI/BIFMA X5.1 standards. In compliance with the DIN EN 16139-L1 office-chair standard, up to 4 chairs can be stacked vertically.



www.tuv.com
ID 1000000000

Information

When exposed to ultra violet rays for long periods of time, the colors of plastics can change slightly.

Cantilever chair

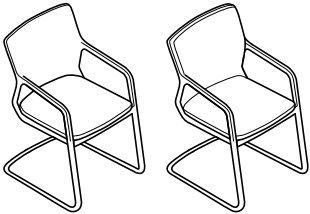
Base frame

51	Bright chrome-plated
77	Black chrome-plated
85	Coated gray with a textured matte finish (Pantone Cool Gray 10 C)
86	Coated gray-beige with a textured matte finish (Pantone 7530 C)
90	Coated with a black textured matte finish (RAL 9011)
91	Coated white with a textured matte finish (RAL 9016)



Standard height backrest

■87 ■57 ■60
■45



186/3

Up to 5 stackable free-standing,
with seat cushioning
Coated frame

Additional charge/reduced prices

Bright chrome-plated frame
Black chrome-plated frame
with seat and backrest upholstery

Accessories

187 Inline connector set
2 items

185 Writing tablet
fold up, for fitting to the armrest

186 Four-wheeled trolley
for 8 multipurpose chairs

	37	41	51	60	64	65	66	68	91	74
	38	47	54	58	66	68			92	
	SEK	SEK	SEK	SEK	SEK	SEK	SEK	SEK	SEK	SEK
	4011	4484	4641	4809	5093	6027				
	431	431	431	431	431	431				
	872	872	872	872	872	872				
	1050	1187	1271	1323	1386	1995				
	95	95	95	95	95	95				
	1386	1386	1386	1386	1386	1386				
	4011	4011	4011	4011	4011	4011				

SEK

Writing tablet



185

fold up,
for fitting to the armrest

1386

Four-wheeled trolley

186

for 8 multipurpose chairs

4011

Inline connector set

187

2 items

95

All cantilever chairs are optionally available with anti-tilt stoppers for soft floorings (e. g. carpets), with multipurpose glides for hard floorings (e. g. stone), for wooden floorings (e. g. parquet) please order with extra felt glides.

187 Range AT

Design: Wilkhahn



Technical details

Function

Free-to-move office task chair with Trimension®, integrated synchronously supporting 3D kinematics. The self-centering suspension of the seat shell is combined with automatic weight adjustment and the chair optionally comes with the ability to preset the automatic weight adjustment in ten increments to suit personal preferences. Trimension® activates the natural range of motion the human pelvis is capable of and which matches the way the joints function, from flexing, extending, leaning sideways or rotating the pelvis. When moving synchronously backwards and forwards, the angle of the tilt ranges from 12° in the seat and up to 26° in the backrest, optionally with a 3D forward tilt of up to 5° that can be activated, during which the backrest is raised synchronously by 25 mm so that the lumbar support is always in the right position. The seat and back can be tilted sideways from the horizontal by up to 12°. At the same time, the counter pressure adjusts automatically to any posture or movement so that the body always maintains its center of gravity.

AT is ideal for people weighing from 45 to 140 kg.

The backrest has height-adjustable lumbar support (in eight lockable positions of up to 60 mm). The backrest and seat can be locked in a neutral horizontal 0-position, the optional 5° 3D forward tilt can be activated by lifting the seat and back. The seating height can be precision adjusted at the touch of a button between 400 mm and 520 mm with a DIN 4550-compliant, precision-adjustable gas lift, optionally with a contact suppression feature, then the seating height is between 420 mm - 530 mm.

Seat depth: 430 mm, optionally integrated, users can turn a knob while sitting to precision adjust the seat-depth extension from 390 mm to 450 mm. The height of the elevated sitting position (ESP)

models is precision adjustable from between 430 mm and 610 mm and the counter chairs between 650 mm and 770 mm.

Frame

Task chairs

Five-star base made of black through-dyed, fiberglass-reinforced polyamide, optionally of die-cast aluminum, coated, polished or high-luster polished. Twin-wheel swivel casters with load-dependent braking, made of black DIN EN 12529-compliant polypropylene as the standard version for carpets, optionally with gray tire made of polyurethane for hard flooring. Casters optionally electrically conductive.

The gas lift is covered by a telescopic protective tube made of black or white through-dyed polypropylene (does not apply to the ESP version). The mechanism shell is made of black or white through-dyed, fiberglass-reinforced polyamide with a cover made of black or white through-dyed polypropylene.

The backrest bearer to accommodate the seat and backrest is made of black or white through-dyed, fiberglass-reinforced polyamide with a central steel joint.

Counter stool

With extra height-adjustable foot ring, bright chrome-plated, with lock screw to affix it and twin-wheel swivel casters with load-dependent braking.

Seat and back

Models 187/7, 187/8, 187/9, 187/72, 187/1

Unitary and highly elastic self-centering seat and backrest shell suspended on the backrest bearer made of black or white through-dyed glass-bead reinforced polypropylene.

Three backrest heights (medium height, advanced height, advanced height with headrest and neck rest), backrest shell optionally covered in fabric or leather, neck rest made of polyurethane foam, covered in black or gray leather.

When leather 74 is chosen, in the same material and color as the backrest cover. Seat and back cushioning made of polyurethane with CFC-free foam, as replaceable upholstery element with covers from the Wilkhahn fabric and leather collection. Ergonomic, with seat cushioning with higher edges at the sides, made of molded foam, covers without side facings. When optional soft padding is chosen, more defined edges because of the higher quantity of foam and all fabric covers with facings at the side are in the same material and color. With optional seat-depth extension from 39 to 45 cm that is precision adjustable by turning a knob. Then standard and soft padding with side facings in Racer, color-matched when the fabric cover is Racer, optionally in black (37/99), anthracite (37/25) and light gray (37/95) for all other fabrics. Leather for all types of upholstery with facings all the way round in the same material and color. Optional plastic lumbar support between the seat and backrest shell and backrest cushioning, height-adjustable by 6 cm in eight lockable positions.

AT Mesh models 187/71, 187/73, 187/11

The seat and backrest element is suspended in a self-centering manner on the backrest bearer and the back is a mesh-covered frame. The mesh is made of 80% post-consumer-recycled polyester and 20% elastomer. The backrest frame is made of black or

Task chairs

Star base

50	Plastic
52	Polished aluminum
72	High-luster polished aluminum
90	Coated with a black textured matte finish (RAL9011)
91	Coated white with a textured matte finish (RAL9016)



white, through-dyed, fiberglass-reinforced polyamide, which is screwed to the seat shell made of black or white through-dyed, glass-bead reinforced polypropylene, with a seat shell and backrest frame made of black or white through-dyed plastic with a polypropylene seat upholstery panel. Seat cushioning made of polyurethane with CFC-free foam, as replaceable upholstery element with covers from the Wilkhahn fabric and leather collection. Ergonomic, with seat cushioning with higher edges at the sides, made of molded foam, covers without side facings.

When optional soft padding is chosen, more defined edges because of the higher quantity of foam and all fabric covers with facings at the side are in the same material and color. With optional seat-depth extension from 39 to 45 cm that is precision adjustable by turning a knob. Then standard and soft padding with side facings in Racer, color-matched when the fabric cover is Racer, optionally in black (37/99), anthracite (37/25) and light gray (37/95) for all other fabrics. Leather for all types of upholstery with facings all the way round in the same material and color.

Optionally with a polypropylene lumbar support, which is in black or white to match the color of the frame and height-adjustable by 6 cm in six lockable positions, optionally additionally adjustable in depth by up to 1.5 cm by turning a knob made of fiberglass-reinforced polyamide that is retrofittable at any time.

Optional backrest frame with an upholstered headrest in the same color as the frame in through-dyed, fiberglass-reinforced polyamide, height-adjustable by 6 cm in 6 lockable positions and can be tilted forward in 4 lockable positions by up to 125° (depth adjustable by up to 5 cm). Cover in the same material and color as the backrest or in black.

Optional armrests

Armrests made of fiberglass-reinforced, black or white through-dyed polyamide with armrest pads made of gray or black through-dyed polypropylene, optionally with armrest pads made of gray or black through-dyed polyurethane foam.

The height of 1D armrests can be adjusted in ten lockable positions by 100 mm, the depth of the armrest pads on 3D armrests can be adjusted by 50 mm and the width by 25 mm in each case, 4D armrests can also be pivoted inward and outward by 25°.

Standards

The AT task chairs comply with the type A DIN EN 1335 office chair, ANSI/BIFMA X5.1 and IGR standards.



www.tuv.com
ID 100000000



www.blauer-engel.de/uz117

• emissionsarm
• geringer Schadstoffgehalt

All components used to adjust the chair (slide buttons and levers to adjust and lock the height, components for adjusting the lumbar support and pull-out knob for optional seat-depth extension) are made of gray through-dyed plastic.



Medium-height backrest

98/110 H67 H64
40/52 H50 H43



187/7

with seat- and back cushioning, seat- and backrest shell, automatic synchro-adjustment mechanism in black height-adjustable lumbar support without armrests precision-adjustable height, 3D kinematics with automatic weight adjustment, optionally with customized presetting Trimension Plastic star base

Additional charge/reduced prices

Coated aluminum star base
Polished aluminum star base
High-luster polished aluminum star base
3D forward tilt of 5° can be activated

Soft padding
Seat-depth extension, approx. 39 to 45 cm
Contact suppression feature (seating height approx. 42 – 53 cm)

1D armrests, armrest pads made of PP
3D armrests, armrest pads made of PP
4D armrests, armrest pads made of PP
Armrest pads made of polyurethane foam for 1D, 3D and 4D armrests
Coat hanger
Electrically conductive casters

Seat-/backrest shell covered in fabric on the rear (fabric 68 not possible)
Seat and backrest shell, synchro-adjustment mechanism and, if applicable, armrests in white

	37 38	47	51 54	60 64 65 66 68	91 92	74
	SEK	SEK	SEK	SEK	SEK	SEK
	6311	6825	7308	7665	8264	10311
Coated aluminum star base	651	651	651	651	651	651
Polished aluminum star base	1040	1040	1040	1040	1040	1040
High-luster polished aluminum star base	1166	1166	1166	1166	1166	1166
3D forward tilt of 5° can be activated	263	263	263	263	263	263
Soft padding	116	116	116	116	116	116
Seat-depth extension, approx. 39 to 45 cm	525	662	662	662	662	998
Contact suppression feature (seating height approx. 42 – 53 cm)	315	315	315	315	315	315
1D armrests, armrest pads made of PP	788	788	788	788	788	788
3D armrests, armrest pads made of PP	1302	1302	1302	1302	1302	1302
4D armrests, armrest pads made of PP	1586	1586	1586	1586	1586	1586
Armrest pads made of polyurethane foam for 1D, 3D and 4D armrests	189	189	189	189	189	189
Coat hanger	683	683	683	683	683	683
Electrically conductive casters	515	515	515	515	515	515
Seat-/backrest shell covered in fabric on the rear (fabric 68 not possible)		851	945	1355	1764	
Seat and backrest shell, synchro-adjustment mechanism and, if applicable, armrests in white	336	336	336	336	336	336

All task chairs are fitted with casters for soft flooring (e.g. carpets). Please order with soft casters (at no extra charge) for hard flooring (e.g. stone, parquet). Electrically conductive casters (only if an aluminum frame is chosen) available for an extra charge.



Medium-height backrest

101/113 H67 H64
40/52 H50 H43



187/71

with seat cushioning, mesh-covered backrest seat shell, backrest frame and synchro-adjustment mechanism in black, without armrests
precision-adjustable height, 3D kinematics with automatic weight adjustment optionally with customized presetting
Trimension
Plastic star base

Additional charge/reduced prices

Coated aluminum star base
Polished aluminum star base
High-luster polished aluminum frame
3D forward tilt of 5° can be activated
Contact suppression feature (seating height approx. 42 – 53 cm)

Soft padding
Seat-depth extension, approx. 39 to 45 cm

Lumbar support
Lumbar support, adjustable height and depth
Headrest (cover 34 / Vivid, color-matched with the backrest cover or in black)

1D armrests, armrest pads made of PP
3D armrests, armrest pads made of PP
4D armrests, armrest pads made of PP
Armrest pads made of polyurethane foam for 1D, 3D and 4D armrests
Coat hanger
Electrically conductive casters
Seat shell and backrest frame, synchro-adjustment mechanism, if necessary white armrests

	37 38	47	51 54	60 64 65 66 68	91 92	74
	SEK	SEK	SEK	SEK	SEK	SEK
	6311	6825	7308	7665	8264	9303
	651	651	651	651	651	651
	1040	1040	1040	1040	1040	1040
	1166	1166	1166	1166	1166	1166
	263	263	263	263	263	263
	315	315	315	315	315	315
	116	116	116	116	116	116
	525	662	662	662	662	998
	126	126	126	126	126	126
	431	431	431	431	431	431
	1040	1040	1040	1040	1040	1040
	788	788	788	788	788	788
	1302	1302	1302	1302	1302	1302
	1586	1586	1586	1586	1586	1586
	189	189	189	189	189	189
	683	683	683	683	683	683
	515	515	515	515	515	515
	336	336	336	336	336	336



High backrest

□ 110/122 □ 67 □ 64
□ 40/52 □ 50 □ 43



187/8

with seat- and back cushioning, seat- and backrest shell, automatic synchro-adjustment mechanism in black height-adjustable lumbar support without armrests precision-adjustable height, 3D kinematics with automatic weight adjustment, optionally with customized presetting Trimension Plastic star base

Additional charge/reduced prices

Coated aluminum star base
Polished aluminum star base
High-luster polished aluminum star base
3D forward tilt of 5° can be activated

Soft padding
Seat-depth extension, approx. 39 to 45 cm
Contact suppression feature (seating height approx. 42 – 53 cm)

1D armrests, armrest pads made of PP
3D armrests, armrest pads made of PP
4D armrests, armrest pads made of PP
Armrest pads made of polyurethane foam for 1D, 3D and 4D armrests
Coat hanger
Electrically conductive casters

Seat-/backrest shell covered in fabric on the rear (fabric 68 not possible)
Seat and backrest shell, synchro-adjustment mechanism and, if applicable, armrests in white

	37 38	47	51 54	60 64 65 66 68	91 92	74
	SEK	SEK	SEK	SEK	SEK	SEK
	7298	7896	8421	8852	9566	11256
Coated aluminum star base	651	651	651	651	651	651
Polished aluminum star base	1040	1040	1040	1040	1040	1040
High-luster polished aluminum star base	1166	1166	1166	1166	1166	1166
3D forward tilt of 5° can be activated	263	263	263	263	263	263
Soft padding	116	116	116	116	116	116
Seat-depth extension, approx. 39 to 45 cm	525	662	662	662	662	998
Contact suppression feature (seating height approx. 42 – 53 cm)	315	315	315	315	315	315
1D armrests, armrest pads made of PP	788	788	788	788	788	788
3D armrests, armrest pads made of PP	1302	1302	1302	1302	1302	1302
4D armrests, armrest pads made of PP	1586	1586	1586	1586	1586	1586
Armrest pads made of polyurethane foam for 1D, 3D and 4D armrests	189	189	189	189	189	189
Coat hanger	683	683	683	683	683	683
Electrically conductive casters	515	515	515	515	515	515
Seat-/backrest shell covered in fabric on the rear (fabric 68 not possible)		851	945	1355	1764	
Seat and backrest shell, synchro-adjustment mechanism and, if applicable, armrests in white	336	336	336	336	336	336

All task chairs are fitted with casters for soft flooring (e.g. carpets). Please order with soft casters (at no extra charge) for hard flooring (e.g. stone, parquet). Electrically conductive casters (only if an aluminum frame is chosen) available for an extra charge.



High backrest with headrest and neck rest

■ 120/132 ■ 67 ■ 64
■ 40/52 ■ 50 ■ 43



187/9

with seat cushioning,
neck rest covered optionally in 74/99 or
74/34 leather,
seat and backrest shell, synchro-adjustment
mechanism in black
height-adjustable lumbar support
without armrests
precision-adjustable height
3D kinematics with automatic weight adjustment
optionally with customized presetting
Trimension
Plastic star base

Additional charge/reduced prices

Coated aluminum star base
Polished aluminum star base
High-luster polished aluminum star base
3D forward tilt of 5° can be activated

Soft padding
Seat-depth extension, approx. 39 to 45 cm
Contact suppression feature (seating height
approx. 42 – 53 cm)

1D armrests, armrest pads made of PP
3D armrests, armrest pads made of PP
4D armrests, armrest pads made of PP
Armrest pads made of polyurethane foam for 1D,
3D and 4D armrests
Coat hanger
Electrically conductive casters

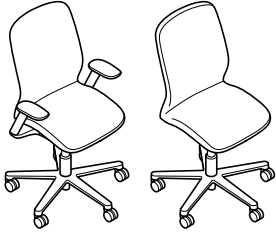
Seat-/backrest shell covered in fabric on the rear
(fabric 68 not possible)
Seat and backrest shell, synchro-
adjustment mechanism and, if applicable,
armrests in white

	37 38	47	51 54	60 64 65 66 68	91 92	74
	SEK	SEK	SEK	SEK	SEK	SEK
	9566	10322	11057	11603	12548	13629
Coated aluminum star base	651	651	651	651	651	651
Polished aluminum star base	1040	1040	1040	1040	1040	1040
High-luster polished aluminum star base	1166	1166	1166	1166	1166	1166
3D forward tilt of 5° can be activated	263	263	263	263	263	263
Soft padding	116	116	116	116	116	116
Seat-depth extension, approx. 39 to 45 cm	525	662	662	662	662	998
Contact suppression feature (seating height approx. 42 – 53 cm)	315	315	315	315	315	315
1D armrests, armrest pads made of PP	788	788	788	788	788	788
3D armrests, armrest pads made of PP	1302	1302	1302	1302	1302	1302
4D armrests, armrest pads made of PP	1586	1586	1586	1586	1586	1586
Armrest pads made of polyurethane foam for 1D, 3D and 4D armrests	189	189	189	189	189	189
Coat hanger	683	683	683	683	683	683
Electrically conductive casters	515	515	515	515	515	515
Seat-/backrest shell covered in fabric on the rear (fabric 68 not possible)		851	945	1355	1764	
Seat and backrest shell, synchro-adjustment mechanism and, if applicable, armrests in white	336	336	336	336	336	336



**Medium-height backrest
elevated sitting position (ESP)**

101/119 H67 H64
43/61 H50 H43



187/72

with seat- and back cushioning,
seat- and backrest shell, automatic synchro-
adjustment mechanism in black
height-adjustable lumbar support
without armrests
precision-adjustable height,
3D kinematics with automatic weight adjustment,
optionally with customized presetting
Trimension
3D forward tilt of 5° can be activated
Plastic star base

Additional charge/reduced prices

Coated aluminum star base
Polished aluminum star base
High-luster polished aluminum star base
Electrically conductive casters

Soft padding
Seat-depth extension (approx. 39 to 45 cm) not
possible in the combination without armrests
and/or plastic star base)

1D armrests, armrest pads made of PP
3D armrests, armrest pads made of PP
4D armrests, armrest pads made of PP
Armrest pads made of polyurethane foam for 1D,
3D and 4D armrests
Coat hanger

Seat-/backrest shell covered in fabric on the rear
(fabric 68 not possible)
Seat and backrest shell, synchro-
adjustment mechanism and, if applicable,
armrests in white

	37 38	47	51 54	60 64 65 66 68	91 92	74
	SEK	SEK	SEK	SEK	SEK	SEK
	7130	7644	8127	8484	9083	11130
Coated aluminum star base	651	651	651	651	651	651
Polished aluminum star base	1040	1040	1040	1040	1040	1040
High-luster polished aluminum star base	1166	1166	1166	1166	1166	1166
Electrically conductive casters	515	515	515	515	515	515
Soft padding	116	116	116	116	116	116
Seat-depth extension (approx. 39 to 45 cm) not possible in the combination without armrests and/or plastic star base)	525	662	662	662	662	998
1D armrests, armrest pads made of PP	788	788	788	788	788	788
3D armrests, armrest pads made of PP	1302	1302	1302	1302	1302	1302
4D armrests, armrest pads made of PP	1586	1586	1586	1586	1586	1586
Armrest pads made of polyurethane foam for 1D, 3D and 4D armrests	189	189	189	189	189	189
Coat hanger	683	683	683	683	683	683
Seat-/backrest shell covered in fabric on the rear (fabric 68 not possible)		851	945	1355	1764	
Seat and backrest shell, synchro-adjustment mechanism and, if applicable, armrests in white	336	336	336	336	336	336

All task chairs are fitted with casters for soft flooring (e. g. carpets). Please order with soft casters (at no extra charge) for hard flooring (e. g. stone, parquet). Electrically conductive casters (only if an aluminum frame is chosen) available for an extra charge.



**Medium-height backrest
elevated sitting position (ESP)**

104/122 H 67 H 64
43/61 H 50 H 43



187/73

with seat cushioning, mesh-covered backrest seat shell, backrest frame and synchro-adjustment mechanism in black, without armrests
precision-adjustable height
3D kinematics with automatic weight adjustment optionally with customized presetting
Trimension
3D 5° forward tilt can be activated
Plastic star base

Additional charge/reduced prices

Coated aluminum star base
Polished aluminum star base
High-luster polished aluminum frame

Soft padding
Seat-depth extension (approx. 39 to 45 cm) not possible in the combination without armrests and/or plastic star base)

Lumbar support
Lumbar support, adjustable height and depth
Headrest (cover 34 / Vivid, color-matched with the backrest cover or in black)

1D armrests, armrest pads made of PP
3D armrests, armrest pads made of PP
4D armrests, armrest pads made of PP
Armrest pads made of polyurethane foam for 1D, 3D and 4D armrests
Coat hanger
Electrically conductive casters
Seat shell and backrest frame, synchro-adjustment mechanism, if necessary white armrests

	37 38	47	51 54	60 64 65 66 68	91 92	74
	SEK	SEK	SEK	SEK	SEK	SEK
	7130	7644	8127	8484	9083	10122
Coated aluminum star base	651	651	651	651	651	651
Polished aluminum star base	1040	1040	1040	1040	1040	1040
High-luster polished aluminum frame	1166	1166	1166	1166	1166	1166
Soft padding	116	116	116	116	116	116
Seat-depth extension (approx. 39 to 45 cm) not possible in the combination without armrests and/or plastic star base)	525	662	662	662	662	998
Lumbar support	126	126	126	126	126	126
Lumbar support, adjustable height and depth	431	431	431	431	431	431
Headrest (cover 34 / Vivid, color-matched with the backrest cover or in black)	1040	1040	1040	1040	1040	1040
1D armrests, armrest pads made of PP	788	788	788	788	788	788
3D armrests, armrest pads made of PP	1302	1302	1302	1302	1302	1302
4D armrests, armrest pads made of PP	1586	1586	1586	1586	1586	1586
Armrest pads made of polyurethane foam for 1D, 3D and 4D armrests	189	189	189	189	189	189
Coat hanger	683	683	683	683	683	683
Electrically conductive casters	515	515	515	515	515	515
Seat shell and backrest frame, synchro-adjustment mechanism, if necessary white armrests	336	336	336	336	336	336



Counter stool

□ 123/135 □ 67 □ 64
□ 65/77 □ 50 □ 43



187/1

with seat- and back cushioning, seat- and backrest shell, automatic synchro-adjustment mechanism in black height-adjustable lumbar support without armrests precision-adjustable height, 3D kinematics with automatic weight adjustment, optionally with customized presetting Trimension with bright chrome-plated foot ring (precision-adjustable height) Coated aluminum star base

Additional charge/reduced prices

Polished aluminum star base
High-luster polished aluminum star base

Soft padding

1D armrests, armrest pads made of PP
3D armrests, armrest pads made of PP
4D armrests, armrest pads made of PP
Armrest pads made of polyurethane foam for 1D, 3D and 4D armrests
Coat hanger

Seat-/backrest shell covered in fabric on the rear (fabric 68 not possible)
Seat and backrest shell, synchro-adjustment mechanism and, if applicable, armrests in white

	37 38	47	51 54	60 64 65 66 68	91 92	74
	SEK	SEK	SEK	SEK	SEK	SEK
	9419	9933	10416	10773	11372	13587
Polished aluminum star base	389	389	389	389	389	389
High-luster polished aluminum star base	515	515	515	515	515	515
Soft padding	116	116	116	116	116	116
1D armrests, armrest pads made of PP	788	788	788	788	788	788
3D armrests, armrest pads made of PP	1302	1302	1302	1302	1302	1302
4D armrests, armrest pads made of PP	1586	1586	1586	1586	1586	1586
Armrest pads made of polyurethane foam for 1D, 3D and 4D armrests	189	189	189	189	189	189
Coat hanger	683	683	683	683	683	683
Seat-/backrest shell covered in fabric on the rear (fabric 68 not possible)		851	945	1355	1764	
Seat and backrest shell, synchro-adjustment mechanism and, if applicable, armrests in white	336	336	336	336	336	336



AT Mesh counter stool

■ 126/138 ■ 67/64 ■ 64
■ 65/77 ■ 50 ■ 43



187/11

with seat cushioning, mesh-covered backrest
seat shell, backrest frame and synchro-
adjustment mechanism in black
without armrests
precision adjustable height
3D kinematics with automatic weight adjustment
optionally with customized presetting
Trimension
with bright chrome-plated foot ring (precision-
adjustable height)
Coated aluminum star base

Additional charge/reduced prices

Polished aluminum star base
High-luster polished aluminum frame

Soft padding

Lumbar support
Lumbar support, adjustable height and depth
Headrest (cover 34 / Vivid, color-matched with the
backrest cover or in black)

1D armrests, armrest pads made of PP
3D armrests, armrest pads made of PP
4D armrests, armrest pads made of PP
Armrest pads made of polyurethane foam for 1D,
3D and 4D armrests
Coat hanger
Seat shell and backrest frame, synchro-
adjustment mechanism, if necessary white
armrests

	37	47	51	60	91	
	38		54	64	92	74
				65		
				66		
				68		
	SEK	SEK	SEK	SEK	SEK	SEK
	9419	9933	10416	10773	11372	12558
Polished aluminum star base	389	389	389	389	389	389
High-luster polished aluminum frame	515	515	515	515	515	515
Soft padding	116	116	116	116	116	116
Lumbar support	126	126	126	126	126	126
Lumbar support, adjustable height and depth	431	431	431	431	431	431
Headrest (cover 34 / Vivid, color-matched with the backrest cover or in black)	1040	1040	1040	1040	1040	1040
1D armrests, armrest pads made of PP	788	788	788	788	788	788
3D armrests, armrest pads made of PP	1302	1302	1302	1302	1302	1302
4D armrests, armrest pads made of PP	1586	1586	1586	1586	1586	1586
Armrest pads made of polyurethane foam for 1D, 3D and 4D armrests	189	189	189	189	189	189
Coat hanger	683	683	683	683	683	683
Seat shell and backrest frame, synchro-adjustment mechanism, if necessary white armrests	336	336	336	336	336	336

20 Range Stitz 2

Design: ProduktEntwicklung Roericht



Technical details

Function

Stitz is a sitting-standing stool with precision-adjustable height via an encapsulated gas lift. Stitz is ideal for people weighing up to 120 kg.

Frame

Black elastomer base filled with quartz sand. Black polyamide base plate.

Seat

Black polyamide seat frame. Cork insert, either treated with hard wax, covered with fabric or embossed leather. Underneath the seat, black polyamide grip to engage the gas lift.

Stitz
63/88 H31



201/1
Cork seat
black frame

SEK

6384

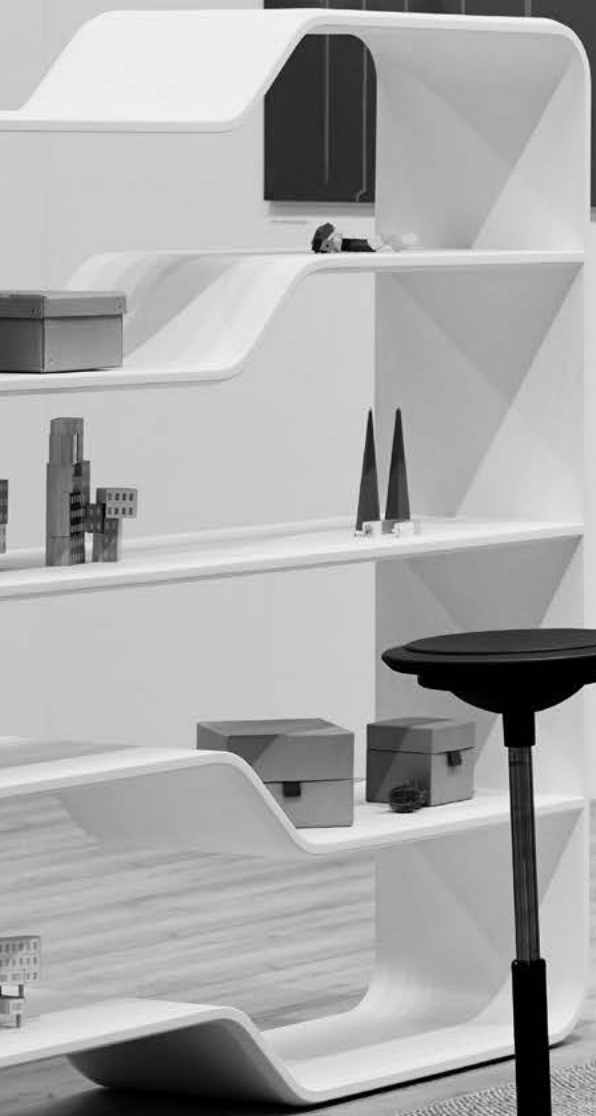
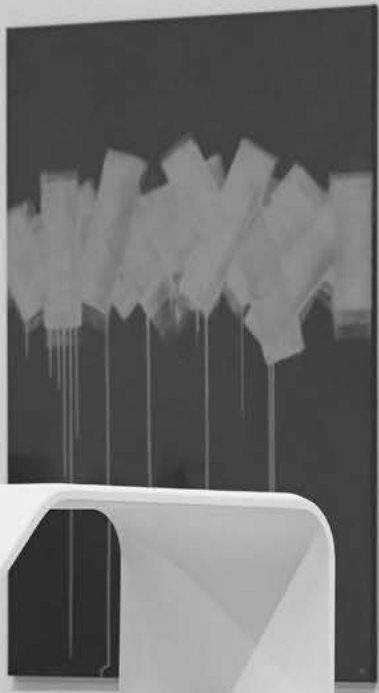
Upholstery material

		60		
		64		
		65	91	
	51	66	92	74
	SEK	SEK	SEK	SEK
	6983	7119	7382	7413

Stitz
63/88 H31



201/2
Black frame



202 Range Stand-up

Design: Thorsten Franck



Further
information

Technical details

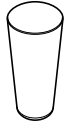
<p>Function An object in motion, when sat on it's turned from a one-legged to stable three-legged piece of furniture.</p>	<p>Body Tapered hollow body made of EPP (expanded polypropylene) with a lid upholstered with cut foam that serves as the seat. Body and seat fully covered with three-dimensional fabric. Tapered base made of</p>	<p>black, non-slip plastic with integrated steel weights and damping cylinder. Carry-strap made of 100% polypropylene in black.</p> <p>Weight Just 4.5 kg</p>	<p>Information In wet or dirty conditions, the base's grip can vary. It can cause scuff marks on light-colored flooring.</p>
--------------------------------------------------------------------------------------------------------------------------------------	-------------------------------------------------------------------------------------------------------------------------------------------------------------------------------------------------------------------------------	--------------------------------------------------------------------------------------------------------------------------------------------------------------------------	-----------------------------------------------------------------------------------------------------------------------------------------

Upholstery material
35

SEK

Stand-up

67 32



<p>202/0101 covered in Fiberflex fabric 35/99: black incl. carry-strap black base</p>	3497
<p>202/0102 covered in Fiberflex fabric 35/89: red incl. carry-strap black base</p>	3497
<p>202/0103 covered in Fiberflex fabric 35/63: light blue incl. carry-strap black base</p>	3497
<p>202/0104 covered in Fiberflex fabric 35/56: green incl. carry-strap black base</p>	3497
<p>202/0105 covered in Fiberflex fabric 35/34: orange incl. carry-strap black base</p>	3497
<p>202/0107 covered in Fiberflex fabric 35/25: anthracite incl. carry-strap black base</p>	3497
<p>202/0108 covered in Fiberflex fabric 35/11: gray incl. carry-strap black base</p>	3497
<p>202/0110 covered in Fiberflex fabric 35/1130: bronze incl. carry-strap black base</p>	3497
<p>202/0111 covered in Fiberflex fabric 35/1110: beige including carry-strap black base</p>	3497
<p>202/0112 covered in Fiberflex fabric 35/8110: sage including carry-strap black base</p>	3497
<p>202/0113 covered in Fiberflex fabric 35/6123: cobalt blue including carry-strap black base</p>	3497

1 SOCIAL TEASER CONTENT



2 INFLUENCERS

BLOGGERS

JOURNALISTS

FACE MANAGERS

2 LOOKALIKE AUDIENCES



4 RETARGET NON-SUBSCRIBERS



etc.



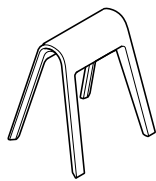
204 Range Sitzbock

Rudolph Schelling Webermann



Technical details

Function A pommel horse seat weighing just 4.8 kg that's ideal for informal interaction in kitchenettes, bistros and workshops and enables a range of different postures: users can lean on it, sit side saddle or position themselves astride it.	Body/frame Four-leg seat made of through-dyed polyethylene in black, white, gray or orange-red with non-slip multipurpose glides. Also suitable for temporary use in outdoor rooms. Up to four Sitzbock pommel horse seats can be stacked across one another. Optional felt blanket in anthracite, a light mottled hue, graphite or mango with a rubber underside which is attached with ten expanding rivets.	Please note: Can be used outdoors. When exposed to ultra violet rays for long periods of time, the colors of plastics can change slightly. Felt is a natural product. Therefore, there can be differences in the color. These differences are not a justified reason for complaint but underscore the material's uniqueness.
--------------------------------------------------------------------------------------------------------------------------------------------------------------------------------------------------------------------------------------------------------------	--------------------------------------------------------------------------------------------------------------------------------------------------------------------------------------------------------------------------------------------------------------------------------------------------------------------------------------------------------------------------------------------------------------------------	-----------------------------------------------------------------------------------------------------------------------------------------------------------------------------------------------------------------------------------------------------------------------------------------------------------------------------------------------

	SEK
Sitzbock H71 H63 H52	
	
204/01 Polyethylene, in black	3885
204/02 Polyethylene, in white	3885
204/03 Polyethylene, in gray	3885
204/04 Polyethylene, in orange-red	3885

Seat pad	204/11 made of felt in graphite	788
	204/12 made of felt in a light mottled hue	788
	204/13 made of felt in anthracite	788
	204/14 made of felt in mango	788



208 Range Landing

Rudolph Schelling Webermann



Technical details

Function

Decorative and sound-absorbent wall relief that can be combined as desired to lean, sit or place things on in aisles, cross-over spaces and staircases in order to encourage users to meet and talk to other people.

Model 208/1 flat element

Core panels made of laminated wood with PUR foam (flame retardant CMHR) upholstered and covered in fabric.

Model 208/2 projecting element

Core panels made of laminated wood and MDF, upholstered with PUR foam (CMHR, flame retardant) and covered in fabric. Can be fitted vertically to lean or horizontally to perch on, or rotated by 180° to make a table-cum-shelf,

which then optionally comes with optional sheet steel surface screwed on from the inside, coated with a textured matt finish in gray.

With two integrated attachments for each edge length that enable users to hang it up and engage it at any right angles and four fittings to mount it to the wall.

		Upholstery material			
		37	54	60	
		38		64	
				66	
		SEK	SEK	SEK	
Landing 	208/1 60 x 60, D 5 flat element	2405	2678	3192	
Landing 	208/2 60 x 60, D 23 Projecting element	3528	3980	4610	
	Additional charge/reduced prices Table rest	872	872	872	



21 Range FS-Line

Design: Klaus Franck, Werner Sauer



Technical details

Function

Task chairs and -armchairs with automatic synchro-adjustment: The seat and backrest tilt adapt automatically to any posture the user adopts. When leaning back, the backrest tension increases proportionately. The person using the chair can adjust the tension precisely. The front position is lockable by engaging the lever. DIN 4550 compliant gas lift for precision-adjustable seating height.

Conference chairs / visitor chairs with automatic synchro-adjustment, but without front locking position, without precision-adjustable height.

Frame

Task chairs

Die-cast aluminum star base, bright chrome-plated, polished or coated.

Twin-wheel swivel casters with load-dependent braking, made of black polyamide compliant with DIN EN 12529 as the standard version for carpets; with gray soft polyurethane tire for hard floors. Casters optionally electrically conductive. Black polyamide glides as the standard version for carpets and in black polyurethane for hard floorings.

Swivel arms in die-cast aluminum, bright chrome-plated or coated in the same color depending on star base (coated black with polished star-base).

Cantilever chair

Frame for models 212/5 in tubular steel, bright chrome-plated or coated; stackable version with bright chrome plated frame only. Frame of model 220 in oval aluminum tubing, bright chrome-plated or coated. Cantilever chair model 212 with anti-tilt stoppers as the standard version for carpeted floors, with additional glides for hard floors, on request with felt insert.

Seat and backrest

Models 211/8 to 213/8

Seat and back shell made of viscoelastic, through-dyed polypropylene with flexible middle section in colors

91 natural white,
92 platinum,
97 Asphalt,
99 black.

Standard armrests in the same material, black.

Backrest of swivel chairs 211 and 213 with integrated, adjustable lumbar support on request. Upholstery: covered molded foam part, replaceable.

Models 220/7 to 220/9

Tubular steel frame with flexible middle section, covered in elastic mesh and molded in open-pore foam, cushioned pad. Integral foam armrests, leather-covered, with fabric covers in black, covered in leather to match the color of the leather. Replaceable cover with stitched fluting, or replaceable cover with integrated flat cushion.

Standards

FS-Line task chairs are compliant with the DIN EN 1335 type B or C office-chair and ANSI/BIFMA X5.1 standards.

The cantilever chairs comply with DIN EN 16139-L1 and ANSI/BIFMA X5.1 standards.



www.tuv.com
ID 1000000000

The FS task chairs comply with the Ergonomics Approved standard.



Please note:

The prices for types with cushioning that includes fabrics and leather provided by the customer are given on request.

Task chairs and armchairs

Star base

51	Bright chrome-plated
52	Polished aluminum
53	Coated black (RAL9011)
60	Coated with a silver satin finish (RAL9006)
90	Coated with a black textured matte finish (RAL9011)

Swivel arms

Bright chrome-plated
Coated black or black with textured matte finish
Coated black
Coated with a silver satin finish
Coated with a black textured matte finish (RAL9011)

Cantilever chair

Round steel tubing base frame or aluminum oval tubing base frame

51	Bright chrome-plated
53	Coated black (RAL9011)
60	Coated with a silver satin finish (RAL9006)
90	Coated with a black textured matte finish (RAL9011)

Small components

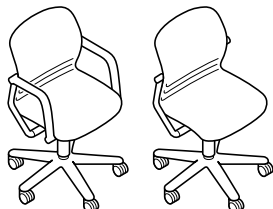
Casters and glides, frame parts, armrests, adjustment levers

41	Black
----	-------



Standard height backrest

■ 88/99 ■ 63 ■ 60
■ 42/53 ■ 49 ■ 45



211/8

Upholstered unitary seat and backrest shell,
precision-adjustable height,
synchro-adjustment, tension control
Aluminum coated frame

Additional charge/reduced prices

Height-adjustable lumbar support

Polished aluminum frame
Bright chrome-plated aluminum frame

Electrically conductive casters

Without armrests

54 60 65 66 92

SEK SEK SEK

10059 10637 11456

735 735 735

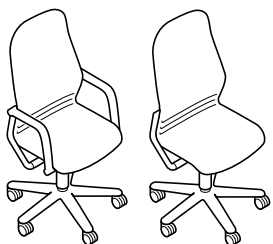
578 578 578
1155 1155 1155

515 515 515

-903 -903 -903

High backrest

■ 105/116 ■ 63 ■ 62
■ 42/53 ■ 49 ■ 45



213/8

Upholstered unitary seat and backrest shell,
precision-adjustable height,
synchro-adjustment, tension control
Aluminum coated frame

Additional charge/reduced prices

Height-adjustable lumbar support

Polished aluminum frame
Bright chrome-plated aluminum frame

Electrically conductive casters

Without armrests

54 60 65 66 92

SEK SEK SEK

11676 12254 13073

735 735 735

578 578 578
1155 1155 1155

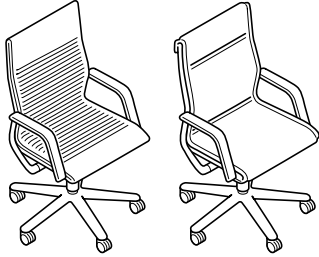
515 515 515

-903 -903 -903



High backrest

108/118 H 67 H 63
42/52 H 55 H 45



220/9

Unitary seat and backrest frame, fully upholstered, with stitched fluting, precision-adjustable height, automatic synchro-adjustment, tension control Aluminum coated frame

Additional charge/reduced prices

With flat cushioning, not available in fabric 69
** Leather 87 only available with flat cushioning

Polished aluminum frame
Bright chrome-plated aluminum frame

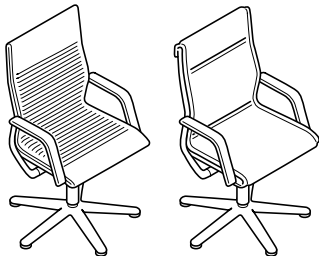
Electrically conductive casters

60
64
65
66
68
91
92
74
87

SEK	SEK	SEK	SEK
32991	34052	42084	42084**
2888	4190	3665	9219
578	578	578	578
1155	1155	1155	1155
515	515	515	515

High backrest

108 H 67 H 63
42 H 55 H 45



220/7

Swivel-mounted, fully upholstered unitary seat and backrest frame, with stitched fluting, automatic synchro-adjustment, tension control Aluminum coated frame

Additional charge/reduced prices

With flat cushioning, not available in fabric 69
** Leather 87 only available with flat cushioning

Polished aluminum frame
Bright chrome-plated aluminum frame

60
64
65
66
68
91
92
74
87

SEK	SEK	SEK	SEK
31878	32939	40971	40971**
2888	4190	3665	9219
578	578	578	578
1155	1155	1155	1155

All task chairs have casters for soft flooring (e. g. carpets). Please order with soft casters (at no extra charge) for hard flooring (e. g. stone, parquet) Electrically conductive casters available for an extra charge.

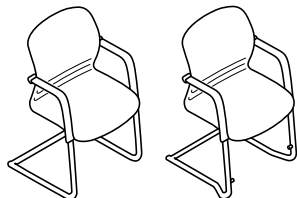
All visitor, conference and cantilever chairs have glides for soft flooring (e. g. carpets). For hard floorings (e. g. stone) please order with soft glides, for wooden floorings (e. g. parquet) please order with extra felt glides (at no extra charge in each case).



	54	60 65 66	92
	SEK	SEK	SEK
	6416	6993	7812
	420	420	420
	1313	1313	1313

Standard height backrest

85 56 61
44



212/5

Upholstered unitary seat and backrest shell
Coated frame

Additional charge/reduced prices

Bright chrome-plated frame
Bright chrome-plated stackable version, up to 5 stackable free-standing, up to 8 on a four-wheeled trolley

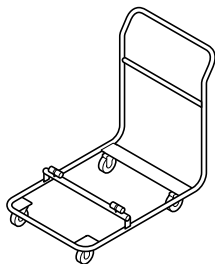
Four-wheeled trolley

277

for 6 stackable cantilever chairs

SEK

6920



21 Range FS Management

Design: Klaus Franck, Werner Sauer, wiege



Technical details

Function

Task chair with automatic synchro-adjustment: The seat and backrest tilt adapt automatically to any posture the user adopts. When leaning back, the backrest tension increases proportionately. The person using the chair can adjust the tension precisely. The front position is lockable by engaging the lever. DIN 4550 compliant gas lift for precision-adjustable seat height.

Frame

Die-cast aluminum, bright chrome-plated star base. Twin-wheel swivel casters with load-dependent braking, made of black polyamide compliant with DIN EN 12529 as the standard version for carpets; with gray soft polyurethane facing for hard floors. Casters optionally electrically conductive. Black polyamide glides as the standard version for carpets and in black polyurethane for hard floorings. Die-cast aluminum, bright chrome-plated swivel arms.

Seat and backrest

Tubular steel frame with a flexible middle section, covered with elastic mesh. Foam upholstery with additional cushioning. Replaceable cover with wider stitched fluting. Integral foam armrests, leather-covered with stitched seam.

Standards

FS-Line task chairs are compliant with the DIN EN 1335 type C office-chair and ANSI/BIFMA X5.1 standards. The FS-Line task chairs comply with the "Ergonomics Approved" standard.



www.tuv.com
ID 1000000000



Please note:

The prices for types with cushioning that includes fabrics and leather provided by the customer are given on request.

Task chairs and armchairs

Star base and swivel arms

51 Bright chrome-plated

Small components

Castors and glides, frame parts, armrests, adjustment levers

41 Black



Medium-height backrest

W 100/110 H 67 H 63
D 42/52 W 55 W 45



220/82

Fully upholstered unitary seat and backrest frame with wider stitched fluting
precision-adjustable height
automatic synchro-adjustment, tension control
Bright chrome-plated aluminum frame

Additional charge/reduced prices

Electrically conductive casters

74

SEK

32697

515

High backrest

W 116/126 H 67 H 63
D 42/52 W 55 W 45



220/92

Fully upholstered unitary seat and backrest frame with wider stitched fluting
precision-adjustable height
automatic synchro-adjustment, tension control
Bright chrome-plated aluminum frame

Additional charge/reduced prices

Electrically conductive casters

74

SEK

37905

515

222 Range Occo

Design: jehs+laub



Technical details

Function

Occo offers superior comfort, enormous versatility and a vast range of design options in a distinctive design language. It's ideal for conference rooms, open-plan meeting areas, cafés, co-working spaces or in homes.

Frame

Four-leg frame models 221/10, 221/11, 221/12, 222/10, 222/11, 222/12

Tubular steel frame, stackable (except for model 222/12), with a textured matte finish coated white, black, gray, gray-beige, emerald green, sienna red or bright chrome-plated. Up to 10 versions without upholstery can be stacked, and 8 with padding on the seat and on the inside. Please note: The leather-cover version is not stackable. Stacking versions with coated frames can cause color to rub off, which is not covered by our guarantee. We recommend chrome-plated frames for this purpose.

Models 221/10 and 222/10 (shell without upholstery) with four separators made of PUR and frame cover made of plastic (PP), each in dark gray. Remove the optional felt pad before stacking because permanent pressure marks can otherwise occur.

Models 221/11, 221/12, 222/11 and 222/12 with stacking guard made of plastic (PP) in dark gray. Tubular steel frame, stackable (except for model 222/12), with a textured matte finish coated white, black, gray, gray-beige, emerald green,

sienna red or bright chrome-plated. Up to 10 versions without upholstery can be stacked, and 8 with padding on the seat and on the inside. Please note: The leather-cover version is not stackable. Stacking versions with coated frames can cause color to rub off, which is not covered by our guarantee. We recommend chrome-plated frames for this purpose.

Solid wood four-leg frame models 221/20, 221/21, 221/22, 222/20, 222/21, 222/22

Seat bearer made of tubular steel in dark gray with a textured matte finish to fit onto the seat shell and to attach the four legs made of solid oak with a natural oiled finish.

Sled (skid) base, models 221/100, 221/101, 221/102 und 222/100, 222/101, 222/102

Sled (skid) base made of steel rod, 12 mm in diameter, coated with a textured matte finish in white, black, gray, gray-beige, emerald green or sienna red or bright chrome plated. Coated frames as a standard and, if required bright chrome-plated frames optionally come with multipurpose glides made of black polyamide. Models 221/100, 221/101 and 221/102 optionally with inline connectors made of black through-dyed poly-

amide including multipurpose glides, optionally with extra felt inserts for flooring that easily scratches (e.g. stone, parquet).

Four-star base models 221/30, 221/31, 221/32, 222/30, 222/31, 222/32, five-star base models 221/40, 221/41, 221/42, 222/40, 222/41, 222/42

Butted tubular steel frame with a textured matte finish coated in white, black, gray, gray-beige, emerald green, sienna red or bright chrome-plated with seat bearer made of molded flat steel in dark gray with a textured matte finish to attach to the shell. In the case of four-star base frames, the steel glides are in dark gray with a textured matte finish.

Four-leg and four-star base models are fitted with multipurpose glides for soft and hard floorings. For sensitive flooring, please order with extra felt glides (at no additional charge).

Five-star base models 221/40, 221/41, 221/42, 222/40, 222/41, 222/42 with twin-wheel swivel casters, load-dependent braking, made of black polypropylene compliant with DIN EN 12529 as the standard version for carpets, optionally with gray tire made of polyurethane for hard flooring.

Four-leg chair and star base

Base frames

51	Bright chrome-plated
85	Coated gray with a textured matte finish (Pantone Cool Gray 10 C)
86	Coated gray-beige with a textured matte finish (Pantone 7530 C)
90	Coated with a black textured matte finish (RAL9011)
91	Coated white with a textured matte finish (RAL9016)
94	Coated emerald green with a textured matte finish (Pantone 5477 C)
95	Coated sienna red with a textured matte finish (Pantone 3523 C)

Five-star base

Star base

Gas lift

Casters Mechanism

51	Bright chrome-plated	Bright chrome-plated or coated black	Black	High-luster polished aluminum
79	Matte-polished aluminum	Bright chrome-plated or coated black	Black	Matte-polished aluminum
90	Coated with a black textured matte finish (RAL9011)	Coated black	Black	High-luster polished aluminum
91	Coated white with a textured matte finish (RAL9016)	Bright chrome-plated or coated black	Black	High-luster polished aluminum

Counter

Star base

Gas lift

Casters

50	Plastic	Black	Black
52	Polished aluminum	Black	Black
72	High-luster polished aluminum	Black	Black
90	Coated with a black textured matte finish (RAL9011)	Black	Black
91	Coated white with a textured matte finish (RAL9016)	Black	Black



Five-star base models 221/00, 221/01, 221/02, 222/00, 222/01, 222/02

Five-star base made of die-cast aluminum with a textured matte finish, coated in white or black, matte polished or with bright chrome plating, with swivel-mounted gas lift column and a lever allows the height to be precision adjusted, seat bearer made of molded flat steel in dark gray, optionally with active rocking technology, can be locked in a horizontal neutral 0 position, with a die-cast aluminum housing, matte polished or high-luster polished. Compliant with DIN EN 1335 and ANSI/BIFMA X 5.1 with twin-wheel swivel casters with load-dependent braking made of black polyamide compliant with DIN EN 12529, as the standard version for carpets; with gray polyurethane tyre for hard flooring.

Counter stool base frame models 221/50, 221/51, 221/52, 222/50, 222/51, 222/52

Five-star base made of black through-dyed, fiberglass-reinforced polyamide, optionally of die-cast aluminum, coated, polished or high-luster polished, with multipurpose twin-wheel swivel casters with load-dependent braking. Swivel-mounted, black gas lift, precision-adjustable with a black lever, with a height-adjustable, bright chrome-plated foot ring and lock screw to keep it in place. Seat bearer made of molded flat steel in dark gray.

Sled (skid) base bar stools, models 223/10, 223/11

Sled (skid) base, stackable when not upholstered, with steel rod footrest, 12 mm diameter, with a textured matte finish coated in white, black, gray, gray-beige, emerald green, sienna red or bright chrome-plated. Please note: Stacking versions with coa-

ted frames can cause color to rub off, which is not covered by our guarantee. We recommend chrome-plated frames for this purpose.

Height-adjustable bar stools with a column foot, models 223/90, 223/91

Brushed, stainless steel disc base, swivel-mounted column with encapsulated gas lift and precision-adjustable height, brushed stainless steel footrest and lever. Seat bearer made of molded flat steel in dark gray.

Solid wood four-leg frame bar stools, models 223/20, 223/21

Seat bearer made of tubular steel in dark gray with a textured matte finish to fit onto the seat shell and to attach the four legs made of solid oak with a natural oiled finish. With steel rod footrest, bright chrome-plated

Seat and backrest

Unitary, ergonomically molded seat shell with cut-out section, made of reinforced through-dyed polypropylene optionally in white, black, gray, gray-beige, emerald green or sienna red. Models without upholstery optionally with a felt seat cushion with non-slip coating. In a light mottled hue, anthracite, graphite, mango, verde, deep water.

All upholstery in models with seat upholstery or padding on the inside is made of cut foam.

Standards

The Occo multipurpose chairs with four-leg frames comply with the DIN EN 16139-L1 office-chair standard.

Meets the DIN EN 16139 office-chair standard, can be stacked: 222/10 four-leg frame, without upholstery up to 10 stackable, 222/11 four-leg frame, with seat cushioning, up to 6 stackable, 222/12 four-leg frame, with padding on the inside, up to 4 stackable.



www.tuv.com
ID 1000000000

Please note

To ensure quality is maintained, we don't offer white leather (74/72). All other standard leather colors are possible.

When exposed to ultra violet rays for long periods of time, the colors of plastics can change slightly. Due to the nature of the material, there are slight differences in the color between white table tops with bonded surfaces and HPL table tops and the white Occo plastic chairs.

Felt is a natural product. Therefore, there can be differences in the color. These differences are not a justified reason for complaint but underscore the material's uniqueness.

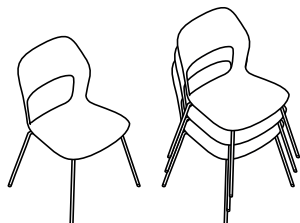
All chairs are fitted with multipurpose glides for soft and hard floorings, in the case of sensitive floorings please order with extra felt glides (at no additional charge).

Five-star base frames are fitted with casters for soft floorings. Please order with soft casters (at no additional charge) for hard flooring (e.g. stone, parquet)



Multipurpose chair

■ 83 ■ 55 ■ 53
■ 44



221/10

Four-leg frame, without upholstery, up to 10 stackable free-standing
Coated frame, color-matched with the shell
Bright chrome-plated frame

SEK

2667
2667

Accessories

186 Four-wheeled trolley
for 6 multipurpose chairs

4011

222 Felt cushion
with non-slip coating, available in 6 colors

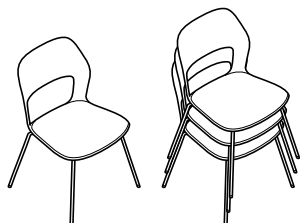
557

Upholstery material

			60			
			64			
			65			
			66			
			68			
	37	51	60	91	74	87
	38	54	66	92		
		58	68			

Multipurpose chair

■ 83 ■ 55 ■ 53
■ 44



221/11

Four-leg frame with seat cushioning, up to
8 stackable free-standing (except with leather
cover)
Coated frame, color-matched with the shell
Bright chrome-plated frame

SEK

3654
3654

SEK

4158
4158

SEK

4347
4347

SEK

4652
4652

SEK

5019
5019

SEK

5765
5765

Accessories

186 Four-wheeled trolley
for 6 multipurpose chairs

4011

4011

4011

4011

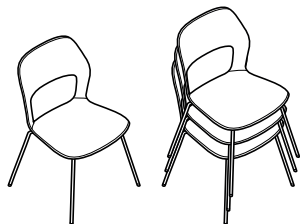
4011

4011

			60			
			64			
			65			
			66			
			68			
	37	51	60	91	74	87
	38	54	66	92		
		58	68			

Multipurpose chair

■ 83 ■ 55 ■ 53
■ 44



221/12

Four-leg frame with padding on the inside, up to
8 stackable free-standing (except with leather
cover)
Coated frame, color-matched with the shell
Bright chrome-plated frame

SEK

5628
5628

SEK

6500
6500

SEK

6773
6773

SEK

7245
7245

SEK

8873
8873

SEK

11120
11120

Accessories

186 Four-wheeled trolley
for 6 multipurpose chairs

4011

4011

4011

4011

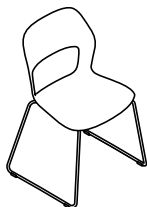
4011

4011



Multipurpose chair

83 55 53
44



221/100

Sled (skid) base, stackable when not upholstered
Coated base frame, color-matched with the shell, with multipurpose glides (optionally with felt insert)
Bright chrome-plated aluminum frame

SEK

2667

2667

Additional charge/reduced prices

Multipurpose glides for bright chrome-plated frame (optionally with felt insert) 158

Accessories

186 Four-wheeled trolley for 6 multipurpose chairs 4011

222 Felt cushion with non-slip coating, available in 6 colors 557

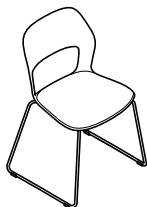
238 Inline connector 452

Upholstery material

			60 64 65 66 68			
	37 38	51 54 58		91 92	74	87

Multipurpose chair

83 55 53
44



221/101

Sled base with seat cushioning, up to 6 stackable free-standing (except with leather cover)
Coated base frame, color-matched with the shell, with multipurpose glides (optionally with felt insert)
Bright chrome-plated aluminum frame

SEK

3654 4158 4347 4652 5019 5765

3654 4158 4347 4652 5019 5765

Additional charge/reduced prices

Multipurpose glides for bright chrome-plated frame (optionally with felt insert) 158

Accessories

186 Four-wheeled trolley for 6 multipurpose chairs 4011

238 Inline connector 452

			64 65 66 68			
	37 38	51 54 58		91 92	74	87

Multipurpose chair

83 55
44



221/102

Sled base with padding on the inside, up to 6 stackable free-standing (except with leather cover)
Coated base frame, color-matched with the shell, with multipurpose glides (optionally with felt insert)
Bright chrome-plated aluminum frame

SEK

5628 6500 6773 7245 8873 11120

5628 6500 6773 7245 8873 11120

Additional charge/reduced prices

Multipurpose glides for bright chrome-plated frame (optionally with felt insert) 158

Accessories

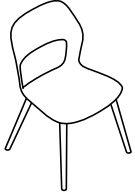
186 Four-wheeled trolley for 6 multipurpose chairs 4011

238 Inline connector 452



Multipurpose chair

83 54 56
44



221/20

Solid oak four-leg frame with a natural oiled finish
not upholstered
not stackable

SEK

4641

Accessories

222 Felt cushion
with non-slip coating, available in 6 colors

557

Upholstery material

			60		
			64		
			65		
			66	91	
			68	92	74
	37	51			
	38	54			
		58			
SEK	SEK	SEK	SEK	SEK	SEK
5628	6132	6321	6626	6993	7739

Multipurpose chair

83 54 56
44



221/21

Solid oak four-leg frame with a natural oiled finish
with seat cushioning
not stackable

SEK

SEK

SEK

SEK

SEK

SEK

5628

6132

6321

6626

6993

7739

			60		
			64		
			65		
			66	91	
			68	92	74
	37	51			
	38	54			
		58			
SEK	SEK	SEK	SEK	SEK	SEK
7602	8474	8747	9219	10847	13094

Multipurpose chair

83 54 56
44



221/22

Solid oak four-leg frame with a natural oiled finish
with padding on the inside
not stackable

SEK

SEK

SEK

SEK

SEK

SEK

7602

8474

8747

9219

10847

13094



Visitor chair

83 51 53
44



221/30

Four-star base frame on glides, swivel-mounted
Coated frame, color-matched with the shell
Bright chrome-plated frame

SEK

5471

5471

Accessories

222 Felt cushion
with non-slip coating, available in 6 colors

557

Upholstery material

		60			
		64			
		65			
		66	91		
		68	92	74	
37	51				
38	54				
	58				
					87

Visitor chair

83 51 53
44



221/31

Four-star base frame on glides, with seat
cushioning, swivel-mounted
Coated frame, color-matched with the shell
Bright chrome-plated frame

SEK

6458

6458

SEK

6962

6962

SEK

7151

7151

SEK

7455

7455

SEK

7823

7823

SEK

8568

8568

		60			
		64			
		65			
		66	91		
		68	92	74	
37	51				
38	54				
	58				
					87

Visitor chair

83 51 53
44



221/32

Four-star base frame on glides, with padding on
the inside, swivel-mounted
Coated frame, color-matched with the shell
Bright chrome-plated frame

SEK

8432

8432

SEK

9303

9303

SEK

9576

9576

SEK

10049

10049

SEK

11676

11676

SEK

13923

13923



Height-adjustable task chair

80/91 H65 H62
39/51



221/00

Five-star base, not upholstered
on casters, precision-adjustable height
Aluminum coated frame
Matte-polished aluminum frame
Bright chrome-plated aluminum frame

Accessories

222 Felt cushion
with non-slip coating, available in 6 colors

SEK

4316
4715
5786

557

Upholstery material

			60			
			64			
			65			
			66	91		
37	51	5996	68	92	74	87
38	58	6300				

Height-adjustable task chair

80/91 H65 H62
39/51



221/01

Five-star base, with seat cushioning
on casters, precision-adjustable height
Aluminum coated frame
Matte-polished aluminum frame
Bright chrome-plated aluminum frame

Additional charge/reduced prices

Active rocking mechanism

SEK	SEK	SEK	SEK	SEK	SEK
5303	5807	5996	6300	6668	7413
5702	6206	6395	6699	7067	7812
6773	7277	7466	7770	8138	8883
504	504	504	504	504	504

			60			
			64			
			65			
			66	91		
37	51	5996	68	92	74	87
38	58	6300				

Height-adjustable task chair

80/91 H65 H62
39/51



221/02

Five-star base, with padding on the inside
on casters, precision-adjustable height
Aluminum coated frame
Matte-polished aluminum frame
Bright chrome-plated aluminum frame

Additional charge/reduced prices

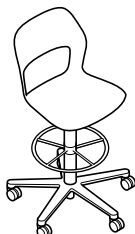
Active rocking mechanism

SEK	SEK	SEK	SEK	SEK	SEK
7277	8148	8421	8894	10521	12768
7676	8547	8820	9293	10920	13167
8747	9618	9891	10364	11991	14238
504	504	504	504	504	504



Counter stool

▣ 96/121 ▣ 67 ▣ 64
▣ 55/80



221/50

Five-star base, not upholstered on casters, precision adjustable height, with foot ring, bright chrome-plated (precision-adjustable height)
Plastic star base
Coated aluminum star base
Polished aluminum star base
High-luster polished aluminum frame

SEK

6311
6972
7361
7497

Accessories

222 Felt cushion with non-slip coating, available in 6 colors

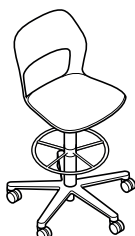
557

Upholstery material

			60		
			64		
			65		
			66	91	
	37	51	66	92	
	38	54	68		74
		58			87

Counter stool

▣ 96/121 ▣ 67 ▣ 64
▣ 55/80



221/51

Five-star base, with seat cushioning, on casters, precision adjustable height, with foot ring, bright chrome-plated (precision-adjustable height)
Plastic star base
Coated aluminum star base
Polished aluminum star base
High-luster polished aluminum frame

SEK

SEK

SEK

SEK

SEK

SEK

SEK

SEK

SEK

SEK

SEK

SEK

SEK

SEK

SEK

SEK

SEK

SEK

SEK

SEK

SEK

SEK

SEK

SEK

SEK

SEK

SEK

SEK

SEK

SEK

SEK

SEK

SEK

SEK

SEK

SEK

SEK

SEK

SEK

SEK

SEK

SEK

SEK

SEK

SEK

SEK

SEK

SEK

SEK

SEK

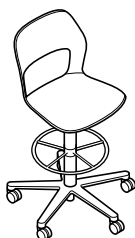
SEK

SEK

SEK

Counter stool

▣ 96/121 ▣ 67 ▣ 64
▣ 55/80



221/52

Five-star base, with padding on the inside, on casters, precision adjustable height, with foot ring, bright chrome-plated (precision-adjustable height)
Plastic star base
Coated aluminum star base
Polished aluminum star base
High-luster polished aluminum frame

SEK

SEK

SEK

SEK

SEK

SEK

SEK

SEK

SEK

SEK

SEK

SEK

SEK

SEK

SEK

SEK

SEK

SEK

SEK

SEK

SEK

SEK

SEK

SEK

SEK

SEK

SEK

SEK

SEK



Task chair

83 66 63
44



221/40

Five-star base frame, not upholstered
on casters, swivel-mounted
Coated frame, color-matched with the shell
Bright chrome-plated frame

SEK

5607
5607

Accessories

222 Felt cushion
with non-slip coating, available in 6 colors

557

Upholstery material

			60		
			64		
			65		
			66	91	
			68	92	74
	37	51			
	38	54			
		58			
					87
SEK	SEK	SEK	SEK	SEK	SEK
6594	7098	7287	7592	7959	8705
6594	7098	7287	7592	7959	8705

Task chair

83 66 63
44



221/41

Five-star base frame
on casters, with seat cushioning, swivel-mounted
Coated frame, color-matched with the shell
Bright chrome-plated frame

			60		
			64		
			65		
			66	91	
			68	92	74
	37	51			
	38	54			
		58			
					87
SEK	SEK	SEK	SEK	SEK	SEK
8568	9440	9713	10185	11813	14060
8568	9440	9713	10185	11813	14060

Task chair

83 66 63
44



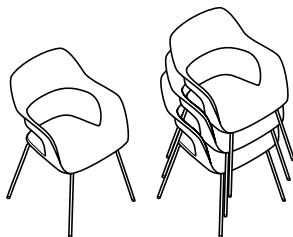
221/42

Five-star base frame
on casters, with padding on the inside, swivel-mounted
Coated frame, color-matched with the shell
Bright chrome-plated frame



Multipurpose chair

83 57 58
44



222/10

Four-leg frame, not upholstered, up to 10 stackable free-standing
Coated frame, color-matched with the shell
Bright chrome-plated frame

SEK

2667
2667

Accessories

186 Four-wheeled trolley
for 6 multipurpose chairs

4011

222 Felt cushion
with non-slip coating, available in 6 colors

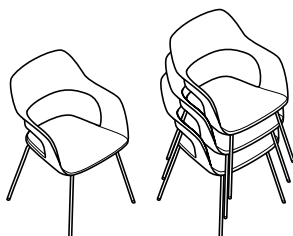
557

Upholstery material

			60			
			64			
			65			
			66	91		
	37		68	92	74	
	38					87

Multipurpose chair

83 57 58
44



222/11

Four-leg frame with seat cushioning, up to
6 stackable free-standing (except with leather
cover)

Coated frame, color-matched with the shell
Bright chrome-plated frame

SEK

3654
3654

SEK

4158
4158

SEK

4347
4347

SEK

4652
4652

SEK

5019
5019

SEK

5765
5765

Accessories

186 Four-wheeled trolley
for 6 multipurpose chairs

4011

4011

4011

4011

4011

4011

			60			
			64			
			65			
			66	91		
	37		68	92	74	
	38					87

Multipurpose chair

83 57 58
44



222/12

Four-leg frame with padding on the inside
Coated frame, color-matched with the shell, not
stackable

Bright chrome-plated frame, not stackable

SEK

5628
5628

SEK

6500
6500

SEK

6773
6773

SEK

7245
7245

SEK

8873
8873

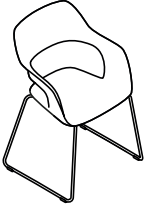
SEK

11120
11120



Multipurpose chair

83 57 54
44



222/100

Sled (skid) base, without upholstery

Coated base frame, color-matched with the shell, with multipurpose glides (optionally with felt insert)

Bright chrome-plated aluminum frame

SEK

2667

2667

Additional charge/reduced prices

Multipurpose glides for bright chrome-plated frame (optionally with felt insert)

158

Accessories

222 Felt cushion

with non-slip coating, available in 6 colors

557

Upholstery material

Multipurpose chair

83 57 54
44



222/101

Sled (skid) base, with seat cushioning

Coated base frame, color-matched with the shell, with multipurpose glides (optionally with felt insert)

Bright chrome-plated aluminum frame

37
38

51
54
58

60
64
65
66
68

91
92

74

87

SEK

SEK

SEK

SEK

SEK

SEK

3654
3654

4158
4158

4347
4347

4652
4652

5019
5019

5765
5765

Additional charge/reduced prices

Multipurpose glides for bright chrome-plated frame (optionally with felt insert)

158

158

158

158

158

158

Multipurpose chair

83 57 54
44



222/102

Sled (skid) base, with padding on the inside

Coated base frame, color-matched with the shell, with multipurpose glides (optionally with felt insert)

Bright chrome-plated aluminum frame

SEK

SEK

SEK

SEK

SEK

SEK

5628
5628

6500
6500

6773
6773

7245
7245

8873
8873

11120
11120

Additional charge/reduced prices

Multipurpose glides for bright chrome-plated frame (optionally with felt insert)

158

158

158

158

158

158



Multipurpose chair

83 57 55
44



222/20

Solid oak four-leg frame with a natural oiled finish
not upholstered
not stackable

SEK

4641

Accessories

222 Felt cushion
with non-slip coating, available in 6 colors

557

Upholstery material

			60		
			64		
			65		
			66	91	
			68	92	74
	37	51			
	38	54			
		58			
SEK	SEK	SEK	SEK	SEK	SEK
5628	6132	6321	6626	6993	7739

Multipurpose chair

83 57 55
44



222/21

Solid oak four-leg frame with a natural oiled finish
with seat cushioning
not stackable

			60		
			64		
			65		
			66	91	
			68	92	74
	37	51			
	38	54			
		58			
SEK	SEK	SEK	SEK	SEK	SEK
7602	8474	8747	9219	10847	13094

Multipurpose chair

83 57 55
44



222/22

Solid oak four-leg frame with a natural oiled finish
with padding on the inside
not stackable



Task chair

83 66 65
44



222/40

Five-star base frame, not upholstered on casters, swivel-mounted
Coated frame, color-matched with the shell
Bright chrome-plated frame

SEK

5607
5607

Accessories

222 Felt cushion with non-slip coating, available in 6 colors

557

Upholstery material

			60		
			64		
			65		
			66	91	
			68	92	74
37	51	60	91	74	87
38	54	64	92		
	58	65			
		66			
		68			
SEK	SEK	SEK	SEK	SEK	SEK
6594	7098	7287	7592	7959	8705
6594	7098	7287	7592	7959	8705

Task chair

83 66 65
44



222/41

Five-star base frame on casters, with seat cushioning, swivel-mounted
Coated frame, color-matched with the shell
Bright chrome-plated frame

			60		
			64		
			65		
			66	91	
			68	92	74
37	51	60	91	74	87
38	54	64	92		
	58	65			
		66			
		68			
SEK	SEK	SEK	SEK	SEK	SEK
8568	9440	9713	10185	11813	14060
8568	9440	9713	10185	11813	14060

Task chair

83 66 65
44



222/42

Five-star base frame on casters, with padding on the inside, swivel-mounted
Coated frame, color-matched with the shell
Bright chrome-plated frame



Height-adjustable task chair

80/91 H65 H62
39/51



222/00

Five-star base, not upholstered
on casters, precision-adjustable height
Aluminum coated frame
Matte-polished aluminum frame
Bright chrome-plated aluminum frame

SEK

4316
4715
5786

Accessories

222 Felt cushion
with non-slip coating, available in 6 colors

557

Upholstery material

			60			
			64			
			65			
			66	91		
	37	51	68	92	74	87
	38	58				

Height-adjustable task chair

80/91 H65 H62
39/51



222/01

Five-star base, with padding on the inside
on casters, precision-adjustable height
Aluminum coated frame
Matte-polished aluminum frame
Bright chrome-plated aluminum frame

SEK

5303
5702
6773

SEK

5807
6206
7277

SEK

5996
6395
7466

SEK

6300
6699
7770

SEK

6668
7067
8138

SEK

7413
7812
8883

Additional charge/reduced prices

Active rocking mechanism

504

504

504

504

504

504

			60			
			64			
			65			
			66	91		
	37	51	68	92	74	87
	38	58				

Height-adjustable task chair

80/91 H65 H62
39/51



222/02

Five-star base, with padding on the inside
on casters, precision-adjustable height
Aluminum coated frame
Matte-polished aluminum frame
Bright chrome-plated aluminum frame

SEK

7277
7676
8747

SEK

8148
8547
9618

SEK

8421
8820
9891

SEK

8894
9293
10364

SEK

10521
10920
11991

SEK

12768
13167
14238

Additional charge/reduced prices

Active rocking mechanism

504

504

504

504

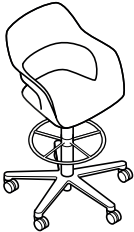
504

504



Counter stool

▣ 96/121 ▣ H 67 ▣ 64
▣ 55/80



222/50

Five-star base, not upholstered on casters, precision adjustable height, with foot ring, bright chrome-plated (precision-adjustable height)
Plastic star base
Coated aluminum star base
Polished aluminum star base
High-luster polished aluminum frame

SEK

6311
6972
7361
7497

Accessories

222 Felt cushion with non-slip coating, available in 6 colors

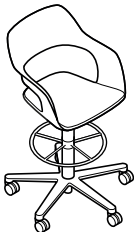
557

Upholstery material

			60			
			64			
			65			
	37	51	66	91		
	38	54	68	92	74	87
		58				

Counter stool

▣ 96/121 ▣ H 67 ▣ 64
▣ 55/80



222/51

Five-star base, with seat cushioning, on casters, precision adjustable height, with foot ring, bright chrome-plated (precision-adjustable height)
Plastic star base
Coated aluminum star base
Polished aluminum star base
High-luster polished aluminum frame

SEK

7298
7959
8348
8484

SEK

7802
8463
8852
8988

SEK

7991
8652
9041
9177

SEK

8295
8957
9345
9482

SEK

8663
9324
9713
9849

SEK

9408
10070
10458
10595

			60			
			64			
			65			
	37	51	66	91		
	38	54	68	92	74	87
		58				

Counter stool

▣ 96/121 ▣ H 67 ▣ 64
▣ 55/80



222/52

Five-star base, with padding on the inside, on casters, precision adjustable height, with foot ring, bright chrome-plated (precision-adjustable height)
Plastic star base
Coated aluminum star base
Polished aluminum star base
High-luster polished aluminum frame

SEK

9272
9933
10322
10458

SEK

10143
10805
11193
11330

SEK

10416
11078
11466
11603

SEK

10889
11550
11939
12075

SEK

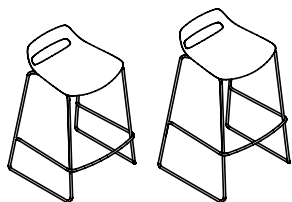
12516
13178
13566
13703

SEK

14763
15425
15813
15950



Bar stool
H 77/87 H 53/54 H 51/52

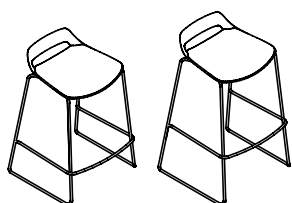


223/10		SEK
Skid (sled) base, without upholstery, up to 10 stackable free-standing, seating height 65 cm		
Coated frame, color-matched with the shell		3161
Bright chrome-plated frame		3161
Skid (sled) base, without upholstery, up to 10 stackable free-standing, seating height 75 cm		
Coated frame, color-matched with the shell		3161
Bright chrome-plated frame		3161
Accessories		
223 Bar stool felt cushion with non-slip coating, available in 6 colors		557

Upholstery material

			60			
			64			
			65			
	37		66	91		
	38		68	92		
					74	
						87
	SEK	SEK	SEK	SEK	SEK	SEK
	4148	4652	4841	5145	5513	6258
	4148	4652	4841	5145	5513	6258
	4148	4652	4841	5145	5513	6258
	4148	4652	4841	5145	5513	6258

Bar stool
H 77/87 H 53/54 H 51/52



223/11						
Skid (sled) base with seat cushioning, not stackable, seating height 65 cm						
Coated frame, color-matched with the shell						
Bright chrome-plated frame						
Skid (sled) base with seat cushioning, not stackable, seating height 75 cm						
Coated frame, color-matched with the shell						
Bright chrome-plated frame						

All chairs are fitted with multipurpose glides for soft and hard floorings, in the case of sensitive floorings please order with extra felt glides (at no additional charge).



Bar stool

77/87 49/52 47/49



223/20

Solid oak four-leg frame with a natural oiled finish, not upholstered, **65 cm seating height**

not stackable 5376

Solid oak four-leg frame with a natural oiled finish, not upholstered, **75 cm seating height**

not stackable 5376

Accessories

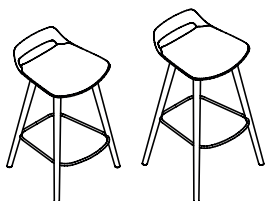
223 Bar stool felt cushion with non-slip coating, available in 6 colors 557

Upholstery material

	Upholstery material					
	37	51	60	91		
	38	54	64	92	74	87
	58	65	66	92		
	68	68				
	SEK	SEK	SEK	SEK	SEK	SEK
	6363	6867	7056	7361	7728	8474
	6363	6867	7056	7361	7728	8474

Bar stool

77/87 49/52 47/49



223/21

Solid oak four-leg frame with a natural oiled finish, with seat cushioning, seating height 65 cm

not stackable 6363 6867 7056 7361 7728 8474

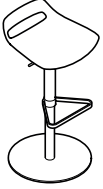
Solid oak four-leg frame with a natural oiled finish, with seat cushioning, seating height 75 cm

not stackable 6363 6867 7056 7361 7728 8474



Height-adjustable bar stool

62/88 45 45
50/76



223/90

Base plate with column, without upholstery
with precision-adjustable height
Brushed stainless steel base frame

SEK

5996

Accessories

223 Bar stool felt cushion
with non-slip coating, available in 6 colors

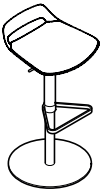
557

Upholstery material

			60		
			64		
			65		
			66	91	
	37	51	68	92	74
	38	58			87
SEK	SEK	SEK	SEK	SEK	SEK
6983	7487	7676	7980	8348	9093

Height-adjustable bar stool

62/88 45 45
50/76



223/91

Base plate with column, with seat cushioning
with precision-adjustable height
Brushed stainless steel base frame

SEK

6983

SEK

7487

SEK

7676

SEK

7980

SEK

8348

SEK

9093



224/225 Range

Occo Conference / Occo Lounge

Design: jehs+laub



Technical details

Function

A versatile chair range in a high-quality design, with six types of frame, two backrest heights, two types of upholstery and a wide range of covers, configurable for all sorts of different areas ranging from lounges where people work, areas in the middle of rooms, workspaces, meeting spaces and conference rooms, as well as company restaurants, bistros and dining rooms, or also lobbies, cozy spaces with fireplaces or TV areas. Excellent ergonomics and superb comfort due to upholstered areas with different levels of firmness. Fully upholstered seat body with integrated armrest pads and a distinctive cut-out section between the seat and the backrest to marry a lightweight appearance with the comforting appeal of a shell chair. With replaceable covers, whose stitching and clamps trace the three-dimensional contours and zones of the upholstered component precisely and in a form-fit way.

Frame

Four-leg frame, steel, models 224/13, 224/14

Tubular steel frame, 18 mm in diameter, with a textured matte finish coated in white or black or with bright chrome plating.

Solid wood four-leg frame, models 224/23, 224/24, 225/23, 225/24

Tubular steel seat bearer in dark gray with a textured matte finish to attach the seat shell and the four tapered legs made of solid oak with a natural oiled finish. In the 225 range lounge models, the seat shell can be tilted backward by 8°.

Sled (skid) base models 224/103, 224/104, 225/103, 225/104

Sled (skid) base made of steel rod, 12 mm diameter, with a textured matte finish, coated in black and white, or with bright chrome plating. Coated frames as a standard and, if required, bright chrome-plated frames optionally with multipurpose glides made of black

polyamide, optionally with additional felt insert. The 225/103 and 225/104 lounge models can be tilted backward by 8°.

Four-star base frame, models 224/33, 224/34

Butted tubular steel frame, with a textured matte finish, coated in white or black or with bright chrome plating, with steel glides in dark gray with a textured matte finish, with multipurpose glides for soft and hard flooring, for sensitive flooring, please order with extra felt glides (at no additional charge).

Five-star base frame, models 224/43, 224/44

Butted tubular steel frame, with a textured matte finish, coated in white or black or with bright chrome plating with twin-wheel swivel casters with load-dependent braking, made of black polyamide, compliant with DIN EN 12529 as the standard version for carpets, optionally available with gray polyurethane tire for hard flooring.

Four-star base, models 224/53, 224/54, 225/53, 225/54

Four-star base made of die-cast aluminum with a textured matte finish, coated white or black, matte polished or with bright chrome plating, with a swivel-mounted stainless steel column (optionally with swivel-return mechanism), in the 225 range lounge models, the seat shell can be tilted 8° backward.

Models 224 with active rocking technology, a lever locks it in a horizontal 0 position, with die-cast aluminum, matte-polished body. Black, multipurpose glides made of plastic for all types of flooring. Optionally with base glides with a larger contact area for sensitive floorings, either to match the star base with a textured matte finish, coated white or black, matte chrome-plated (matte-polished star base) or bright chrome plated (with a bright chrome-plated star base). Black polyamide glides for carpets. For hard floors (e.g. stone), please order with soft TPU, for

Occo Conference four-leg chair and star base

Base frames

51	Bright chrome-plated
90	Coated with a black textured matte finish (RAL9011)
91	Coated white with a textured matte finish (RAL9016)

Four star and five-star base

	Star base	Gas lift	Column	Mechanism	Casters	Base glides
51	Bright chrome-plated	Bright chrome-plated	Stainless steel	Matte-polished aluminum	Black	Bright chrome-plated
79	Matte-polished aluminum	Bright chrome-plated	Stainless steel	Matte-polished aluminum	Black	Matte chrome-plated
90	Coated with a black textured matte finish (RAL9011)	Coated black	Stainless steel	Matte-polished aluminum	Black	Coated with a black textured matte finish (RAL9011)
91	Coated white with a textured matte finish (RAL9016)	Bright chrome-plated	Stainless steel	Matte-polished aluminum	Black	Coated white with a textured matte finish (RAL9016)

Occo Lounge four-star base

	Star base	Column	Base glides
51	Bright chrome-plated	Stainless steel	Bright chrome-plated
79	Matte-polished aluminum	Stainless steel	Matte chrome-plated
90	Coated with a black textured matte finish (RAL9011)	Stainless steel	Coated with a black textured matte finish (RAL9011)
91	Coated white with a textured matte finish (RAL9016)	Stainless steel	Coated white with a textured matte finish (RAL9016)



wooden floors (e. g. parquet) with additional felt. These glides change the models' sitting height from 224 to 44 cm.

Models 224 optionally, compliant with DIN EN 1335 and ANSI/BIFMA X 5.1, with twin-wheel swivel casters with load-dependent braking made of black polyamide compliant with DIN EN 12529, as the standard version for carpets, with gray polyurethane tire for hard flooring. The casters change the seating height to 45 cm.

Five-star base, models 224/63, 224/64

Five-star base made of die-cast aluminum with a textured matte finish, coated in white or black, matte polished or with bright chrome plating, with swivel-mounted gas lift column and active rocking technology, a lever allows the height to be precision adjusted and locked in a horizontal neutral 0 position, with a die-cast aluminum housing, matte polished. Compliant with DIN EN 1335 and ANSI/BIFMA X 5.1 with twin-wheel swivel casters with load-dependent braking made of black polyamide compliant with DIN EN 12529, as the standard version for carpets; with gray polyurethane tyre for hard flooring.

Seat and backrest

Unitary seat shell with integrated armrests and backrest shell, each made of molded plywood, fully padded and covered with PUR molded foam, in different levels of firmness depending on the are upholstered. Seat and backrest shell joined with concealed screws. Covers with contour-creating stitching in the seat and backrest, fixed to the upholstery with clamps, replaceable. Optional seat or seat and backrest with exceptionally soft, looser-fit upholstery (not available in fabric 54, 68 and 91) which is achieved by using more material and less tautness in the covers.

Information

For quality management reasons, we don't offer white leather (74/72). All other standard leather colors are possible.

The nature of looser-fit upholstery means that it creases more and therefore doesn't constitute grounds for complaint.



		38	51 54	60 64 65 68	91 92	74	87
Standard height backrest H93 H66 H64 H44	224/13 Four-leg frame Fully upholstered seat and backrest shell Coated frame Bright chrome-plated frame	SEK 11592 11592	SEK 12317 12317	SEK 13062 13062	SEK 14333 14333	SEK 18165 18165	SEK 23373 23373
	Additional charge/reduced prices Seat with looser-fit upholstery (not available in fabric 54, 68 and 91)	662	662	662	662	662	662
	Seat and backrest with looser-fit upholstery (not available in fabric 54, 68 and 91)	893	893	893	893	893	893



		38	51 54	60 64 65 68	91 92	74	87
Medium-height backrest H103 H66 H64 H44	224/14 Four-leg frame Fully upholstered seat and backrest shell Coated frame Bright chrome-plated frame	SEK 12411 12411	SEK 13293 13293	SEK 14112 14112	SEK 15456 15456	SEK 19488 19488	SEK 24770 24770
	Additional charge/reduced prices Seat with looser-fit upholstery (not available in fabric 54, 68 and 91)	662	662	662	662	662	662
	Seat and backrest with looser-fit upholstery (not available in fabric 54, 68 and 91)	893	893	893	893	893	893

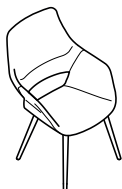


		38	51 54	60 64 65 68	91 92	74	87
Standard height backrest H93 H66 H64 H44	224/23 Solid oak four-leg frame with a natural oiled finish Fully upholstered seat and backrest shell	SEK 13545	SEK 14270	SEK 15015	SEK 16286	SEK 20118	SEK 25326
	Additional charge/reduced prices Seat with looser-fit upholstery (not available in fabric 54, 68 and 91)	662	662	662	662	662	662
	Seat and backrest with looser-fit upholstery (not available in fabric 54, 68 and 91)	893	893	893	893	893	893





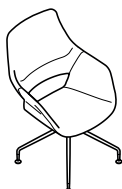
		38	51 54	60 64 65 68	91 92	74	87
Medium-height backrest H103 H66 H64 H44	224/24 Solid oak four-leg frame with a natural oiled finish Fully upholstered seat and backrest shell	SEK 14364	SEK 15246	SEK 16065	SEK 17409	SEK 21441	SEK 26723
	Additional charge/reduced prices Seat with looser-fit upholstery (not available in fabric 54, 68 and 91)	662	662	662	662	662	662
	Seat and backrest with looser-fit upholstery (not available in fabric 54, 68 and 91)	893	893	893	893	893	893



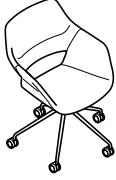
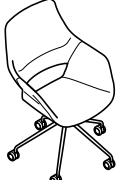

		38	51 54	60 64 65 68	91 92	74	87
Standard height backrest H93 H66 H63 H44	224/33 Swivel-mounted four-star base frame Fully upholstered seat and backrest shell Coated frame Bright chrome-plated frame	SEK 15971 15971	SEK 16695 16695	SEK 17441 17441	SEK 18711 18711	SEK 22544 22544	SEK 27752 27752
	Additional charge/reduced prices Seat with looser-fit upholstery (not available in fabric 54, 68 and 91)	662	662	662	662	662	662
	Seat and backrest with looser-fit upholstery (not available in fabric 54, 68 and 91)	893	893	893	893	893	893



		38	51 54	60 64 65 68	91 92	74	87
Medium-height backrest H103 H66 H63 H44	224/34 Swivel-mounted four-star base frame Fully upholstered seat and backrest shell Coated frame Bright chrome-plated frame	SEK 16790 16790	SEK 17672 17672	SEK 18491 18491	SEK 19835 19835	SEK 23867 23867	SEK 29148 29148
	Additional charge/reduced prices Seat with looser-fit upholstery (not available in fabric 54, 68 and 91)	662	662	662	662	662	662
	Seat and backrest with looser-fit upholstery (not available in fabric 54, 68 and 91)	893	893	893	893	893	893



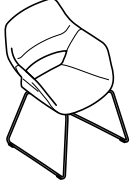


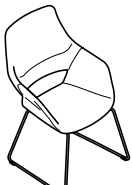
		38	51 54	60 64 65 68	91 92	74	87
Standard height backrest H93 H66 H63 H44	224/43 Swivel-mounted five-star base frame on casters Fully upholstered seat and backrest shell Coated frame Bright chrome-plated frame	SEK 16307 16307	SEK 17031 17031	SEK 17777 17777	SEK 19047 19047	SEK 22880 22880	SEK 28088 28088
	Additional charge/reduced prices Seat with looser-fit upholstery (not available in fabric 54, 68 and 91) Seat and backrest with looser-fit upholstery (not available in fabric 54, 68 and 91)	662 893	662 893	662 893	662 893	662 893	662 893
Medium-height backrest H103 H66 H63 H44	224/44 Swivel-mounted five-star base frame on casters Fully upholstered seat and backrest shell Coated frame Bright chrome-plated frame	SEK 17126 17126	SEK 18008 18008	SEK 18827 18827	SEK 20171 20171	SEK 24203 24203	SEK 29484 29484
	Additional charge/reduced prices Seat with looser-fit upholstery (not available in fabric 54, 68 and 91) Seat and backrest with looser-fit upholstery (not available in fabric 54, 68 and 91)	662 893	662 893	662 893	662 893	662 893	662 893
Standard height backrest H92 H66 H63 H43	224/53 Swivel-mounted, aluminum four-star base Active rocking mechanism Aluminum coated frame Matte polished aluminum frame Bright chrome-plated aluminum frame	SEK 14133 14532 15603	SEK 14858 15257 16328	SEK 15603 16002 17073	SEK 16874 17273 18344	SEK 20706 21105 22176	SEK 25914 26313 27384
	Additional charge/reduced prices Swivel-return mechanism Base glides Casters Seat with looser-fit upholstery (not available in fabric 54, 68 and 91) Seat and backrest with looser-fit upholstery (not available in fabric 54, 68 and 91)	1523 651 609 662 893	1523 651 609 662 893	1523 651 609 662 893	1523 651 609 662 893	1523 651 609 662 893	1523 651 609 662 893



		38	51 54	60 64 65 68	91 92	74	87	
Medium-height backrest H102 H66 H63 H43		SEK	SEK	SEK	SEK	SEK	SEK	
	224/54							
	Aluminum four star base, Active rocking mechanism	14952	15834	16653	17997	22029	27311	
	Aluminum coated frame	15351	16233	17052	18396	22428	27710	
	Matte polished aluminum frame	16422	17304	18123	19467	23499	28781	
	Bright chrome-plated aluminum frame							
	Additional charge/reduced prices							
	Swivel-return mechanism	1523	1523	1523	1523	1523	1523	
	Base glides	651	651	651	651	651	651	
	Casters	609	609	609	609	609	609	
	Seat with looser-fit upholstery (not available in fabric 54, 68 and 91)	662	662	662	662	662	662	
Seat and backrest with looser-fit upholstery (not available in fabric 54, 68 and 91)	893	893	893	893	893	893		
Standard height backrest H88/98 H66 H63 H39/49		SEK	SEK	SEK	SEK	SEK	SEK	
	224/63							
	Aluminum five-star base on casters precision-adjustable height rocking mechanism	14543	15267	16013	17283	21116	26324	
	Aluminum coated frame	14942	15666	16412	17682	21515	26723	
	Matte polished aluminum frame	16013	16737	17483	18753	22586	27794	
	Bright chrome-plated aluminum frame							
	Additional charge/reduced prices							
	Seat with looser-fit upholstery (not available in fabric 54, 68 and 91)	662	662	662	662	662	662	
	Seat and backrest with looser-fit upholstery (not available in fabric 54, 68 and 91)	893	893	893	893	893	893	
	Medium-height backrest H98/108 H66 H63 H39/49		SEK	SEK	SEK	SEK	SEK	SEK
		224/64						
Aluminum five-star base on casters precision-adjustable height rocking mechanism		15362	16244	17063	18407	22439	27720	
Aluminum coated frame		15761	16643	17462	18806	22838	28119	
Matte polished aluminum frame		16832	17714	18533	19877	23909	29190	
Bright chrome-plated aluminum frame								
Additional charge/reduced prices								
Seat with looser-fit upholstery (not available in fabric 54, 68 and 91)		662	662	662	662	662	662	
Seat and backrest with looser-fit upholstery (not available in fabric 54, 68 and 91)		893	893	893	893	893	893	



		38	51 54	60 64 65 68	91 92	74	87
Standard height backrest	224/103	SEK	SEK	SEK	SEK	SEK	SEK
 ■ 93 ■ 66 ■ 64 ■ 44	Sled (skid) base Fully upholstered seat and backrest shell Coated frame, with multipurpose glides (optionally with felt insert) Bright chrome-plated frame	11592 11592	12317 12317	13062 13062	14333 14333	18165 18165	23373 23373
	Additional charge/reduced prices						
	Multipurpose glides for bright chrome-plated frame (optionally with felt insert)	158	158	158	158	158	158
	Seat and backrest with looser-fit upholstery (not available in fabric 54, 68 and 91)	893	893	893	893	893	893

		38	51 54	60 64 65 68	91 92	74	87
Medium-height backrest	224/104	SEK	SEK	SEK	SEK	SEK	SEK
 ■ 103 ■ 66 ■ 64 ■ 44	Sled (skid) base Fully upholstered seat and backrest shell Coated frame, with multipurpose glides (optionally with felt insert) Bright chrome-plated frame	12411 12411	13293 13293	14112 14112	15456 15456	19488 19488	24770 24770
	Additional charge/reduced prices						
	Multipurpose glides for bright chrome-plated frame (optionally with felt insert)	158	158	158	158	158	158
	Seat and backrest with looser-fit upholstery (not available in fabric 54, 68 and 91)	893	893	893	893	893	893



		38	51 54	60 64 65 68	91 92	74	87
--	--	----	----------	----------------------	----------	----	----

Standard height backrest

80 66 68
41



225/23

Solid oak four-leg frame with a natural oiled finish lounge version
Fully upholstered seat and backrest shell

Additional charge/reduced prices

Seat and backrest with looser-fit upholstery (not available in fabric 54, 68 and 91)

SEK	SEK	SEK	SEK	SEK	SEK
13545	14270	15015	16286	20118	25326
893	893	893	893	893	893

		38	51 54	60 64 65 68	91 92	74	87
--	--	----	----------	----------------------	----------	----	----

Medium-height backrest

90 66 68
41



225/24

Solid oak four-leg frame with a natural oiled finish lounge version
Fully upholstered seat and backrest shell

Additional charge/reduced prices

Seat and backrest with looser-fit upholstery (not available in fabric 54, 68 and 91)

SEK	SEK	SEK	SEK	SEK	SEK
14364	15246	16065	17409	21441	26723
893	893	893	893	893	893

		38	51 54	60 64 65 68	91 92	74	87
--	--	----	----------	----------------------	----------	----	----

Standard height backrest

80 66 68
40



225/53


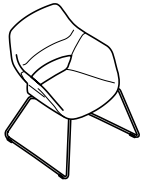
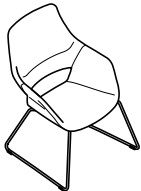
Four-star base made of die-cast aluminum, swivel-mounted
Lounge version
Fully upholstered seat and backrest shell
Aluminum coated frame
Matte-polished aluminum frame
Bright chrome-plated aluminum frame

Additional charge/reduced prices

Seat and backrest with looser-fit upholstery (not available in fabric 54, 68 and 91)
Swivel-return mechanism
Base glides

SEK	SEK	SEK	SEK	SEK	SEK
13986	14711	15456	16727	20559	25767
14385	15110	15855	17126	20958	26166
15456	16181	16926	18197	22029	27237
893	893	893	893	893	893
1523	1523	1523	1523	1523	1523
651	651	651	651	651	651



		38	51 54	60 64 65 68	91 92	74	87
Medium-height backrest H 90 H 66 H 71 W 40	225/54 Four-star base made of die-cast aluminum, swivel-mounted Lounge version Fully upholstered seat and backrest shell Aluminum coated frame Matte-polished aluminum frame Bright chrome-plated aluminum frame	SEK 14805 15204 16275	SEK 15687 16086 17157	SEK 16506 16905 17976	SEK 17850 18249 19320	SEK 21882 22281 23352	SEK 27164 27563 28634
	Additional charge/reduced prices Seat and backrest with looser-fit upholstery (not available in fabric 54, 68 and 91) Swivel-return mechanism Base glides	893 1523 651	893 1523 651	893 1523 651	893 1523 651	893 1523 651	893 1523 651
Standard height backrest H 80 H 66 H 68 W 37	225/103 Sled (skid) base lounge version Fully upholstered seat and backrest shell Coated aluminum frame, with multipurpose glides (optionally with felt insert) Bright chrome-plated frame	SEK 11592 11592	SEK 12317 12317	SEK 13062 13062	SEK 14333 14333	SEK 18165 18165	SEK 23373 23373
	Additional charge/reduced prices Multipurpose glides for bright chrome-plated frame (optionally with felt insert) Seat and backrest with looser-fit upholstery (not available in fabric 54, 68 and 91)	158 893	158 893	158 893	158 893	158 893	158 893
Medium-height backrest H 89 H 66 H 68 W 37	225/104 Sled (skid) base lounge version Fully upholstered seat and backrest shell Sled (skid) base lounge version Fully upholstered seat and backrest shell Bright chrome-plated frame	SEK 12411 12411	SEK 13293 13293	SEK 14112 14112	SEK 15456 15456	SEK 19488 19488	SEK 24770 24770
	Additional charge/reduced prices Multipurpose glides for bright chrome-plated frame (optionally with felt insert) Seat and backrest with looser-fit upholstery (not available in fabric 54, 68 and 91)	158 893	158 893	158 893	158 893	158 893	158 893



Programm 222

Occo

Design: jehs+laub



Further information
Occo Tables

Technical details

Tables

Frame

Models 222/60 and 222/70 with four star-base table legs

Made of butted tubular steel, optionally coated with a textured matte finish in black or white or bright chrome plating.

Models 222/61, 222/71, 222/81, 222/91

With a four-leg frame, solid oak, with a natural oiled finish.

Models 222/61 and 222/71

In standing height with a horizontal stretcher made of bright chrome-plated round steel. With multipurpose glides for soft and hard floorings. In the case of wooden floorings (e.g. parquet) please order with extra felt glides (at no additional charge).

Models 222/62 and 222/72

Side-table height with a four-star base made of die-cast aluminum with a textured matte finish, coated in white or black, matte-polished or with bright chrome plating, with a table column complete with textured matte finish in black or coated white when the star base is white. Black, multipurpose glides made of plastic for all types of flooring.

Model 222/73

In side-table height with a three-star base made of flat steel and table column made of tubular steel, coated white or black with a textured matte finish, with round steel flange, coated black. Multipurpose glides made of black polypropylene

Models 222/80 and 222/90

Table legs are connected by a crossbeam. Models as of 90 x 180 cm include an extra reinforcement underframe in dark gray with a textured matte finish.

All table top bearers and glides made of steel in dark gray with a textured matte finish.

With multipurpose glides for soft and hard floorings. In the case of wooden floorings (e.g. parquet) please order with extra felt glides (at no extra charge). Adjustment range: 10 mm.

Optional lockable, height-adjustable, swivel casters with a black polyamide tire as the standard version for carpets; with a polyurethane tire for hard floors (please specify when ordering).

Models 222/81 and 222/91

In standing height with a center underframe and diagonal stretcher made of bright chrome-plated round steel.

Core panels on table top, table top group 2 – veneer variant 1 and 2

MDF (medium density fiberboard), table top thickness 26 mm

Variant 1:

Beech or oak veneer from the Wilkhahn woodstain color samples with chamfered wood edging, color-matched as far as possible with the veneer. Models 222/61, 222/71, 222/81 and 222/91 only available with oak veneer.

Variant 2:

(only models 222/60, 222/70, 222/80, 222/90) walnut or elm veneer from the Wilkhahn woodstain color samples with chamfered wood edging, color-matched as far as possible with the veneer.

Side-table heights that can be ordered: 46 cm and 51 cm, table height 74 cm, standing height 106 cm



E2 – 5 chamfered wood lipping, 12 mm

Table top group 5 – with bonded surface

Table top thickness 25 mm thick, with a bonded melamine resin surface in white or black with straight plastic edging, color matched with the surface.

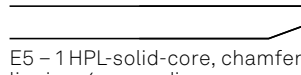
Heights that can be ordered: 46 cm and 51 cm, table height 74 cm, standing height 106 cm



E2 – 3 straight plastic lipping

Table top group 7 - black/white through-dyed

Table top thickness 12 mm, made of through-dyed HPL (High Pressure Laminate) in black or white, with chamfered edging. Side-table heights that can be ordered: 45 cm and 50 cm, table height 73 cm, standing height 105 cm



E5 – 1 HPL-solid-core, chamfered lipping, 4 mm radius

Table top group 10 – solid wood

Table top thickness 25 mm, solid oak from the Wilkhahn woodstain color samples, natural oiled finish, edging, rounded on

the bottom.

Heights that can be ordered: 46 cm and 51 cm, table height 74 cm, standing height 106 cm



E4 – 1 solid wood, rounded on the bottom

Information

Due to the nature of the material, there are slight differences in the color between white table tops with bonded surfaces and HPL table tops and the white Occo plastic chairs.

Tables

Base frame

- 51 Bright chrome-plated
- 90 Coated with a black textured matte finish (RAL9011)
- 91 Coated white with a textured matte finish (RAL9016)

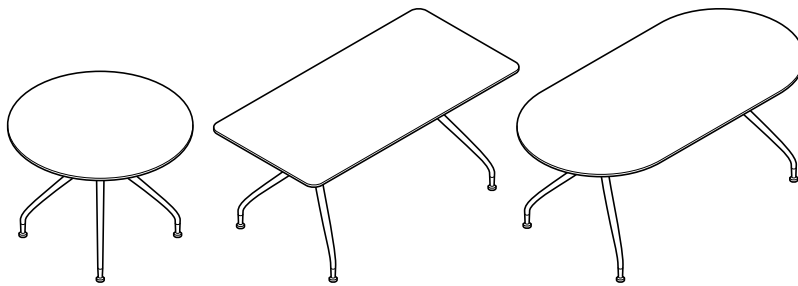
Lounge tables (except model 222/73)

Base frame

- 51 Bright chrome-plated
- 79 Matte-polished aluminum
- 90 Coated with a black textured matte finish (RAL9011)
- 91 Coated white with a textured matte finish (RAL9016)

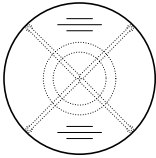
Column

- Coated with a black textured matte finish (RAL9011)
- Coated with a black textured matte finish (RAL9011)
- Coated with a black textured matte finish (RAL9011)
- Coated white with a textured matte finish (RAL9016)



	5	7	7	2	2	10
Direct coating						
		Black through-dyed	White through-dyed	Veneer variant 1	Veneer variant 2	Solid wood
SEK	SEK	SEK	SEK	SEK	SEK	SEK

Round



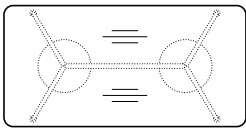
222/70
 Ø100
 For 4 people
 Coated frame
 Bright chrome-plated frame

10647	12632	13860	16821	18396	22701
12002	13986	15215	18176	19751	24056

Additional charge/reduced prices
 Casters

294	294	294	294	294	294
-----	-----	-----	-----	-----	-----

Rectangular



222/80
 80 x 160
 For 4-6 people
 Coated frame
 Bright chrome-plated frame

14060	16359	17882	21746	23678	31973
15761	18060	19583	23447	25379	33674

90 x 180
 For 6 people
 Coated frame
 Bright chrome-plated frame

15005	17567	19478	23877	26376	38808
16706	19268	21179	25578	28077	40509

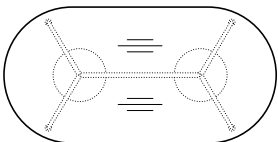
90 x 190
 For 6 people
 Coated frame
 Bright chrome-plated frame

15288	18060	20108	24843	27542	40562
16989	19761	21809	26544	29243	42263

Additional charge/reduced prices
 Casters

294	294	294	294	294	294
-----	-----	-----	-----	-----	-----

Oval



222/90
 90 x 180
 For 6 people
 Coated frame
 Bright chrome-plated frame

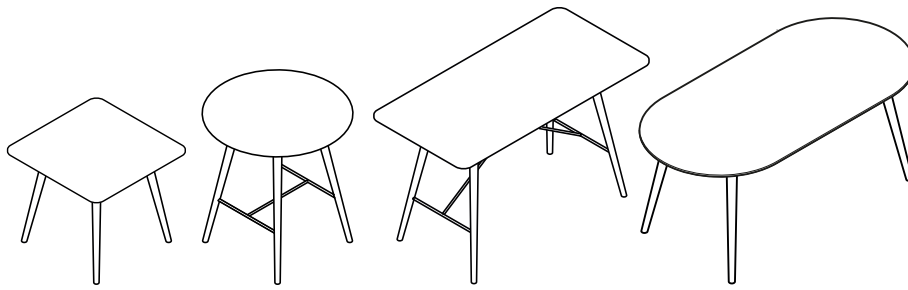
15005	17567	19478	23877	26376	38808
16706	19268	21179	25578	28077	40509

90 x 200
 For 6 people
 Coated frame
 Bright chrome-plated frame

15572	18554	20738	25872	28770	42347
17273	20255	22439	27573	30471	44048

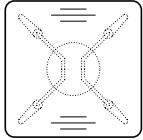
Additional charge/reduced prices
 Casters

294	294	294	294	294	294
-----	-----	-----	-----	-----	-----



5	7	7	2	10
Direct coating	Black through-dyed	White through-dyed	Veneer variant 1	Solid wood
SEK	SEK	SEK	SEK	SEK

Square



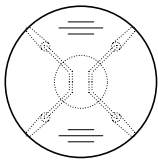
222/61
90 x 90
For 4 people
Solid oak four-leg frame with a natural oiled finish

12726 14711 15782 18827 24665

Additional charge/reduced prices
High table height

4809 4809 4809 4809 4809

Round



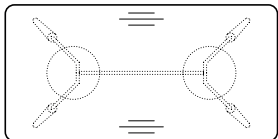
222/71
Ø 100
For 4 people
Solid oak four-leg frame with a natural oiled finish

12779 14763 15992 18953 24707

Additional charge/reduced prices
High table height

4809 4809 4809 4809 4809

Rectangular



222/81
80 x 160
For 4-6 people
Solid oak four-leg frame with a natural oiled finish

16170 18470 19992 23856 34083

90 x 180
For 6 people
Solid oak four-leg frame with a natural oiled finish

17115 19667 21578 25967 35795

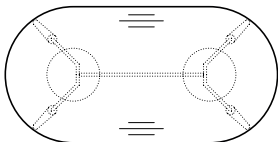
90 x 190
For 6 people
Solid oak four-leg frame with a natural oiled finish

17399 20171 22218 26954 42672

Additional charge/reduced prices
High table height

4809 4809 4809 4809 4809

Oval



222/91
90 x 180
For 6 people
Solid oak four-leg frame with a natural oiled finish

17115 19667 21578 25967 40919

90 x 200
For 6 people
Solid oak four-leg frame with a natural oiled finish

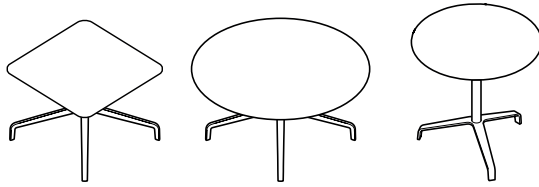
17682 20664 22848 27983 44457

Additional charge/reduced prices
High table height

4809 4809 4809 4809 4809

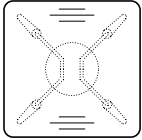
Occo
Lounge tables

Table top group



5	7	7	2	2	10
Direct coating	Black through-dyed	White through-dyed	Veneer variant 1	Veneer variant 2	Solid wood
SEK	SEK	SEK	SEK	SEK	SEK

Square

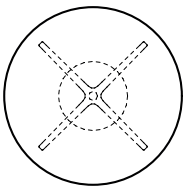


222/62

75 x 75, H 45
Four star base made of die-cast aluminum
Aluminum coated frame
Matte-polished aluminum frame
Bright chrome-plated aluminum frame

7235	8810	9797	12873	14375	17325
7634	9209	10196	13272	14774	17724
8705	10280	11267	14343	15845	18795

Round

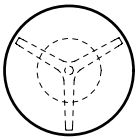


222/72

Ø 90, H 45
Four star base made of die-cast aluminum
Aluminum coated frame
Matte-polished aluminum frame
Bright chrome-plated aluminum frame

10059	11550	12737	15803	17346	20255
10458	11949	13136	16202	17745	20654
11529	13020	14207	17273	18816	21725

Round



222/73

Ø 50, H 50
Three-star base made of steel
Coated frame

6174	7077	7550	10049	11078	13230
------	------	------	-------	-------	-------

227 Range Pep

Design: Wilkhahn



Technical details

Function

A task chair as a visitor chair that combines ergonomic comfort with a clear design language. Areas used: meeting rooms, public service areas and offices at home.

Seat and backrest


Unitary plywood shell fully padded with PUR (CFC-free) with additional padding and covered optionally on all sides with fabric or leather.

Armrests

Armrests in black polyamide.

Standards

The PEP multipurpose chairs comply with the DIN EN 16139-L1 office-chair standard.

		Upholstery material					
		47	51 54	60 64 65 66 68	91 92	74	87
		SEK	SEK	SEK	SEK	SEK	SEK
Multipurpose chair 	227/33 fully upholstered, without armrests, with contact suppression feature, four-star base frame on glides, Aluminum coated frame Polished aluminum frame	7991	8337	8673	9356	10584	13367
		7991	8337	8673	9356	10584	13367
	Additional charge/reduced prices Polyamide armrests Casters	1659 137	1659 137	1659 137	1659 137	1659 137	1659 137

Task chair

Base frame

- 53 Coated black (RAL9011)
- 60 Coated with a silver satin finish (RAL9006)
- 90 Coated with a black textured matte finish (RAL9011)
- 91 Coated white with a textured matte finish (RAL9016)



Programm 230

Aline

Design: Andreas Störiko



Technical details

Function

Stylish and coherently designed, multipurpose furnishing range for meetings, consultations and seminars, in showrooms and event spaces, areas for breaks, lounges and bistros, as well as libraries, Internet cafés or home offices.

Multipurpose chair

Lightweight, transparent and stackable multipurpose chair for meetings, customer service, seminars and settings requiring lots of chairs. Compact and form-fit stacking with just 20 mm more space taken per chair thanks to the self-engaging seat and backrest frames (when 15 chairs are stacked, the total height is just 106 cm). Weight 5.1 kg without armrests or 5.4 kg (with armrests).

Multipurpose chair optionally with seat cushioning, as a stackable or non-stackable version. The stackable versions come with extra stacking bumpers and allow compact and form-fit stacking.

Bar stool

Stylish and transparent bar stool with a backrest and footrest, optionally with seat cushioning.

Task and visitor chairs

Simple, transparent swivel-mounted visitor task chairs and height-adjustable office task chairs for meetings and consultations, Internet cafés, showrooms and hot desking spaces.

Frame

Multipurpose chair

Multipurpose chair: Sled base made of steel rod, 12 mm in diameter, bright chrome-plated, designed as a support for the seat frame at the front, inserted through the seat frame into the backrest frames at the rear. If required, black plastic multipurpose glides for all types of flooring, optionally with additional felt inserts.

When ordering the inline connector model 238, multipurpose glides, optionally with additional felt insert for flooring that easily scratches (e.g. stone, parquet) are automatically applied.

Bar stool

Like the multipurpose chair, but not stackable, additional reinforcement with bright chrome-plated flat-steel stretcher (16 x 6 mm) and steel rod footrest.

Task and visitor chair

Four-star base (visitor chair) or five-star base (task chair) in die-cast aluminum, bright chrome-plated. Task chair with black poly-

amide glides (for soft flooring), or black polyurethane (for hard flooring), optionally with additional felt insert. Task chair with twin-wheel swivel casters in black polypropylene with load-dependent braking (for soft floors) or with a soft tire (for hard floors); anti-static casters on request. Fixed height swivel pedestal with contact suppression feature (visitor chair) swivel-mounted column (task chair) with precision-adjustable height, bright chrome-plated tube.

Seat and backrest

Mod. 230/1, 230/2, 230/5 seat- and backrest frame made of high strength, fiberglass-reinforced polyamide, optionally black, gray oder white through-dyed, covered with high-performance, covered polyester fabric, optionally color-matched with seat- and backrest frame. When the seat- and backrest frame are black through-dyed, optionally with a two-color cover in copper-black or silver-black possible as well. Backrest frame optionally with or without armrests in the same material and color. Optionally with a polypropylene seat shell and cut-foam seat cushioning.

Stackable variants with fiberglass-reinforced polyamide stacking bumper that color-matches the seat and backrest frame.

Task and visitor chairs (models 232/1, 232/2), optionally with seat cushioning made of cut foam, with stitched fluting cover, upholstery thickness 10 mm.

Accessories

Optional for the multipurpose chair: Automatically retractable inline connectors type 231 made of matte chrome-plated steel. Inline connectors, type 238, only with special multipurpose glides made of black POM for hard and soft floorings, or with felt insert for flooring that easily scratches. Chairs with armrests can only be linked alternately with chairs without armrests. Four-wheeled trolley that nests into other trolleys made of black-coated tubular steel with four ball-bearing-mounted wheels for hard and soft floorings, two of which are lockable directional wheels.

Standards

The stackable Aline chairs comply with the DIN EN 16139-L1 and ANSI/BIFMA X 5.1 office-chair standard. Compliant with the DIN EN 16139-L1 office-chair standard, up to 13 multipurpose chairs can be stacked vertically.



www.tuv.com
ID 109000000



Multipurpose and counter chairs

Base frame

51 Bright chrome-plated

Task and visitor chairs

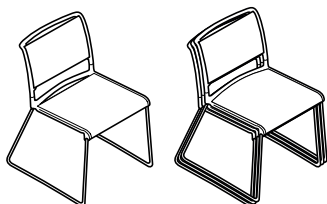
Base frame

51 Bright chrome-plated



Multipurpose chair

78 54 58
44



230/1

Multipurpose chair, up to 15 chairs
stackable free-standing,
covered seat and backrest frame
Bright chrome-plated frame

Additional charge/reduced prices

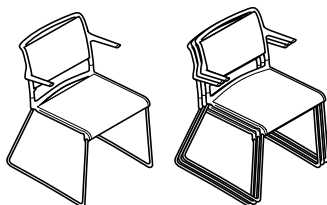
Inline connector
Higher backrest (total height: 80 cm)
Seat cushioning
Seat cushioning, stackable version, up to
10 chairs

Polyester fabric in copper-black or silver-
black (only for black through-dyed seat
and backrest frames)
Multipurpose glides (for soft and hard
floorings)
Multipurpose glides with felt insert

SEK	SEK	SEK	SEK	SEK	SEK
	38	47	54 58	60 66 68	91
4715					
578					
221					
	1050	1323	1470	1638	1901
	1281	1523	1701	1922	2258
305					
95					
158					

Multipurpose chair

78 59 58
44



230/2

With armrests
multipurpose chair, up to 15 chairs
stackable free-standing
covered seat and backrest frame
Bright chrome-plated frame

Additional charge/reduced prices



Inline connector
Higher backrest (total height: 80 cm)
Seat cushioning
Seat cushioning, stackable version, up to
10 chairs

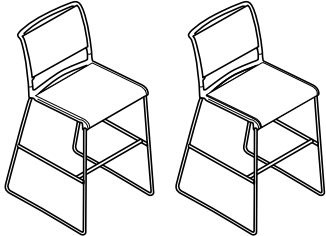
Polyester fabric in copper-black or silver-
black (only for black through-dyed seat
and backrest frames)
Multipurpose glides (for soft and hard
floorings)
Multipurpose glides with felt insert

SEK	SEK	SEK	SEK	SEK	SEK
	38	47	54 58	60 66 68	91
5240					
578					
221					
	1050	1323	1470	1638	1901
	1281	1523	1701	1922	2258
305					
95					
158					

Black plastic multipurpose glides for all types of flooring, for wooden floorings (e. g. parquet) please order with extra felt glides (at no extra charge in each case). On request with black polyamide glides so that the seating can be used on different floorings, optionally with extra felt insert (for flooring that easily scratches like stone or parquet). Stackable chairs with armrests only alternately with stackable chairs without armrests.



Bar stool
 105  54  61
 69



230/5
 Footrest,
 covered seat and backrest frame
 Bright chrome-plated frame

Additional charge/reduced prices
 Seat cushioning

Polyester fabric in copper-black or silver-black (only for black through-dyed seat and backrest frames)
 Multipurpose glides (for soft and hard floorings)
 Multipurpose glides with felt insert

	38	47	54 58	60 66 68	91
SEK	SEK	SEK	SEK	SEK	SEK
6258					
	1050	1323	1470	1638	1901
305					
95					
158					

Black plastic multipurpose glides for all types of flooring, for wooden floorings (e. g. parquet) please order with extra felt glides (at no extra charge in each case). On request with black polyamide glides so that the seating can be used on different floorings, optionally with extra felt insert (for flooring that easily scratches like stone or parquet). Stackable chairs with armrests only alternately with stackable chairs without armrests.



Task chair

76/88 H 65 H 64
40/52



232/1

Covered seat and backrest frame,
precision-adjustable height
Bright chrome-plated frame

SEK

7560

Additional charge/reduced prices

Higher backrest (total height 78/90 cm)
Electrically conductive casters

221

515

Polyester fabric in copper-black or silver-black (only for black through-dyed seat and backrest frames)

305

Seat cushioning with a cover with stitched fluting (only when upholstery material 47 is chosen)

1544

Task chair

76/88 H 65 H 64
40/52



232/2

With armrests
covered seat and backrest frame,
precision-adjustable height
Bright chrome-plated frame

SEK

8085

Additional charge/reduced prices

Higher backrest (total height 78/90 cm)
Electrically conductive casters

221

515

Polyester fabric in copper-black or silver-black (only for black through-dyed seat and backrest frames)

305

Seat cushioning with a cover with stitched fluting (only when upholstery material 47 is chosen)

1544

Inline connector

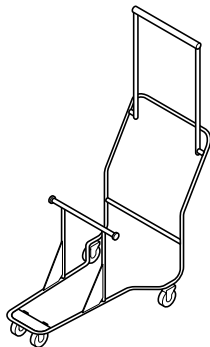


231

(for models 230/1 and 230/2)

578

Four-wheeled trolley



232

for 20 multipurpose chairs without seat cushioning
for 15 multipurpose chairs with seat cushioning

7592

Inline connector



238

Inline connector for skid base, with glides for soft floorings, for assembly with/with, with/without and without/without armrests

452

Inline connector for skid base, with glides with felt insert, for assembly with/with, with/without and without/without armrests

504

All task chairs have casters for soft flooring (e. g. carpets). Please order with soft casters (at no extra charge) for hard flooring (e. g. stone, parquet) All visitor chairs have glides for soft flooring (e. g. carpets). For hard floorings (e. g. stone) please order with soft glides, for wooden floorings (e. g. parquet) please order with extra felt glides (at no extra charge in each case).

230 Range

230 range

Design: Andreas Störiko



Further information

Technical details

Function

Stylish and coherently designed, multipurpose furnishing range for meetings, consultations and seminars, in showrooms and event spaces, areas for breaks, lounges and bistros, as well as libraries, Internet cafés or home offices.

Square and round top pedestal tables in low, sitting and standing heights (optionally stackable) and rectangular tables on a T-shaped base for lounges and recreational areas, cafeterias and bistros.

Tables 235, 236, 237/00, 237/10

Frame

Models 235/236

Four-star base made of die-cast aluminum, bright chrome-plated, with glides made of black polyamide (for soft floorings) or black polyurethane (for hard floorings), optionally with additional felt insert. Table column made of 4-mm-thick tubular steel, 40 mm in diameter, at side-table, sitting and standing height (45/73/105 cm) coated in black or white to match the table top, with round flange made of steel, color-matched with the column, the stackable version comes with extra glide and impact protection, slip-free separator and docking guide each made of black plastic.

Model 237/00 and 237/10

Unitary foot section made of die-cast aluminum, coated white, model 237/00 optionally also coated black or bright chrome-plated. Black polyamide glides (for soft flooring), or black polyurethane (for hard flooring), optionally with additional felt insert. Aluminum upright to match the table top, coated white, model 237/00 or also coated black or optionally bright chrome-plated. Underframes made of rectangular steel tubing with flange, coated black or white depending on the foot section. Coated black in the case of a bright chrome-plated foot section.

Core material of the table top models 235, 236, 237/00

Table top made of through-dyed HPL (High Pressure Laminate) in black or white. Each table top 12 mm thick.

Models 235/236 in sizes: 70 x 70 cm (where table heights are 73 cm) or round, diameter 70 cm (where table height is 105 cm). Models 237 in various formats: (table height 73 cm)

E5 – 1 HPL-solid-core, chamfered lipping, 4 mm radius

Core material of table top models 237/10

Plywood with bonded melamine resin surface with straight, color-matched plastic edging all the way round.

Straight plastic edging

Tables (235/1 – 236/3)

Star base

51 Bright chrome-plated

Table column

Black, black with a textured matte finish, coated white or white with a textured matte finish

Tables (237/00)

Foot section

49 Coated white (RAL9003)
51 Bright chrome-plated
53 Coated black (RAL9011)
90 Coated with a black textured matte finish (RAL9011)
91 Coated white with a textured matte finish (RAL9016)

Upright

Coated white
Coated black or bright chrome-plated
Coated black
Coated with a black textured matte finish (RAL9011)
Coated white with a textured matte finish (RAL9016)

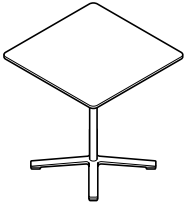
Underframes

Coated white
Coated black
Coated black
Coated with a black textured matte finish (RAL9011)
Coated white with a textured matte finish (RAL9016)



7
Black through-dyed
7
White through-dyed
SEK SEK

Square



235/2

Table 70 x 70, H 73
Bright chrome-plated star base
Coated column

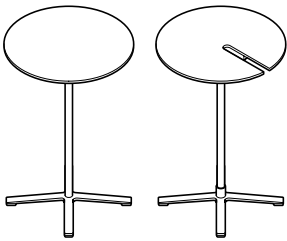
8348 10532

Additional charge/reduced prices

Bright chrome-plated column

557 557

Round



236/3

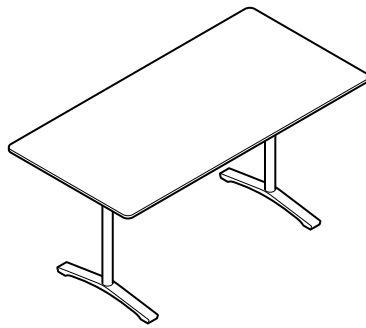
Round high table, Ø 70, H 105
Bright chrome-plated star base
Coated column

8589 10773

Additional charge/reduced prices

Bright chrome-plated column
Stackable version (up to 3 free-standing)

809 809
1691 1691



Rectangular



237/00

e.g. 70 x 140, H 73
coated foot section
Coated uprights and underframes

Additional charge/reduced prices

Bright chrome-plated foot section
Bright chrome-plated upright

SEK

819
1134

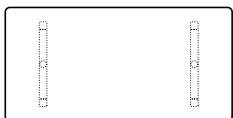
Table top group

	Width	Depth			
		70	75	80	90
7 Black through-dyed	140	12054	-	-	-
	150	-	12086	-	-
	160	-	-	12149	-
	180	-	-	-	13409
	200	-	-	-	13461
7 White through-dyed	140	14847	-	-	-
	150	-	15047	-	-
	160	-	-	15236	-
	180	-	-	-	17378
	200	-	-	-	17588

Direct coating 5

SEK

Rectangular



237/10

75x150
Foot section coated white
Uprights and underframes coated white

7035

- not available

All tables come with glides for soft floorings (e. g. carpets). For hard floorings (e. g. stone) please order with soft glides, for wooden floorings (e. g. parquet) please order with extra felt glides (at no extra charge in each case).



238 Range Aula

Design: Wolfgang C.R. Mezger



Technical details

Function

Lightweight, stackable multipurpose chair. Because of its form, elasticity and ergonomically designed seat shells made of plastic or plywood, Aula is exceptionally comfortable to sit on for long periods of time. Four colors, four types of upholstery and three frame variants tap into a wide range of options for features and designs in conference and multipurpose spaces, meeting areas, cafeterias, seminar and conference centers or co-working spaces.

Frame/armrests

Models 238/10, 238/11, 238/12, 238/13 and 239/10, 239/11, 239/12 with stackable all-plastic frames made of through-dyed, fiberglass-reinforced ultramid, in white, black, gray and gray-beige to match the seat shell, with multipurpose glides, optionally with felt glides, optionally with or without armrests in the same material and color, retrofittable on request.

Models 238/20, 238/21, 238/22 and und 239/20, 239/21, 239/22 with a skid (sled) base made of steel rod

(Ø 12 mm), bright chrome-plated or in a textured matte finish coated white, black, gray and gray-beige (in the case of plastic shells, color-matched as far as possible) with multipurpose glides, optionally with additional felt insert, optionally with or without armrests in the same material and color. PVC-free, tube-shaped armrest pad made of black-gray, thermoplastic elastomer. Armrests not retrofittable.

Please note: Not stackable in the version with a leather cover. Stacking versions with coated frames can cause color to rub off, which is not covered by our guarantee. We recommend chrome-plated frames for this purpose.

Models 238/30, 238/33 and 239/30 - 239/32 with round steel tubing four-leg frames.

(Ø 18 mm), bright chrome-plated or as far as possible color-matched in a textured matte finish and coated in white, black, gray or

gray-beige, with fitted inline connectors made of black, through-dyed fiberglass-reinforced polyamide and multipurpose glides, optionally with additional felt insert, optionally with or without armrests in the same material and color. PVC-free, tube-shaped armrest pad made of black-gray, thermoplastic elastomer. Armrests not retrofittable. Please note: Not stackable in the version with a leather cover. Stacking versions with coated frames can cause color to rub off, which is not covered by our guarantee. We recommend chrome-plated frames for this purpose.

Seat and backrest

Models 238/10 - 238/32

Unitary, ergonomic molded seat shell made of through-dyed, fiberglass-reinforced polypropylene, similarly to the frame and armrests in white, black, gray or gray-beige. Models 238/11, 238/21 and 238/31 with seat cushioning, models 238/12, 238/22 and 238/32 with padding on the inside (=unitary seat and backrest cushioning) each with replaceable upholstery element made of plywood and breathable polyurethane foam.

Model 238/13 and 238/33

with fully upholstered and covered plywood shell with unitary seat and back cushioning made of breathable polyurethane foam.

Models 239/10 - 239/32

Unitary plywood shell with a natural beech veneer, natural oak veneer in a natural color, or oak veneer stained black, each sealed

with a clear fire-safe varnish (DIN 4102 B1). Models 239/11, 239/21 and 239/31 with seat cushioning, models 239/12, 239/22 and 239/32 with padding on the inside (=unitary seat and back cushioning) each with replaceable upholstery element made of plywood and breathable polyurethane foam. Optionally with flame-retardant CMHR foam.

Accessories

Fixed inline connectors to link models with plastic frames (238/10 - 238/13, 239/10 - 239/12), without armrests, made of zinc-plated steel, blue zinc-plated (retrofittable). Adaptable, pull-out inline connectors to link up models with plastic frames (238/10 - 238/13 und 239/10 - 239/12), optionally without armrests, with armrests or in combination with frames with and without armrests, made of bent steel, blue zinc-plated with clip made of fiberglass-reinforced polyamide in anthracite (retrofittable).

Inline connectors when a writing tablet is added on request.

Inline connectors to link models with sled (skid) bases (238/20, 238/21, 238/22, 239/20, 239/21, 239/22), optionally without armrests, with armrests or in combination with frames with and without armrests in black, through-dyed polyamide.

Multipurpose chair plastic frame

Base frame

50 Plastic

Skid (sled) base multipurpose chair

Steel rod frame

51 Bright chrome-plated
90 Coated with a black textured matte finish (RAL9011)
91 Coated white with a textured matte finish (RAL9016)
85 Coated gray with a textured matte finish (Pantone Cool Gray 10 C)
86 Coated gray-beige with a textured matte finish (Pantone 7530 C)

Multipurpose chair four-leg frame

Round steel tubing frame

51 Bright chrome-plated
90 Coated with a black textured matte finish (RAL9011)
91 Coated white with a textured matte finish (RAL9016)
85 Coated gray with a textured matte finish (Pantone Cool Gray 10 C)
86 Coated gray-beige with a textured matte finish (Pantone 7530 C)



Magnetic clip for seat and row numbering made of plastic in anthracite, can optionally be slotted onto the frame on the right or the left, only in conjunction with plastic frames (238/10 - 238/13 und 239/10 - 239/12).

Clips for row numbering when chairs have different frames on request. Number tags with white numbers on anthracite sheet steel.

Writing tablet to slot onto the armrest (only when plastic frames are chosen), can be folded up, table top made of black HPL, plastic linking device in black (retrofitable). Chairs can still be stacked.

Dimensions, weights

238/10 - 238/13 und 239/10 - 239/12

Seating height 45 cm,
total height 81 cm,
width without armrests 55 cm,
with armrests 63 cm,
depth 57 cm,
armrest height 67 cm,
center-to-center distances when chairs are linked in the combination of without/without armrests 55 cm, with/without armrests 60 cm, with/with armrests 64 cm.
Weight (without upholstery):
6 kg without armrests,
6.75 kg with armrests

238/30 - 238/33 and 239/30 - 239/32

Seating height 45 cm,
total height 81 cm,
width without and with armrests 54 cm,
depth 56 cm,
armrest height 67 cm,
center-to-center distances in linkage options of all combinations 56 cm,
weight (without upholstery):
7.15 kg without armrests,
7.46 kg with armrests

238/30, 238/31, 238/32

Seating height 45 cm,
total height 81 cm,
width without armrests 52 cm,
with armrests 56 cm,
depth 56 cm,
armrest height 67 cm.
Center-to-center distances when linked regardless of combinations 51 cm,
weight (without upholstery):
5.5 kg without armrests,
6.1 kg with armrests

Maximum number of chairs that can be stacked:

Maximum number of chairs that can be stacked: 15 free-standing with plastic and tubular steel frames, 10 with a sled (skid) base, 10 on four-wheeled trolleys, height between chairs when stacked: 90

mm with a plastic frame, 37 mm/52 mm with sled (skid) base (not upholstered/upholstered), 55 mm with a tubular steel frame.

Standards

The stackable Aula chairs comply with the DIN EN 16139-L1 and ANSI/BIFMA X 5.1 office-chair standard. Compliant with the DIN EN 16139-L1 office-chair standard, up to 10 multipurpose chairs can be stacked vertically.



www.tuv.com
ID 1000000000



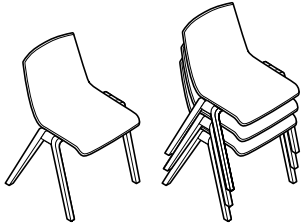
Please note

Stacking the models with plastic frames chairs can cause shine and pressure marks. Stacking models with coated metal frames can cause color to rub off, which is not covered by our guarantee. We recommend chrome-plated frames for this purpose.



Multipurpose chair

81 55 57
45



238/10

Plastic shell
up to 15 stackable free-standing,
up to 10 on a four-wheeled trolley,
Plastic frame

SEK

2688

Additional charge/reduced prices

Polyamide armrests

704

Inline connector, permanent for linking chairs without/without armrest

273

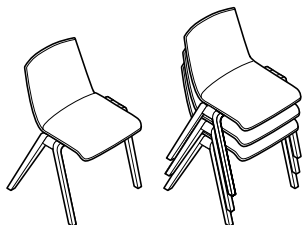
Inline connector, extendable for linking chairs with/with armrest and with/without armrest

473



Multipurpose chair

81 55 57
45



238/11

Plastic shell
with seat cushioning
up to 15 stackable free-standing,
up to 10 on a four-wheeled trolley,
Plastic frame

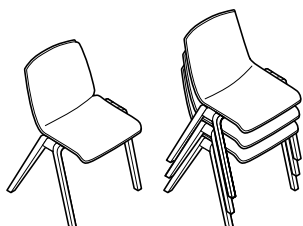
Additional charge/reduced prices

Polyamide armrests
Inline connector, permanent for linking chairs
without/without armrest
Inline connector, extendable for linking chairs
with/with armrest and with/without armrest

			60		
			64		
		51	65		
		54	66	91	
		58	68	92	74
	37				
	38	47			
SEK	SEK	SEK	SEK	SEK	SEK
3686	4053	4190	4389	4694	4767
704	704	704	704	704	704
273	273	273	273	273	273
473	473	473	473	473	473

Multipurpose chair

81 55 57
45



238/12

Plastic shell
with padding on the inside
up to 15 stackable free-standing,
up to 10 on a four-wheeled trolley,
Plastic frame

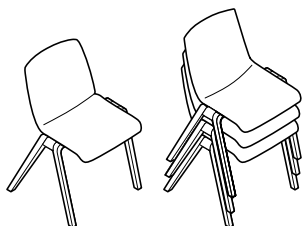
Additional charge/reduced prices

Polyamide armrests
Inline connector, permanent for linking chairs
without/without armrest
Inline connector, extendable for linking chairs
with/with armrest and with/without armrest

			60		
			64		
		51	65		
		54	66	91	
		58	68	92	74
	37				
	38	47			
SEK	SEK	SEK	SEK	SEK	SEK
4809	5681	5943	6216	6479	6636
704	704	704	704	704	704
273	273	273	273	273	273
473	473	473	473	473	473

Multipurpose chair

81 55 57
45



238/13

fully upholstered
up to 15 stackable free-standing,
up to 10 on a four-wheeled trolley,
Plastic frame

Additional charge/reduced prices

Polyamide armrests
Inline connector, permanent for linking chairs
without/without armrest
Inline connector, extendable for linking chairs
with/with armrest and with/without armrest

			60		
			64		
		51	65		
		54	66	91	
		58	68	92	74
	38				
	47				
SEK	SEK	SEK	SEK	SEK	SEK
6794	7665	7928	8201	8463	8621
704	704	704	704	704	704
273	273	273	273	273	273
473	473	473	473	473	473

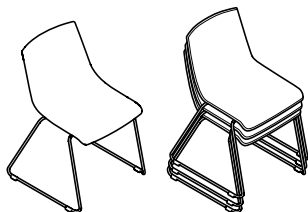
All chairs with plastic frames come with multipurpose glides for soft and hard floorings, please order with extra felt glides (at no extra charge) for sensitive flooring.

Aula
Multipurpose chair



Multipurpose chair

■ 81 ■ 54 ■ 56
■ 45



238/20

Plastic shell
skid (sled) base, up to 10 stackable free-standing or on a four-wheeled trolley
Coated sled (skid) base, with multipurpose glides (optionally with felt insert)
Bright chrome-plated sled (skid) base

SEK

2982

2982

Additional charge/reduced prices

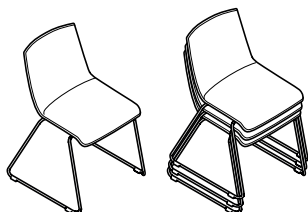
Armrests 704
Multipurpose glides for bright chrome-plated frame for soft and hard flooring, optionally with felt insert 158

Upholstery material

	37		51	60		
	38	47	54	64	91	74
			58	65	92	
			66	68		

Multipurpose chair

■ 81 ■ 54 ■ 56
■ 45



238/21

Plastic shell
with seat cushioning
skid (sled) base, up to 10 stackable free-standing or on a four-wheeled trolley
Coated skid (sled) base, with multipurpose glides (optionally with felt insert)
Bright chrome-plated skid (sled) base

SEK SEK SEK SEK SEK SEK

3980 4347 4484 4683 4988 5061
3980 4347 4484 4683 4988 5061

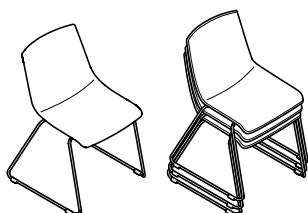
Additional charge/reduced prices

Armrests 704 704 704 704 704 704
Multipurpose glides for bright chrome-plated frame for soft and hard flooring, optionally with felt insert 158 158 158 158 158 158

	37		51	60		
	38	47	54	64	91	74
			58	65	92	
			66	68		

Multipurpose chair

■ 81 ■ 54 ■ 56
■ 45



238/22

Plastic shell
with padding on the inside
skid (sled) base, up to 10 stackable free-standing or on a four-wheeled trolley
Coated skid (sled) base, with multipurpose glides (optionally with felt insert)
Bright chrome-plated skid (sled) base

SEK SEK SEK SEK SEK SEK

5103 5975 6237 6510 6773 6930
5103 5975 6237 6510 6773 6930

Additional charge/reduced prices

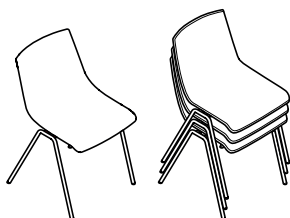
Armrests 704 704 704 704 704 704
Multipurpose glides for bright chrome-plated frame for soft and hard flooring, optionally with felt insert 158 158 158 158 158 158

Skid-base chairs can optionally (for an extra charge) come with multipurpose glides for soft and hard flooring, in the case of sensitive floors please order with extra felt insert (at no extra charge).



Multipurpose chair

81 55 57
45



238/30

Plastic shell
with fitted inline connectors
four-leg frame, up to 15 stackable free-standing and 10 on a four-wheeled trolley
Coated four-leg frame
Bright chrome-plated four-leg frame

SEK

3213

3213

Additional charge/reduced prices

Armrests

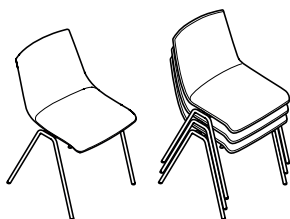
704

Upholstery material

			60		
			64		
			65		
			66	91	
37			68	92	
38	47				74

Multipurpose chair

81 55 57
45



238/31

Plastic shell
with seat cushioning
four-leg frame up to 15 stackable free-standing,
up to 10 on a four-wheeled trolley
with fitted inline connectors
Coated four-leg frame
Bright chrome-plated four-leg frame

SEK SEK SEK SEK SEK SEK

4211 4578 4715 4914 5219 5292
4211 4578 4715 4914 5219 5292

Additional charge/reduced prices

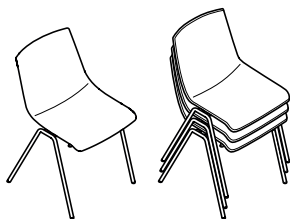
Armrests

704 704 704 704 704 704

			60		
			64		
			65		
			66	91	
37			68	92	
38	47				74

Multipurpose chair

81 55 57
45



238/32

Plastic shell
with padding on the inside
four-leg frame, up to 15 stackable free-standing,
up to 10 on a four-wheeled trolley
with fitted inline connectors
Coated four-leg frame
Bright chrome-plated four-leg frame

SEK SEK SEK SEK SEK SEK

5334 6206 6468 6741 7004 7161
5334 6206 6468 6741 7004 7161

Additional charge/reduced prices

Armrests

704 704 704 704 704 704



Multipurpose chair

81 55 57
45



238/33

Fully upholstered
with fitted inline connectors,
up to 15 stackable free-standing, up to 10 on a
four-wheeled trolley
Coated four-leg frame
Bright chrome-plated four-leg frame

Additional charge/reduced prices

Armrests

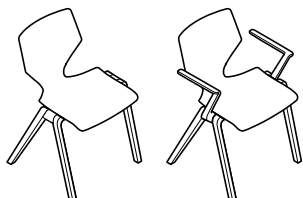
	38	47	51 54 58	60 64 65 66 68	91 92	74
	SEK	SEK	SEK	SEK	SEK	SEK
	7319	8180	8453	8726	8988	9146
	7319	8180	8453	8726	8988	9146
Additional charge/reduced prices						
Armrests	704	704	704	704	704	704

All chairs with four-leg frames have multipurpose glides for soft and hard flooring, in the case of sensitive floors please order with extra felt glides (at no extra charge).



Multipurpose chair

81 55 57
45



239/10

Beech shell, with a natural finish,
up to 15 stackable free-standing,
up to 10 on a four-wheeled trolley
Plastic frame

SEK

3864

Additional charge/reduced prices

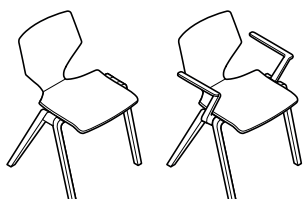
Wooden shell in oak, with a natural finish	368
Wooden shell in oak, varnished in black	368
Polyamide armrests	704
Inline connector, permanent for linking chairs without/without armrest	273
Inline connector, extendable for linking chairs with/with armrest and with/without armrest	473

Upholstery material

			60		
			64		
			65		
			66	91	
37			51	92	
38	47		54		74
			58		
			68		

Multipurpose chair

81 55 57
45



239/11

Beech shell with a natural finish,
with seat cushioning
up to 15 stackable free-standing,
up to 10 on a four-wheeled trolley
Plastic frame

SEK SEK SEK SEK SEK SEK

4862 5229 5366 5565 5870 5943

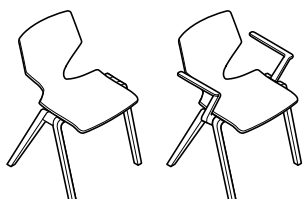
Additional charge/reduced prices

Wooden shell in oak, with a natural finish	368	368	368	368	368	368
Wooden shell in oak, varnished in black	368	368	368	368	368	368
Fire safe variant*	147	147	147	147	147	147
Polyamide armrests	704	704	704	704	704	704
Inline connector, permanent for linking chairs without/without armrest	273	273	273	273	273	273
Inline connector, extendable for linking chairs with/with armrest and with/without armrest	473	473	473	473	473	473

			60		
			64		
			65		
			66	91	
37			51	92	
38	47		54		74
			58		
			68		

Multipurpose chair

81 55 57
45



239/12

Beech shell, with a natural finish,
with padding on the inside
up to 15 stackable free-standing,
up to 10 on a four-wheeled trolley
Plastic frame

SEK SEK SEK SEK SEK SEK

5985 6846 7119 7392 7655 7812

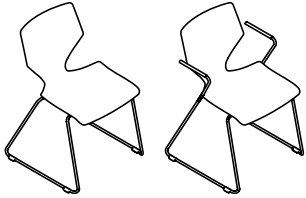
Additional charge/reduced prices

Wooden shell in oak, with a natural finish	368	368	368	368	368	368
Wooden shell in oak, varnished in black	368	368	368	368	368	368
Fire safe variant*	273	273	273	273	273	273
Polyamide armrests	704	704	704	704	704	704
Inline connector, permanent for linking chairs without/without armrest	273	273	273	273	273	273
Inline connector, extendable for linking chairs with/with armrest and with/without armrest	473	473	473	473	473	473



Multipurpose chair

81 54 56
45



239/20

Beech shell, with a natural varnished finish,
sled (skid) base, up to 10 stackable free-standing,
up to 10 on a four-wheeled trolley
Coated sled (skid) base, with multipurpose glides (optionally with felt insert)
Bright chrome-plated sled (skid) base

SEK

4148
4148

Additional charge/reduced prices

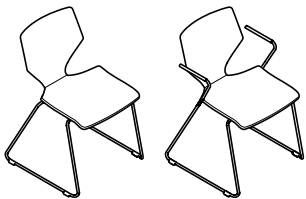
Wooden shell in oak, with a natural finish 368
Wooden shell in oak, varnished in black 368
Armrests 704
Multipurpose glides for bright chrome-plated frame for soft and hard flooring, optionally with felt insert 158

Upholstery material

				60		
			51	64		
			54	65		
37			58	66	91	
38	47		68	68	92	74

Multipurpose chair

81 54 56
45



239/21

Beech shell with a natural varnished finish,
with seat cushioning
sled (skid) base, up to 10 stackable free-standing,
up to 10 on a four-wheeled trolley
Coated sled (skid) base, with multipurpose glides
(optionally with felt insert)
Bright chrome-plated sled (skid) base

SEK SEK SEK SEK SEK SEK

Additional charge/reduced prices

Wooden shell in oak, with a natural finish 368
Wooden shell in oak, varnished in black 368
Fire safe variant* 147
Armrests 704
Multipurpose glides for bright chrome-plated frame for soft and hard flooring, optionally with felt insert 158

5145 5523 5670 5870 6185 6269
5145 5523 5670 5870 6185 6269

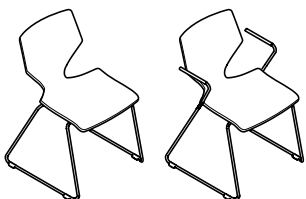
368 368 368 368 368 368
368 368 368 368 368 368
147 147 147 147 147 147
704 704 704 704 704 704

158 158 158 158 158 158

				60		
			51	64		
			54	65		
37			58	66	91	
38	47		68	68	92	74

Multipurpose chair

81 54 56
45



239/22

Beech shell with a natural varnished finish,
with padding on the inside
sled (skid) base, up to 10 stackable free-standing,
or up to 10 on a four-wheeled trolley
Coated sled (skid) base, with multipurpose glides
(optionally with felt insert)
Bright chrome-plated sled (skid) base

SEK SEK SEK SEK SEK SEK

Additional charge/reduced prices

Wooden shell in oak, with a natural finish 368
Wooden shell in oak, varnished in black 368
Fire safe variant* 273
Armrests 704
Multipurpose glides for bright chrome-plated frame for soft and hard flooring, optionally with felt insert 158

6269 7172 7455 7739 7991 8180
6269 7172 7455 7739 7991 8180

368 368 368 368 368 368
368 368 368 368 368 368
273 273 273 273 273 273
704 704 704 704 704 704

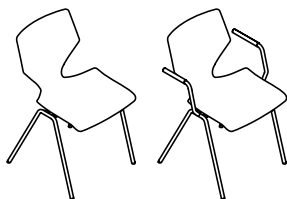
158 158 158 158 158 158

Skid-base chairs can optionally (for an extra charge) come with multipurpose glides for soft and hard flooring, in the case of sensitive floors please order with extra felt insert (at no extra charge).



Multipurpose chair

81 52 56
45



239/30

Beech shell with a natural finish,
with fitted inline connectors
four-leg frame, up to 15 stackable free-standing and 10 on a four-wheeled trolley
Coated four-leg frame
Bright chrome-plated four-leg frame

SEK

4389
4389

Additional charge/reduced prices

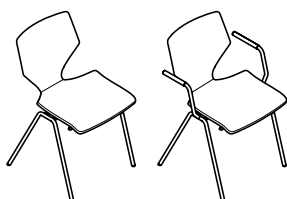
Wooden shell in oak, with a natural finish 368
Wooden shell in oak, varnished in black 368
Armrests 704

Upholstery material

				60		
				64		
				65		
				66	91	
				68	92	74
37						
38	47					

Multipurpose chair

81 52 56
45



239/31

Beech shell, with a natural finish,
four-leg frame up to 15 stackable free-standing,
up to 10 on a four-wheeled trolley
with seat cushioning
with fitted inline connectors
Coated four-leg frame
Bright chrome-plated four-leg frame

SEK SEK SEK SEK SEK SEK

5387 5754 5891 6090 6395 6468
5387 5754 5891 6090 6395 6468

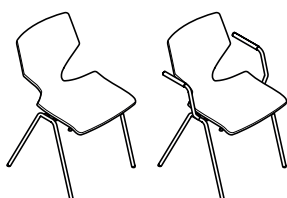
Additional charge/reduced prices

Wooden shell in oak, with a natural finish 368 368 368 368 368 368
Wooden shell in oak, varnished in black 368 368 368 368 368 368
Fire safe variant* 147 147 147 147 147 147
Armrests 704 704 704 704 704 704

				60		
				64		
				65		
				66	91	
				68	92	74
37						
38	47					

Multipurpose chair

81 52 56
45



239/32

Beech shell, with a natural finish,
with padding on the inside
four-leg frame up to 15 stackable free-standing,
up to 10 on a four-wheeled trolley
with fitted inline connectors
Coated four-leg frame
Bright chrome-plated four-leg frame

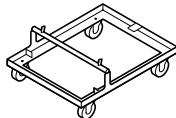








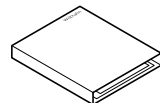
SEK SEK SEK SEK SEK SEK

6510 7371 7644 7917 8180 8337
6510 7371 7644 7917 8180 8337

Additional charge/reduced prices

Wooden shell in oak, with a natural finish 368 368 368 368 368 368
Wooden shell in oak, varnished in black 368 368 368 368 368 368
Fire safe variant* 273 273 273 273 273 273
Armrests 704 704 704 704 704 704



		SEK
Four-wheeled trolley 	186 for 10 multipurpose chairs	4011
Inline connector 	190 Inline connector for plastic frame, extendable for linking chairs with/with armrest and with/without armrest inline connector in combination with a writing tablet on request.	473
Inline connector 	191 Inline connector for plastic frame, permanently attached for assembly without/without armrest inline connector in combination with a writing tablet on request.	273
Inline connector 	238 Inline connector for skid base, with glides for with glides for soft floorings, for assembly with/with, with/without and without/without armrests Inline connector for skid base, with glides with felt insert, for assembly with/with, with/without and without/without armrests	452 504
Clip for seat and row numbering 	192 In conjunction with plastic frames (238/10, 238/11, 238/12) magnetic, can be slotted on the right or left (other frame variants on request)	116
Seat number tag 	193 with number tag board (set of 1-50)	2132
Row number tag 	194 with number tag board (set of 1-30)	1292
Magnetic clip for number tags 	195	399
Writing tablet 	197 Fold-up writing tablet for plastic frame with armrests, can be slotted on, stackable, for the right- or left-hand side (please state when ordering),	1397
Binder for number tag boards 	198	273



26 Range Modus Basic

Design: Klaus Franck, Werner Sauer and wiege, Fritz Frenkler, Justus Kolberg



Technical details

Function

Task chairs with backrest shell and automatic synchro-adjustment: The seat and backrest angle adjusts automatically to the position of the person sitting on chair. When leaning back, the backrest tension increases proportionately. The person using the chair can adjust the tension precisely. The chair can be locked in the front position by engaging a lever. DIN 4550 compliant gas lift for precision adjustment of the seat height.

Frame

Task chairs

Five-star, die-cast aluminum base, coated, polished or bright chrome-plated. Twin-wheel swivel casters with load-dependent braking, made of black polyamide compliant with DIN EN 12529 as the standard version for carpets; with gray soft polyurethane tire

for hard floors. Casters optionally electrically conductive. Die-cast aluminum swing plates, coated to color-match the star base, polished or bright chrome-plated. Black-coated sheet steel mechanism shell.

Counter stool

Star base from the ON 170 range, with additional height-adjustable, bright chrome-plated foot ring, with lock screw to affix it and twin-wheel swivel casters with load-dependent braking.

Seat

Seat shell in black, viscoelastic polypropylene. Cushioning: covered polyurethane one-piece molded foam. Replaceable cover. Side facing: black polyamide for a fabric cover and embossed leather in the same color in the case of a leather cover.

Backrest

Task chairs

Backrest shell in black through-dyed, viscoelastic polypropylene with replaceable back cushioning in covered, cut foam and with integrated, adjustable lumbar support on request.

Armrests

Task chairs

Armrests in black, fiberglass-reinforced polyamide. Task chair model 263/7 also with height-adjustable armrests in the same material.

Standards

The Modus basic task chairs are compliant with the DIN EN 1335 type B office-chair and ANSI/BIFMA X5.1 standards. The Modus Basic task chairs comply with the Ergonomics Approved standard.



www.tuv.com
ID 1000000000



Please note:

the prices for types with cushioning that includes fabrics and leather provided by the customer are given on request.

Task chairs and armchairs

Star base and swivel arms

- 51 Bright chrome-plated
- 52 Polished aluminum
- 53 Coated black (RAL 9011)
- 60 Coated with a silver satin finish (RAL 9006)

Small components

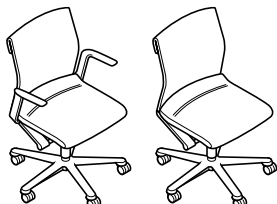
Casters, glides, frame components, adjustment levers

- 41 Black



Standard height backrest

91/102 64 61
 42/53 48 44



263/7

with seat and backrest upholstery,
with armrests,
precision-adjustable height,
automatic synchro-adjustment, tension control
Aluminum coated frame

Additional charge/reduced prices

Polished aluminum frame
Bright chrome-plated aluminum frame

Height-adjustable armrests
Height-adjustable lumbar support

Electrically conductive casters
Without armrests

	51	60	64	65	66	91	74
	54	64	65	66			
	SEK	SEK	SEK	SEK	SEK	SEK	SEK
	11928	12485	13304	17294			
Polished aluminum frame	557	557	557	557			
Bright chrome-plated aluminum frame	1502	1502	1502	1502			
Height-adjustable armrests	1323	1323	1323	1323			
Height-adjustable lumbar support	735	735	735	735			
Electrically conductive casters	515	515	515	515			
Without armrests	-1092	-1092	-1092	-1092			

All task chairs have casters for soft flooring (e. g. carpets). Please order with soft casters (at no extra charge) for hard flooring (e. g. stone, parquet) Electrically conductive casters available for an extra charge.

27 Range

Modus Compact

Design: Klaus Franck, Werner Sauer and wiege, Fritz Frenkler, Justus Kolberg



Technical details

Function

Task chairs with backrest and automatic synchro-adjustment: The seat and backrest tilt adapt automatically to any posture the user adopts. When leaning back, the backrest tension increases proportionately. The person using the chair can adjust the tension precisely. The chair can be locked in the front position by engaging a lever. DIN 4550 compliant gas lift for precision adjustment of the seating height.

Conference / visitor chairs, swivel-mounted with automatic synchro-adjustment, but without front locking position, without any option to precision-adjust the height, also available in a four-leg version or as a cantilever chair, optionally stackable.

Frame

Conference/visitor and task chairs

Five-star, die-cast aluminum base, coated, polished or bright chrome-plated. Twin-wheel swivel casters with load-dependent braking, made of black polyamide compliant with DIN EN 12529 as the standard version for carpets; with gray soft polyurethane facing for hard floors. Casters optionally electrically conductive. Black polyamide glides as the standard version for carpets, with polyurethane glides for hard flooring. Die-cast aluminum swing plates, coated to color-match the star base, polished or bright chrome-plated. Black-coated sheet steel mechanism shell.

Cantilever chair

Round steel tubing frame, bright chrome-plated, matte chrome-plated or coated, with anti-tilt stopper, as the standard version for carpets; with additional glides

for hard flooring, with additional felt insert on request. The stackable version is only available as a bright chrome-plated model.

Seat

Seat shell in black, viscoelastic polypropylene. Cushioning: covered polyurethane one-piece molded foam. Replaceable cover. Side facing: black polyamide for a fabric cover and embossed leather in the same color in the case of a leather cover.

Backrests

Conference/visitor and task chairs

Fiberglass-reinforced, black polyamide frame. Replaceable frame cover made of black polyamide closed-weave or transparent fabric. At the front, non-transparent material can optionally be covered and padded with cut foam. Standard height and medium height backrest with crescent shaped grip, with a fabric cover, covered with black embossed leather, if with a leather cover to color-match the leather. High backrest with curved shoulder support, in the case of fabric covers covered with black embossed leather, with leather covers to color-match the leather. Backrests on task chairs 273, 274 and 275 optionally with integral, adjustable lumbar support (no possible for the version with transparent fabric).

Task chairs and armchairs

Star base, swing plates

- 51 Bright chrome-plated
- 52 Polished aluminum
- 53 Coated black (RAL9011)
- 60 Coated with a silver satin finish (RAL9006)
- 90 Coated with a black textured matte finish (RAL9011)

Visitor chairs

Aluminum oval tubing frame

- 51 Bright chrome-plated
- 53 Coated black (RAL9011)
- 60 Coated with a silver satin finish (RAL9006)
- 62 Clear anodized aluminum
- 90 Coated with a black textured matte finish (RAL9011)

Cantilever chair

Round steel tubing frame

- 51 Bright chrome-plated
- 53 Coated black (RAL9011)
- 60 Coated with a silver satin finish (RAL9006)
- 90 Coated with a black textured matte finish (RAL9011)

Small components

Castors, glides, frame components, adjustment levers

- 41 Black
-



Cantilever chair

Tubular steel frame to match the base frame, bright chrome-plated, matte chrome-plated or coated. Replaceable frame cover made of black polyamide closed-weave or transparent fabric. At the front, non-transparent material can optionally be covered and padded with cut foam. In the case of cantilever chairs 277/7 and 279/7 the crescent-shaped grip is made of black polypropylene, in the version with transparent fabric the crescent-shaped grip is covered with embossed black leather when the chair has fabric or leather covers, when the backrest is covered with fabric, the crescent-shaped grip is covered with black embossed leather and when the backrest is covered with leather to color-match the leather.

Armrests

Conference/visitor and task chairs

Armrests made of black, fiber-glass-reinforced polyamide, height-adjustable on request.

Cantilever chair

Armrest pads made of black polypropylene or beech laminated, with a natural finish.

Standards

The Modus Compact task chairs are compliant with the DIN EN 1335 type B office-chair and ANSI/BIFMA X5.1 standards. The Modus Compact task chairs comply with the Ergonomics Approved standard.

The Modus cantilever and four-leg visitor chairs comply with the DIN EN 16139-L1 and ANSI/BIFMA X 5.1 visitor chair standards.



www.tuv.com
ID 1000000000



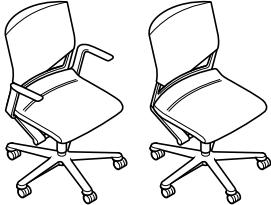
Please note:

the prices for types with cushioning that includes fabrics and leather provided by the customer are given on request.



Standard height backrest

91/102 H64 H64
42/53 H48 H47



273/7

with seat cushioning,
backrest covered with closed-weave fabric,
with armrests,
precision-adjustable height,
automatic synchro-adjustment, tension control
Aluminum coated frame

Additional charge/reduced prices

Backrest upholstered at the front (not available in fabric 68)

Backrest covered at the rear (not available in fabric 68)

Polished aluminum frame

Bright chrome-plated aluminum frame

Height-adjustable armrests

Transparent fabric (at no extra charge)

Height-adjustable lumbar support

Electrically conductive casters

Without armrests

51
54

60
64
65
66
68

91
92

74

SEK SEK SEK SEK

14238 14648 15246 17861

578 746 1449 2688

945 1155 1449 3024

557 557 557 557

1502 1502 1502 1502

1323 1323 1323 1323

0 0 0 0

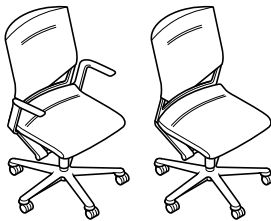
735 735 735 735

515 515 515 515

-1092 -1092 -1092 -1092

Medium-height backrest

98/109 H64 H64
42/53 H48 H47



275/7

with seat cushioning,
backrest covered with closed-weave fabric,
with armrests,
precision-adjustable height,
automatic synchro-adjustment, tension control
Aluminum coated frame

Additional charge/reduced prices

Backrest upholstered at the front (not available in fabric 68)

Backrest covered at the rear (not available in fabric 68)

Polished aluminum frame

Bright chrome-plated aluminum frame

Height-adjustable armrests

Transparent fabric (at no extra charge)

Height-adjustable lumbar support

Electrically conductive casters

Without armrests

51
54

60
64
65
66
68

91
92

74

SEK SEK SEK SEK

14805 15215 15813 18428

945 1155 1449 3255

945 1155 1449 3024

557 557 557 557

1502 1502 1502 1502

1323 1323 1323 1323

0 0 0 0

735 735 735 735

515 515 515 515

-1092 -1092 -1092 -1092

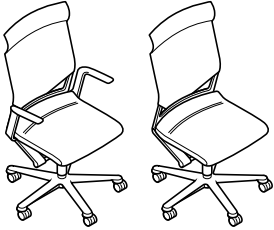
• available

All task chairs have casters for soft flooring (e. g. carpets). Please order with soft casters (at no extra charge) for hard flooring (e. g. stone, parquet) Electrically conductive casters available for an extra charge. A transparent backrest is not possible in conjunction with backrest upholstery and/or lumbar support.



High backrest

106/117 H 64 H 64
42/53 48 47



274/7

with seat cushioning,
backrest covered with closed-weave fabric,
with armrests,
precision-adjustable height,
automatic synchro-adjustment, tension control
Aluminum coated frame

Additional charge/reduced prices

Backrest upholstered at the front (not available in fabric 68)

Backrest covered at the rear (not available in fabric 68)

Polished aluminum frame

Bright chrome-plated aluminum frame

Height-adjustable armrests

Transparent fabric (at no extra charge)

Height-adjustable lumbar support

Electrically conductive casters

Without armrests

	51	60 64 65 66 68	91	74
	54	68	92	74
	SEK	SEK	SEK	SEK
	17588	17997	18596	21210
Backrest upholstered at the front (not available in fabric 68)	945	1155	1449	3255
Backrest covered at the rear (not available in fabric 68)	945	1155	1449	3024
Polished aluminum frame	557	557	557	557
Bright chrome-plated aluminum frame	1502	1502	1502	1502
Height-adjustable armrests	1323	1323	1323	1323
Transparent fabric (at no extra charge)	0	0	0	0
Height-adjustable lumbar support	735	735	735	735
Electrically conductive casters	515	515	515	515
Without armrests	-1092	-1092	-1092	-1092

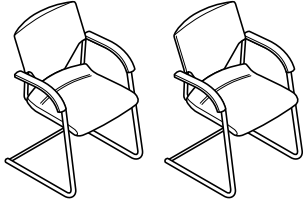
• available

All task chairs have casters for soft flooring (e. g. carpets). Please order with soft casters (at no extra charge) for hard flooring (e. g. stone, parquet) Electrically conductive casters available for an extra charge. A transparent backrest is not possible in conjunction with backrest upholstery and/or lumbar support.



Standard height backrest

85 57 59
43 47



277/7

Backrest covered with closed-weave fabric,
polypropylene armrests
Coated frame

Additional charge/reduced prices

Backrest upholstered at the front (not available in
fabric 68)

Backrest covered at the rear (not available in
fabric 68)

Bright chrome-plated frame

Matte chrome-plated frame

Armrests with embossed leather covering (not
possible with stackable versions)

Wooden armrests

Transparent fabric

Stackable version (only with a bright chrome-
plated frame, up to 5 stackable free-standing)

51
54 60
64
65
66
68 91
92 74

SEK SEK SEK SEK

8390 8799 9398 12012

578 746 1449 2688

945 1155 1449 3024

410 410 410 410

1155 1155 1155 1155

2142 2142 2142 2142

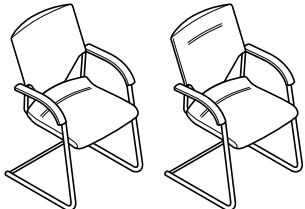
1176 1176 1176 1176

410 410 410 410

914 914 914 914

Medium-height backrest

92 57 59
43 47



279/7

Backrest covered with closed-weave fabric,
polypropylene armrests
Coated frame

Additional charge/reduced prices

Backrest upholstered at the front (not available in
fabric 68)

Backrest covered at the rear (not available in
fabric 68)

Bright chrome-plated frame

Matte chrome-plated frame

Armrests with embossed leather covering (not
possible with stackable versions)

Wooden armrests

Transparent fabric

Stackable version (only with a bright chrome-
plated frame, up to 5 stackable free-standing)

51
54 60
64
65
66
68 91
91 74

SEK SEK SEK SEK

8967 9377 9975 12590

945 1155 1449 3255

945 1155 1449 3024

410 410 410 410

1155 1155 1155 1155

2142 2142 2142 2142

1176 1176 1176 1176

410 410 410 410

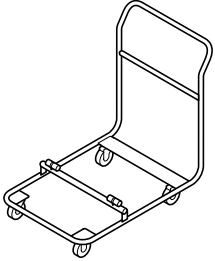
914 914 914 914



Four-wheeled trolley

277
for 6 stackable cantilever chairs

6920



28 Range Modus Medium

Design: Klaus Franck, Werner Sauer and wiege, Fritz Frenkler, Justus Kolberg



Technical details

Function

Task chair with covered backrest and automatic synchro-adjustment: the seat and backrest tilt adapt automatically to any posture the user adopts. When leaning back, the backrest tension increases proportionately. The person using the chair can adjust the tension precisely. The chair can be locked in the front position by engaging a lever. DIN 4550 compliant gas lift for precision-adjustable seating height. Swivel-mounted conference/visitor chairs with automatic synchro-adjustment and precision adjustable height, optionally with rigid, four-star seat bearer or as a cantilever chair.

Frame

Task chairs

Five-star, die-cast aluminum base, coated, polished or bright chrome-plated. Conference/visitor chairs with four-star, die-cast aluminum base, coated, polished or bright chrome-plated. Twin-wheel swivel casters with load-dependent braking, made of black polyamide compliant with DIN EN 12529 as the standard version for carpets; with gray soft polyurethane tire for hard floors. Casters optionally electrically conductive. Black polyamide glides as the standard version for carpets, with polyurethane glides for hard flooring. Die-cast aluminum swing plates, coated to color-match the star base, polished or bright chrome-plated. Black-coated sheet steel mechanism shell.

Conference and visitor chairs

Model 281/5 with a four-star seat bearer made of die-cast aluminum, coated to color-match the star base, polished or bright chrome-plated.

Cantilever chair

Round steel tubing frame, bright chrome-plated, matte chrome-plated or coated, with anti-tilt stopper, as the standard version for carpets; with additional glides for hard flooring, with additional felt insert on request.

Seat

Seat shell in black, viscoelastic polypropylene. Cushioning: covered polyurethane one-piece molded foam. Replaceable cover. Side facing: black polyamide for fabric cover and embossed leather color-matched with the leather cover.

Backrests

Task and visitor chairs

Fiberglass-reinforced, black polyamide frame. Replaceable frame cover made of black polyamide closed-weave or transparent fabric, padded when in the closed-weave version. At the front, non-transparent material can optionally be covered and padded with cut foam. Standard height backrest with a crescent-shaped grip, with a fabric cover, covered with black embossed leather, if with a leather cover to color-match the leather. High backrest with curved shoulder support, in the case of fabric covers covered with black embossed leather, with leather covers to color-match the leather. Task chairs with height-adjustable lumbar support on request.

Cantilever chair

Tubular steel frame to match the base frame, bright chrome-plated, matte chrome-plated or coated. Replaceable frame cover made of black polyamide closed-weave or transparent fabric. At the front, non-transparent material can optionally be covered and padded with cut foam. Where the chair has a fabric cover, the crescent-shaped grip is covered with black embossed leather, in the case of a leather cover to color-match the leather.

Armrests

Task and visitor chairs

Armrests made of black, fiberglass-reinforced, fine grained polyamide. With a black, embossed leather covering on request, when the chair has a leather covering to color-match the

leather. Optional die-cast aluminum armrests, polished or bright chrome-plated, in the case of fabric covers with black leather covering, in the case of leather covers to color-match the leather.

Cantilever chair

Armrest pads made of beech laminate, with a natural finish, polypropylene on request with black embossed leather covering, if the chair is covered in leather to color-match the leather.

Standards

The Modus Medium task chair and visitor/conference chairs are compliant with the DIN EN 1335 type C office-chair and ANSI/BIFMA X5.1 standards. The Modus Medium task chairs and visitor/conference chairs comply with the Ergonomics Approved standard.

The Modus cantilever chairs comply with DIN EN 16139-L1 and ANSI/BIFMA X5.1 standards.



www.tuv.com
ID 1000000000



Please note:

The prices for types with cushioning that includes fabrics and leather provided by the customer are given on request.

Task and visitor chairs

Star base, swing plates

- 51 Bright chrome-plated
- 52 Polished aluminum
- 53 Coated black (RAL 9011)
- 60 Coated with a silver satin finish (RAL 9006)
- 90 Coated with a black textured matte finish (RAL 9011)

Cantilever chair

Round steel tubing frame

- 51 Bright chrome-plated
- 53 Coated black (RAL 9011)
- 60 Coated with a silver satin finish (RAL 9006)
- 90 Coated with a black textured matte finish (RAL 9011)

Small components

Casters, glides, frame components, adjustment levers

- 41 Black



Standard height backrest

91/102 H 68 H 63
42/53 H 51 H 45



283/7

with seat cushioning,
backrest covered with closed-weave fabric,
polyamide armrests,
automatic synchro-adjustment, tension control,
precision-adjustable height
Aluminum coated frame

Additional charge/reduced prices

Backrest upholstered at the front (not available in fabric 68)
Backrest covered at the rear (not available in fabric 68)

Polished aluminum frame
Bright chrome-plated aluminum frame

Transparent fabric
Armrests with embossed leather covering
Polished aluminum armrests with leather covering (in conjunction with a polished aluminum frame)
Bright chrome-plated aluminum armrests with leather covering (in conjunction with a bright chrome-plated aluminum frame)
Lumbar support for task chairs
Electrically conductive casters

51
54
60
64
65
66
68
91
74

SEK SEK SEK SEK

16118 16422 16874 19173

1859 2027 2289 4893

725 872 1082 2300

431 431 431 431

1176 1176 1176 1176

305 305 305 305

1901 1901 1901 1901

2510 2510 2510 2510

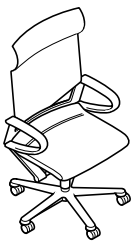
3318 3318 3318 3318

735 735 735 735

515 515 515 515

High backrest

112/123 H 68 H 63
42/53 H 51 H 45



284/7

with seat cushioning,
backrest covered with closed-weave fabric,
polyamide armrests,
automatic synchro-adjustment, tension control,
precision-adjustable height
Aluminum coated frame

Additional charge/reduced prices

Backrest upholstered at the front (not available in fabric 68)
Backrest covered at the rear (not available in fabric 68)

Polished aluminum frame
Bright chrome-plated aluminum frame

Transparent fabric
Armrests with embossed leather covering
Polished aluminum armrests with leather covering (in conjunction with a polished aluminum frame)
Bright chrome-plated aluminum armrests with leather covering (in conjunction with a bright chrome-plated aluminum frame)
Lumbar support for task chairs
Electrically conductive casters

51
54
60
64
65
66
68
91
74

SEK SEK SEK SEK

19310 19614 20066 22365

2174 2279 2489 6363

725 872 1082 2300

431 431 431 431

1176 1176 1176 1176

305 305 305 305

1901 1901 1901 1901

2510 2510 2510 2510

3318 3318 3318 3318

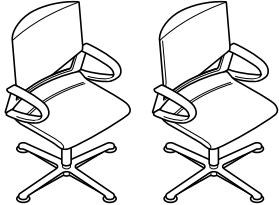
735 735 735 735

515 515 515 515



Standard height backrest

94
 61
 59
 45
 51
 45



281/5

swivel-mounted with a rigid seat bearer, with seat cushioning, backrest covered in closed-weave fabric, polyamide armrests
Aluminum coated frame

Additional charge/reduced prices

Backrest upholstered at the front (not available in fabric 68)

Backrest covered at the rear (not available in fabric 68)

Polished aluminum frame

Bright chrome-plated aluminum frame

Transparent fabric

Armrests with embossed leather covering

Polished aluminum armrests with leather covering (in conjunction with a polished aluminum frame)

Bright chrome-plated aluminum armrests with leather covering (in conjunction with a bright chrome-plated aluminum frame)

Bright chrome-plated aluminum armrests with leather covering (in conjunction with a bright chrome-plated aluminum frame)

		60		
		64		
		65		
	51	66	91	74
	54	68		

SEK SEK SEK SEK

11088 11393 11844 14144

1859 2027 2289 4893

725 872 1082 2300

431 431 431 431

2027 2027 2027 2027

305 305 305 305

1901 1901 1901 1901

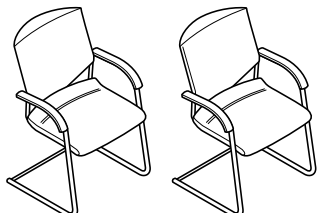
2510 2510 2510 2510

3318 3318 3318 3318



Standard height backrest

91 65 56
43



287/7

with seat cushioning,
backrest covered with closed-weave fabric,
beech laminate armrests
Coated frame

Additional charge/reduced prices

Backrest upholstered at the front (not available in fabric 68)

Backrest covered at the rear (not available in fabric 68)

Bright chrome-plated frame

Matte chrome-plated frame

Armrests with embossed leather covering

Transparent fabric

51
54
60
64
65
66
68
91
74

SEK	SEK	SEK	SEK
8862	9167	9618	11918
1859	2027	2289	4893
725	872	1082	2300
305	305	305	305
872	872	872	872
1050	1050	1050	1050
305	305	305	305

28 Range Modus Executive

Design: Klaus Franck, Werner Sauer and wiege, Fritz Frenkler, Justus Kolberg



Technical details

Function

Task chair with backrest with luxurious upholstery and automatic synchro-adjustment: The seat and backrest angle adjusts automatically to the position of the person sitting on chair. When leaning back, the backrest tension increases proportionately. The person using the chair can adjust the tension precisely. The chair can be locked in the front position by engaging a lever. DIN 4550 compliant gas lift for precision-adjustable seating height.

Swivel-mounted conference/visitor chairs with automatic synchro-adjustment and precision adjustable height, optionally with rigid, four-star seat bearer or as a cantilever chair.

Frame

Task chairs

Five-star base in die-cast aluminum, bright chrome-plated or polished. Conference/visitor chairs with four-star base in die-cast aluminum, bright chrome-plated or polished. Twin-wheel swivel casters with load-dependent braking, made of black polyamide compliant with DIN EN 12529 as the standard version for carpets; with gray soft polyurethane tire for hard floors. Casters optionally electrically conductive. Black polyamide glides as the standard version for carpets, with polyurethane glides for hard flooring. Die-cast aluminum swing plates, polished or bright chrome-plated to match the star base. Black-coated sheet steel mechanism shell. Conference/visitor chair model 281/91 with a four-star seat bearer made of die-cast aluminum, coated to color-match the star base, polished or bright chrome-plated.

Cantilever chair

Round steel tubing frame, bright or matte chrome-plated with anti-tilt stoppers as the standard version for carpets; with additional glides for hard floors, with additional felt insert on request.

Seat

Seat shell in black, viscoelastic polypropylene. Cushioning: covered polyurethane one-piece molded foam. Replaceable cover. Side facing made of embossed leather to match the color of the leather on the seat.

Backrests

Task and visitor chairs

Fiberglass-reinforced, black polyamide frame. Replaceable frame cover made of black polyamide fabric, seat and backrest with leather-covered flat cushion. With a covered back on request. Standard high backrest with straight Conclusion. High backrest with curved shoulder support, with leather-covered flat cushion.

Cantilever chair

Tubular steel frame to match the frame, bright chrome-plated or matte chrome-plated. Replaceable frame cover made of black polyamide fabric, seat and backrest with leather-covered flat cushioning. With a covered back on request. Standard height backrest with a straight upper edge.

Armrests

Task chairs

Armrests made of black, fiberglass-reinforced, fine grained polyamide, with extra, embossed leather covering color-matched with the leather. Optional die-cast aluminum armrests, polished or bright chrome-plated with leather covering and stitched seam in the same color as the leather.

Conference/visitor chairs

Optional die-cast aluminum armrests, polished or bright chrome-plated with leather covering and stitched seam in the same color as the leather.

Cantilever chair

Leather-covered armrest pads to match the color of the chair leather.

Standards

The Modus Executive task chair and visitor/conference chairs are compliant with the DIN EN 1335 type C office-chair and ANSI/BIFMA X5.1 standards. The Modus Executive task chairs and visitor/conference chairs comply with the Ergonomics Approved standard.

The Modus Executive cantilever chairs comply with the DIN EN 16139 - L1 and ANSI/BIFMA X5.1 standards.



www.tuv.com
ID 1000000000



Please note:

The prices for types with cushioning that includes fabrics and leather provided by the customer are given on request.

Task and visitor chairs

Star base, swing plates

- 51 Bright chrome-plated
- 52 Polished aluminum

Cantilever chair

Round steel tubing frame

- 51 Bright chrome-plated
- 58 Matte chrome-plated

Small components

Castors, glides, frame components, adjustment levers

- 41 Black



Standard height backrest

□91/102 □H68 □H65
□42/53 □H51 □H45



283/81

Seat and backrest with leather-covered flat cushioning, polyamide armrests with embossed leather covering, precision-adjustable height, automatic synchro-adjustment, tension control
Polished aluminum frame

Additional charge/reduced prices

Backrest covered at the rear

Bright chrome-plated aluminum frame

Polished aluminum armrests with leather covering (in conjunction with a polished aluminum frame)
Bright chrome-plated aluminum armrests with leather covering (in conjunction with a bright chrome-plated aluminum frame)
Electrically conductive casters

74 87

SEK SEK

35007 37107

2888 3696

924 924

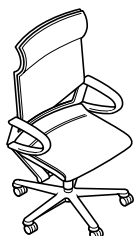
756 756

1922 1922
515 515

74 87

High backrest

□112/123 □H68 □H65
□42/53 □H51 □H45



284/81

Seat and backrest with leather-covered flat cushioning, polyamide armrests with embossed leather covering, precision-adjustable height, automatic synchro-adjustment, tension control
Polished aluminum frame

Additional charge/reduced prices

Backrest covered at the rear

Bright chrome-plated aluminum frame

Polished aluminum armrests with leather covering (in conjunction with a polished aluminum frame)
Bright chrome-plated aluminum armrests with leather covering (in conjunction with a bright chrome-plated aluminum frame)
Electrically conductive casters

43575 46221

2888 3696

924 924

756 756

1922 1922
515 515

SEK SEK



Standard height backrest

□95 □61 □59
□45 □51 □45



281/91

swivel-mounted with fixed seat bearer
Seat and backrest with leather-covered flat
cushioning
Polished aluminum frame

Additional charge/reduced prices

Backrest covered at the rear

Bright chrome-plated armrests with
leather covering, bright chrome-plated aluminum
frame

74 87

SEK SEK

30408 32519

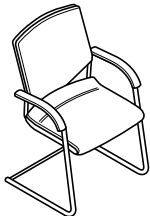
2888 3696

3150 3150

74 87

Standard height backrest

□91 □65 □61
□43



287/81

Seat and backrest with leather-covered flat
cushioning,
leather-covered armrests
Bright chrome-plated frame

Additional charge/reduced prices

Backrest covered at the rear

Matte chrome-plated frame

SEK SEK

27678 29778

2888 3696

1082 1082



290 Range Sola

Design: Justus Kolberg; licensor for products and sales: Davis Furniture, NC, US



Technical details

Function

The conference chair fuses innovative comfort with crisp design and a top quality appeal. The chair's aesthetic is defined by the linear shape of the seat shell and the distinctive lines of the aluminum frame. The frame branches out from the center column into a V-shaped support that culminates in the armrests.

The slender seat shell is swivel-mounted at the front and connected with a V-shaped support by two pressure springs at the back. As a result, the chair rocks back and forward comfortably without any extra mechanical parts required. The sprung pressure can easily be adjusted to suit personal levels of comfort and body weight. DIN 1335-1 compliant gas lift for precision-adjustable seating height.

Can be used in traditional conference and meeting rooms, executive offices and boardrooms, high-quality restaurants or prestigious dining areas.

Frame

Die-cast aluminum five-star base, high-luster polished and coated matte black or with a silver satin finish. Round, black, polyamide multipurpose glides for all types of flooring. For wooden floorings (e. g. parquet) please order with extra felt insert. Optionally with casters. Twin-wheel swivel casters with load-dependent braking, made of black polyamide compliant with DIN EN 12529 as the standard version for carpets; with gray soft polyurethane tare for hard floors. These casters change the seating height or adjustment range to 45 – 51 cm. The gas lift is covered by bright chrome-plated protective tube, coated matte black or with a silver satin finish. When the star base is aluminum high-luster polished, the protective tube is bright chrome-plated. V-shaped die-cast aluminum support, high-luster polished like the star base, coated matte black or with a silver satin finish. Lever for adjusting the seating height, coated matte black or with a silver satin finish. When the star base is aluminum high-luster polished, the lever is bright chrome-plated.

Seat and backrest

Unitary seat and backrest shell made of molded plywood and covered on the rear. Liner made of padded cut foam. Management grade upholstery also with facing all the way round and with quilted stitching.

Armrests

Die-cast aluminum armrests the same as the frame, optionally with additional plastic armrest pad. Chairs with management grade upholstery also come with optional leather-covered armrest pads which are only available in the same color and in combination with leather type 74 or 87.

Standards

The Sola conference chairs comply with the DIN EN 16139-L1 and ANSI/BIFMA X 5.1 standards.



Information

The die-cast aluminum armrests scratch easily.

Conference chairs

Star base, V-shaped support, armrests

- 60 Coated with a silver satin finish (RAL9006)
- 72 High-luster polished aluminum
- 80 Coated black matte (RAL9005)
- 90 Coated with a black textured matte finish (RAL9011)

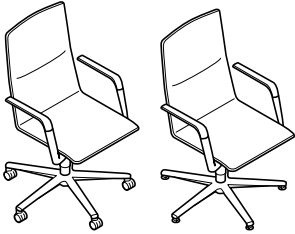
Protective tube, lever for gas lift

- Coated with a silver satin finish
- Bright chrome-plated
- Coated black matte
- Coated with a black textured matte finish (RAL9011)



Medium-height backrest

101/110 H67 H68
44/53 48 44



291/7

Fully upholstered unitary seat and backrest shell,
with armrests,
precision-adjustable height
Aluminum coated frame

Additional charge/reduced prices

Plastic armrest pad

High-luster polished aluminum frame
Casters (45–51 cm seating height)

		60		
		64		
		65		
		66	91	
	51	68	92	74

SEK SEK SEK SEK

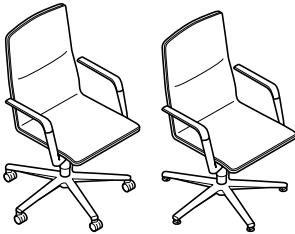
18512 19026 20076 23237

651 651 651 651

630 630 630 630
515 515 515 515

Medium-height backrest

101/110 H67 H68
44/53 48 44



291/71

Seat and backrest with management grade
upholstery,
with armrests,
precision-adjustable height
Aluminum coated frame

Additional charge/reduced prices

Plastic armrest pad

Leather-covered armrest pad

High-luster polished aluminum frame
Casters (45–51 cm seating height)

		60			
		64			
		65			
		68	91	74	
	51				87

SEK SEK SEK SEK SEK

19814 20465 21504 25137 30219

651 651 651 651 651

1680 1680 1680 1680 1680

630 630 630 630 630
515 515 515 515 515

295 Range Intra

Design: Phoenix Design



Technical details

Function

Conference, lounge and executive chair range in a contemporary design with integrated synchronous adjustment mechanism that automatically adapts to the weights of people sitting on it.

Frame

Five-star base in die-cast aluminum bright chrome-plated, matte-polished and coated in black or white with a textured matte finish. Round plastic multipurpose glides for all types of flooring, color-matched with the frame: bright chrome-plated when the frame is bright chrome-plated, matte-polished or coated in white with a textured matte finish, in black when the frame is coated in black with a textured matte finish. For hard floorings (e. g. parquet) please order with extra felt insert. Version on glides optionally available with swivel-return mechanism and without height adjustment (seating height 45 cm). Optionally with casters. Twin wheel swivel casters with load-dependent braking, made of black polyamide compliant with DIN EN 12529 as the standard version for carpets; with gray soft polyurethane facing for hard floors. The gas lift is covered with a protective tube color-matched with the frame, bright chrome-plated, matte-polished or coated black or white with a textured matte finish. Precision adjustable seating height via a gas lift.

Seat

Seat shell made of fiberglass-reinforced polypropylene covered with fabric or leather, with polypropylene seat upholstery panel, seat cushioning made of polyurethane with padding in the same material as the cover with side facings. The cushioning and covers are replaceable. The synchronous adjustment mechanism with automatic weight adjustment is integrated between the seat shell and upholstery element.

Backrest

Backrest shell made of plywood, fully padded with polyurethane (CFC-free) with additional padding. Curved flat steel backrest bearer to connect with the synchronous adjustment mechanism

Armrests



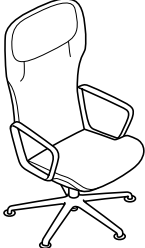
Die-cast aluminum armrests, bright chrome-plated, matte-polished or coated in black or white with a textured matte finish depending on the type of frame, optionally with integrated, leather-covered armrest pad. The armrest pads come in black 74/99 leather for fabric-covered models and are the same color as the leather in leather-covered models. The controls for adjusting the height and locking it in place are integrated in the armrests.

Standards

Intra chairs are compliant with the DIN EN 1335 type C office furniture standard.

Conference chairs	Base frame	Gas lift cover	Multipurpose glides	Casters
51	Bright chrome-plated	Bright chrome-plated	Bright chrome-plated	Black
79	Matte-polished aluminum	Matte-polished aluminum	Bright chrome-plated	Black
90	Coated with a black textured matte finish (RAL 9011)	Coated with a black textured matte finish (RAL 9011)	Black	Black
91	Coated white with a textured matte finish (RAL 9016)	Coated white with a textured matte finish (RAL 9016)	Black	Black



				60	64	65	66	91	92	74	87		
				51									
Standard height backrest ■ 86/96 ■ H 65 ■ H 68 ■ 41/51 	295/6 with seat cushioning, fully upholstered backrest, with armrests, precision-adjustable height. Synchronous adjustment mechanism with automatic weight adjustment Aluminum coated frame Additional charge/reduced prices Leather-covered armrest pad Matte polished aluminum frame Bright chrome-plated aluminum frame Swivel-return mechanism (then not height- adjustable) Casters			SEK	SEK	SEK	SEK	SEK	SEK	SEK	SEK		
				19415	19898	21515	25326	30555					
				1880	1880	1880	1880	1880					
				893	893	893	893	893					
				5156	5156	5156	5156	5156					
				1407	1407	1407	1407	1407					
				725	725	725	725	725					
						51							
					60	64	65	66	91	92	74	87	
Medium-height backrest ■ 103/113 ■ H 65 ■ H 68 ■ 41/51 	295/7 with seat cushioning, fully upholstered backrest, with armrests precision-adjustable height Synchronous adjustment mechanism with automatic weight adjustment Aluminum coated frame Additional charge/reduced prices Leather-covered armrest pad Matte polished aluminum frame Bright chrome-plated aluminum frame Swivel-return mechanism (then not height- adjustable) Casters			SEK	SEK	SEK	SEK	SEK	SEK	SEK			
				22008	22565	24371	26639	33243					
				1880	1880	1880	1880	1880					
				893	893	893	893	893					
				5156	5156	5156	5156	5156					
				1407	1407	1407	1407	1407					
				725	725	725	725	725					
						51							
					60	64	65	66	91	92	74	87	
High backrest ■ 120/130 ■ H 65 ■ H 68 ■ 41/51 	295/8 with seat cushioning fully upholstered backrest with armrests precision-adjustable height synchronous adjustment mechanism with automatic weight adjustment Aluminum coated frame Additional charge/reduced prices Leather-covered armrest pad Matte polished aluminum frame Bright chrome-plated aluminum frame Swivel-return mechanism (then not height- adjustable) Casters			SEK	SEK	SEK	SEK	SEK	SEK	SEK			
				25757	26471	28592	31847	36992					
				1880	1880	1880	1880	1880					
				893	893	893	893	893					
				5156	5156	5156	5156	5156					
				1407	1407	1407	1407	1407					
				725	725	725	725	725					
						51							
					60	64	65	66	91	92	74	87	

30 Range Graph

Design: jehs+laub



Technical details

Function

Distinctive, high-end, standalone conference chair in two backrest heights. Armrests stylishly link the seat and backrest. Exceptional, sprung (and at the sides also elastic) comfort due to three-point support with rear spring strut and sophisticated upholstery. Can be used in traditional conference and meeting rooms, executive offices and boardrooms or prestigious dining areas.

Frame

Models 301/5, 302/5 and 304/5: Four-star base made of die-cast aluminum, coated black or signal white, matte polished or bright chrome-plated. Black, multipurpose glides made of plastic for all types of flooring. Optionally with base glides with larger contact area for sensitive floorings, either to match the star base coated black or in signal white, matte chrome-plated (matte-polished star base) or bright chrome plated (bright chrome-plated star base). Black polyamide glides for carpets. For hard floors (e.g. stone), please order with soft TPU, for wooden floors (e.g. parquet) with additional felt. These glides change the seating height to 44 cm. Optionally with casters for four-star bases compliant with the DIN EN 1335 and ANSI/BIFMA X 5.1 standards for conference chairs.

Black polyamide twin-wheel swivel casters with load-dependent braking compliant with the DIN EN 12529 standard, with black polyurethane tire for multipurpose use on hard and soft floorings: The casters' black plastic shell comes either with a chrome-plated ring (for a coated star base), matte chrome-plated ring (for a matte polished star base) or a chrome-plated ring (for a bright chrome-plated star base). These casters change the seating height to 45 cm.

Models 301/5, 302/5 and 304/5: Swivel-mounted column with Y-shaped seat bearer made of die-cast aluminum, coated in black or signal white, matte polished or bright chrome-plated to match the star base. Permanently elastic, rubber/metal connecting elements. Sprung elastic strut made of top-quality spring steel in black. Models 301/8, 302/8 and 304/8: Swivel-mounted column with seat bearer and integrated rocking mechanism made of die-cast aluminum and high-luster polished or matte polished.

Models 301/6, 302/6, 304/6, 301/7, 302/7, 304/7, 301/8, 302/8 and 304/8: Die-cast aluminum five-star base coated in black or signal white, matte polished or bright chrome-plated, with casters for five-star

bases compliant with the DIN EN 1335 and ANSI/BIFMA X 5.1 standards for conference chairs. Twin-wheel swivel casters with load-dependent braking made of black polyamide compliant with DIN EN 12529, with black polyurethane tire for multipurpose use on hard and soft floors: Black plastic shell for the casters either with chrome-plated ring (coated star base), matte chrome-plated ring (matte polished star base) or chrome-plated ring (bright chrome-plated star base).

All models (except for 301/8, 302/8 and 304/8) with Y-shaped seat bearer made of die-cast aluminum, coated in black or signal white, matte polished or bright chrome-plated to match the star base. Permanently elastic, rubber/metal connecting elements. Sprung elastic strut made of top-quality spring steel in black.

Models 301/6, 302/6 and 304/6 with swivel-mounted columns.

Models 301/7, 302/7, 304/7 and models 301/8, 302/8 and 304/8 with precision-adjustable seating height via a gas lift column.

Seat and backrest

Seat and backrest frame made of metal, with wave springs, fully covered in polyurethane foam with additional cushioning and

replaceable textile or leather covers. Covers on the 304/5, 304/6, 304/7, 304/8 (Iconic Edition) models come with diamond-shaped top stitching and cut foam laminated on both sides and incorporated into the covers and are only available in 74/99, 74/16, 87/99, 87/85 leather.

Armrests

Armrests that connect the seat and backrest made of die-cast aluminum and to match the frame coated black or signal white, matte polished or bright chrome plated. Optionally with integrated, leather-covered armrest pads, in black 74/99 leather when the chair has fabric covers, in the same color and material in the case of leather covers.

Standards

The Graph chairs comply with the DIN EN 16139-L1 and ANSI/BIFMA X 5.1 office-chair standard.



Information

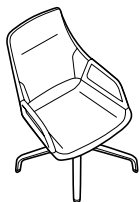
The prices for types with cushioning that includes fabrics and leather provided by the customer are given on request.

Conference chairs	Star base	Gas lift column (models 301/7, 302/7, 301/8 and 302/8)	Synchro-adjustment mechanism (models 301/8 and 302/8)	Casters	Base glides
49	Coated white (RAL9003)	Bright chrome-plated	High-luster polish	Black plastic shell mit chrome-plated ring	Color-matched or coated black or white
51	Bright chrome-plated	Bright chrome-plated	High-luster polish	Black plastic shell mit chrome-plated ring	Bright chrome-plated
53	Coated black (RAL9011)	Coated black	High-luster polish	Black plastic shell mit chrome-plated ring	Color-matched or coated black or white
79	Matte-polished aluminum	Bright chrome-plated	Matte-polished aluminum	Black plastic shell with chrome-plated ring	Matte chrome-plated
90	Coated with a black textured matte finish (RAL9011)	Coated black	High-luster polish	Black plastic shell mit chrome-plated ring	Color-matched or coated black or white
91	Coated white with a textured matte finish (RAL9016)	Bright chrome-plated	High-luster polish	Black plastic shell mit chrome-plated ring	Color-matched or coated black or white



Medium-height backrest

102 62 64
43 48 47



301/5

Swivel-mounted,
fully upholstered unitary seat and backrest
frame,
with armrests
Aluminum coated frame

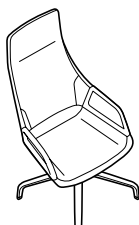
Additional charge/reduced prices

Leather-covered armrest pad
Swivel-return mechanism
Matte polished aluminum frame
Bright chrome-plated aluminum frame
Base glides (44 cm seating height)
Casters (45 cm seating height)

	60	64	65	66	68
	51	68	91	74	87
	SEK	SEK	SEK	SEK	SEK
	25883	26534	27710	31532	35858
	3371	3371	3371	3371	3371
	1523	1523	1523	1523	1523
	1386	1386	1386	1386	1386
	6122	6122	6122	6122	6122
	651	651	651	651	651
	1050	1050	1050	1050	1050

High backrest

125 62 64
43 48 47



302/5

Swivel-mounted,
fully upholstered unitary seat and backrest
frame,
with armrests
Aluminum coated frame

Additional charge/reduced prices

Leather-covered armrest pad
Swivel-return mechanism
Matte polished aluminum frame
Bright chrome-plated aluminum frame
Base glides (44 cm seating height)
Casters (45 cm seating height)

	60	64	65	66	68
	51	68	91	74	87
	SEK	SEK	SEK	SEK	SEK
	30440	31385	32844	37968	43134
	3371	3371	3371	3371	3371
	1523	1523	1523	1523	1523
	1386	1386	1386	1386	1386
	6122	6122	6122	6122	6122
	651	651	651	651	651
	1050	1050	1050	1050	1050

Medium-height backrest

104 62 64
45 48 47



301/6

Fully upholstered unitary seat and backrest
frame,
with armrests
Aluminum coated frame

Additional charge/reduced prices

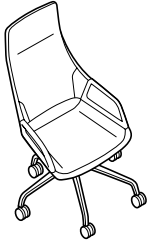
Leather-covered armrest pad
Matte polished aluminum frame
Bright chrome-plated aluminum frame

	60	64	65	66	68
	51	68	91	74	87
	SEK	SEK	SEK	SEK	SEK
	27195	27846	29022	32844	37170
	3371	3371	3371	3371	3371
	1386	1386	1386	1386	1386
	6122	6122	6122	6122	6122



High backrest

127 62 64
45 48 47



302/6

Fully upholstered unitary seat and backrest frame, with armrests
Aluminum coated frame

Additional charge/reduced prices

Leather-covered armrest pad
Matte polished aluminum frame
Bright chrome-plated aluminum frame

	51	60 64 65 66 68	91 92	74	87
SEK	SEK	SEK	SEK	SEK	SEK
	31752	32697	34157	39281	44447
	3371	3371	3371	3371	3371
	1386	1386	1386	1386	1386
	6122	6122	6122	6122	6122

Medium-height backrest

100/110 62 64
41/51 48 47



301/7

Fully upholstered unitary seat and backrest frame, with armrests
precision-adjustable height
Aluminum coated frame

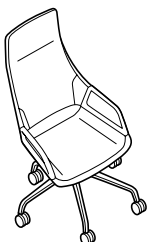
Additional charge/reduced prices

Leather-covered armrest pad
Matte polished aluminum frame
Bright chrome-plated aluminum frame

	51	60 64 65 66 68	91 92	74	87
SEK	SEK	SEK	SEK	SEK	SEK
	27458	28109	29285	33107	37433
	3371	3371	3371	3371	3371
	1386	1386	1386	1386	1386
	6122	6122	6122	6122	6122

High backrest

123/133 62 64
41/51 48 47



302/7

Fully upholstered unitary seat and backrest frame, with armrests,
precision-adjustable height
Aluminum coated frame

Additional charge/reduced prices

Leather-covered armrest pad
Matte polished aluminum frame
Bright chrome-plated aluminum frame

	51	60 64 65 66 68	91 92	74	87
SEK	SEK	SEK	SEK	SEK	SEK
	32015	32960	34419	39543	44709
	3371	3371	3371	3371	3371
	1386	1386	1386	1386	1386
	6122	6122	6122	6122	6122



Medium-height backrest

104 62 64
39/49 47 48



301/8

Fully upholstered unitary seat and backrest frame, with armrests, precision-adjustable height, rocking mechanism
Aluminum coated frame

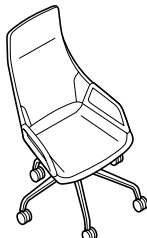
Additional charge/reduced prices

Leather-covered armrest pad
Matte polished aluminum frame
Bright chrome-plated aluminum frame

	51	60 64 65 66 68	91 92	74	87
	SEK	SEK	SEK	SEK	SEK
	30135	30786	31962	35784	40110
	3371	3371	3371	3371	3371
	1386	1386	1386	1386	1386
	6122	6122	6122	6122	6122

High backrest

123/133 62 64
39/49 47 48



302/8

Fully upholstered unitary seat and backrest frame, with armrests, precision-adjustable height, rocking mechanism
Aluminum coated frame

Additional charge/reduced prices

Leather-covered armrest pad
Matte polished aluminum frame
Bright chrome-plated aluminum frame

	51	60 64 65 66 68	91 92	74	87
	SEK	SEK	SEK	SEK	SEK
	34692	35637	37097	42221	47387
	3371	3371	3371	3371	3371
	1386	1386	1386	1386	1386
	6122	6122	6122	6122	6122



High backrest

W 125 H 62 D 64
W 43 H 48 D 47



304/5

Swivel-mounted,
unitary seat and backrest frame,
fully upholstered
with armrests
Aluminum coated frame

Additional charge/reduced prices

Leather-covered armrest pad
Swivel-return mechanism
Matte polished aluminum frame
Bright chrome-plated aluminum frame
Base glides (44 cm seating height)
Casters (45 cm seating height)

74 87

SEK SEK

44415 49571

3371 3371

1523 1523

1386 1386

6122 6122

651 651

1050 1050

74 87

High backrest

W 127 H 62 D 64
W 45 H 48 D 47



304/6

Unitary seat and backrest frame,
fully upholstered
with armrests
Aluminum coated frame

Additional charge/reduced prices

Leather-covered armrest pad
Matte polished aluminum frame
Bright chrome-plated aluminum frame

SEK SEK

45728 50883

3371 3371

1386 1386

6122 6122



High backrest

123/133 H 62 H 64
41/51 48 47



304/7

Unitary seat and backrest frame,
fully upholstered
with armrests
precision-adjustable height,
Aluminum coated frame

Additional charge/reduced prices

Leather-covered armrest pad
Matte polished aluminum frame
Bright chrome-plated aluminum frame

74 87

SEK SEK

45990 51146

3371 3371

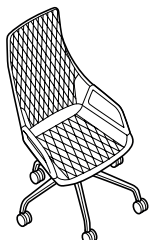
1386 1386

6122 6122

74 87

High backrest

127/137 H 62 H 64
39/49 47 48



304/8

Unitary seat and backrest frame,
fully upholstered
with armrests
precision-adjustable height,
rocking mechanism
Aluminum coated frame

Additional charge/reduced prices

Leather-covered armrest pad
Matte polished aluminum frame
Bright chrome-plated aluminum frame

SEK SEK

48668 53823

3371 3371

1386 1386

6122 6122

300 Range Graph tables

Design: jehs+laub



Technical details

Function

A high-quality table system for traditional conference and executive workspaces.

Frame

Table legs are made of bright chrome-plated die-cast aluminum, matte polished chrome, or coated in black, or signal white. Table crossbeams/underframes are made of aluminum extruded profile, color-matched with the table legs (except for model 300/50, reinforcement underframes on the inside are always black). Table top bearers to connect to the table top made of black coated steel, exception: table top bearer is coated white when the frame is coated white. Adjustable table glides (10 mm) are made of steel, the glide cover is made of die-cast zinc, surface the same as the frame, with glide insert made of polyamide for soft floorings and polyurethane for hard floorings or with felt insert.

Table tops

Medium density fiberboard (MDF).

Table top group 2 – veneer

Table top thickness 26 mm

Variant 1:

Veneers made of beech, oak or ash based on the Wilkhahn woodstain color samples with color-matched and symmetrically curved table edge, protected with colorless natural wood varnish.

Variant 2:

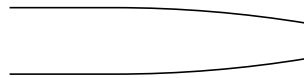
Maple, walnut or elm veneer with color-matched and symmetrically curved table edge, protected with colorless natural wood varnish.



Symmetrically curved wood edging

Table top group 6 - varnished

Table top 25 mm thick, white or black varnish-coated, with color-matched and symmetrically curved table edge.



Symmetrically curved wood edging

Accessories

Cable channel

Cable channel made of aluminum extruded profile, retractable, coated black.

Cable lids, opening lengthwise and across

Cable lid opens lengthwise, beveled on both of the long sides (can be used on both sides), gas-lift-damped automatic opening mechanism, cable lid on both sides in the same color and material as the table. Cable lid: 300 x 165 mm Cable lid opens crosswise, beveled on one long side (can be used on one side), gas-lift-damped automatic opening mechanism, the cable lid is in the same material and color on both sides. Cable lid: 300 x 165 mm.

Basic cable lid

Aluminum installation frame with cable lid and brushed profile. Cable lid: 300 x 120 mm.

Vertical cable management

Flexible black cable sheath. Length including table attachment and floor panel approx. 75 cm. Clips for holding the plastic cables, screwed to the frame leg, detachable cover made of sheet steel coated in signal white, black with a textured matte finish or dark gray with a textured matte finish.

Standards

The Graph tables comply with the DIN EN 527 and the ANSI / BIFMA X 5.5 standards.



www.tuv.com
ID 1000000000



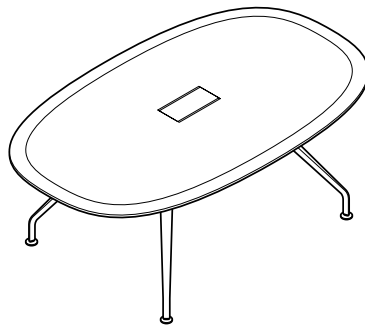
Tables

Legs, crossbeams, underframes

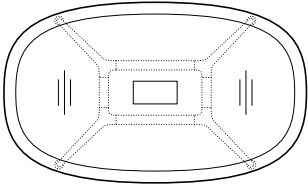
49	Coated white (RAL9003)
51	Bright chrome-plated
53	Coated black (RAL9011)
76	Matte-polished chrome
90	Coated with a black textured matte finish (RAL9011)
91	Coated white with a textured matte finish (RAL9016)

Table top bearers

Coated in signal white
Coated black
Coated black
Coated black
Coated with a black textured matte finish (RAL9011)
Coated white with a textured matte finish (RAL9016)



6	2	2
varnished	Veneer variant 1	Veneer variant 2
SEK	SEK	SEK

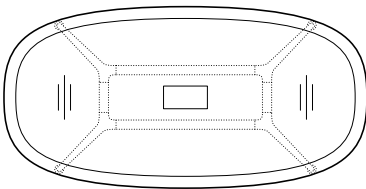


300/00
120 x 200, H73
For 6 people
Coated frame
Matte-polished chrome frame
Bright chrome-plated aluminum frame

51881	53802	55125
70655	72576	73899
66287	68208	69531

Additional charge/reduced prices

Cable channel	5901	5901	5901
Vertical cable management for the table leg	1722	1722	1722
300/011 Cable lid opening lengthwise	15057	15876	17157
300/05 1 Basic cable lid	1817	1817	1817
Socket strip, strain anchor, vertical cable management, see accessories page 161	•	•	•

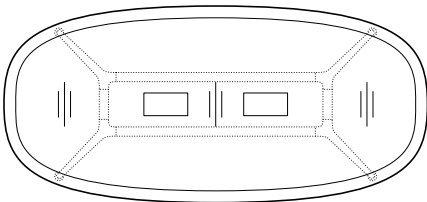


300/00
120 x 240, H 73
For 6 people
Coated frame
Bright chrome-plated aluminum frame
Matte-polished chrome frame

53519	55629	57246
68418	70529	72146
73311	75422	77039

Additional charge/reduced prices

Cable channel	5901	5901	5901
Vertical cable management for the table leg	1722	1722	1722
300/011 Cable lid opening lengthwise	15057	15876	17157
300/05 1 Basic cable lid	1817	1817	1817
Socket strip, strain anchor, vertical cable management, see accessories page 161	•	•	•



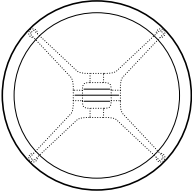
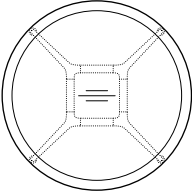
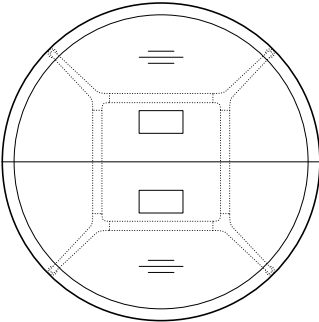
300/00
130 x 280, H 73
For 8 people
Coated frame
Bright chrome-plated aluminum frame
Matte-polished chrome frame

58716	61058	63084
75149	77490	79517
81155	83496	85523

Additional charge/reduced prices

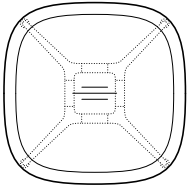
Cable channel	5901	5901	5901
Vertical cable management for the table leg	1722	1722	1722
300/012 Cable lids opening lengthwise	30114	31752	34314
300/05 2 Basic cable lids	3633	3633	3633
Socket strip, strain anchor, vertical cable management, see accessories page 161	•	•	•



		6	2	2
		varnished	Veneer variant 1	Veneer variant 2
		SEK	SEK	SEK
	300/30 Ø 125, H 73 For 4 people Coated frame Bright chrome-plated aluminum frame Matte-polished chrome frame	44342	46379	47240
		57708	59745	60606
		61173	63210	64071
	Additional charge/reduced prices Vertical cable management for the table leg	1722	1722	1722
	300/30 Ø 150, H 73 For 4 people Coated frame Bright chrome-plated aluminum frame Matte-polished chrome frame	47964	50432	51702
		61950	64418	65688
		66161	68628	69899
	Additional charge/reduced prices Vertical cable management for the table leg	1722	1722	1722
	300/40 Ø 210, H 73 For 8 people, consisting of 2 segments Coated frame Bright chrome-plated aluminum frame Matte-polished chrome frame	72272	75285	77438
		87350	90363	92516
		90972	93986	96138
	Additional charge/reduced prices Cable channel	19709	19709	19709
	Vertical cable management for the table leg	1722	1722	1722
	300/02 2 Basic cable lids open sideways	30114	31752	34314
	300/05 2 Basic cable lids	3633	3633	3633
	Socket strip, strain anchor, vertical cable management, see accessories page 161	•	•	•



6
varnished
2
Veneer variant 1
2
Veneer variant 2
SEK SEK SEK

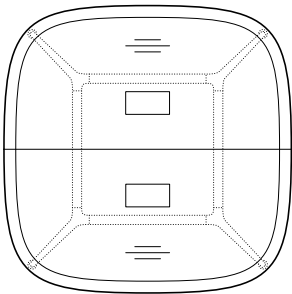


300/30
120 x 120, H 73
For 4 people
Coated frame
Bright chrome-plated aluminum frame
Matte-polished chrome frame

46326 47912 48752
60071 61656 62496
63966 65552 66392

Additional charge/reduced prices
Vertical cable management for the table leg

1722 1722 1722

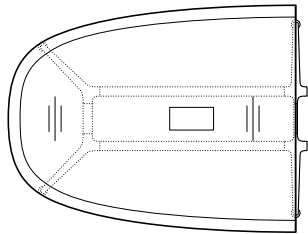
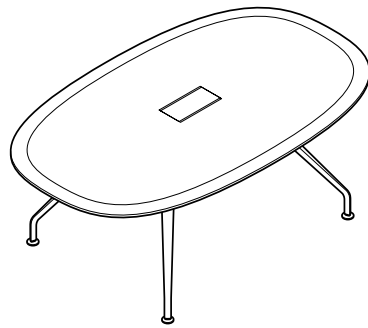


300/40
190 x 190, H 73
For 8 people,
consisting of 2 segments
Coated frame
Bright chrome-plated aluminum frame
Matte-polished chrome frame

71537 74340 76535
86793 89597 91791
91875 94679 96873

Additional charge/reduced prices
Cable channel
Vertical cable management for the table leg
300/02 2 Basic cable lids open sideways
300/05 2 Basic cable lids
Socket strip, strain anchor, vertical cable management, see accessories page 161

20286 20286 20286
1722 1722 1722
30114 31752 34314
3633 3633 3633
• • •



300/14

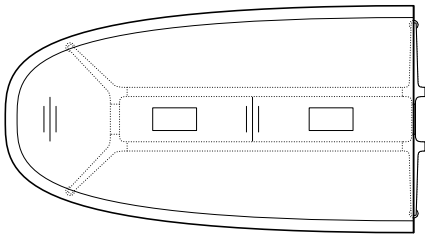
Starting element
150 x 190 H 73
Coated frame
Bright chrome-plated aluminum frame
Matte-polished chrome frame

Additional charge/reduced prices

Cable channel
Vertical cable management for the table leg
300/011 Cable lid opening lengthwise see page 308
300/05 1 Basic cable lid
Socket strip, strain anchor, vertical cable management, see accessories
page 161

6	2	2
varnished	Veneer variant 1	Veneer variant 2
SEK	SEK	SEK

56396	58212	59955
71190	73007	74750
76461	78278	80021
6437	6437	6437
1722	1722	1722
15057	15876	17157
1817	1817	1817
•	•	•



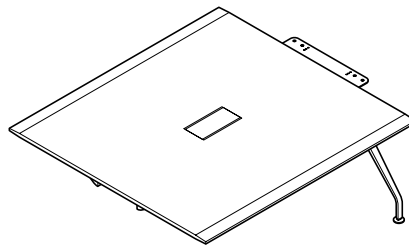
300/14

Starting element
150 x 270 H 73
Coated frame
Bright chrome-plated aluminum frame
Matte-polished chrome frame

Additional charge/reduced prices

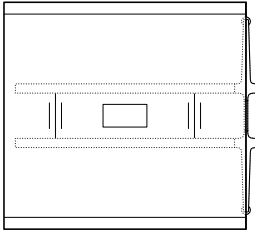
Cable channel
Vertical cable management for the table leg
300/011 Cable lid opening lengthwise see page 308
300/05 2 Basic cable lids
Socket strip, strain anchor, vertical cable management, see accessories
page 161

64617	67022	69458
81365	83769	86205
88116	90521	92957
6437	6437	6437
1722	1722	1722
30114	31752	34314
3633	3633	3633
•	•	•



varnished
Veneer variant 1
Veneer variant 2

SEK SEK SEK



300/16

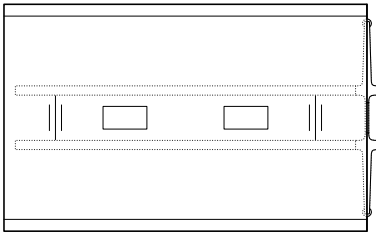
Intermediate element
150 x 160 H 73
Coated frame
Bright chrome-plated aluminum frame
Matte-polished chrome frame

45129 46946 48689
54989 56805 58548
58517 60333 62076

Additional charge/reduced prices

Cable channel
Vertical cable management for the table leg
300/011 Cable lid opening lengthwise see page 308
300/05 1 Basic cable lid
Socket strip, strain anchor, vertical cable management, see accessories
page 161

7949 7949 7949
1722 1722 1722
15057 15876 17157
1817 1817 1817
• • •



300/16

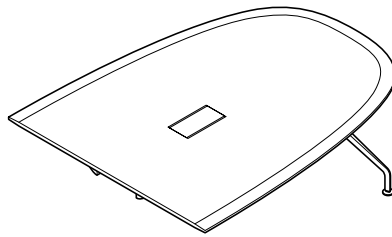
Intermediate element
150 x 240 H 73
Coated frame
Bright chrome-plated aluminum frame
Matte-polished chrome frame

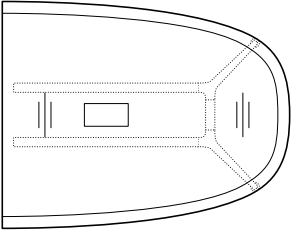
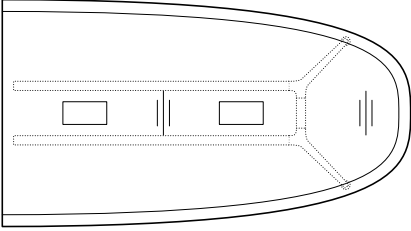
53351 55755 58191
65132 67536 69972
70151 72555 74991

Additional charge/reduced prices

Cable channel
Vertical cable management for the table leg
300/012 Cable lids opening lengthwise see page 308
300/05 2 Basic cable lids
Socket strip, strain anchor, vertical cable management, see accessories
page 161

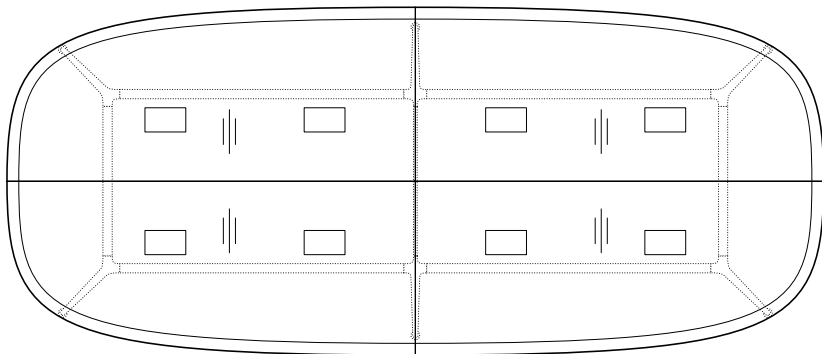
7949 7949 7949
1722 1722 1722
30114 31752 34314
3633 3633 3633
• • •



		6	2	2
		varnished	Veneer variant 1	Veneer variant 2
		SEK	SEK	SEK
	300/15 Finishing element 150 x 190 H 73 Coated frame Bright chrome-plated aluminum frame Matte-polished chrome frame	37601 47460 50988	39417 49277 52805	41160 51020 54548
	Additional charge/reduced prices Cable channel Vertical cable management for the table leg 300/011 Cable lid opening lengthwise see page 308 300/05 1 Basic cable lid Socket strip, strain anchor, vertical cable management, see accessories page 161	6437 1722 15057 1817	6437 1722 15876 1817	6437 1722 17157 1817
	300/15 Finishing element 150 x 270 H 73 Coated frame Bright chrome-plated aluminum frame Matte-polished chrome frame	45822 57603 62622	48227 60008 65027	50663 62444 67463
	Additional charge/reduced prices Cable channel Vertical cable management for the table leg 300/01 2 Cable lids opening lengthwise see page 308 300/05 2 Basic cable lids Socket strip, strain anchor, vertical cable management, see accessories page 161	6437 1722 30114 3633	6437 1722 31752 3633	6437 1722 34314 3633



varnished	Veneer variant 1	Veneer variant 2
SEK	SEK	SEK



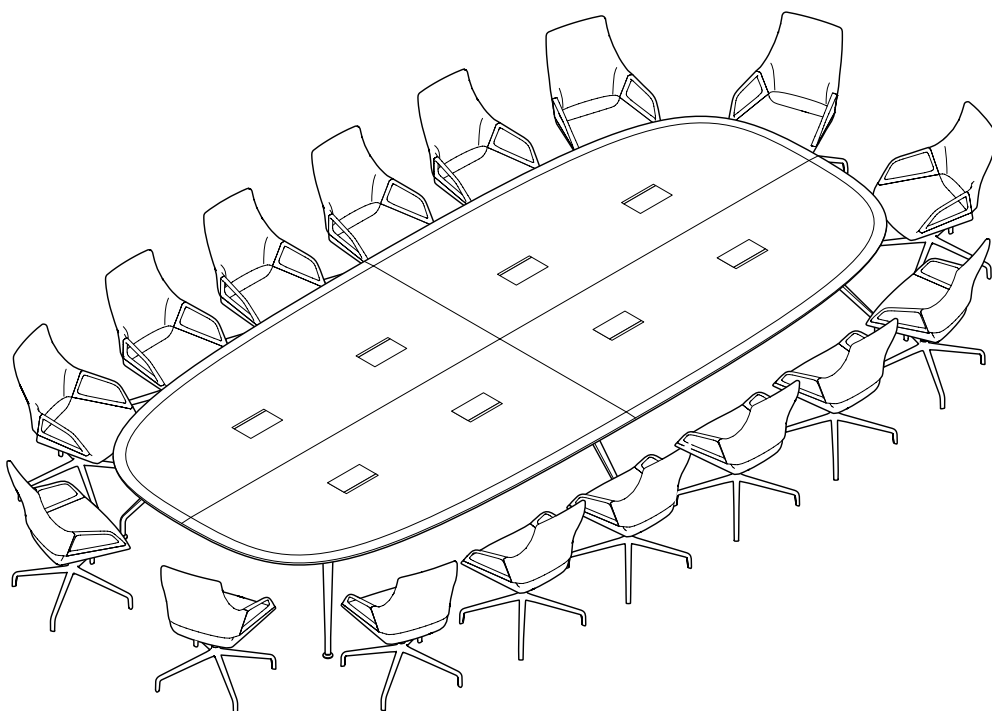
300/25
230 x 540, H 73
For 16 people,
consisting of 4 segments
Coated frame
Bright chrome-plated aluminum frame
Matte-polished chrome frame

172127	178437	185850
208446	214757	222170
222558	228869	236282

Additional charge/reduced prices

Cable channel
Vertical cable management for the table leg
300/02 8 Cable lids open sideways
300/05 8 Basic cable lids
Socket strip, strain anchor, vertical cable management, see accessories page 161

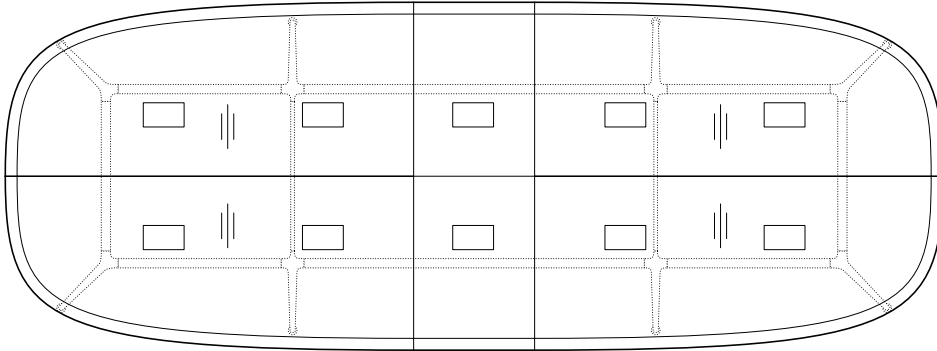
50936	50936	50936
1722	1722	1722
120456	127008	137256
14532	14532	14532





6
varnished
2
Veneer variant 1
2
Veneer variant 2

SEK SEK SEK



300/26

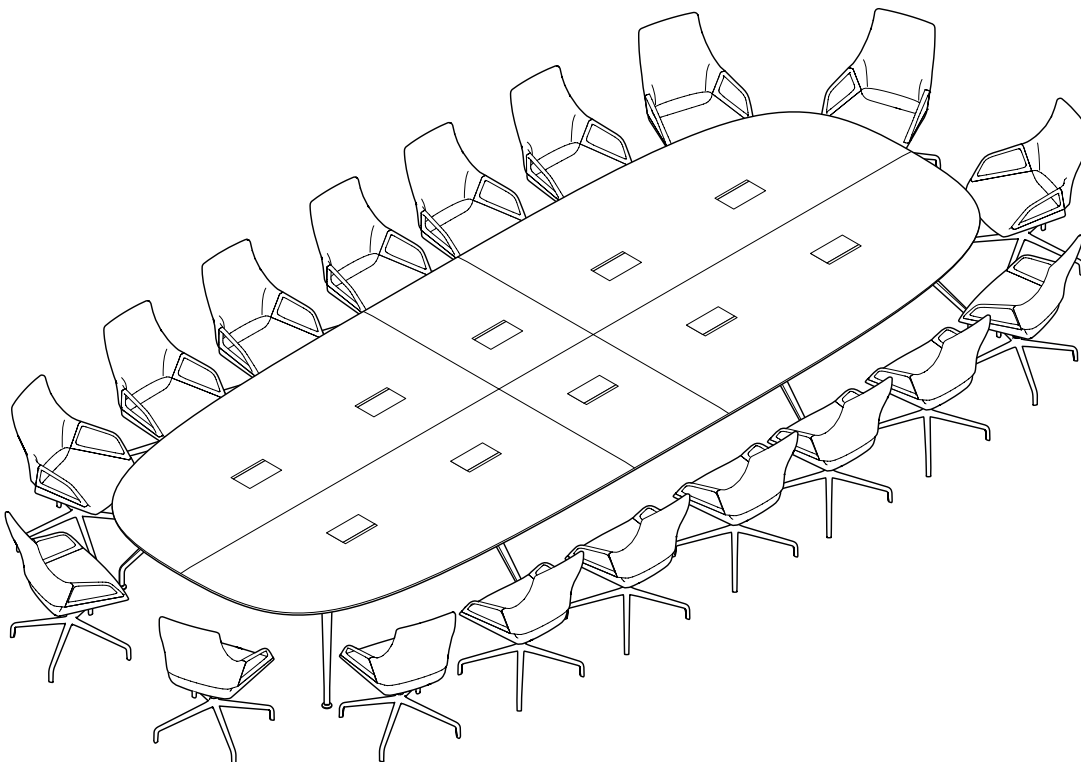
230 x 620, H 73
For 18 people,
consisting of 6 segments
Coated frame
Bright chrome-plated aluminum frame
Matte-polished chrome frame

217886	226664	233709
258353	267131	274176
274481	283259	290304

Additional charge/reduced prices

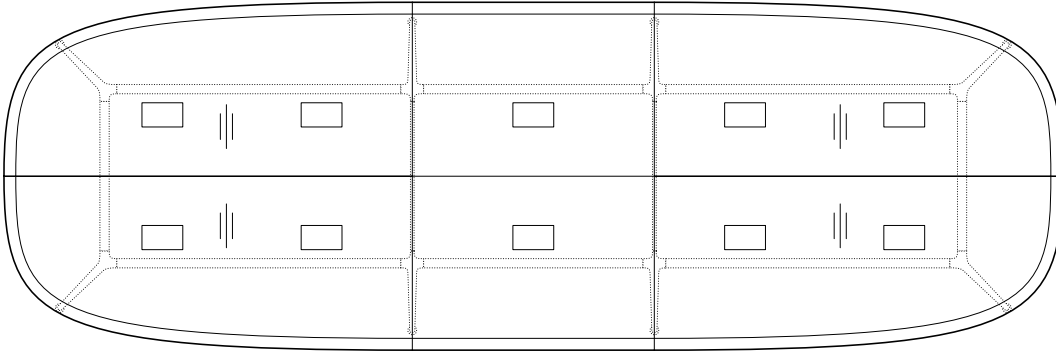
Cable channel
Vertical cable management for the table leg
300/02 10 Cable lids open sideways
300/05 10 Basic cable lids
Socket strip, strain anchor, vertical cable management, see accessories page 161

53004	53004	53004
1722	1722	1722
150570	158760	171570
18165	18165	18165
•	•	•





varnished 0	Veneer variant 1 2	Veneer variant 2 2
SEK	SEK	SEK



300/27

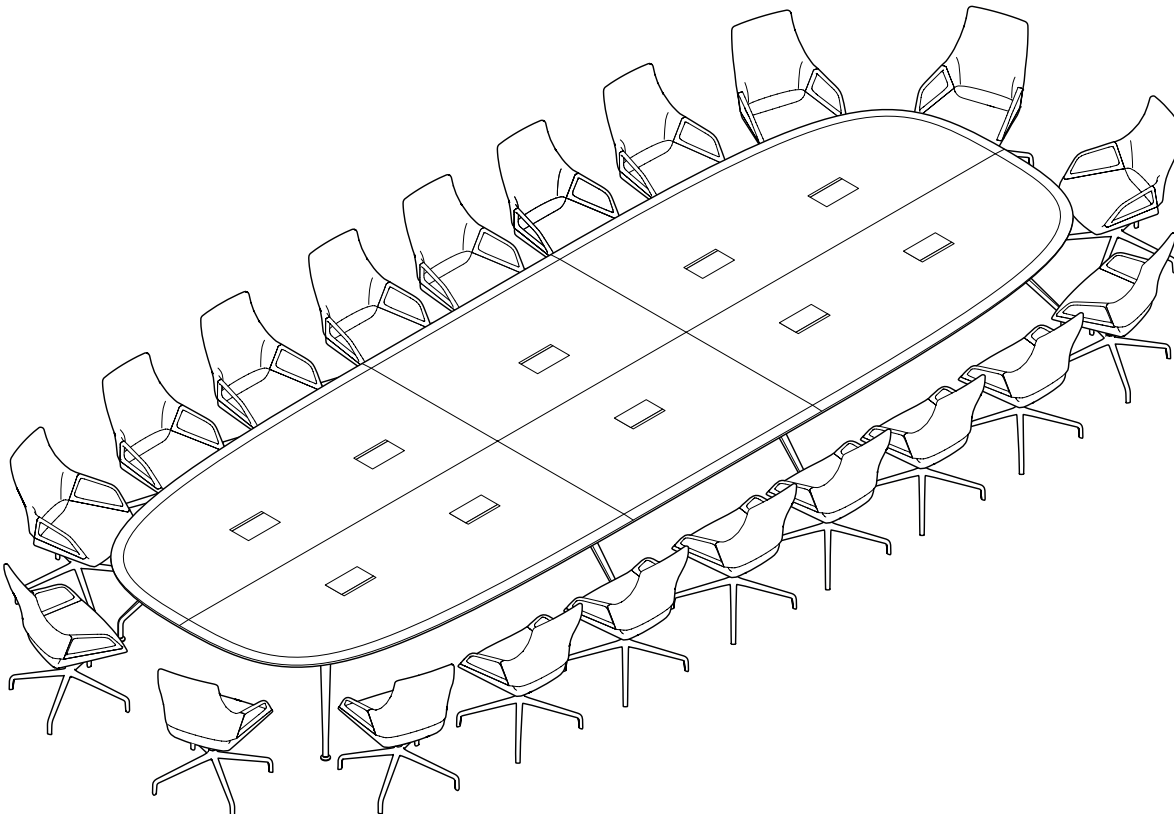
230 x 700, H 73
For 20 people,
consisting of 6 segments
Coated frame
Bright chrome-plated aluminum frame
Matte-polished chrome frame

230927	240240	248388
273084	282398	290546
293549	302862	311010

Additional charge/reduced prices

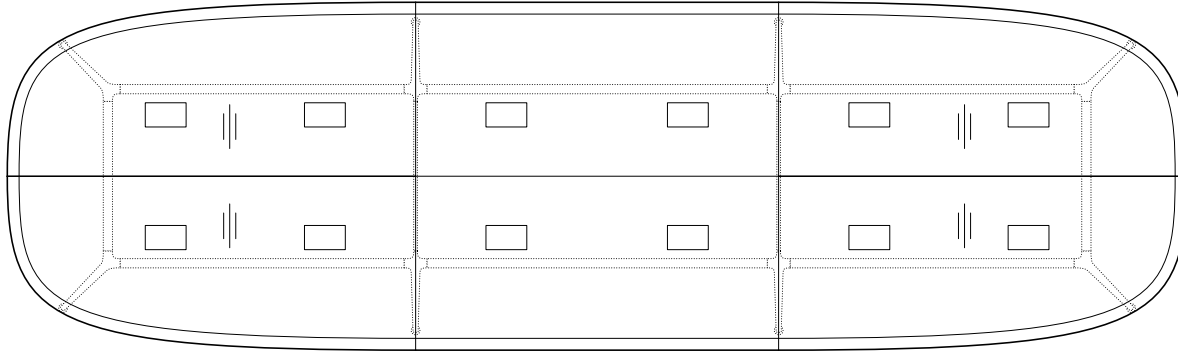
Cable channel
Vertical cable management for the table leg
300/02 10 Cable lids open sideways
300/05 10 Basic cable lids
Socket strip, strain anchor, vertical cable management, see accessories
page 161

56784	56784	56784
1722	1722	1722
150570	158760	171570
18165	18165	18165





6	2	2
varnished	Veneer variant 1	Veneer variant 2
SEK	SEK	SEK



300/28

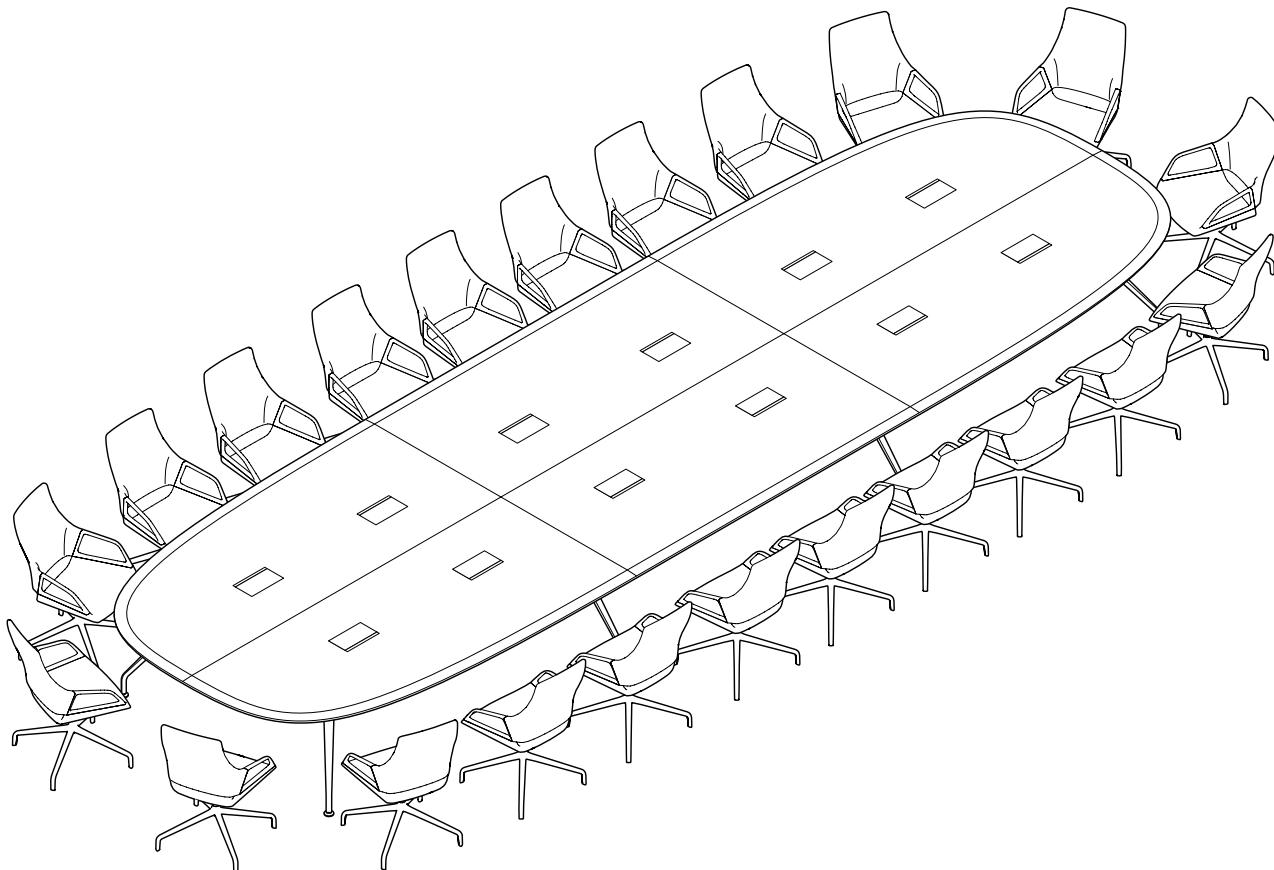
230 x 780, H 73
For 22 people,
consisting of 6 segments
Coated frame
Bright chrome-plated aluminum frame
Matte-polished chrome frame

242330	252399	262196
287343	297413	307209
310832	320901	330698

Additional charge/reduced prices

Cable channel
Vertical cable management for the table leg
300/02 12 Cable lids open sideways
300/05 12 Basic cable lids
Socket strip, strain anchor, vertical cable management, see accessories page 161

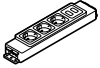
58580	58580	58580
1722	1722	1722
180684	190512	205884
21798	21798	21798
•	•	•





SEK

Socket strip



300/03

with insertion plates and strain anchor*, with 4 modules, 3 x power supply modules, 1 x data module with 2 x RJ45 connectors. When ordering state local standard
When ordering state local standard
* incl. fastening material and supply lead for electricity (300 cm)

4085

Socket strip

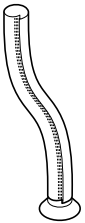


300/04

with insertion plates and strain anchor*, with 4 modules, 2 x power supply modules, 1 x data module with 2 x RJ45 connectors, 1 x slot with HDMI jack
When ordering please state local standard
* incl. fastening material and supply lead for electricity (300 cm)

8621

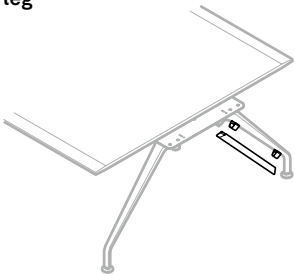
Vertical cable management



300/051

2216

Vertical cable management for the table leg



Clips for holding the plastic cables, screwed to the frame leg, detachable cover made of sheet steel coated in signal white, black with a textured matte finish or dark gray with a textured matte finish. Retrofittable on request.

1722

Strain anchor for cable channel



300/06

with insertion plate (2 items)
* incl. fastening material

609

320 Range Yonda

Design: neunzig°design



Technical details

Function

A versatile and exceptionally sustainable, multipurpose shell-structure chair range with various frame and upholstery options for meeting rooms, cafeterias, restaurants, hotel rooms and dining rooms in homes.

Frame

Four-leg frames models 320/10, 320/11, 320/12

Tubular steel frame with textured matte finish, coated in black, cream white, gray, gray-beige, emerald green, sienna red or with bright chrome plating (with environmentally friendly chromiumIII oxide). With multipurpose glides made of glide-friendly, black PA 6 (with Teflon) for soft and hard floorings. For sensitive flooring, please order with felt insert (at no additional charge).

Solid wood four-leg frame, models 320/20, 320/21, 320/22

Seat bearer made of steel plate with steel rods coated in black with a textured matte finish (RAL 9011), to fit the seat shell onto, as well as for the four legs made of FSC-compliant solid oak with an natural oiled finish. With multipurpose glides made of glide-friendly, black PA 6 (with Teflon) for soft and hard floorings. For sensitive flooring, please order with felt insert (at no additional charge).

Four-star base, models 320/30, 320/31, 320/32

Four-star base made of die-cast aluminum, coated with a textured matte finish in black cream white, gray, gray-beige, emerald green,

sienna red, or high-luster polished, with a concealed, in-built, swivel-mounted column made of two-part round steel tubing, coated black, optionally with a reset mechanism. Seat bearer made of molded flat steel with tapered steel connecting joint, coated in black with a textured matte finish (RAL 9011) or color-matched with the shell in a textured matte finish (additional charge). Optionally with a three-dimensional rocking mechanism made of springy flat steel coated black with a textured matte finish (RAL 9011) or color-matched with the shell in a textured matte finish (additional charge).

With steel base glides coated black with a textured matte finish (RAL 9011), color-matched with the shell in a textured matte finish (additional charge) with an integrated gliding surface made of Teflon-coated rubber for hard and soft floors, optionally with a felt insert for sensitive floors.

Optionally with twin-wheel swivel casters with load-dependent braking, made of black polyamide compliant with DIN EN 12529 as the standard version for carpets; with gray soft polyurethane tire for hard floors.

Five-star base, models 320/00, 320/01, 320/02

Five-star base in die-cast aluminum, coated with a textured matte finish in black, cream white, gray, gray-beige, emerald green, sienna red or high-luster polished, with a gas lift with precision-adjustable height, bright chrome-

plated or coated black with lever made of steel rod, coated black. Seat bearer made of molded flat steel with cylindrical connecting joint, coated in black with a textured matte finish (RAL 9011) or color-matched with the shell in a textured matte finish (additional charge).

Optionally with a three-dimensional rocking mechanism made of springy flat steel coated black with a textured matte finish (RAL 9011) or color-matched with the shell in a textured matte finish (additional charge).

Twin-wheel swivel casters with load-dependent braking, made of black polyamide compliant with DIN EN 12529 as the standard version for carpets; with gray soft polyurethane tire for hard floors.

Seat and backrest

Unitary, ergonomically shaped seat shell with armrests, consisting of a recyclable biocomposite (70% post-consumer recycled polypropylene, 30% waste wood fibers) food-safe, through-dyed and optionally in black, cream white, gray, gray-beige, emerald green or sienna red. Models without upholstery optionally have a felt seat cushion with non-slip coating in anthracite, a light mottled hue, anthracite, graphite, mango, verde, deep water.

Models 320/11, 320/21, 320/31 and 320/01 with seat cushioning as a replaceable, covered upholstery element made of molded plywood with molded foam made of CFC-free polyurethane foam, optionally with contoured upholstery (Y-shaped depressions).

Models 320/12, 320/22, 320/32 and 320/02 with padding on the inside as a replaceable, covered inside shell made of recyclable biocomposite (70% recycled polypropylene, 30% waste wood fibers) with molded foam made of CFC-free polyurethane foam. Leather covers have extra seat cushioning.

Please note

To ensure quality is maintained, we don't offer white leather (74/72). All other standard leather colors are possible. When exposed to ultra violet rays for long periods of time, the colors of biocomposite shell can change slightly. The subtle speckles, typical of the material, indicate the sustainable nature of the material and do not constitute grounds for complaint.

The same applies to any slight differences in color when Yonda is combined with seat shells made of biocomposite material and other chair models with seat shells made of polypropylene. There can also be slight differences in color between the biocomposite shell and the coated frames.

Felt is a natural product. Therefore, the color can differ. These differences are not grounds for complaint but underscore the material's uniqueness.

Standards

The Yonda multipurpose chairs comply with the ANSI/BIFMA X 5.1 standard.

Four-leg chairs and star bases

Base frame

- 51 Bright chrome-plated
- 72 High-luster polished aluminum
- 85 Coated gray with a textured matte finish (Pantone Cool Gray 10 C)
- 86 Coated gray-beige with a textured matte finish (Pantone 7530 C)
- 90 Coated with a black textured matte finish (RAL 9011)
- 93 Coated cream white with a textured matte finish (RAL 9001)
- 94 Coated emerald green with a textured matte finish (Pantone 5477 C)
- 95 Coated sienna red with a textured matte finish (Pantone 3523 C)



Multipurpose chair

W84 H60 D58
W44



320/10

Four-leg frame, not upholstered
Coated frame, color-matched with the shell
Bright chrome-plated frame

SEK

2667
2667

Accessories

320 Felt cushion
with non-slip coating, available in 6 colors

557

Upholstery material

				60			
				64			
				65			
				66	91		
	37	47	51	68	92	74	87
	38		54				
	SEK	SEK	SEK	SEK	SEK	SEK	SEK
	3654	3959	4158	4347	4652	5019	5765
	3654	3959	4158	4347	4652	5019	5765
	Additional charge/reduced prices						
	378	378	378	378	378	378	378

Multipurpose chair

W84 H60 D58
W44



320/11

Four-leg frame with seat cushioning
Coated frame, color-matched with the shell
Bright chrome-plated frame

Additional charge/reduced prices

Contoured upholstery

				60			
				64			
				65			
				66	91		
	38	47	51	68	92	74	87
			54				
	SEK	SEK	SEK	SEK	SEK	SEK	SEK
	5628	6185	6500	6773	7245	8873	11120
	5628	6185	6500	6773	7245	8873	11120

Multipurpose chair

W84 H60 D58
W44



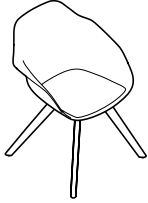
320/12

Four-leg frame with padding on the inside
Coated frame, color-matched with the shell
Bright chrome-plated frame



Multipurpose chair

84 60 60
44



320/20

Solid oak four-leg frame with a natural oiled finish, FSC-compliant not upholstered

SEK

4169

Accessories

320 Felt cushion with non-slip coating, available in 6 colors

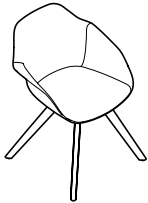
557

Upholstery material

				60			
				64			
				65			
				66	91		
	37		51	68	92	74	87
	38	47	54				

Multipurpose chair

84 60 60
44



320/21

Solid oak four-leg frame with a natural oiled finish, FSC-compliant with seat cushioning

SEK **SEK** **SEK** **SEK** **SEK** **SEK** **SEK**

5156 5460 5660 5849 6153 6521 7266

Additional charge/reduced prices

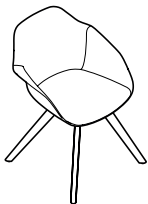
Contoured upholstery

378 378 378 378 378 378 378

				60			
				64			
				65			
				66	91		
	38		51	68	92	74	87
		47	54				

Multipurpose chair

84 60 60
44



320/22

Solid oak four-leg frame with a natural oiled finish, FSC-compliant with padding on the inside

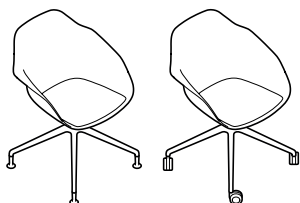
SEK **SEK** **SEK** **SEK** **SEK** **SEK** **SEK**

7130 7686 8001 8274 8747 10374 12621



Multipurpose chair

84 60 60
44



320/30

Four-star base frame on glides, swivel-mounted
Coated frame, color-matched with the shell
High-luster polished frame

SEK

4925
4925

Additional charge/reduced prices

3D suspension
Swivel-return mechanism
Casters
Frame connection and glides color-matched with the shell

557
1523
725
116

Accessories

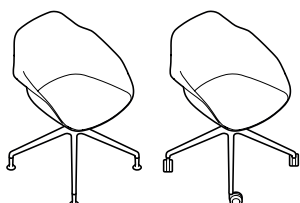
320 Felt cushion
with non-slip coating, available in 6 colors

557

Upholstery material

Multipurpose chair

84 60 60
44



320/31

Four-star base frame on glides, with seat cushioning, swivel-mounted
Coated frame, color-matched with the shell
High-luster polished frame

37 47 51 60 91
38 54 64 92 74 87

SEK SEK SEK SEK SEK SEK SEK

5912 6216 6416 6605 6909 7277 8022
5912 6216 6416 6605 6909 7277 8022

Additional charge/reduced prices

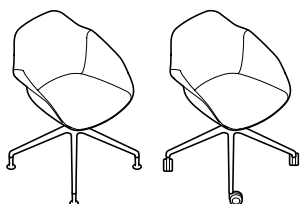
Contoured upholstery
3D suspension
Swivel-return mechanism
Casters
Frame connection and glides color-matched with the shell

378 378 378 378 378 378 378
557 557 557 557 557 557 557
1523 1523 1523 1523 1523 1523 1523
725 725 725 725 725 725 725
116 116 116 116 116 116 116

38 47 51 60 91
38 54 64 92 74 87

Multipurpose chair

84 60 60
44



320/32

Four-star base frame on glides, with padding on the inside, swivel-mounted
Coated frame, color-matched with the shell
High-luster polished frame

SEK SEK SEK SEK SEK SEK SEK

7886 8442 8757 9030 9503 11130 13377
7886 8442 8757 9030 9503 11130 13377

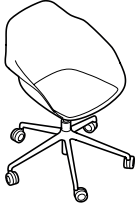
Additional charge/reduced prices

3D suspension
Swivel-return mechanism
Casters
Frame connection and glides color-matched with the shell

557 557 557 557 557 557 557
1523 1523 1523 1523 1523 1523 1523
725 725 725 725 725 725 725
116 116 116 116 116 116 116



Multipurpose chair
 81/91 67 67
 41/51



320/00
 Five-star base frame on casters, precision-adjustable height
 Coated frame, color-matched with the shell
 High-luster polished frame

SEK
 5786
 5786

Additional charge/reduced prices

3D suspension 557
 Frame connection color-matched with the shell 116

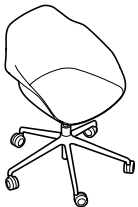
Accessories

320 Felt cushion with non-slip coating, available in 6 colors 557

Upholstery material

				60			
				64			
				65			
				66	91		
	37		51	68	92	74	87
	38	47	54				

Multipurpose chair
 81/91 67 67
 41/51



320/01
 Five-star base frame on casters, with seat cushioning, precision-adjustable height
 Coated frame, color-matched with the shell
 High-luster polished frame

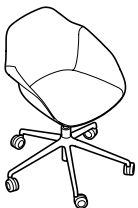
	SEK	SEK	SEK	SEK	SEK	SEK	SEK
	6773	7077	7277	7466	7770	8138	8883
	6773	7077	7277	7466	7770	8138	8883
	557	557	557	557	557	557	557
	378	378	378	378	378	378	378
	116	116	116	116	116	116	116

Additional charge/reduced prices

3D suspension 557
 Contoured upholstery 378
 Frame connection color-matched with the shell 116

				60			
				64			
				65			
				66	91		
	38	47	54	68	92	74	87

Multipurpose chair
 81/91 67 67
 41/51



320/02
 Five-star base frame on casters, with padding on the inside, precision-adjustable height
 Coated frame, color-matched with the shell
 High-luster polished frame

	SEK	SEK	SEK	SEK	SEK	SEK	SEK
	8747	9303	9618	9902	10364	11991	14238
	8747	9303	9618	9902	10364	11991	14238
	557	557	557	557	557	557	557
	116	116	116	116	116	116	116

Additional charge/reduced prices

3D suspension 557
 Frame connection color-matched with the shell 116



322 Range Yonda Lounge

Design: neunzig°design



Technical details

Function

Distinctive and comfortable lounge range in a high-quality design, consisting of chairs with three frame variants, matching upholstered stool and ottoman as well as side tables with pebble-shaped table tops. The spacious and organic shape of the fully upholstered shell has a welcoming appeal. It also offers superb comfort thanks to the armrests that are fluidly integrated into the chair, provide support at the bottom and elasticity at the top of the backrest. Ideal for receptions and lobbies, informal communication spaces, superior recreational areas and living spaces.

Lounge chair

Frame

Sled base model 322/14

Sled base made of steel rod, diameter 12 mm, with a textured matte finish and coated in black, white or with bright chrome plating (made of eco-friendly ChromiumIII oxide). Coated frames as a standard and, if required bright chrome-plated frames optionally come with multipurpose glides made of black polyamide. For sensitive flooring, please order with felt insert (at no additional charge).

Solid wood four-leg frame model 322/24

Seat bearer made of steel rods, diameter 18 mm, coated black with a textured matte finish, for mounting to the seat shell and to the four legs made of FSC-compliant solid oak with a natural oiled finish. With multipurpose glides made of glide-friendly, black PA 6 (with Teflon) for soft and hard floorings. For sensitive flooring, please order with felt insert (at no additional charge).

Four-star base model 322/34

Four-star base made of die-cast aluminum, coated in black or white with a textured matte finish or high-luster polish. With an integrated, concealed swivel-mounted column made of two pieces of round steel tubing, coated in black or white, optionally with an automatic swivel-return mechanism. Core panel made of steel, coated in black or white with a textured matte finish for mounting the upholstered shell. With multipurpose glides made of glide-friendly, black PA 6 (with

Teflon) for soft and hard floorings. For sensitive flooring, please order with felt insert (at no additional charge).

Seat and backrest

Unitary, ergonomic seat shell with integrated armrests, made of 100% ABS recycled material. Reinforced with steel to provide stability underneath the seat. Shell with CFC-free polyurethane molded foam. Replaceable covers with Y-shaped clamps in the backrest. Separate, replaceable seat cushioning with clamps as covered upholstery element made of molded plywood with molded foam made of CFC-free polyurethane, monofraction sorting possible. Upholstery element screwed on underneath the seat. Non-destructive dismantling possible.

Upholstered stool

Body made of FSC-compliant plywood attached with screws, with CFC-free polyurethane molded foam. Swivel-mounted upholstered body, with a round base made of PET fleece, 9 mm thick, up to 50% of which is made of recycled material, in anthracite and a black, through-dyed polycarbonate rotating ring attached with screws.

Ottoman

Sled base made of steel rod, diameter 12 mm, with a textured matte finish and coated in black, white or with bright chrome plating (made of eco-friendly ChromiumIII oxide). Coated frames as a standard and, if required bright chrome-plated frames optionally come with multipurpose glides made of black polyamide. For sensitive flooring, please order with felt insert (at no additional

charge). Upholstered component made of plywood, with CFC-free polyurethane molded foam. Covers replaceable.

Tables

Frame

Total height 42 or 52 cm, with sled base made of steel rod, diameter 12 mm, coated in black or white with a textured matte finish or bright chrome plating (with environmentally friendly chromiumIII oxide). Coated frames as a standard and, if required bright chrome-plated frames optionally come with multipurpose glides made of black polyamide. For sensitive flooring, please order with felt insert (at no additional charge).

Core material of table top

For table top groups 1 and 2 plywood 16 mm thick. For table top group 7 table top made of through-dyed HPL (High Pressure Laminate) 12 mm thick.

Table top group 1 – laminate

Table top thickness 17 mm variant 1 laminate (single color) from Wilkhahn's color and surface samples with color-matched plastic edging. Variant 2 soft matte laminate from Wilkhahn's color and surface samples with color-matched plastic edging. Anti-fingerprint, anti-reflective and soft-touch characteristics. Bottom of the table top the same as the surface.

Straight plastic lipping

Occo lounge chairs and ottomans

Sled (skid) base

- 51 Bright chrome-plated
- 90 Coated with a black textured matte finish (RAL9011)
- 91 Coated white with a textured matte finish (RAL9016)

Four-star base

- 72 High-luster polished aluminum
- 90 Coated with a black textured matte finish (RAL9011)
- 91 Coated white with a textured matte finish (RAL9016)

Column cover

- Coated black
- Coated black
- Coated white

Tables

Sled (skid) base

- 51 Bright chrome-plated
- 90 Coated with a black textured matte finish (RAL9011)
- 91 Coated white with a textured matte finish (RAL9016)

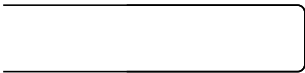


Table top group 2 – veneer

Table top thickness 17 mm variant 1 beech veneer from the Wilkhahn woodstain color samples, or oak or ash veneer from the Woodstain color samples with wood edging, largely color matching the veneer. Variant 2 maple, walnut or elm veneer from Wilkhahn's woodstain color samples with wood edging, largely color-matching the veneer. Veneer type, the veneer is always aligned with the longest side. As a standard, the veneers are made by slip-match method. Clear varnished, sealed surfaces: open-pore: oak, ash, walnut and elm veneer closed-pore: maple, beech veneer. Some specific growth features possible. Bottom of the table top the same as the surface.

Please note

For quality management reasons, we don't offer white leather (74/72). All other standard leather colors are possible.



Straight wood lipping

Table top group 7 - black/white through-dyed

Table top thickness 12 mm, made of through-dyed HPL (High Pressure Laminate) in black or white, with chamfered edging.

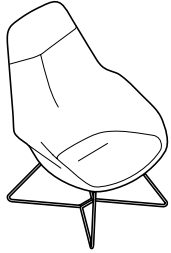


Chamfered



Lounge chair

104 79 69
32



322/14

Fully upholstered shell, with integrated seat cushion
sled base
Coated base frame
Bright chrome-plated frame

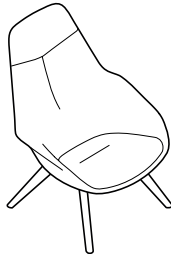
Additional charge/reduced prices

Multipurpose glides for bright chrome-plated frame (optionally with felt insert)

	38	47	51 54	60 64 65 66 68	91 92	74	87
	SEK	SEK	SEK	SEK	SEK	SEK	SEK
	17073	17189	17514	17850	19278	23909	34388
	17073	17189	17514	17850	19278	23909	34388
	147	147	147	147	147	147	147

Lounge chair

104 79 84
32



322/24

Fully upholstered shell with integrated seat cushion
Solid oak four-leg frame with a natural oiled finish

	38	47	51 54	60 64 65 66 68	91 92	74	87
	SEK	SEK	SEK	SEK	SEK	SEK	SEK
	19058	19173	19499	19835	21263	25893	36372



Lounge chair
E104 H79 H84
E32



322/34
Fully upholstered shell with integrated seat cushion
swivel-mounted, four-star base
Coated base frame
High-luster polished frame

Additional charge/reduced prices
Swivel-return mechanism

	38	47	51 54	60 64 65 66 68	91 92	74	87
	SEK	SEK	SEK	SEK	SEK	SEK	SEK
	19173	19289	19614	19950	21378	26009	36488
	19173	19289	19614	19950	21378	26009	36488
	1460	1460	1460	1460	1460	1460	1460

Ottoman
E43 H64 H50

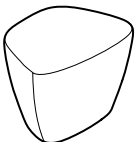


322/1
Fully upholstered sled base
Coated base frame
Bright chrome-plated frame

Additional charge/reduced prices
Multipurpose glides for bright chrome-plated frame (optionally with felt insert)

	38	47	51 54	60 64 65 66 68	91 92	74	87
	SEK	SEK	SEK	SEK	SEK	SEK	SEK
	7151	7266	7487	7707	8915	10353	14427
	7151	7266	7487	7707	8915	10353	14427
	147	147	147	147	147	147	147

Stool
E43 H57 H45



322/2
Fully upholstered swivel-mounted

	38	47	51 54	60 64 65 66 68	91 92	74	87
	SEK	SEK	SEK	SEK	SEK	SEK	SEK
	7592	7707	7928	8148	9356	10794	14984



	1	1	7	7	2	2
	Laminate variant 1	Laminate variant 2	Black through-dyed	White through-dyed	Veneer variant 1	Veneer variant 2
	SEK	SEK	SEK	SEK	SEK	SEK

Curved triangle



322/5

H 52, W 61, D 48
Side table with sled base
Coated base frame
Bright chrome-plated frame

6164	7812	6048	7487	8369	9135
6164	7812	6048	7487	8369	9135

Additional charge/reduced prices

Multipurpose glides for bright chrome-plated frame
(optionally with felt insert)

147	147	147	147	147	147
-----	-----	-----	-----	-----	-----

Curved triangle



322/6

H 42, W 82, D 64
Side table with sled base
Coated base frame
Bright chrome-plated frame

7161	8810	7046	8484	9366	10133
7161	8810	7046	8484	9366	10133

Additional charge/reduced prices

Multipurpose glides for bright chrome-plated frame
(optionally with felt insert)

147	147	147	147	147	147
-----	-----	-----	-----	-----	-----



361 Range

Ceno

Design: Läufer + Keichel



Technical details

Function

Four-leg, stackable conference chair for conference rooms, as well as high-quality restaurant and company restaurant spaces.

Frame

Frame in solid aluminum, bright chrome-plated or coated in silver satin finish or black. Black, multi-purpose glides made of plastic for all types of flooring, optionally with extra felt glides.

Seat and backrest

Seat frame in die-cast aluminum, bright chrome-plated or coated in a silver satin finish or black. Elastic backrest shell in polypropylene, reinforced with two hexagonal rods connecting the seat and back. Backrest shell fully padded with polyurethane. Seat cushion made of polyurethane molded foam; seat pan in black through-dyed plastic. Back- and seat cushion replaceable. Two-part, replaceable cover.

Armrests

Armrests in black polyamide.

Standards

The Ceno visitor chairs comply with the ANSI/BIFMA X5.1 standard.

Accessories

Optional stainless steel inline connector. Optionally for model 361, short inline connector for linking chairs without armrests and chairs with armrests alternately with chairs without armrests or model 362 long inline connector for linking chairs with armrests.

Conference chairs:

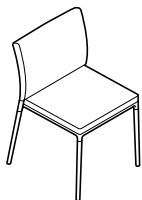
Base frame

- 51 Bright chrome-plated
 - 53 Coated black (RAL9011)
 - 60 Coated with a silver satin finish (RAL9006)
 - 90 Coated with a black textured matte finish (RAL9011)
-



Medium-height backrest

80 52 54
47



361/5

with seat and backrest upholstery,
up to 8 stackable free-standing
Aluminum coated frame

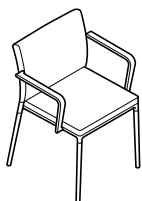
Additional charge/reduced prices

Bright chrome-plated aluminum frame

			60 64 65 66 68	92 91 92	74	87
	47	54				
	SEK	SEK	SEK	SEK	SEK	SEK
	6678	7224	7644	8264	9807	11382
	756	756	756	756	756	756

Medium-height backrest

80 58 54
47



361/6

Polyamide armrests
with upholstered seat and backrest
up to 8 stackable free-standing
Aluminum coated frame

Additional charge/reduced prices

Bright chrome-plated aluminum frame

			60 64 65 66 68	91 92	74	87
	47	51 54				
	SEK	SEK	SEK	SEK	SEK	SEK
	8201	8747	9167	9786	11330	12905
	756	756	756	756	756	756



High backrest
 85 52 54
 47



362/5
 with seat and backrest upholstery,
 up to 8 stackable free-standing
 Aluminum coated frame

Additional charge/reduced prices
 Bright chrome-plated aluminum frame

	47	51 54	60 64 65 66 68	91 92	74	87
	SEK	SEK	SEK	SEK	SEK	SEK
	7413	7959	8379	8999	10542	12117
	756	756	756	756	756	756

High backrest
 85 58 54
 47



362/6
 Polyamide armrests
 with upholstered seat and backrest,
 up to 8 stackable free-standing
 Aluminum coated frame

Additional charge/reduced prices
 Bright chrome-plated aluminum frame

	47	54	60 64 65 66 68	92 91 92	74	87
	SEK	SEK	SEK	SEK	SEK	SEK
	8936	9482	9902	10521	12065	13640
	756	756	756	756	756	756

Black plastic multipurpose glides for all types of flooring, for wooden floorings (e. g. parquet) please order with extra felt glides (at no extra charge in each case).



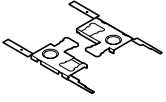
Two-wheeled cart



360
for 8 stackable conference chairs

7749

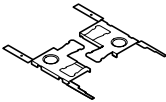
Short inline connector set



361
for linkage option without armrests and chairs with armrests alternately with chairs without armrests

504

Long inline connector set



362
for linkage option with armrests

557

440 Range Confair

Design: wiege, Fritz Frenkler, Justus Kolberg.



Technical details

Function

Mobile and compact furniture range for dynamic teams organizing the set-up of multipurpose spaces themselves.

Mobile desk

Frame

Polished die-cast aluminum star base. Oval aluminium profile column with a clear anodized finish or coated in a silver satin finish, or white or black, black or white with a textured matte finish. Black polyamide casters and glides.

Writing tablet

Birch plywood, connected to the column and can be tilted up. The front and rear edge with raised black polypropylene lipping.

Surfaces

Table top group 1 – laminate

Table top thickness 11 mm Laminate from the Wilkhahn color and surface samples. Edge/lipping natural oiled finish.

Table top group 2 – veneer

Table top thickness 11 mm Variant 1: Beech, oak or ash veneer from the Wilkhahn woodstain color samples. Variant 2: Maple, elm or walnut veneer from the Wilkhahn woodstain color samples.

Veneer type

As a standard, the veneers are made by slip-match method. Surfaces sealed with clear lacquer: open-pore: Oak, ash, walnut and elm veneer closed-pore: maple and beech veneer. Some specific growth features possible.

Accessories

Four-wheeled trolley

Side table

Frame

Polished die-cast aluminum star base. Oval aluminium profile column with a clear anodized finish or coated in a silver satin finish, or white or black, black or white with a textured matte finish. Black polyamide casters and glides.

Table top

Table top table top group 7 – black/white through-dyed

Panel thickness 12 mm Table top made of through-dyed HPL (High Pressure Laminate) in black or white, chamfered lipping.

Server

Frame

Star base in die-cast aluminum, polished or coated in a silver satin finish or black or black with a textured matte finish, or white or white with a textured matte finish, with four black polyamide twin-wheel swivel casters. Aluminum profile column and cable management covers, clear anodized or coated to match the star base. Black polypropylene handle.

Top shelf and box bracket

Black-coated, die-cast aluminum

Shelf

Sheet steel part with black textured coating.

Box

Sheet steel part with black textured coating. Sideboard body and fronts made of birch plywood.

Box with drawer

Sideboard body and fronts made of birch plywood. Sheet steel part with black textured coating. Solid beech drawer with a natural finish, on steel runners. Inside dimensions of drawer 37 x 37 cm. Sheet steel part with black textured coating.

Body group 1 – laminate

Table top thickness 12 mm Laminate from the Wilkhahn color and surface samples. Edge/lipping natural oiled finish.

Body group 2 – veneer

Table top thickness 12 mm Variant 1: Beech-, oak- or ash veneer from the Wilkhahn woodstain color samples. Variant 2: Maple, elm or walnut veneer from the Wilkhahn woodstain color samples.

Veneer type

As a standard, the veneers are made by slip-match method. Surfaces sealed with clear lacquer: open-pore: Oak, ash, walnut and elm veneer closed-pore: maple and beech veneer. Some specific growth features possible.

Important:

please observe load-bearing capacity: When load is distributed evenly, server 60 kg max., shelves, boxes each 20 kg, box with drawer 20 kg, within the drawer itself 6 kg.

Lectern

Frame

Like the server, but with two twin-wheel swivel casters and two glides made of black polyamide.

Lectern top

Birch plywood, front edge with raised black polypropylene lipping.

Surfaces

Table top group 1 – laminate

Table top thickness 11 mm Laminate from the Wilkhahn color and surface samples. Edge/lipping natural oiled finish.

Table top group 2 – veneer

Table top thickness 11 mm Variant 1: Beech, oak or ash veneer from the Wilkhahn woodstain color samples. Variant 2: Maple, elm or walnut veneer from the Wilkhahn woodstain color samples.

Veneer type

As a standard, the veneers are made by slip-match method. Surfaces sealed with clear lacquer: open-pore: Oak, ash, walnut and elm veneer closed-pore: maple and beech veneer. Some specific growth features possible.

Modesty panel

Perforated steel with a silver satin finish, or coated black, white or black with a textured matte finish, or white with a textured matte finish. Unperforated top edge for company logos (115 x 426 mm max.).

Accessories

Extra shelf, width 45 cm, depth 35 cm.

Pinboard / whiteboard

Frame

Foot sections made of die-cast aluminum, polished. Black polyamide glide Frame optionally with four lockable black casters.

Frame

Aluminum profile sides and braces, clear anodized or with a silver satin finish, or coated black.

Surface of pinboard

Covered with gray felt on both sides. With pinstrip made of anthracite-colored polyether foam.

Surface of whiteboard

One side covered with gray felt, one side with white enameled sheet steel, magnetic, can be written on with dry-wipe board marker pens and suitable as a projection screen

Accessories

Four-wheeled trolley for a whiteboard starter kit,

Flipchart

Frame

Model 442/1 Fold-up three-leg aluminum profile frame, bright chrome-plated, clear anodized or coated in black or black with a textured matte finish, or white, or white with a textured matte finish, or with a silver satin finish. Black polyamide hinge and glide. Frame optionally with three black casters, rear caster with locking device (in this version the frame can't be folded up). Writing panel made of MDF (Medium-Density Fiberboard) melamine resin bonded surface. Panel thickness 13 mm, in light gray; adjustable in three heights, can be taken off. Two pins to add standard flip chart paper, with black polyamide paper holder. Aluminum profile pen tray, clear anodized or coated to match the frame.



7	7	1	2	2
Black through-dyed	White through-dyed	Laminate	Veneer variant 1	Veneer variant 2
SEK	SEK	SEK	SEK	SEK

Mobile desk



441/1

nest into one another
Aluminum polished foot section, aluminum coated column

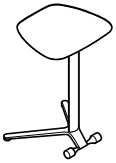
Additional charge/reduced prices

Aluminum polished foot section, aluminum clear anodized column

5765 6248 6888

158 158 158

Side table



441/2

W 47 x D 43, H 68
Foot section aluminum polished and column coated

Additional charge/reduced prices

Clear anodized column

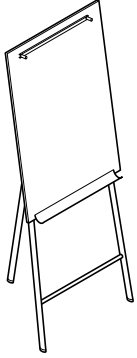
4967 5261

158 158



Flipchart

180/200 H 75 H 67



442/1

foldable
height-adjustable writing panel
Coated aluminum legs and pen tray

SEK

8537

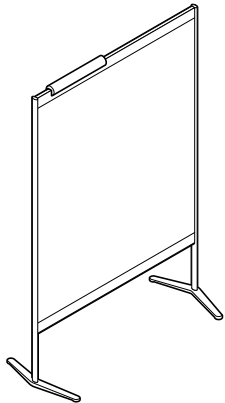
Additional charge/reduced prices

Clear anodized aluminum legs and pen tray
Bright chrome-plated aluminum legs, clear anodized aluminum pen tray
Rolling version (frame can't be folded)

473
1313
2783

Pinboard/whiteboard

190 H 125 H 54



443/1

Pinboards nest into one another,
covered with gray felt on both sides
with pinstrip model 449
Polished aluminum foot sections, coated aluminum frame

SEK

8442

Additional charge/reduced prices

Polished aluminum foot sections, clear anodized aluminum frame
Variant with casters

462
1712

443/3

Whiteboards nest into one another,
one side covered with gray felt,
one side with white enameled sheet steel, magnetic,
can be written on with drywipe pens,
suitable as a projection screen,
with pinstrip model 449
Polished aluminum foot sections, coated aluminum frame

11645

Additional charge/reduced prices

Polished aluminum foot sections, clear anodized aluminum frame
Variant with casters

462
1712

Pinstrip



449

for pinboard model 443/1 and whiteboard 443/3

SEK

221

Starter kit

451

Für whiteboard model 443/3 consisting of:
10 magnets Ø 30 mm (2 colors),
4 board marker pens (4 colors), can be dry-wiped,
1 magnetic pen holder,
1 magnetic board eraser,
10 board eraser wipes for board eraser,
1 bottle of board cleaner

SEK

1313

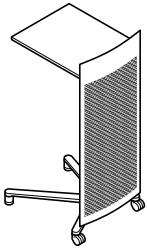
Confair
Lectern
 Server for catering/presentation purposes

Table top group



1	2	2
Laminate	Veneer variant 1	Veneer variant 2
SEK	SEK	SEK

Lectern



448/9
 with coated modesty panel
 Coated aluminum star base and column

20927 21389 21851

Additional charge/reduced prices
 Polished aluminum star base, aluminum clear anodized column

819 819 819

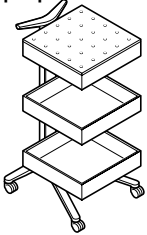
Shelf



448
 for lectern model 448/9,
 Width 45, depth 35

3791 3948 4410

Server for catering/presentation purposes



446/3
 1 box with drawer,
 2 open boxes
 Coated aluminum star base and column

24339 25725 27615

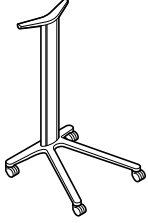
Additional charge/reduced prices
 Polished aluminum star base, aluminum clear anodized column

819 819 819

Important: please observe load-bearing capacity: When load is distributed evenly, server 60 kg max. Shelves, open boxes and cable management box 20 kg each, box with drawer 20 kg, 6 kg for each shelf.



Server frame



445/00

Height 96
Coated aluminum star base and column

SEK

6773

Additional charge/reduced prices

Polished aluminum star base, aluminum clear anodized column

819

446/00

Height 107 cm
Coated aluminum star base and column

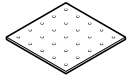
7413

Additional charge/reduced prices

Polished aluminum star base, aluminum clear anodized column

819

Shelf



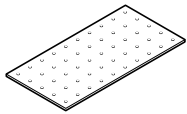
447/01

45 x 45

SEK

3150

Shelf



447/02

45 x 91

SEK

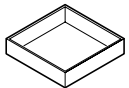
4043

Table top group

1	2	2
Laminate	Veneer variant 1	Veneer variant 2

SEK **SEK** **SEK**

Box



447/04

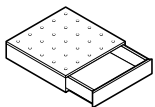
open, 45 x 45 x 10

4242

4704

5334

Box with drawer



447/07

45 x 45 x 11

8442

8904

9534

Important: please observe load-bearing capacity: When load is distributed evenly, server 60 kg max. Shelves, open boxes and cable management box 20 kg each, box with drawer 20 kg, 6 kg for each shelf.



440 Range

Confair folding table

Design: Andreas Störiko



Technical details

Function

Mobile, fold-up and linkable table range for dynamic use of conference and communication areas that users can set up themselves. Up to three meter long, barrel-shaped or rectangular tables can be opened out or collapsed in just one single step. The tables can also be linked to form conference systems using table-table connectors. Large casters allow the tables to be transported in buildings. A brake locks them in place. As a result, minimum cost and effort is required to manage conference spaces. Ideal for high-quality multipurpose conference interiors in high quality design and as a wild card in combination with the Logon table range for conference spaces with a variety of partition options, or with Timetable for sophisticated training and seminar spaces.

Frame

Foot section made of die-cast aluminum, with bright chrome plating, polished or coated with a silver satin finish, in black, white, black with a textured matte finish or white with a textured matte finish. Aluminum profile uprights and underframes, clear anodized or coated in the same colors as the foot sections. The bright chrome-plated foot sections are coated black. Upright optionally available with bright chrome plating. Connecting bar and T-shaped joint coated like the uprights and underframes, clear anodized uprights and underframes are coated with a silver satin finish. Connecting bar and T-shaped joint optionally bright chrome-plated. Lockable, black polyamide casters.

Core material of table top

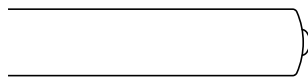
Depending on the depth of the table top, chipboard with bullnose (double) or straight wood edging all the way round with integrated impact-resilient profile made of black elastomer or with straight plastic edging all the way round. Straight version of table top without any profile along central joining edge.

Table top group 1 – laminate

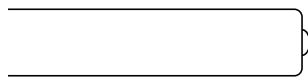
Table top thickness 26 mm

Variant 1

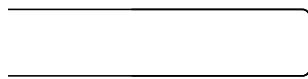
Laminate (single color) based on Wilkhahn's color and surface samples with wood edging, natural oiled finish or color-matched plastic edging.



Bullnose double wood edging with impact-resilient profile

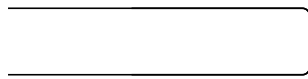


Straight wood edging with impact-resilient profile



Straight plastic edging

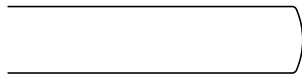
Wood decor laminate from the Wilkhahn color and surface samples with color-matched plastic edging.



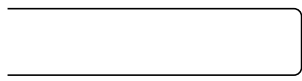
Straight plastic edging

Variant 2

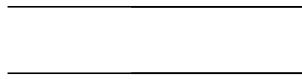
Soft matte laminate from the Wilkhahn color and surface samples with wood edging in natural oiled finish or color-matched with the plastic edging. Antireflective, antifingerprint soft touch surface.



Bullnose double wood edging with impact-resilient profile



Straight wood edging with impact-resilient profile



Straight plastic edging

Table top group 2 – veneer

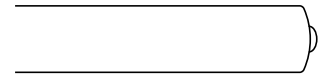
Table top thickness 26 mm

Variant 1

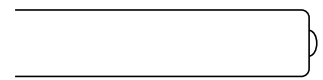
Beech, oak, or ash veneer from Wilkhahn woodstain color samples with straight wood edging, color-matched as far as possible with the veneer.

Variant 2

Maple, elm or walnut veneer veneers from the Wilkhahn woodstain color samples with edging, color-matched with the veneer as far as possible.



Bullnose double wood edging with impact-resilient profile



Straight wood edging with impact-resilient profile

Veneer type

As a standard, the veneers are made by slip-match method. Surfaces sealed with clear lacquer: open-pore: Oak, walnut and elm veneer closed-pore: Maple and beech veneer. Some specific growth features possible.

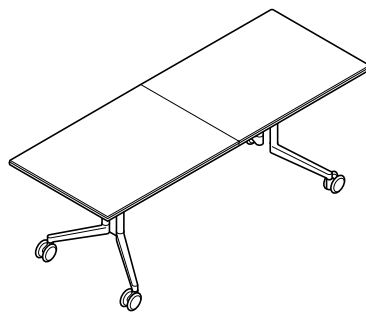
Standards

The Confair folding tables comply with the ANSI/BIFMA X 5.5 standard.

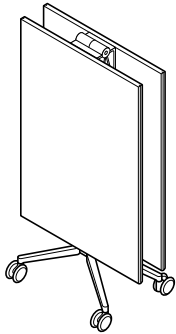
Please note

When placing repeat orders, please indicate whether your table tops have slip-matched or book-matched veneer.

Folding tables	Foot section	Upright	Connecting bar	Bearers and underframes
51	Bright chrome-plated	Coated black or bright chrome-plated	Coated black or bright chrome-plated	Coated black
52	Polished aluminum	Clear anodized aluminum	Coated with a silver satin finish	Clear anodized aluminum
48	Coated white (RAL 9016)	Coated white	Coated white	Coated white
53	Coated black (RAL 9011)	Coated black	Coated black	Coated black
60	Coated with a silver satin finish (RAL 9006)	Coated with a silver satin finish	Coated with a silver satin finish	Coated with a silver satin finish
90	Coated with a black textured matte finish (RAL 9011)	Coated with a black textured matte finish (RAL 9011)	Coated with a black textured matte finish (RAL 9011)	Coated with a black textured matte finish (RAL 9011)
91	Coated white with a textured matte finish (RAL 9016)	Coated white with a textured matte finish (RAL 9016)	Coated white with a textured matte finish (RAL 9016)	Coated white with a textured matte finish (RAL 9016)



Rectangular



440/00

cross veneer,
e. g. 110 x 260, H 73,
folded depth 110, width 56, height 160
Aluminum coated foot sections, uprights and underframes, coated connecting bar

SEK

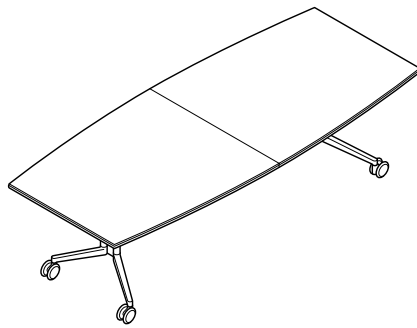
Additional charge/reduced prices

Plastic lipping all the way round for laminate variant 1 (single color) and 2 per running meter	-220
Polished aluminum foot sections, clear anodized uprights and underframes, connecting bar coated with a silver satin finish	1176
Bright chrome-plated aluminum foot sections, aluminum black coated uprights and underframes, black coated connecting bar	2415
Bright chrome-plated aluminum foot sections and uprights, aluminum black coated underframes, black coated connecting bar	5334
Bright chrome-plated aluminum foot sections and upright, aluminum black coated underframes, bright chrome-plated connecting bar	7487
Table-table-connectors model 613, metal (2 items)	777

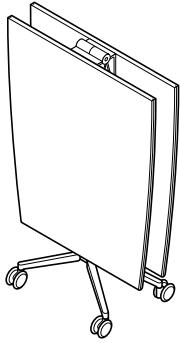
Table top group

	Width	Depth				
		90	100	105	110	120
1 Laminate variant 1	180	56952	57845	58412	59420	61100
	200	57593	58464	59451	60081	62055
	210	57887	59063	59535	60323	62234
	220	58233	59399	60113	60564	62979
	240	58874	59630	60417	61730	63830
	260	59514	59976	61079	62118	64250
	280	60155	61142	62507	63641	-
	300	60785	61541	-	-	-
1 Laminate variant 2	180	59955	61184	61950	63137	65195
	200	60953	62213	63378	64208	66602
	210	61425	63000	63693	64670	67011
	220	61929	63536	64449	65142	68009
	240	62916	64134	65153	66717	69311
	260	63903	64880	66213	67515	70172
	280	64890	66434	68093	69479	-
	300	65867	67190	-	-	-
2 Veneer variant 1	180	60386	61604	62895	63725	65268
	200	61331	62696	63767	64512	66581
	210	61814	63315	63956	64880	66969
	220	62297	63704	64659	65195	67809
	240	63242	64418	64922	67032	69626
	260	64239	65006	66654	67610	70193
	280	65153	66707	68849	69972	-
	300	66129	67284	-	-	-
2 Veneer variant 2	180	65961	67284	69090	70172	71652
	200	67368	69332	70602	71421	73952
	210	68051	70266	70833	72093	74739
	220	68765	70718	71999	72335	76146
	240	70172	71852	72650	74109	78131
	260	71568	72681	74445	75884	79055
	280	72975	75201	78435	79412	-
	300	74372	76052	-	-	-

- not available



Barrel shape



440/2

cross veneer

e. g.

90/110 x 260 H 73

folded depth 110 width 56 height 160

Aluminum coated foot sections, uprights and underframes, coated connecting bar

Additional charge/reduced prices

Plastic lipping all the way round for laminate variant 1 (single color) and 2 **per running meter**

Polished aluminum foot sections, clear anodized uprights and underframes, connecting bar coated with a silver satin finish

Bright chrome-plated aluminum foot sections, aluminum black coated uprights and underframes, black coated connecting bar

Bright chrome-plated aluminum foot sections and uprights, aluminum black coated underframes, black coated connecting bar

Bright chrome-plated aluminum foot sections and upright, aluminum black coated underframes, bright chrome-plated connecting bar

SEK

-220

1176

2415

5334

7487

Table top group

	Width	Depth	
		90/110	90/120
1 Laminate variant 1	180	-	61100
	240	-	63830
	260	62118	64250
	280	-	64596
1 Laminate variant 2	180	-	65195
	240	-	69311
	260	67515	70172
	280	-	70886
2 Veneer variant 1	180	-	65268
	240	-	69626
	260	67610	70193
	280	-	70749
2 Veneer variant 2	180	-	71652
	240	-	78131
	260	75884	79055
	280	-	79989

SEK

Cable outlet



707/1

Black plastic, Ø 80 mm

462

- not available

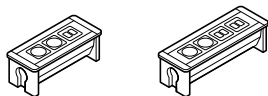




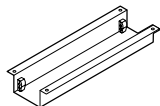
Integrated techni-station Rotate set for A1 and A3 mounting position consisting of:

SEK

Integrated techni-station rotate 701/60 or 701/70



Cable cover for techni-station



Cable clip for the table legs (2)



Integrated techni-station Rotate set 701/60 with 3 modules:

6573

2 x power supply modules (please state local standard when ordering) with supply lead, approx. 300 cm in length
1 x data module with 2 x RJ45 jacks (category 6, shielded) with permanently attached cables, approx. 350 cm in length or optionally with USB charger type A + type C with Smart IC and PD 2.0 to recharge up to two mobile devices.

Set Integrated Techni-Station Rotate 701/70 with 4 modules:

11204

2 x power supply modules (when ordering please state the local standard) with supply lead approx. 300 cm long
1 x data module with 2 x RJ45 connectors (category 6, shielded) with cables approx. 350 cm long permanently attached
1 x slot with VGA connector (15 pin D-sub) + 3.5 mm stereo jack or optionally HDMI connector with permanently attached cables, length approx. 300 cm

Additional charge/reduced prices

Techni-station with mechanism that opens by pressing the top

1008

Cable harness covered with black textile sleeving

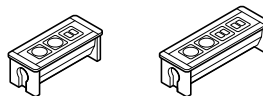
1376



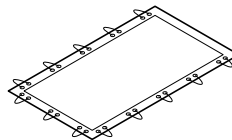
integrated techni-station Rotate set for B1 and B3 mounting position consisting of:

SEK

Integrated techni-station rotate 701/60 or 701/70



Storage mesh



Cable clip for the table legs (2)



Integrated techni-station Rotate set 701/60 with 3 modules:

9849

2 x power supply modules (please state local standard when ordering) with supply lead, approx. 300 cm in length
1 x data module with 2 x RJ45 jacks (category 6, shielded) with permanently attached cables, approx. 350 cm in length or optionally with USB charger type A + type C with Smart IC and PD 2.0 to recharge up to two mobile devices.

Integrated techni-station Rotate set 701/70 with 4 modules:

14375

2 x power supply modules (when ordering please state the local standard) with supply lead approx. 300 cm long
1 x data module with 2 x RJ45 connectors (category 6, shielded) with cables approx. 350 cm long permanently attached
1 x slot with VGA connector (15 pin D-sub) + 3.5 mm stereo jack or optionally HDMI connector with permanently attached cables, length approx. 300 cm

Additional charge/reduced prices

Techni-station with mechanism that opens by pressing the top


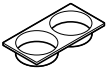








1008

Cable harness covered with black textile sleeving

1376





Integrated techni-station Compact set consisting of:	SEK	Integrated techni-station Compact Duo set consisting of:	SEK
Round or square installation frame compact		Rectangular installation frame compact duo	
			
Multimedia		Multimedia	
			
Cable clip for the table legs (2)		Cable clip for the table legs (2)	
			
Set integrated techni-station Compact 701/95 with slot for cable outlet chrome matte and surface with brushed strip/brushed profile	683	Set Integrated techni-station Compact Duo 701/96 with slot for cable outlet chrome matte, with surface with brushed strip/brushed profile*	651
Integrated techni-station Compact set 701/95 with wireless charging slot:	2919	Integrated techni-station Compact Duo set 701/96 with wireless charging slot*:	2898
1 x slot with wireless charging module (5 watt, Qi compliant) with supply lead approx. 180 cm and power supply unit		1 x slot with wireless charging module (5 watt, Qi compliant) with supply lead approx. 180 cm and power supply unit	
Integrated techni-station Compact set 701/95 with power supply module:	1281	Integrated techni-station Compact Duo set 701/96 with power supply module*:	1250
1 x power supply module (when ordering please state the local standard) with 40 cm supply lead, mod. 708/8 2 x slots with cover for optional Keystone modules		1 x power supply module (when ordering please state the local standard) with 40 cm supply lead, mod. 708/8 2 x slots with cover for optional Keystone modules	
Integrated techni-station Compact set 701/95 with power supply module and USB port	2709	Integrated techni-station Compact Duo set 701/96 with power supply module and USB port*:	2688
1 x power supply module (when ordering please state the local standard) with 40 cm supply lead, mod. 708/8 1 x USB port with Smart IC (charging current 2A max.) 1 x slot with cover for optional Keystone modules		1 x power supply module (when ordering please state the local standard) with 40 cm supply lead, mod. 708/8 1 x USB port with Smart IC (charging current 2A max.) 1 x slot with cover for optional Keystone modules	
Additional charge/reduced prices		Additional charge/reduced prices	
Keystone module RJ 45 connector (category 6) as a thru-type coupling, without cables	147	Keystone module RJ 45 jack (category 6) as a thru-type coupling, without cables	147
Keystone module, HDMI jack as a thru-type coupling, without cables	284	Keystone module, HDMI jack as a thru-type coupling, without cables	284
708/8 supply lead		708/8 supply lead	
 Length approx. 200 cm	221	 Length approx. 200 cm	221
Length approx. 300 cm	263	Length approx. 300 cm	263
Length approx. 500 cm	357	Length approx. 500 cm	357
Cable harness covered with black textile sleeving	1376	Cable harness covered with black textile sleeving	1376
			



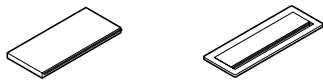
Single table portal set for Power Bar consisting of:

SEK

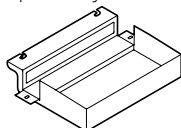
Socket strips Power Bar

SEK

Cable lid Executive or Basic



Cable channel for Power Bar mod. 704/00 and 705/00
optionally in black (RAL 9017) or white (RAL 9010)



Cable management underneath the table top with hook and loop strap on the right and left



Cable lid Executive set 150 x 300 mm

Table top group 1, laminate variant 1 and 2

13062

Table top group 2, veneer variant 1 and 2

15939

Basic cable lid set 120 x 300 mm

including fastening material for Power Bar socket strip, please order Power Bar separately

5093

Additional charge/reduced prices

Cable clip for the table legs (2)

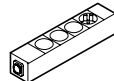


137

Mod. 704/00 Power Bar with 4 modules

1596

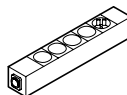
Body optionally in black or white,
with an input/output for Neutrik-powerCON® cable
1 x power supply module (when ordering please state local standard)
3 x configurable blank section



Mod. 705/00 Power Bar with 5 modules

1712

Body optionally in black or white,
with an input/output for Neutrik-powerCON® cable
1 x power supply module (when ordering please state local standard)
4 x configurable blank section



Ports for blank sections

Please note: Power and charging fields must be configured directly after one another

Power supply module (when ordering, state local standard)	221
Dual USB-A charging, 1/2 module	1344
Dual USB-C and USB-A charging, 1/2 module	2478
USB-C power charging 60W, module	3969
USB 3.0-data, Keystone module, 1/2 module	452
USB-C data (1/2 module) with approx. 30 cm cable	683
RJ45 network, CAT 6, Keystone module, 1/2 module	231
Twin network RJ45, CAT 6, Keystone module, module	378
HDMI, Keystone module, 1/2 module	882
Blanking plate, 1/2 module	32
Blanking plate, module	42

Cable

702/8 Neutrik-powerCON® supply lead

Length approx. 200 cm
Length approx. 300 cm
Length approx. 500 cm

483
578
882



702/9 Extension lead Neutrik-powerCON®

Length approx. 80 cm
Length approx. 100 cm
Length approx. 150 cm
Length approx. 200 cm

746
830
987
1124



Patch cable CAT6, length approx. 200 cm

179

Patch cable CAT6, length approx. 300 cm

210

USB 3.0 data cable, length approx. 300 cm

231

USB type C data, connecting cable, length approx. 300 cm

315

HDMI cable, length approx. 300 cm

273



Cable lid set for A1 and A3 mounting position consisting of:

SEK

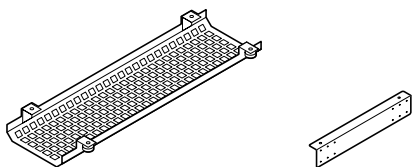
Cable lid set for M1 and M3 mounting position consisting of:

SEK

Cable lid Executive or Basic



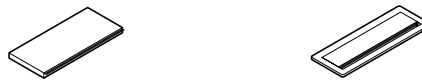
Cable basket and mount for attaching socket strips



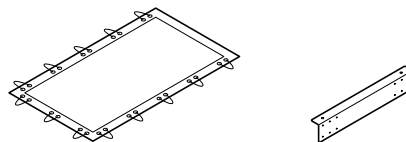
Cable clip for the table legs (2)



Cable lid Executive or Basic



Storage mesh for executive or basic cable lid for socket strip models 708/1 to 708/6



Cable clip for the table legs (2)



Executive cable lid set 150 x 300 mm

Table top group 1, laminate variant 1 and 2

12107

Table top group 2, veneer variant 1 and 2 incl. fastening material for socket strip, please order socket strip separately, can be fitted at 15° or vertically (please state angle when ordering)

14805

Basic cable lid set 120 x 300 mm

4578

incl. fastening material for socket strip, please order the socket strip separately, can be fitted vertically

Executive cable lid set 150 x 300 mm

Table top group 1, laminate variant 1 and 2

13083

Table top group 2, veneer variant 1 and 2 incl. fastening material for socket strip, please order socket strip separately, can be fitted at 15° or vertically (please state angle when ordering)

15824

Basic cable lid set 120 x 300 mm

5555

incl. fastening material for socket strip, please order the socket strip separately, can be fitted vertically

Additional charge/reduced prices

Cable harness covered with black textile sleeving

1376



Additional charge/reduced prices

Cable harness covered with black textile sleeving





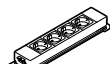

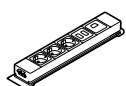
1376



Confair folding table
Built-in component sets



Socket strips for cable lid set **SEK** **Cable outlet set consisting of:** **SEK**

Mod. 708/1 socket strip with 3 modules	630	Cable outlet 707/1  Cable clip for the table legs (2)  Cable outlet set 707/1 483 Black plastic, Ø 80 mm
3 x power supply modules (when ordering state local standard) please order supply/connecting lead separately		
		
Mod. 708/2 socket strip with 3 modules:	2951	
2 x power supply modules (when ordering please state the local standard) Please order supply-/connecting cable separately 1 x data module with 2 x RJ45 connectors (category 6, shielded) with patch cables permanently connected, approx. 350 cm long or optionally with 1 x slot with 2 x USB ports (charging current 2.1A) to recharge up to two mobile devices		
		
Mod. 708/4 socket strip with 4 modules:	735	
4 x power supply modules (please state local standard when ordering) Please order supply/connecting lead separately		
		
Mod. 708/5 socket strip with 4 modules:	7518	
2 x power supply modules (when ordering please state the local standard) please order supply/connecting cable separately 1 x data module with 2 x RJ45 jacks (category 6, shielded) with permanent patch cables approx. 350 cm long permanently attached 1 x VGA jack (15 pin D-sub) + 3.5 mm stereo jack or optionally HDMI jack with permanently attached cables, length approx. 300 cm		
		
Mod. 708/6 socket strip with 5 modules:	4463	
3 x power supply modules (state local standard when ordering) Please order power supply/connecting cable separately 1 x data module with 2 x RJ45 connectors (category 6 shielded) 1 x data module with 1 x RJ45 jack (category 6 shielded) with permanently attached patch cables approx. 350 cm long		
		

Additional charge/reduced prices

Cable harness covered with black textile sleeving 1376



Additional charge/reduced prices

708/8 supply lead



Length approx. 200 cm 221
 Length approx. 300 cm 263
 Length approx. 500 cm 357

708/9 extension lead



Length approx. 200 cm 200
 Length approx. 300 cm 252

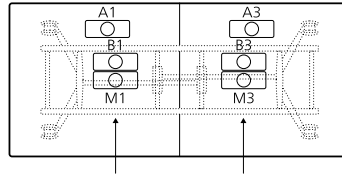
All prices include section cut out of table
 Further details from page 308

Confair folding table
Mounting positions



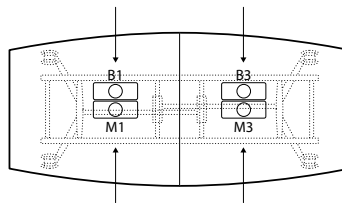
- Integrated techni-station Basic, on both sides, cable lids, integrated techni-station Compact Duo or Power Bar
- Integrated techni-station compact or cable outlet

440/00



Set	Mounting position	A1	A3	B1	B3	M1	M3
Integrated techni-station rotate 701/60 701/70		•	•	• ¹	• ¹	–	–
Cable lid Executive Basic		• ²	• ²	–	–	•	•
Integrated techni-station compact 701/95		•	•	•	•	•	•
Integrated techni-station compact duo 701/96		•	•	• ¹	• ¹	–	–
Cable outlet set 707/1		•	•	•	•	•	•
Integrated techni-station Basic, on both sides, cable lids or Power Bar		• ²	• ²	–	–	–	–

440/2

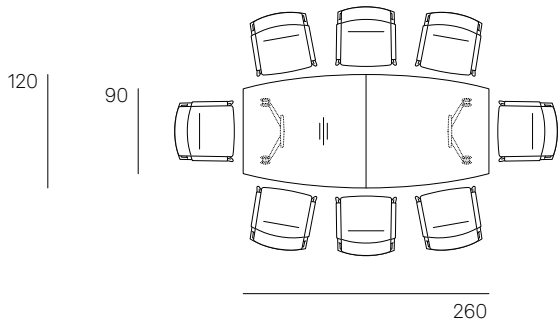


Set	Mounting position	B1	B3	M1	M3
Integrated techni-station rotate 701/60 701/70		• ³	• ³	–	–
Cable lid Executive Basic		–	–	•	•
Integrated techni-station compact 701/95		•	•	•	•
Integrated techni-station compact duo 701/96		• ³	• ³	–	–
Cable outlet set 707/1		•	•	•	•

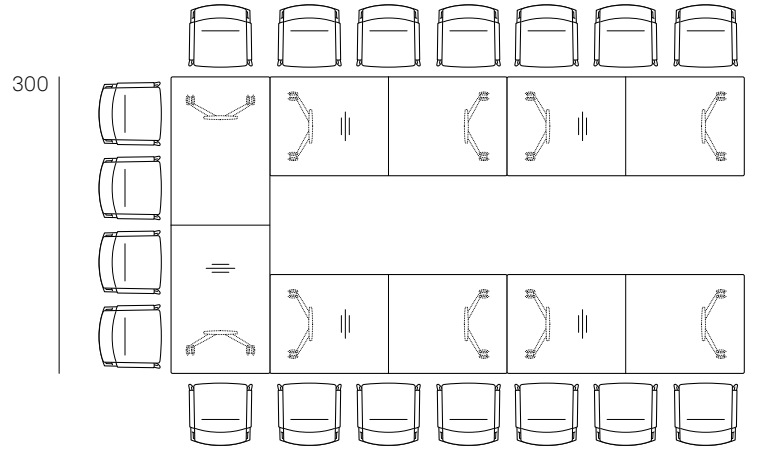
¹ from table width 210 cm
² from table depth 105 cm
³ from table width 240 cm

• available
 – not available

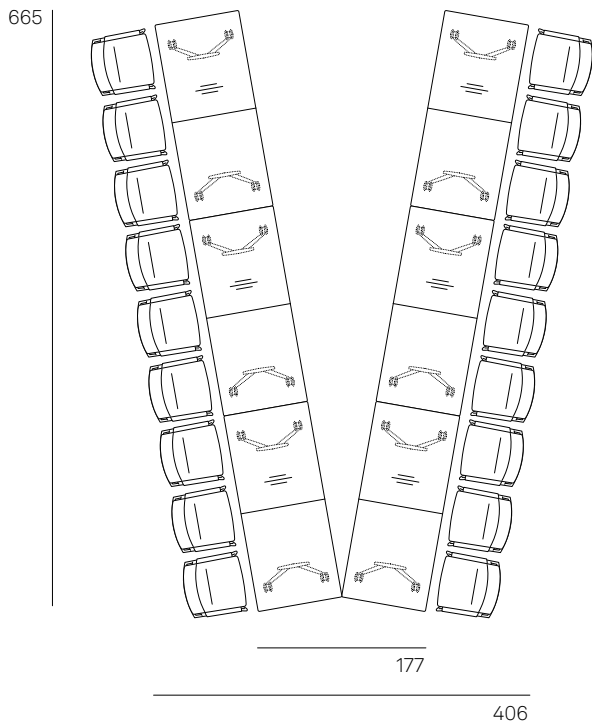
Confair folding table
Example configurations



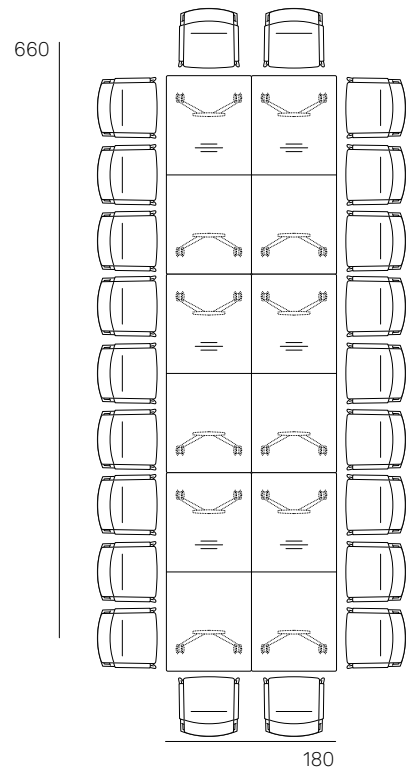
8 People
 1 x 440/2, 90/120x260



16 People
 1 x 440/00, 100x300
 4 x 440/00, 100x240



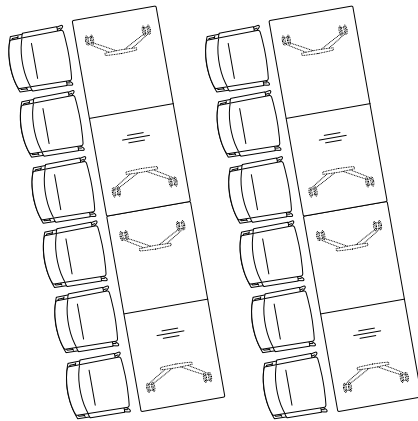
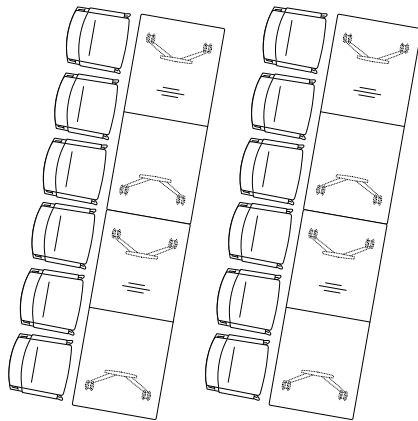
18 People
 6 x 440/00, 90x210



22 People
 6 x 440/00, 90x210



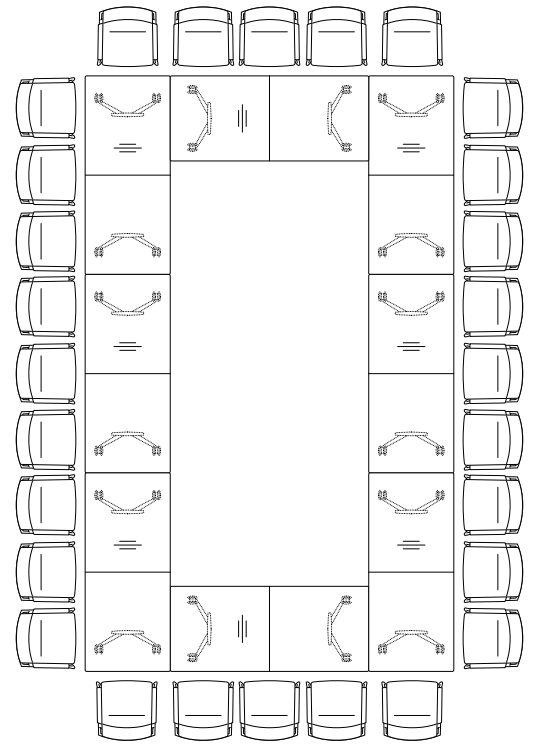
1018



375

24 People
8 x 440/00, 90x210

660



400

28 People
8 x 440/00, 90x210

460 Range mAx

Design: Andreas Störiko



Technical details

Function

The mAx folding table system offers first-class design, manual prevention of faulty handling, integrated linkage options, a self-stabilizing capability and requires just one hand to set it up. Three table foot sizes allow scalable table depths and widths to permit a broad range of design options ranging from tables in loosely arranged groups, or linked up to make rows, or arranged to form open-centered or closed conference table systems. Possible applications are versatile furnishing of conference, meeting, seminar and co-working spaces, or multipurpose restaurants and cafés

Frame

T-shaped foot, consisting of: foot section made of die-cast aluminum, coated, polished or high-luster polished with height-adjustable, non-slip multipurpose glides. Upright with pivoting mechanism made of die-cast aluminum, coated, polished or high-luster polished with integrated brace made of die-cast, high-luster polished aluminum. Pivoting mechanism with integrated stacking buffer made of black plastic and T-shaped counterbearing attached to the bottom of the table top (to insert into and lock the brace to ensure the self-stabilizing capability), made of die-cast aluminum, coated to color-match the upright or coated black if the upright is polished. In the case of system tables, also pull-out steel eyelets integrated in the folding mechanism to insert the connecting leaves into. Underframe underneath the table top made of steel profile in black.

Connecting leaves

Connecting leaves with four integrated connecting plates made of fiberglass-reinforced plastic in black and integrated steel hook to affix the system tables' metal eyelets. Knob for force-fit connections made of black fiberglass-reinforced plastic with integrated, black separator.

Core material of table top/ connecting leaf

Plywood with straight wood lipping all the way round or bullnose (double) with impact-resilient profile or with plastic lipping all the way round or plywood with bonded melamine resin surface with straight, color-matched plastic lipping all the way round.

Table top group 1 – laminate

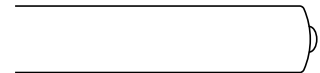
Table top thickness 26 mm

Variant 1

Laminate (single color) based on Wilkhahn's color and surface samples with wood edging, natural oiled finish, straight or optionally bullnose with an impact-resilient profile (for an additional charge)

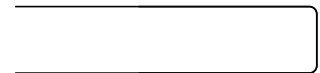


Straight wood edging



Bullnose double wood edging with impact-resilient profile

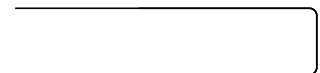
Wood decor laminate from the Wilkhahn color and surface samples with straight, color-matched plastic edging



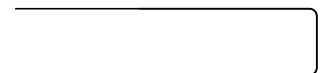
Straight plastic edging

Variant 2

Soft matte laminate from the Wilkhahn color and surface samples with wood lipping, with a natural oiled finish, straight or optionally bullnose (double) with impact-resilient profile (for an extra charge) or with color-matched plastic lipping. Anti-reflective, soft-touch surface with anti-fingerprint characteristics.



Straight plastic edging



Straight wood edging



Bullnose double wood edging with impact-resilient profile

Tables	Foot section	Upright/pivoting mechanism	Counterbearing	Underframe and plastic components
48	Coated white (RAL 9016)	Coated white	Coated white	Black
52	Polished aluminum	Coated black, white or with a silver satin finish, or polished	Coated black	Black
53	Coated black (RAL 9011)	Coated black	Coated black	Black
60	Coated with a silver satin finish (RAL 9006)	Coated with a silver satin finish	Coated with a silver satin finish	Black
72	High-luster polished aluminum	Coated black, white or with a silver satin finish, or high-luster polished	Coated black	Black



Table top group 2 – veneer

Table top thickness 26 mm

Variant 1

Beech, oak, or ash veneer from Wilkhahn woodstain color samples with straight wood lipping, color-matched as far as possible with the veneer or optionally bullnose (double) with impact-resilient profile (for an extra charge)

Variant 2

Maple, walnut or elm from the Wilkhahn woodstain color samples with straight wood lipping, color-matched with the veneer as far as possible or optionally bullnose (double) with impact-resilient profile (extra charge)



Bullnose double wood edging with impact-resilient profile



Straight wood edging

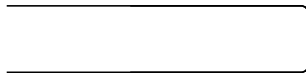
Veneer type

As a standard, the veneers are made by slip-match method. Surfaces sealed with clear lacquer: open-pore: Oak, ash, walnut and elm veneer closed-pore: maple, beech veneer. Some specific growth features possible.

When placing repeat orders, please indicate whether your table tops have slip-matched or book-matched veneer.

Table top group 5 – direct coating

Table top thickness 25 mm, plywood with bonded melamine resin surface in white, black, light gray or dark gray with color-matched, plastic lipping all the way round



Straight plastic edging

Modesty panels

Guide bar in black underneath the table top, with black, opaque fabric, height 40 cm, can be rolled up and affixed underneath the table top with hook and loop fasteners.

Table-table-connectors (optional)

Metal table-table-connectors model 613: two lockable circlips made of black coated sheet steel with 4 star-grip screws.

Standards

The mAx tables comply with the DIN EN 15372 standard.

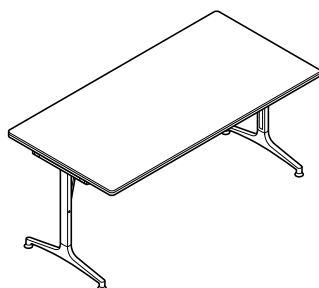


www.tuv.com
ID 1000000000

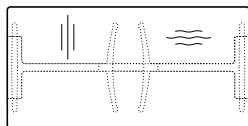


Information

Folding table's height when stacked: 107 mm Connecting leaf's stacking height: 60 mm



Rectangular



460/00

Folding table, stackable
table height 73 cm
foot section and upright coated aluminum

SEK

Additional charge/reduced prices

Polished aluminum foot section, aluminum coated upright 473
Polished aluminum foot section and upright 1586
High-luster polished aluminum foot section, aluminum coated upright 473
High-luster polished aluminum foot section and upright 1586

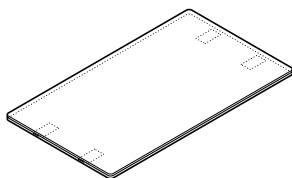
Bullnose (double) lipping all the way round with impact-resilient profile (not in the case of direct coating) **per running meter** 473

Table-table connector model 613 777

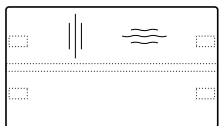
Table top group

	Width	Depth				
		60	70	75	80	90
5 Direct coating	150	8831	9398	9618	9902	10500
	160	9072	9639	9944	10238	10847
	180	9503	10164	10542	10857	11498
	200	–	10553	11025	11330	11981
	220	–	–	–	11960	12653
1 Laminate variant 1	150	9860	10406	10710	11015	11592
	160	10101	10689	11036	11319	11949
	180	10553	11235	11655	11949	12653
	200	–	11666	12149	12474	13209
	220	–	–	–	13167	13923
1 Laminate variant 2	150	11844	12705	13178	13640	14543
	160	12170	13157	13661	14154	15099
	180	12915	13997	14595	15089	16223
	200	–	14742	15425	15971	17147
	220	–	–	–	17000	18239
2 Veneer variant 1	150	14396	14795	14984	15204	15603
	160	15446	15855	16076	16286	16685
	180	15845	16286	16496	16748	17168
	200	–	16716	16989	17252	17703
	220	–	–	–	17903	18407
2 Veneer variant 2	150	15425	16023	16296	16590	17157
	160	16580	17157	17483	17766	18344
	180	16937	17567	18102	18396	18974
	200	–	18008	18627	18911	19499
	220	–	–	–	19604	20223

– not available



Square/rectangular



461/00

Connecting leaf, stackable
to extend models 460/00, 460/11 and 460/51

SEK

Additional charge/reduced prices

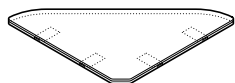
Bullnose (double) lipping all the way round with impact-resilient profile (not in the case of direct coating) **per running meter**

473

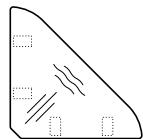
Table top group

	Width	Depth				
		60	70	75	80	90
5 Direct coating	60	4053	-	-	-	-
	70	-	4484	-	-	-
	75	-	-	4631	-	-
	80	-	-	-	4767	-
	90	-	-	-	-	5135
	120	4704	5229	5460	5723	6216
	140	4946	5460	5754	6027	6573
160	-	5733	6038	6332	6941	
1 Laminate variant 1	60	4998	-	-	-	-
	70	-	5376	-	-	-
	75	-	-	5544	-	-
	80	-	-	-	5775	-
	90	-	-	-	-	6342
	120	5712	6206	6489	6752	7361
	140	5933	6489	6815	7088	7697
160	-	6783	7130	7413	8043	
1 Laminate variant 2	60	6447	-	-	-	-
	70	-	7119	-	-	-
	75	-	-	7455	-	-
	80	-	-	-	7959	-
	90	-	-	-	-	8600
	120	7539	8390	8831	9314	10143
	140	7886	8799	9293	9776	10647
160	-	9251	9755	10248	11193	
2 Veneer variant 1	60	9650	-	-	-	-
	70	-	9933	-	-	-
	75	-	-	10038	-	-
	80	-	-	-	10175	-
	90	-	-	-	-	10437
	120	11162	11120	11288	11498	11834
	140	11540	11540	11718	11918	12306
160	-	11949	12170	12380	12779	
2 Veneer variant 2	60	10143	-	-	-	-
	70	-	10437	-	-	-
	75	-	-	10584	-	-
	80	-	-	-	10889	-
	90	-	-	-	-	11130
	120	11666	12117	12306	12611	13062
	140	12159	12684	12926	13241	13745
160	-	13251	13577	13850	14438	

- not available



Corner element 90°



461/10

Connecting leaf, stackable
to extend models 460/00 and 460/11

SEK

Additional charge/reduced prices

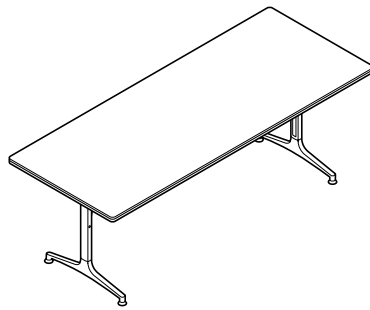
Bullnose (double) lipping all the way round with impact-resilient profile (not in the case of direct coating) **per running meter**

473

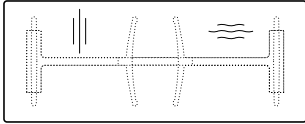
Table top group

	Width	Depth				
		60	70	75	80	90
5 Direct coating	95	5933	-	-	-	-
	109	-	6363	-	-	-
	116	-	-	6510	-	-
	123	-	-	-	6647	-
	137	-	-	-	-	7014
1 Laminate variant 1	95	7109	-	-	-	-
	109	-	7476	-	-	-
	116	-	-	7665	-	-
	123	-	-	-	7896	-
	137	-	-	-	-	8421
1 Laminate variant 2	95	8579	-	-	-	-
	109	-	9240	-	-	-
	116	-	-	9587	-	-
	123	-	-	-	10080	-
	137	-	-	-	-	10710
2 Veneer variant 1	95	11781	-	-	-	-
	109	-	12023	-	-	-
	116	-	-	12170	-	-
	123	-	-	-	12306	-
	137	-	-	-	-	12527
2 Veneer variant 2	95	12275	-	-	-	-
	109	-	12527	-	-	-
	116	-	-	12705	-	-
	123	-	-	-	12989	-
	137	-	-	-	-	13262

- not available



Rectangular



462/00

Folding table, stackable
table height 73 cm
foot section and upright coated aluminum

SEK

Additional charge/reduced prices

Polished aluminum foot section, aluminum coated upright 473
 Polished aluminum foot section and upright 1586
 High-luster polished aluminum foot section, aluminum coated upright 473
 High-luster polished aluminum foot section and upright 1586

Bullnose (double) lipping all the way round with impact-resilient profile (not in the case of direct coating) **per running meter** 473

Table-table connector model 613 777

Table top group

	Width	Depth				
		60	70	75	80	90
5 Direct coating	180	9503	10164	10542	10857	11498
	200	–	10553	11025	11330	11981
	220	–	–	–	11960	12653
1 Laminate variant 1	180	10553	11235	11655	11949	12653
	200	–	11666	12149	12474	13209
	220	–	–	–	13167	13923
1 Laminate variant 2	180	12915	13997	14595	15089	16223
	200	–	14742	15425	15971	17147
	220	–	–	–	17000	18239
2 Veneer variant 1	180	15845	16286	16496	16748	17168
	200	–	16716	16989	17252	17703
	220	–	–	–	17903	18407
2 Veneer variant 2	180	16937	17567	18102	18396	18974
	200	–	18008	18627	18911	19499
	220	–	–	–	19604	20223

– not available

465 Range mAx light

Design: Andreas Störiko



Technical details

Function

The mAx light folding table system with its lightweight table top offers first-class design, self-stabilizing capabilities, manual prevention of faulty handling, integrated linkage options and requires just one hand to set it up. Three table foot sizes allow scalable table depths and widths to permit a broad range of design options ranging from tables in loosely arranged groups, or linked up to make rows, or arranged to form open-centered or closed conference table systems. Possible applications are versatile furnishing of conference, meeting, seminar and co-working spaces, or multipurpose restaurants and cafés

Frame

T-shaped foot, consisting of: foot section made of die-cast aluminum, coated, polished or high-luster polished with height-adjustable, non-slip multipurpose glides. Upright with pivoting mechanism made of die-cast aluminum, coated, polished or high-luster polished with integrated brace made of die-cast, high-luster polished aluminum. Pivoting mechanism with integrated stacking buffer made of black plastic and T-shaped counterbearing attached to the bottom of the table top (to insert into and lock the brace to ensure the self-stabilizing capability), made of die-cast aluminum, coated to color-match the upright or coated black if the upright is polished. In the case of system tables, also pull-out steel eyelets integrated in the folding mechanism to insert the connecting leaves into. System tables from 200 cm table length, stand-alone tables as well as starter and end table top panels from 220 cm with an underframe underneath the table top made of steel profile in black.

Connecting leaves

Connecting leaves with four integrated connecting plates made of fiberglass-reinforced plastic in black and integrated steel hook to affix the system tables' metal eyelets. Knob for force-fit connections made of black fiberglass-reinforced plastic with integrated, black separator.

Core material of the table top/ connecting leaf

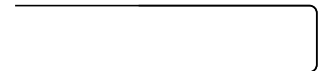
Lightweight table top with finger jointed middle section made of fast-growing lightweight wood with plastic lipping all the way round, straight or with wood lipping, straight or bullnose (double) with impact-resilient profile or with chamfered lipping (in the case of system tables with linkage option on both sides and connecting leaves with chamfered lipping on the long edges, straight joining edges, in the case of starter and end table top panels, chamfered lipping on three sides, straight joining edge, in the case of stand-alone tables chamfered lipping all the way round)

Table top group 1 – laminate

Table top thickness 30 mm

Variant 1

Laminate (single color) based on Wilkhahn's color and surface samples with wood edging, natural oiled finish, straight or optionally bullnose with an impact-resilient profile (for an additional charge)

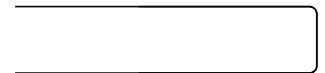


Straight wood edging



Bullnose double wood edging with impact-resilient profile

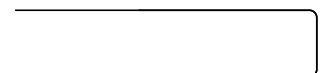
Wood decor laminate from the Wilkhahn color and surface samples with straight, color-matched plastic edging



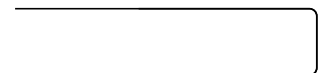
Straight plastic edging

Variant 2

Soft matte laminate from the Wilkhahn color and surface samples with wood lipping, with a natural oiled finish, straight or optionally bullnose (double) impact-resilient profile (for an extra charge) with color-matched plastic lipping. Anti-reflective, soft-touch surface with anti-fingerprint characteristics.



Straight plastic edging



Straight wood edging



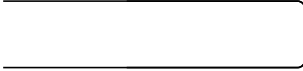
Bullnose double wood edging with impact-resilient profile

Tables	Foot section	Upright/pivoting mechanism	Counterbearing	Underframe and plastic components
48	Coated white (RAL 9016)	Coated white	Coated white	Black
52	Polished aluminum	Coated black, white or with a silver satin finish, or polished	Coated black	Black
53	Coated black (RAL 9011)	Coated black	Coated black	Black
60	Coated with a silver satin finish (RAL 9006)	Coated with a silver satin finish	Coated with a silver satin finish	Black
72	High-luster polished aluminum	Coated black, white or with a silver satin finish, or high-luster polished	Coated black	Black

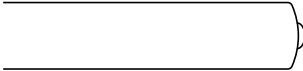


Table top group 2 – veneer

Table top thickness 30 mm



Straight wood edging



Bullnose double wood edging with impact-resilient profile



Chamfered wood edging

Variant 1

Beech, oak, or ash veneer (exception: natural ash not possible with chamfered lipping) based on Wilkhahn woodstain color samples with straight wood lipping, color-matched as far as possible with the veneer or optionally bullnose (double) with impact-resilient profile (for an extra charge)

Variant 2

Maple (exception: maple with a natural finish not possible with chamfered lipping), walnut or elm veneer from the Wilkhahn woodstain color samples with straight wood lipping, color-matched as far as possible with the veneer or optionally bullnose (double) with impact-resilient profile (for an extra charge).

Veneer type

As a standard, the veneers are made by slip-match method. Surfaces sealed with clear lacquer: open-pore: Oak, ash, walnut and elm veneer closed-pore: maple and beech veneer. Some specific growth features possible. When placing repeat orders, please indicate whether your table tops have slip-matched or book-matched veneer.

Modesty panels

Guide bar in black underneath the table top, with black, opaque fabric, height 40 cm, can be rolled up and affixed underneath the table top with hook and loop fasteners.

Table-table-connectors (optional, not possible with chamfered lipping)

Metal table-table-connectors model 613: two lockable circlips made of black coated sheet steel with 4 star-grip screws.

Standards

The mAx light tables comply with the DIN EN 15372 standard.



www.tuv.com
ID 1000000000



Information

Folding table's stacking height

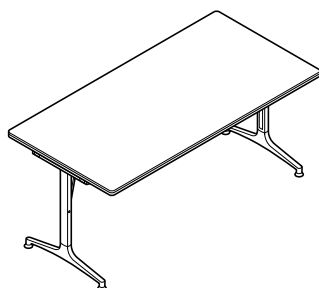
<150 cm: 120 mm

Folding table's total height when

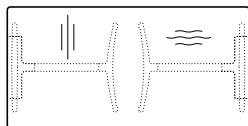
stacked \geq 150 cm: 112 mm

Connecting leaf's stacking height:

60 mm



Rectangular



465/00

Folding table, stackable
table height 73.5 cm
coated foot section, upright and underframes

SEK

Additional charge/reduced prices

Polished aluminum foot section, aluminum coated upright	473
Polished aluminum foot section and upright	1586
High-luster polished aluminum foot section, aluminum coated upright	473
High-luster polished aluminum foot section and upright	1586
Bullnose (double) lipping all the way round with impact-resilient profile per running meter	473
Chamfered lipping on the long sides* for veneer variant 1 per running meter	641
Chamfered lipping on the long sides* for veneer variant 2 per running meter	788

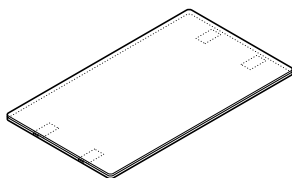
Table-table connector model 613

777

Table top group

	Width	Depth					
		45	60	70	75	80	90
1 Laminate variant 1	120	11529	11687	11844	12222	12642	13451
	130	11624	11970	12285	12758	13188	13965
	140	11750	12222	12758	13251	13713	14490
	150	12002	12474	13220	13776	14165	14910
	160	12243	12747	13650	14291	14658	15446
	180	–	13262	14522	15309	15677	16580
	200	–	–	15120	15971	16475	17472
	220	–	–	–	–	17441	18459
1 Laminate variant 2	120	12758	13325	13724	14259	14784	15876
	130	12968	13713	14354	14931	15540	16611
	140	13188	14144	14931	15624	16233	17294
	150	13514	14490	15572	16328	16884	17955
	160	13892	14889	16191	17000	17525	18648
	180	–	15687	17357	18344	18900	20192
	200	–	–	18281	19373	20087	21515
	220	–	–	–	–	21410	22932
2 Veneer variant 1	120	15887	16034	16118	16611	16874	17283
	130	16506	16979	17283	17787	18081	18564
	140	16685	17136	17462	17976	18239	18753
	150	16958	17252	17735	18176	18449	19058
	160	17766	18270	18974	19478	19761	20307
	180	–	18680	19698	20297	20591	21200
	200	–	–	20297	20969	21389	22113
	220	–	–	–	–	22344	23121
2 Veneer variant 2	120	16737	16905	17126	17682	17976	18459
	130	17493	17966	18459	19058	19394	19887
	140	17745	18176	18701	19289	19646	20255
	150	18102	18386	18995	19562	19887	20664
	160	18932	19415	20307	20927	21263	22008
	180	–	19835	21021	21935	22302	23037
	200	–	–	21630	22638	23121	23972
	220	–	–	–	–	24056	24969

– not available *available from table depth 60 cm



Square/rectangular



466/00

Connecting leaf, stackable
to extend models 465/00, 465/11 and 465/51

SEK

Additional charge/reduced prices

Bullnose (double) lipping all the way round with impact-resilient profile **per running meter**

Chamfered lipping on the long sides* for veneer variant 1 **per running meter**

Chamfered lipping on the long sides* for veneer variant 2 **per running meter**

473

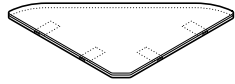
641

788

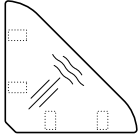
Table top group

	Width	Depth					
		45	60	70	75	80	90
1 Laminate variant 1	60	–	7277	–	–	–	–
	70	–	–	7434	–	–	–
	75	–	–	–	7686	–	–
	80	–	–	–	–	8054	–
	90	–	–	–	–	–	8663
	120	7487	8159	8736	9230	9608	10311
	140	7718	8411	9188	9723	10112	10836
	160	–	–	9629	10280	10626	11382
1 Laminate variant 2	60	–	8852	–	–	–	–
	70	–	–	9576	–	–	–
	75	–	–	–	10227	–	–
	80	–	–	–	–	10427	–
	90	–	–	–	–	–	11655
	120	8715	10038	11099	11855	12285	13430
	140	9156	10427	11624	12411	12884	14039
	160	–	–	12149	12957	13493	14627
2 Veneer variant 1	60	–	12212	–	–	–	–
	70	–	–	12359	–	–	–
	75	–	–	–	12726	–	–
	80	–	–	–	–	12957	–
	90	–	–	–	–	–	13325
	120	12254	13419	13892	14343	14553	15036
	140	12653	13839	14396	14868	15141	15645
	160	–	–	14931	15435	15729	16275
2 Veneer variant 2	60	–	12779	–	–	–	–
	70	–	–	12989	–	–	–
	75	–	–	–	13377	–	–
	80	–	–	–	–	13598	–
	90	–	–	–	–	–	13871
	120	13199	14343	14921	15467	15771	16223
	140	13703	14847	15603	16181	16485	17073
	160	–	–	16275	16895	17231	17976

– not available



Corner element 90°



466/10

Connecting leaf, stackable
to extend models 465/00 and 465/11

SEK

Additional charge/reduced prices

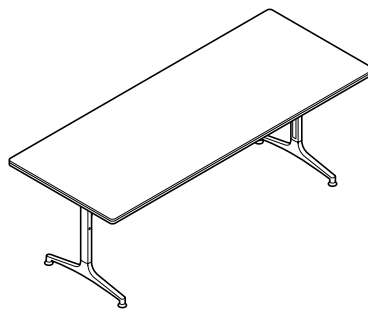
Bullnose (double) lipping all the way round with impact-resilient profile **per running meter**

473

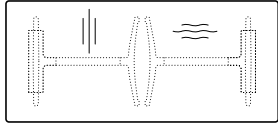
Table top group

	Width	Depth				
		60	70	75	80	90
1 Laminate variant 1	95	9461	-	-	-	-
	109	-	9618	-	-	-
	116	-	-	9870	-	-
	123	-	-	-	10238	-
	137	-	-	-	-	10847
1 Laminate variant 2	95	11036	-	-	-	-
	109	-	11760	-	-	-
	116	-	-	12411	-	-
	123	-	-	-	12611	-
	137	-	-	-	-	13839
2 Veneer variant 1	95	14396	-	-	-	-
	109	-	14543	-	-	-
	116	-	-	14910	-	-
	123	-	-	-	15141	-
	137	-	-	-	-	15509
2 Veneer variant 2	95	14963	-	-	-	-
	109	-	15173	-	-	-
	116	-	-	15561	-	-
	123	-	-	-	15782	-
	137	-	-	-	-	16055

- not available



Rectangular



467/00

Folding table, stackable
table height 73,5 cm
coated foot section, upright and underframes

SEK

Additional charge/reduced prices

Polished aluminum foot section, aluminum coated upright	473
Polished aluminum foot section and upright	1586
High-luster polished aluminum foot section, aluminum coated upright	473
High-luster polished aluminum foot section and upright	1586
Bullnose (double) lipping all the way round with impact-resilient profile per running meter	473
Chamfered lipping all the way round for veneer variant 1 per running meter	641
Chamfered lipping all the way round for veneer variant 2 per running meter	788
Table-table connector model 613 (not available with chamfered lipping)	777

Table top group

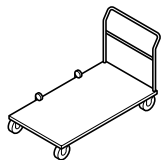
	Width	Depth				
		60	70	75	80	90
1 Laminate variant 1	180	13262	14522	15309	15677	16580
	200	–	15120	15971	16475	17472
	220	–	–	–	17441	18470
1 Laminate variant 2	180	15687	17357	18344	18900	20192
	200	–	18281	19373	20087	21515
	220	–	–	–	21410	22932
2 Veneer variant 1	180	18680	19698	20297	20591	21200
	200	–	20297	20969	21389	22113
	220	–	–	–	22344	23121
2 Veneer variant 2	180	19835	21021	21935	22302	23037
	200	–	21630	22638	23121	23982
	220	–	–	–	24056	24969

– not available *available from table depth 60 cm



SEK

Four-wheeled trolley

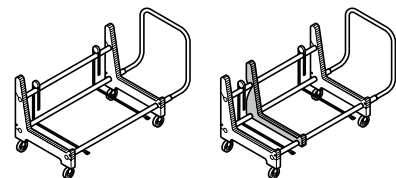


468/1

Basic
80 x 150, H 100
for 8 folding tables or 5 folding tables with 4 connecting leaves with maximum table top length of 160 cm
Felt-covered base
secured with straps

9639

Four-wheeled trolley



468/2

Comfort
85 x 190, H 100
for 6 folding tables or 4 folding tables with 3 connecting leaves with maximum table top length of 140 - 220 cm
Load-bearing areas with edge protection
secured with straps

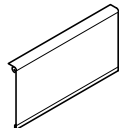
17514

Additional charge/reduced prices

Additional load-bearing area, can be shifted for smaller square, rectangular and round table tops

4011

Modesty panel



469

H40, black fabric, can be rolled up
Black-coated guide bar*

Table top width

Modesty panel width

60	58	2499
70	68	2583
75	73	2615
80	78	2646
90	88	2730
120	118	2888
130	128	2951
140	138	3056
150	148	3108
160	158	3203
180	178	3308
200	198	3549
220	218	3864
Corner element 90°	12	1922
Circular segment 60°	20	1922

* available from 60 cm table depth

Not available in combination with chamfered lipping or table-table connectors

Cable outlet




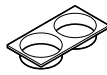




707/1

Black plastic, Ø 80 mm

462





Integrated techni-station Compact set consisting of:	SEK	Integrated techni-station Compact Duo set consisting of:	SEK
Round or square installation frame compact		Rectangular installation frame compact duo	
			
Multimedia		Multimedia	
			
Storage mesh		Storage mesh	
			
Set integrated techni-station Compact 701/95 with slot for cable outlet chrome matte and surface with brushed strip/brushed profile	1008	Set Integrated techni-station Compact Duo 701/96 with slot for cable outlet chrome matte, with surface with brushed strip/brushed profile	798
Integrated techni-station Compact set 701/95 with wireless charging slot:	3245	Integrated techni-station Compact Duo set 701/96 with wireless charging slot*:	3045
1 x slot with wireless charging module (5 watt, Qi compliant) with supply lead approx. 180 cm and power supply unit		1 x slot with wireless charging module (5 watt, Qi compliant) with supply lead approx. 180 cm and power supply unit	
Integrated techni-station Compact set 701/95 with power supply module:	1617	Integrated techni-station Compact Duo set 701/96 with power supply module*:	1365
1 x power supply module (when ordering please state the local standard) with 40 cm supply lead, mod. 708/8 2 x slots with cover for optional Keystone modules		1 x power supply module (when ordering please state the local standard) with 40 cm supply lead, mod. 708/8 2 x slots with cover for optional Keystone modules	
Integrated techni-station Compact set 701/95 with power supply module and USB port	3035	Integrated techni-station Compact Duo set 701/96 with power supply module and USB port*:	2793
1 x power supply module (when ordering please state the local standard) with 40 cm supply lead, mod. 708/8 1 x USB port with Smart IC (charging current 2A max.) 1 x slot with cover for optional Keystone modules		1 x power supply module (when ordering please state the local standard) with 40 cm supply lead, mod. 708/8 1 x USB port with Smart IC (charging current 2A max.) 1 x slot with cover for optional Keystone modules	

Additional charge/reduced prices

Keystone module, HDMI jack as a thru-type coupling, without cables	284
Keystone module RJ 45 connector (category 6) as a thru-type coupling, without cables	147
708/8 supply lead	
Length approx. 200 cm	221
Length approx. 300 cm	263
Length approx. 500 cm	357



Cable harness covered with black textile sleeving 1376



Additional charge/reduced prices

Keystone module RJ 45 jack (category 6) as a thru-type coupling, without cables	147
Keystone module, HDMI jack as a thru-type coupling, without cables	284
708/8 supply lead	
Length approx. 200 cm	221
Length approx. 300 cm	263
Length approx. 500 cm	357



Cable harness covered with black textile sleeving 1376





SEK

Techni-station Compact Add:



Techni-station Compact Add 701/97 with power supply module:

2594

1 x power supply module (when ordering please state the local standard) with approx. 270 cm supply lead
2 x slots with cover for optional Keystone modules

Additional charge/reduced prices

Keystone module RJ 45 connector (category 6) with permanently attached lead, approx. length 330 cm 945

Keystone module, HDMI jack with permanently attached lead, approx. length 270 cm 945

Cable harness covered with black textile sleeving 1376



Can be used on straight and bullnose lipping, but not with modesty panels.

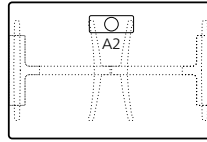


- Integrated techni-station compact duo
- Integrated techni-station compact or cable outlet

A maximum of two built-in component sets are to be integrated per table. Possible positions: Either A 1 and A 3 or A 2.

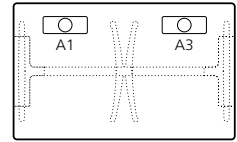
Table top width 120 – 140 cm

465/00



120 cm

465/00

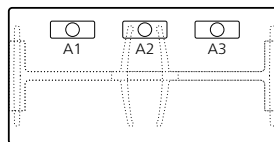


130 – 140 cm

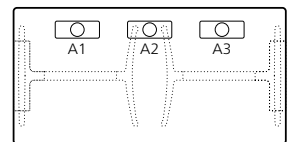
Set	Mounting position	Table top width 120 – 140 cm			Table top width 130 – 140 cm		
		A1	A2	A3	A1	A2	A3
Integrated techni-station compact 701/95		–	•	–	•	–	•
Integrated techni-station compact duo 701/96		–	•	–	•	–	•
Cable outlet 707/1		–	•	–	•	–	•

Table top width from 150 cm

460/00



465/00



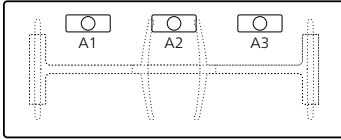
Set	Mounting position	Table top width from 150 cm			Table top width from 150 cm		
		A1	A2	A3	A1	A2	A3
Integrated techni-station compact 701/95		•	• ¹	•	•	• ¹	•
Integrated techni-station compact duo 701/96		•	• ²	•	•	• ²	•
Cable outlet 707/1		•	• ¹	•	•	• ¹	•

¹ from 160 cm table width
² from table width 180 cm
³ from table width 200 cm

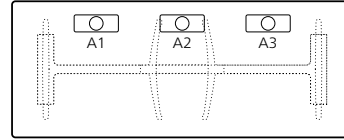
• available
 – not available



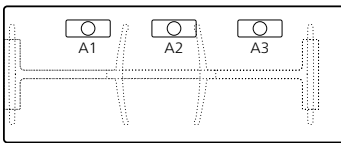
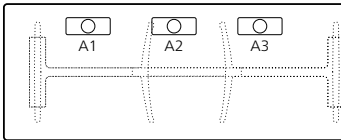
462/00



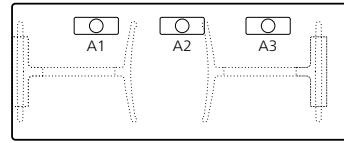
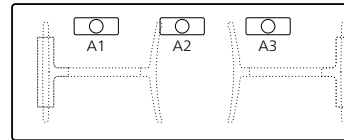
467/00



460/11
460/21



465/11
465/21

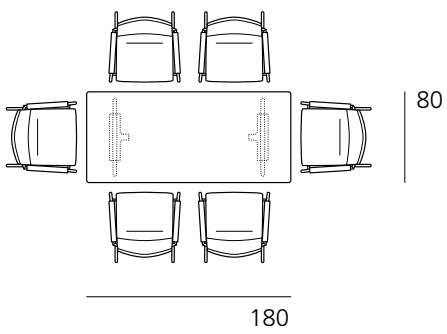


A1 A2 A3

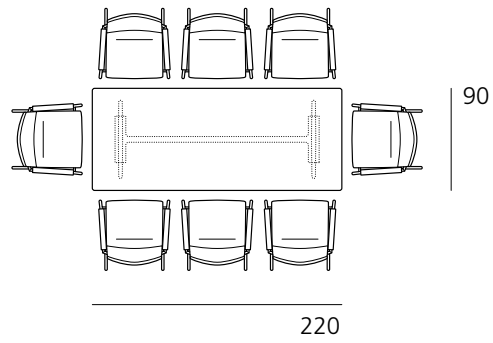
•	• ³	•
•	• ³	•
•	• ³	•

A1 A2 A3

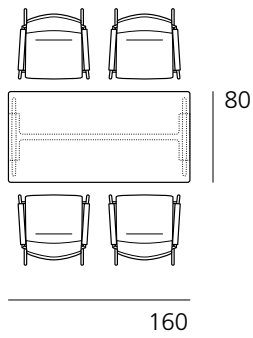
•	• ³	•
•	• ³	•
•	• ³	•



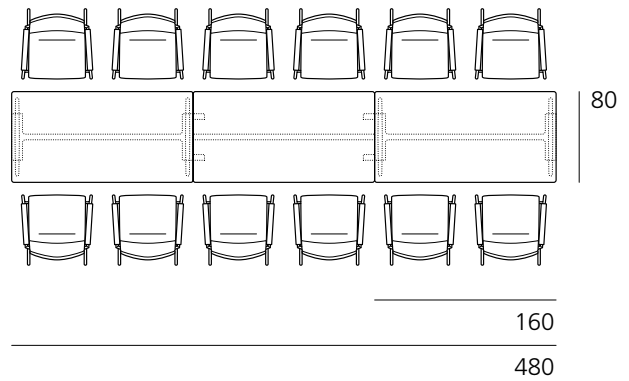
6 People
462/00 or 467/00



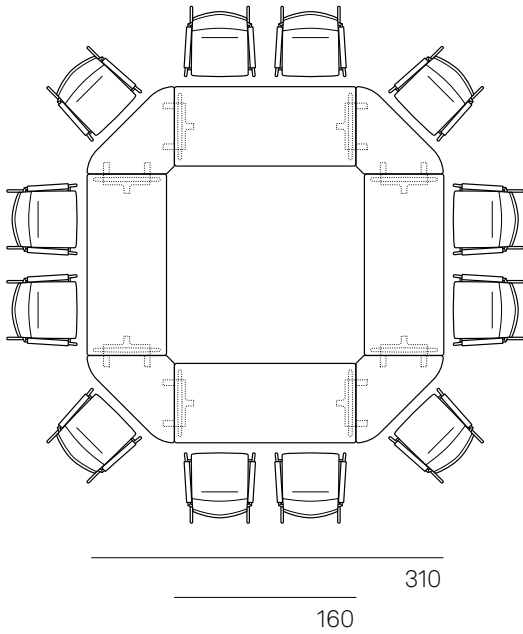
8 People
462/00 or 467/00



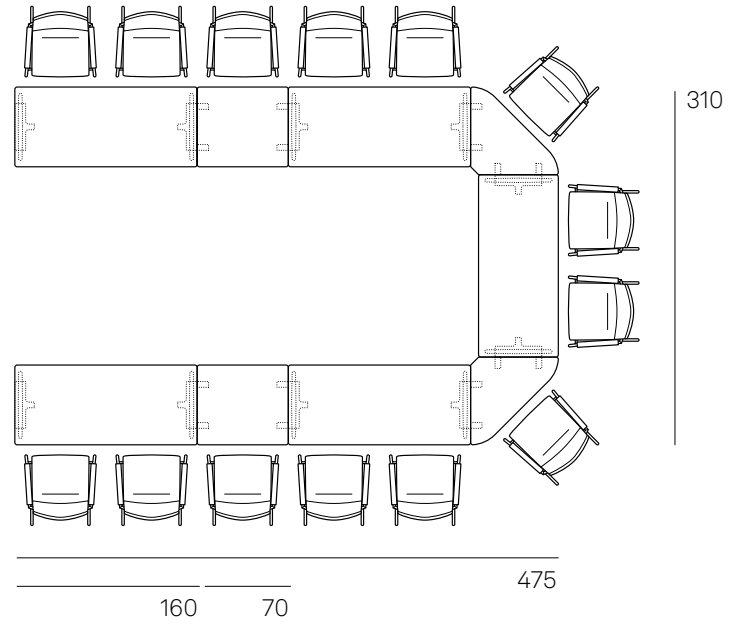
4 People
460/00 or 465/00



12 People
2 x 460/00 or 465/00
1 x 461/00 or 466/00



12 People
4 x 460/00 or 465/00, 160x70
4 x 461/10 or 466/10, 109x70/70, 90°



14 People
5 x 460/00 or 465/00, 160x70
2 x 461/00 or 466/00, 70x70
2 x 461/10 or 466/10, 109x70/70, 90°

540 Range Contas

Design: wiege, Fritz Frenkler, Anette Ponholzer



Technical details

Function

Lightweight and flexible conference table system for multipurpose conference, seminar and training spaces. It consists of stand-alone tables which are optionally foldable and stackable, and connecting leaves allowing quick, easy and tool-free linkage and configuration of the tables using a patented swivel-mounted connector plate.

Frame

Bright chrome-plated or coated Ø 38 mm round tubing legs. Glides (for folding tables with disc profiles) made of black polyamide for soft flooring (standard) and black polyurethane for hard flooring (please state when ordering). Optionally as a stackable version (integrated separator) with table legs that turn inwards and can be locked in place using a leg retaining clamp integrated in the table top. Leg retaining clamp made of black polyamide. Connector plate for tables and connecting leaves in die-cast zinc, bright chrome-plated or coated. Connecting leaves' connector plate with separator and retention mechanism. Tables fitted with table-table-connectors.

Core material of table top

Laminboard with straight, concealed lipping.

Table top group 1 – laminate

Table top thickness 34 mm Laminated from the Wilkhahn color and surface samples with beech lipping and a natural oiled finish.

Table top group 2 – veneer

Table top thickness 34 mm Variant 1: Beech, oak or ash veneer from the Wilkhahn woodstain color samples with lipping color-matched with the veneer as far as possible. Variant 2: Maple, walnut or elm veneer from the Wilkhahn woodstain color samples with lipping color-matched with the veneer as far as possible.

Veneer type

As a standard, the veneers are made by slip-match method. Surfaces sealed with clear lacquer: open-pore: Oak, ash, walnut and elm veneer closed-pore: maple and beech veneer. Some specific growth features possible.

Modesty panels

Aluminum frame, coated with a silver satin finish, covered with transparent fabric in anthracite. Black polyamide handles.

Standards

The Contas tables comply with the ANSI/BIFMA X5.5 standard.

When placing repeat orders, please indicate whether your table tops have slip-matched or book-matched veneer.

Tables

Table frame and frame profiles

51	Bright chrome-plated
53	Coated black (RAL 9011)
60	Coated with a silver satin finish (RAL 9006)

Contas
System and folding tables, panel depth 75 cm

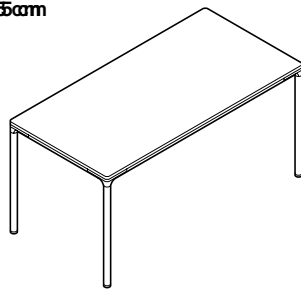
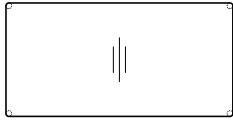


Table top group

1	2	2
Laminate	Veneer variant 1	Veneer variant 2
SEK	SEK	SEK

Rectangular



540/15
75 x 150, H 73
Aluminum coated frame

Additional charge/reduced prices
Bright chrome-plated aluminum frame
as a folding table

22208	28193	32687
5555	5555	5555
2457	2457	2457

Rectangular



540/18
75 x 180, H 73
Aluminum coated frame

Additional charge/reduced prices
Bright chrome-plated aluminum frame
as a folding table

25652	31868	36971
5765	5765	5765
2457	2457	2457

System and folding tables, panel depth 90 cm

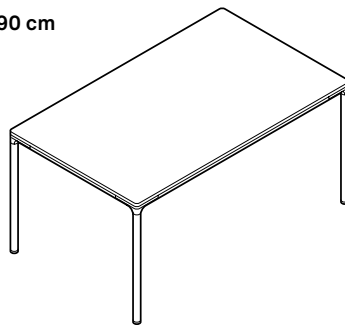
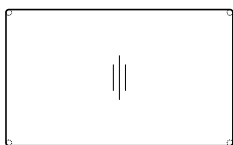


Table top group

1	2	2
Laminate	Veneer variant 1	Veneer variant 2
SEK	SEK	SEK

Rectangular



540/25
90 x 150, H 73
Aluminum coated frame

Additional charge/reduced prices
Bright chrome-plated aluminum frame
as a folding table

24612	29663	34629
5765	5765	5765
2457	2457	2457

Rectangular



540/28
90 x 180, H 73
Aluminum coated frame

Additional charge/reduced prices
Bright chrome-plated aluminum frame
as a folding table

27563	32907	38651
5975	5975	5975
2457	2457	2457

All tables come with glides for soft floorings (e. g. carpets). Please order with soft glides (at no extra charge) for hard flooring (e. g. stone, parquet). See accessories for matching modesty panels for the long and short sides.



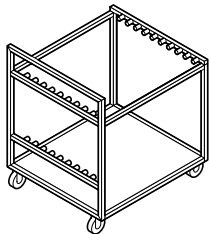
SEK

Four-wheeled trolley

546/75

to fit five folding tables 540/15 (table depth 75 cm) into

17042

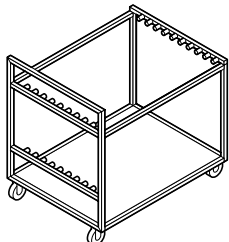


Four-wheeled trolley

546/90

to fit five folding tables 540/25 (table depth 90 cm) into

17042



Modesty panel

549/04

Length 140, H 40, for the 540/15 and 540/25 models

7896

Modesty panel

549/05

Length 170, H 40, for the 540/18 and 540/28 models

8117

Table-table connector

549/20

189





610 Range Timetable

Design: Andreas Störiko



Technical details

Function

Mobile table range with flip-top table tops and feet that turn in automatically in the process. For multi-use spaces designed for interactive and dynamic conference types in settings where people convene for meetings, workshops, projects, training courses and talks. When horizontal, the table top locks automatically and two pull rods fitted underneath release it to flip it up. The feet that turn in allow the tables to nest into one another very compactly and without staggered nesting at the sides. Ideal in combination with items from the Con-fair 440 range.

Frame

Foot section in die-cast aluminum, bright chrome-plated or polished. Uprights and underframes in tubular steel, coated in black or with a silver satin finish. Upright optionally available with bright chrome plating. Table top bearer in die-cast zinc, coated black, lockable, height adjustable, swivel casters with a black polyamide tire are the standard version for carpets; casters available with a polyurethane tire for hard floors (please specify when ordering). Models as of a 750 mm table depth have a bigger foot section and shorter uprights.

Core material of table top

Plywood with bullnose or straight wood edging all the way round and with an integrated impact-resilient profile made of black elastomer or with straight plastic edging all the way round.

Table top group 1 – laminate

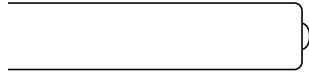
Table top thickness 26 mm

Variant 1

Laminate (single color) based on Wilkhahn's color and surface samples with wood edging, natural oiled finish or color-matched plastic edging.



Standard type: Bullnose with impact-resilient profile

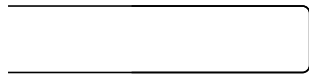


Straight edging with an impact-resilient profile



Straight plastic edging

Wood decor laminate from the Wilkhahn color and surface samples with color-matched plastic edging.



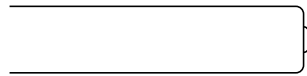
Straight plastic edging

Variant 2

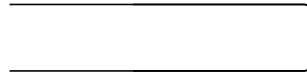
Soft matte laminate from the Wilkhahn color and surface samples with wood edging in natural oiled finish or color-matched with the plastic edging. Anti-reflective, soft-touch surface with anti-fingerprint characteristics.



Standard type: Bullnose with impact-resilient profile



Straight edging with an impact-resilient profile



Straight plastic edging

Table top group 2 – veneer

Table top thickness 26 mm



Standard type: Bullnose with impact-resilient profile



Straight edging with an impact-resilient profile

Variant 1

Beech, oak or ash veneer (exception: natural ash with chamfered edging not possible) from the Wilkhahn woodstain color samples with wood edging, color-matched as far as possible with the veneer.

Variant 2

Maple (exception: no maple with a natural finish with chamfered edging), walnut or elm veneer from the Wilkhahn woodstain color samples with wood edging, color-matched as far as possible with the veneer.

Veneer type

As a standard, the veneers are made by slip-match method. Surfaces sealed with clear lacquer: open-pore: Oak, ash, walnut and elm veneer closed-pore: Maple and beech veneer. Some specific growth features possible.

Standards

The Timetable tables comply with the ANSI/BIFMA X5.5 standard.

When placing repeat orders, please indicate whether your table tops have slip-matched or book-matched veneer.

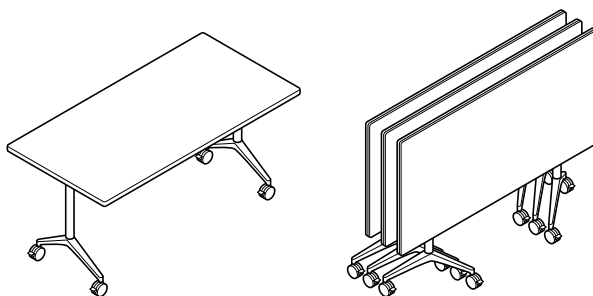
Modesty panels (underneath the table)

Aluminum frame, coated with a silver satin finish, in anthracite or covered with black fabric. Black polyamide handles.

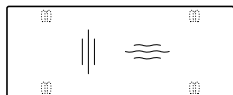
Table-table connectors (optional)

Metal table-table connectors Model 613: two lockable circlips made of black coated sheet steel with four star-grip screws and additionally for Timetable Smart: table-table connectors in plastic. Model 616: two rotatable circlips and two collets made of black through-dyed fiberglass-reinforced polyamide with washers.

Tables	Foot section	Upright and underframes	Supports
48	Coated white (RAL9016)	Coated white	Coated white
51	Bright chrome-plated	Coated black, black with a textured matte finish, white, white with a textured matte finish, or with a silver satin finish, or bright chrome plating	Coated black
52	Polished aluminum	Coated black, black with a textured matte finish, white, white with a textured matte finish, or with a silver satin finish, or bright chrome plating	Coated black
53	Coated black (RAL9011)	Coated black	Coated black
90	Coated with a black textured matte finish (RAL9011)	Coated with a black textured matte finish (RAL9011)	Coated with a black textured matte finish (RAL9011)
91	Coated white with a textured matte finish (RAL9016)	Coated white with a textured matte finish (RAL9016)	Coated white with a textured matte finish (RAL9016)



Rectangular



610/00

75 x 150, H 73 nest into one another
Polished aluminum foot section, aluminum-coated uprights and underframes

e. g. 75 x 150, H 73, nest into one another

Additional charge/reduced prices

Bright chrome-plated aluminum foot section, aluminum-coated uprights and underframes
Bright chrome-plated aluminum foot section and upright, coated aluminum underframes

Plastic lipping all the way round for laminate variant 1 (single color) and 2 **per running meter**

Aluminum coated modesty panel (length 140 cm)

Coated aluminum modesty panel (length 150 cm)

Coated aluminum modesty panel (length 160 cm)

Coated aluminum modesty panel (length 180 cm)

Table-table-connectors model 613, metal (2 items)

SEK

882
1470

-220

8663
8747
8841
8978

777

Table top group

	Width	Depth			
		60	70	75	80
1 Laminate variant 1	140	20727	21693	22733	23216
	150	21504	22712	23499	23804
	160	22292	23457	23961	24276
	180	23058	24087	24675	25074
1 Laminate variant 2	140	22397	23667	24885	25515
	150	23310	24875	25830	26282
	160	24245	25788	26450	26912
	180	25263	26681	27479	28056
2 Veneer variant 1	140	23079	24549	26009	26933
	150	24266	26261	27605	28035
	160	25410	27468	28340	28707
	180	26534	28371	29379	30020
2 Veneer variant 2	140	26072	27930	29757	31101
	150	27657	30062	32046	32477
	160	29222	31773	32613	33380
	180	30734	32897	33936	35028

SEK

Cable outlet



707/1

Black plastic, Ø 80 mm

462

All tables have casters for soft flooring (e. g. carpets). Please order with soft casters (at no extra charge) for hard flooring (e. g. stone, parquet)

612 Range

Timetable Smart

Design: Andreas Störiko



Further information
Timetable Smart

Technical details

Function

Mobile table range with flip-top table tops, which lock automatically in a horizontal and vertical position. The models are a good choice for multi-use spaces designed for interactive and dynamic conference types in settings where people convene for meetings, workshops, projects, training courses and talks. Can also accommodate complex multimedia requirements thanks to its particularly robust design and the fact that the table tops can be flipped up and locked in a vertical position. As a result, it's ideal for multipurpose areas and temporary workspaces. A horizontal pull rod underneath the table top flips it up. The integrated storage buffer allows staggered nesting of the tables at the sides. Ideal in combination with items from the Confair 440 range.

Frame

Foot section in die-cast aluminum, bright chrome-plated or polished. Uprights and underframes in tubular steel, coated in black or with a silver satin finish. Table top bearer in steel profile, draw rod in round steel tubing, coated black. Lockable, height adjustable, swivel casters with a black polyamide tire are the standard version for carpeted floors; casters available with a polyurethane tire for hard floors (please specify when ordering).

Models as of a 750 mm table depth have a bigger foot section and shorter uprights.

Core material of table top

Plywood with a bonded melamine resin surface with straight, color-matched plastic edging all the way round or optionally with plywood with bullnose or straight wood edging all the way round and with an integrated impact-resilient profile made of black elastomer or with straight plastic edging all the way round.

Table top group 1 – laminate

Table top thickness 26 mm

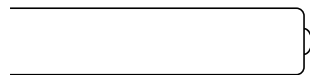
Variant 1

Laminate (single color) from the Wilkhahn color and surface samples with wood lipping, with a natural oiled finish or color-matched plastic lipping. Wood decor laminate from the Wilkhahn color and surface samples with color-matched plastic lipping.

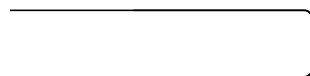
Laminate (single color) from Wilkhahn's color and surface samples with wood edging, natural oiled finish or color-matched plastic edging.



Standard type: Bullnose with impact-resilient profile



Straight edging with an impact-resilient profile



Straight plastic edging

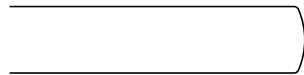
Wood decor laminate from the Wilkhahn color and surface samples with color-matched plastic edging.



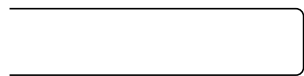
Straight plastic edging

Variant 2

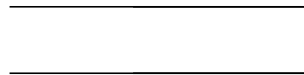
Soft matte laminate from the Wilkhahn color and surface samples with wood edging, natural oiled finish or color-matched plastic edging. Antireflective, anti-finger-print soft touch surface.



Standard type: Bullnose with impact-resilient profile



Straight edging with an impact-resilient profile



Straight plastic edging

Table top group 2 – veneer

Table top thickness 26 mm



Standard type: Bullnose with impact-resilient profile



Straight edging with an impact-resilient profile

Variant 1

Beech, oak or ash veneer (exception: natural ash with chamfered edging not possible) from the Wilkhahn woodstain color samples with wood edging, color-matched as far as possible with the veneer.

Variant 2

Maple (exception: no maple with a natural finish with chamfered edging), walnut or elm veneer from the Wilkhahn woodstain color samples with wood edging, color-matched as far as possible with the veneer.

Veneer type

As a standard, the veneers are made by slip-match method. Surfaces sealed with clear lacquer: open-pore: Oak, ash, walnut and elm veneer closed-pore: Maple and beech veneer. Some specific growth features possible.

Standards

The Timetable tables comply with the ANSI/BIFMA X5.5 standard.

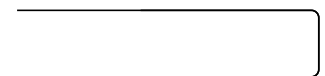
When placing repeat orders, please indicate whether your table tops have slip-matched or book-matched veneer.

Table top group 5 – bonded surface

Table top thickness 25 mm

Bonded melamine resin surface in white, light or dark gray with plastic edging to colour-match the finish.

Further finishes for the formats shown in the price list are available on request.



Straight plastic edging

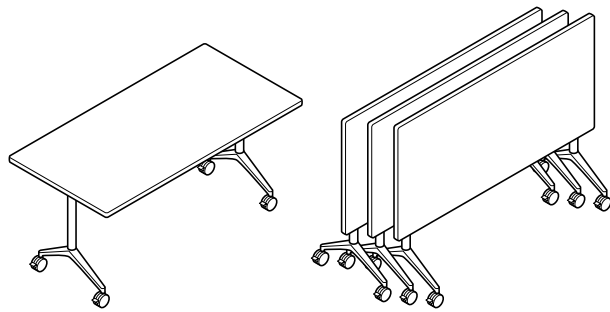
Modesty panels (underneath the table)

Aluminum frame, coated with a silver satin finish, in anthracite or covered with black fabric. Black polyamide handles.

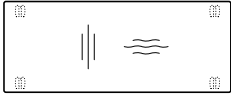
Table-table connectors (optional)

Metal table-table connectors Model 613: two lockable circlips made of black coated sheet steel with four star-grip screws and additionally for Timetable Smart: table-table connectors in plastic. Model 616: two rotatable circlips and two collets made of black through-dyed fiberglass-reinforced polyamide with washers.

Tables	Foot section	Upright and underframes	Supports
48	Coated white (RAL9016)	Coated white	Coated white
51	Bright chrome-plated	Coated black, black with a textured matte finish, white, white with a textured matte finish, or with a silver satin finish, or bright chrome plating	Coated black
52	Polished aluminum	Coated black, black with a textured matte finish, white, white with a textured matte finish, or with a silver satin finish, or bright chrome plating	Coated black
53	Coated black (RAL9011)	Coated black	Coated black
90	Coated with a black textured matte finish (RAL9011)	Coated with a black textured matte finish (RAL9011)	Coated with a black textured matte finish (RAL9011)
91	Coated white with a textured matte finish (RAL9016)	Coated white with a textured matte finish (RAL9016)	Coated white with a textured matte finish (RAL9016)



Rectangular



612/00

e.g. 75 x 150, H 73, nest into one another

Polished aluminum foot section, aluminum-coated uprights and underframes

SEK

Additional charge/reduced prices

Bright chrome-plated aluminum foot section, aluminum-coated uprights and underframes

882

Plastic lipping all the way round for laminate variant 1 (single color) and 2 **per running meter**

-220

Table-table-connectors model 613, metal (2 items)

777

Table-table-connectors model 616, plastic (2 items)

777

Table top group

	Width	Depth			
		60	70	75	80
5 Direct coating	120	10868	-	-	-
	140	-	11781	-	-
	150	11760	-	11813	-
	160	-	-	-	12023
1 Laminate variant 1	120	17661	-	-	-
	140	-	18627	-	-
	150	18596	-	18795	-
	160	-	-	-	19110
1 Laminate variant 2	120	19751	-	-	-
	140	-	21378	-	-
	150	22460	-	21893	-
	160	-	-	-	21525
2 Veneer variant 1	120	21620	-	-	-
	140	-	22554	-	-
	150	22460	-	22680	-
	160	-	-	-	23090
2 Veneer variant 2	120	25809	-	-	-
	140	-	26880	-	-
	150	26796	-	27101	-
	160	-	-	-	27867

SEK

Cable outlet



707/1

Black plastic, Ø 80 mm

462

- not available

All tables have casters for soft flooring (e.g. carpets). Please order with soft casters (at no additional charge) for hard flooring (e.g. stone, parquet)

614 Range Timetable Shift

Design: Andreas Störiko



Technical details

Function

Mobile table range with flip-top table tops, which lock automatically in a horizontal and vertical position. With an underframe connector, designed as a spacious cable channel, the models are a sound choice for multi-use spaces designed for interactive and dynamic conference types in settings where people convene for meetings, workshops and projects. The sturdy design and vertical locking mechanism mean it is suitable for multipurpose spaces, temporary workspaces and where power solutions need to be fitted in the middle. A horizontal pull rod underneath the table top flips it up. The integrated storage buffers allow compact staggered nesting of the tables at the sides. Because the frame is virtually identical, it's perfect in combination with fold-up tables from the Confair 440 range and table systems from the Logon 620 range and further items from the Confair 440 range.

Frame

Die-cast aluminum foot section, bright chrome-plated, polished or with a silver satin finish or black coating. Aluminum profile upright, clear anodized or silver satin finish, or black coating; in bright chrome-plated foot sections, coated in black. Upright optionally available with bright chrome plating. Aluminum profile underframe, with integrated cable channel, coated in silver satin finish or black depending on the foot section. Steel profile table top bearer. Round steel tubing draw rod, black or with a silver satin finish coating depending on the foot section. Lockable, height-adjustable polyamide swivel casters.

Core material of table top

Plywood with bullnose or straight wood edging all the way round and with an integrated impact-resilient profile made of black elastomer or with straight plastic edging all the way round.

Table top group 1 – laminate

Table top thickness 26 mm

Variant 1

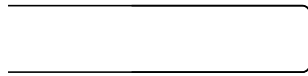
Laminate (single color) based on Wilkhahn's color and surface samples with wood edging, natural oiled finish or color-matched plastic edging.



Standard type: bullnose with impact-resilient profile



Alternatively: Straight edging with an impact-resilient profile



Straight plastic edging

Wood decor laminate from the Wilkhahn color and surface samples with color-matched plastic edging.



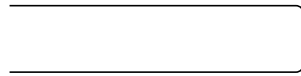
Straight plastic edging

Variant 2

Soft matte laminate from the Wilkhahn color and surface samples with wood edging in natural oiled finish or color-matched with the plastic edging. Antireflective, antifingerprint soft touch surface.



Standard type: Bullnose with impact-resilient profile



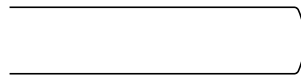
Alternatively: Straight edging with an impact-resilient profile



Straight plastic edging

Table top group 2 – veneer

Table top thickness 26 mm



Standard type: Bullnose with impact-resilient profile



Alternatively: Straight edging with impact-resilient profile

Variant 1

Beech, oak or ash veneer (exception: natural ash with chamfered edging not possible) from the Wilkhahn woodstain color samples with wood edging, color-matched as far as possible with the veneer.

Variant 2

Maple (exception: no maple with a natural finish with chamfered edging), walnut or elm veneer from the Wilkhahn woodstain color samples with wood edging, color-matched as far as possible with the veneer.

Veneer type

As a standard, the veneers are made by slip-match method. Surfaces sealed with clear lacquer: open-pore: Oak, ash, walnut and elm veneer closed-pore: Maple and beech veneer. Some specific growth features possible.

Standards

The Timetable tables comply with the DIN EN 15372 and ANSI/BIFMA X5.5 standard.



When placing repeat orders, please indicate whether your table tops have slip-matched or book-matched veneer.

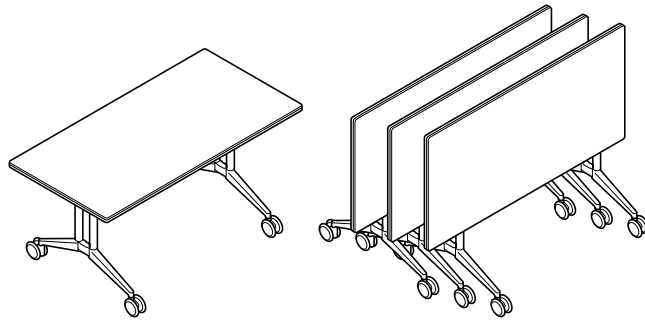
Modesty panels (underneath the table)

Aluminum frame, coated with a silver satin finish, in anthracite or covered with black fabric. Black polyamide handles.

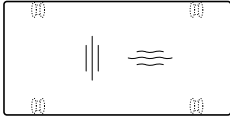
Table-table connectors (optional)

Metal table-table connectors Model 613: two lockable circlips made of black coated sheet steel with four star-grip screws and additionally for Timetable Smart: table-table connectors in plastic.

Tables	Foot section	Upright	Underframes	Supports
48	Coated white (RAL9016)	Coated white	to match the color of the upright	Coated white
51	Bright chrome-plated	Silver satin finish, coated black or black with textured matte finish or with bright chrome plating	to match the color of the upright	Coated black
52	Polished aluminum	Clear anodized aluminum	Clear anodized aluminum	Silver satin finish, coated black or black with textured matte finish
53	Coated black (RAL9011)	Coated black	to match the color of the upright	Coated black
60	Coated with a silver satin finish (RAL9006)	Coated with a silver satin finish	to match the color of the upright	Coated with a silver satin finish
90	Coated with a black textured matte finish (RAL9011)	Coated with a black textured matte finish (RAL9011)	to match the color of the upright	Coated with a black textured matte finish (RAL9011)
91	Coated white with a textured matte finish (RAL9016)	Coated white with a textured matte finish (RAL9016)	to match the color of the upright	Coated white with a textured matte finish (RAL9016)



Rectangular



614/00

e. g. 90 x 180, H 73, nest into one another
Coated aluminum foot section, coated uprights and underframes

SEK

Additional charge/reduced prices

Polished aluminum foot section, clear anodized uprights, coated underframes	1176
Bright chrome-plated aluminum foot section, uprights and underframes coated	2415
Bright chrome-plated aluminum foot section, bright chrome-plated uprights, underframes coated	5334
Plastic lipping all the way round for laminate variant 1 (single color) and 2 per running meter	-220
Coated aluminum modesty panel (length 150 cm)	9177
Coated aluminum modesty panel (length 160 cm)	9272
Coated aluminum modesty panel (length 180 cm)	9419
Coated aluminum modesty panel (length 200 cm)	9608
Coated aluminum modesty panel (length 210 cm)	11477
Table-table-connectors model 613, metal (2 items)	777

Table top group

	Width	Depth			
		80	90	100	105
1 Laminate variant 1	150	18186	18879	-	-
	160	18879	20234	21935	-
	180	20444	21504	25043	26523
	200	23100	24612	28161	29138
	210	25452	26912	30954	32099
1 Laminate variant 2	150	20675	21704	-	-
	160	21704	23289	25347	-
	180	23489	24959	28980	30660
	200	26565	28539	32613	33821
	210	29138	31133	35658	37086
2 Veneer variant 1	150	21252	22260	-	-
	160	22260	24350	26187	-
	180	24644	25578	29831	31185
	200	27479	29159	33495	35396
	210	30177	31679	36320	37674
2 Veneer variant 2	150	25463	25988	-	-
	160	25988	28886	30576	-
	180	29453	29946	34703	36057
	200	31815	34010	38850	40856
	210	35312	36677	41633	43260

SEK

Cable outlet



707/1
Black plastic, Ø 80 mm

462

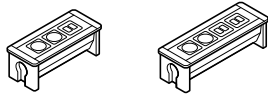
- not available

All tables have casters for soft flooring (e. g. carpets). Please order with soft casters (at no extra charge) for hard flooring (e. g. stone, parquet)

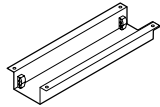


Integrated techni-station Rotate set for A2 mounting position consisting of:

Integrated techni-station rotate 701/60 or 701/70



Cable cover for techni-station



Cable holder under the table top with hook and loop strap



Cable clip for the table legs (2)



Integrated techni-station Rotate set 701/60 with 3 modules:

7844

2 x power supply modules (please state local standard when ordering) with supply lead, approx. 300 cm in length
1 x data module with 2 x RJ45 jacks (category 6, shielded) with permanently attached cables, approx. 350 cm in length or optionally with USB charger type A + type C with Smart IC and PD 2.0 to recharge up to two mobile devices.

Set Integrated Techni-Station Rotate 701/70 with 4 modules:

12369

2 x power supply modules (when ordering please state the local standard) with supply lead approx. 300 cm long
1 x data module with 2 x RJ45 connectors (category 6, shielded) with cables approx. 350 cm long permanently attached
1 x slot with VGA connector (15 pin D-sub) + 3.5 mm stereo jack or optionally HDMI connector with permanently attached cables, length approx. 300 cm

Additional charge/reduced prices

Techni-station with mechanism that opens by pressing the top 1008

Cable harness covered with black textile sleeving 1376



All prices include section cut out of table
Further details from page 308

SEK

Integrated techni-station Compact set consisting of:

SEK

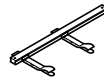
Round or square installation frame compact



Multimedia



Cable holder under the table top with hook and loop strap



Cable clip for the table legs (2)



Set integrated techni-station Compact 701/95 with slot for cable outlet chrome matte and surface with brushed strip/brushed profile

1827

Integrated techni-station Compact set 701/95 with wireless charging slot:

4085

1 x slot with wireless charging module (5 watt, Qi compliant) with supply lead approx. 180 cm and power supply unit

Integrated techni-station Compact set 701/95 with power supply module:

2426

1 x power supply module (when ordering please state the local standard) with 40 cm supply lead, mod. 708/8
2 x slots with cover for optional Keystone modules

Integrated techni-station Compact set 701/95 with power supply module and USB port

3896

1 x power supply module (when ordering please state the local standard) with 40 cm supply lead, mod. 708/8
1 x USB port with Smart IC (charging current 2A max.)
1 x slot with cover for optional Keystone modules

Additional charge/reduced prices

Keystone module, HDMI jack as a thru-type coupling, without cables 284

Keystone module RJ 45 connector (category 6) as a thru-type coupling, without cables 147

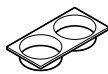


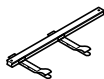
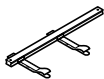


708/8 supply lead

Length approx. 200 cm 221
Length approx. 300 cm 263
Length approx. 500 cm 357

Cable harness covered with black textile sleeving 1376





Integrated techni-station Compact Duo set consisting of:	SEK	Cable outlet set consisting of:	SEK
Rectangular installation frame compact duo 		Cable outlet 707/1 	
Multimedia 			
Cable holder under the table top with hook and loop strap 		Cable holder under the table top with hook and loop strap 	
Cable clip for the table legs (2) 		Cable clip for the table legs (2) 	
Set Integrated techni-station Compact Duo 701/96 with slot for cable outlet chrome matte, with surface with brushed strip/brushed profile	1239	Cable outlet set 707/1 Black plastic, Ø 80 mm	1607
Integrated techni-station Compact Duo set 701/96 with wireless charging slot*:	3465		
1 x slot with wireless charging module (5 watt, Qi compliant) with supply lead approx. 180 cm and power supply unit			
Integrated techni-station Compact Duo set 701/96 with power supply module*:	1817		
1 x power supply module (when ordering please state the local standard) with 40 cm supply lead, mod. 708/8 2 x slots with cover for optional Keystone modules			
Integrated techni-station Compact Duo set 701/96 with power supply module and USB port*:	3266		
1 x power supply module (when ordering please state the local standard) with 40 cm supply lead, mod. 708/8 1 x USB port with Smart IC (charging current 2A max.) 1 x slot with cover for optional Keystone modules			

Additional charge/reduced prices

Keystone module RJ 45 jack (category 6) as a thru-type coupling, without cables	147
Keystone module, HDMI jack as a thru-type coupling, without cables	284
708/8 supply lead	
Length approx. 200 cm	221
Length approx. 300 cm	263
Length approx. 500 cm	357
Cable harness covered with black textile sleeving	1376



Additional charge/reduced prices


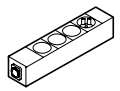
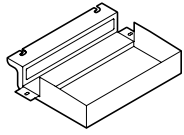
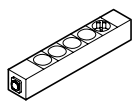




Cable harness covered with black textile sleeving	1376
---------------------------------------------------	------



* The price is for one module. Add the prices of two modules to obtain the price for a set.

All prices include section cut out of table
Further details from page 308
For individual cable outlets see accessories page 221



Single table portal set for Power Bar consisting of:	SEK	Socket strips Power Bar	SEK
Cable lid Executive or Basic 		Mod. 704/00 Power Bar with 4 modules Body optionally in black or white, with an input/output for Neutrik-powerCON® cable 1 x power supply module (when ordering please state local standard) 3 x configurable blank section 	1596
Cable channel for Power Bar mod. 704/00 and 705/00 optionally in black (RAL 9017) or white (RAL 9010) 		Mod. 705/00 Power Bar with 5 modules Body optionally in black or white, with an input/output for Neutrik-powerCON® cable 1 x power supply module (when ordering please state local standard) 4 x configurable blank section 	1712
Cable management underneath the table top with hook and loop strap on the right and left 		Ports for blank sections Please note: Power and charging fields must be configured directly after one another Power supply module (when ordering, state local standard) 221 Dual USB-A charging, 1/2 module 1344 Dual USB-C and USB-A charging, 1/2 module 2478 USB-C power charging 60W, module 3969 USB 3.0-data, Keystone module, 1/2 module 452 USB-C data (1/2 module) with approx. 30 cm cable 683 RJ45 network, CAT 6, Keystone module, 1/2 module 231 Twin network RJ45, CAT 6, Keystone module, module 378 HDMI, Keystone module, 1/2 module 882 Blanking plate, 1/2 module 32 Blanking plate, module 42	
Cable lid Executive set 150 x 300 mm Table top group 1, laminate variant 1 and 2 13062 Table top group 2, veneer variant 1 and 2 15939			
Basic cable lid set 120 x 300 mm including fastening material for Power Bar socket strip, please order Power Bar separately 5093			
Additional charge/reduced prices Bumper for bottom of the cable channel with black sponge rubber (for mod. 610) 210 Cable clip for the table legs (2) 137 			
		Cable 702/8 Neutrik-powerCON® supply lead  Length approx. 200 cm 483 Length approx. 300 cm 578 Length approx. 500 cm 882 702/9 Extension lead Neutrik-powerCON®  Length approx. 80 cm 746 Length approx. 100 cm 830 Length approx. 150 cm 987 Length approx. 200 cm 1124 Patch cable CAT6, length approx. 200 cm 179 Patch cable CAT6, length approx. 300 cm 210 USB 3.0 data cable, length approx. 300 cm 231 USB type C data, connecting cable, length approx. 300 cm 315 HDMI cable, length approx. 300 cm 273	



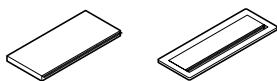
For mod. 614/00 M2 mounting position M2, single table portal set for Power Bar for positioning over the underframe, consisting of:

SEK

Socket strips Power Bar

SEK

Cable lid Executive or Basic

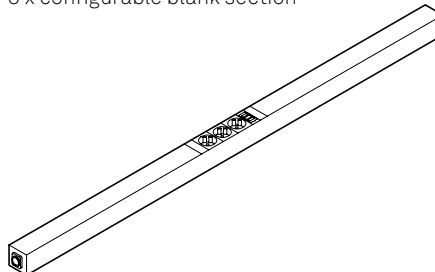


Zarge vorbereitet für Power Bar Mod. 704/10

Mod. 704/10 Power Bar with 4 modules

2741

Body optionally in black or white, with an input/output for Neutrik-powerCON® cable
 1 x power supply module (when ordering please state local standard)
 3 x configurable blank section



Ports for blank sections

Please note: Power and charging fields must be configured directly after one another

Power supply module (when ordering, state local standard)	221
Dual USB-A charging, 1/2 module	1344
Dual USB-C and USB-A charging, 1/2 module	2478
USB-C power charging 60W, module	3969
Blanking plate, 1/2 module	32
Blanking plate, module	42

Kabel

702/8 Neutrik-powerCON® supply lead



Length approx. 200 cm	483
Length approx. 300 cm	578
Length approx. 500 cm	882

702/9 Extension lead Neutrik-powerCON®



Length approx. 80 cm	746
Length approx. 100 cm	830
Length approx. 150 cm	987
Length approx. 200 cm	1124

Cable lid Executive set 150 x 300 mm

Table top group 1, laminate variant 1 and 2 14795

Table top group 2, veneer variant 1 and 2 17913

Basic cable lid set 120 x 300 mm

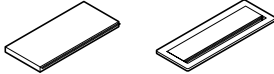
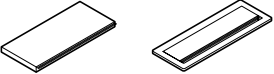
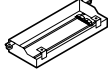







including fastening material for Power Bar socket strip, please order Power Bar separately 6174

Additional charge/reduced prices

Cable clip for the table legs (2) 137










Cable lid set with cable channel consisting of:	SEK	For mod. 614/00 M2 mounting position; cable lid set for positioning over the underframe consisting of:	SEK
Cable lid Executive or Basic		Cable lid Executive or Basic	
			
Cable channel to integrate the socket strip.		Strain relief 614/8	
			
Cable holder under the table top with hook and loop strap		Cable holder 614/9	
			
Cable clip for the table legs (2)		Cable clip for the table legs (2)	
			
Executive cable lid set 150 x 300 mm		Executive cable lid set 150 x 300 mm	
Table top group 1, laminate variant 1 and 2	14469	Table top group 1, laminate variant 1 and 2	10259
Table top group 2, veneer variant 1 and 2 incl. fastening material for socket strip, please order the socket strip separately, vertical fitting possible Can be combined with modesty panel on request	17378	Table top group 2, veneer variant 1 and 2 incl. fastening material for socket strip, please order socket strip separately, can be fitted horizontally	13283
Basic cable lid set 120 x 300 mm		Basic cable lid set 120 x 300 mm	
incl. fastening material for socket strip, please order the socket strip separately, vertical fitting possible Can be combined with modesty panel on request	6489	incl. fastening material for socket strip, please order socket strip separately, can be fitted horizontally	1901
Additional charge/reduced prices		Additional charge/reduced prices	
Cable harness covered with black textile sleeving	1407	Cable harness covered with black textile sleeving	1407
			



Socket strips for cable lid set

SEK

<p>Mod. 708/1 socket strip with 3 modules</p> <p>3 x power supply modules (when ordering state local standard) please order supply/connecting lead separately</p> 	630
<p>Mod. 708/2 socket strip with 3 modules:</p> <p>2 x power supply modules (when ordering please state the local standard) Please order supply-/connecting cable separately 1 x data module with 2 x RJ45 connectors (category 6, shielded) with patch cables permanently connected, approx. 350 cm long or optionally with 1 x slot with 2 x USB ports (charging current 2.1A) to recharge up to two mobile devices</p> 	2951
<p>Mod. 708/4 socket strip with 4 modules:</p> <p>4 x power supply modules (please state local standard when ordering) Please order supply/connecting lead separately</p> 	735
<p>Mod. 708/5 socket strip with 4 modules:</p> <p>2 x power supply modules (when ordering please state the local standard) please order supply/connecting cable separately 1 x data module with 2 x RJ45 jacks (category 6, shielded) with permanent patch cables approx. 350 cm long permanently attached 1 x VGA jack (15 pin D-sub) + 3.5 mm stereo jack or optionally HDMI jack with permanently attached cables, length approx. 300 cm</p> 	7518
<p>Mod. 708/6 socket strip with 5 modules:</p> <p>3 x power supply modules (state local standard when ordering) Please order power supply/connecting cable separately 1 x data module with 2 x RJ45 connectors (category 6 shielded) 1 x data module with 1 x RJ45 jack (category 6 shielded) with permanently attached patch cables approx. 350 cm long</p> 	4463

Additional charge/reduced prices

708/8 supply lead



Length approx. 200 cm
 Length approx. 300 cm
 Length approx. 500 cm

221
 263
 357

708/9 extension lead



Length approx. 200 cm
 Length approx. 300 cm

200
 252

Timetable
Mounting positions



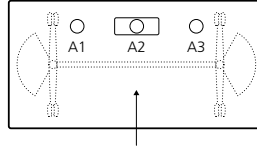
□ Integrated techni-station Basic, on both sides, cable lids, integrated techni-station Compact Duo or Power Bar

○ Integrated techni-station compact or cable outlet

A maximum of two built-in component sets are to be integrated per table. Possible positions: Either A/M 1 and A/M 3 or A/M 2.

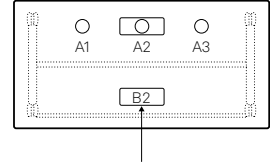
Timetable

610/00



Timetable Smart

612/00



Set	Mounting position	A 1	A 2	A 3	A 1	A 2	A 3	B 2
Integrated techni-station rotate	701/60 701/70	–	•	–	–	•	–	–
Cable lid Executive Basic		–	• ¹	–	–	–	–	–
Integrated techni-station compact	701/95	•	•	•	•	•	•	–
Integrated techni-station compact duo	701/96	–	•	–	–	•	–	–
Cable outlet set	707/1	•	•	•	•	•	•	–
Integrated techni-station Basic, on both sides, cable lids or Power Bar		–	• ¹	–	–	–	–	• ²

¹ from table depth 75 cm

² for table size 75 x 150 cm and 80 x 160 cm

• available

– not available

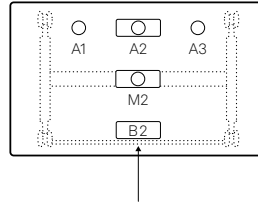


- Integrated techni-station basic, rotate or cable lids
- Integrated techni-station compact or cable outlet

A maximum of two built-in component sets are to be integrated per table. Possible positions: Either A/M 1 and A/M 3 or A/M 2.

Timetable Shift

614/00



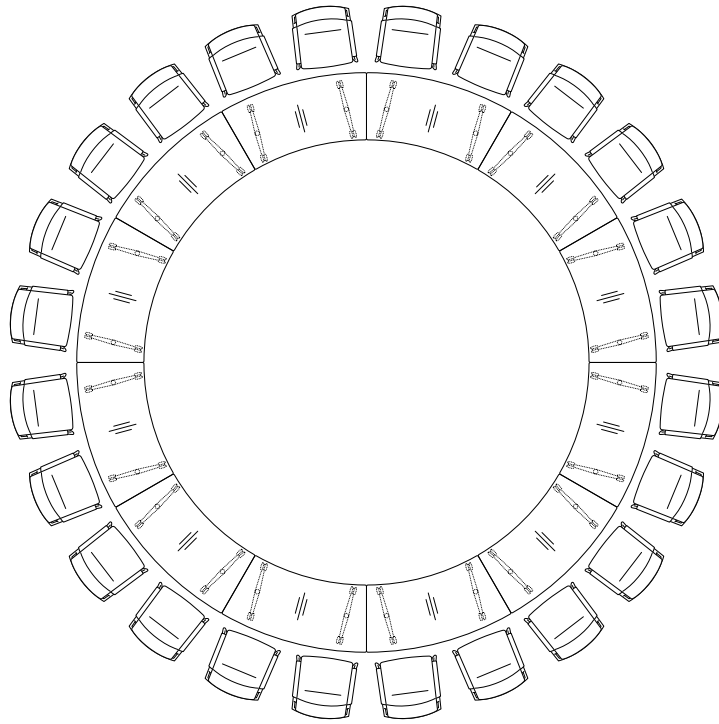
Set	Mounting position	A 1	A 2	A 3	B 2	M 2
Integrated techni-station rotate	701/60 701/70	–	•	–	–	–
Cable lid Executive Basic		–	• ¹	–	–	•
Integrierte Technikbox Compact	701/95	•	•	•	–	•
Integrated techni-station compact duo	701/96	–	•	–	–	•
Cable outlet set	707/1	•	•	•	–	•
Power Bar					•	•

¹ from table depth 100 cm

• available
– not available

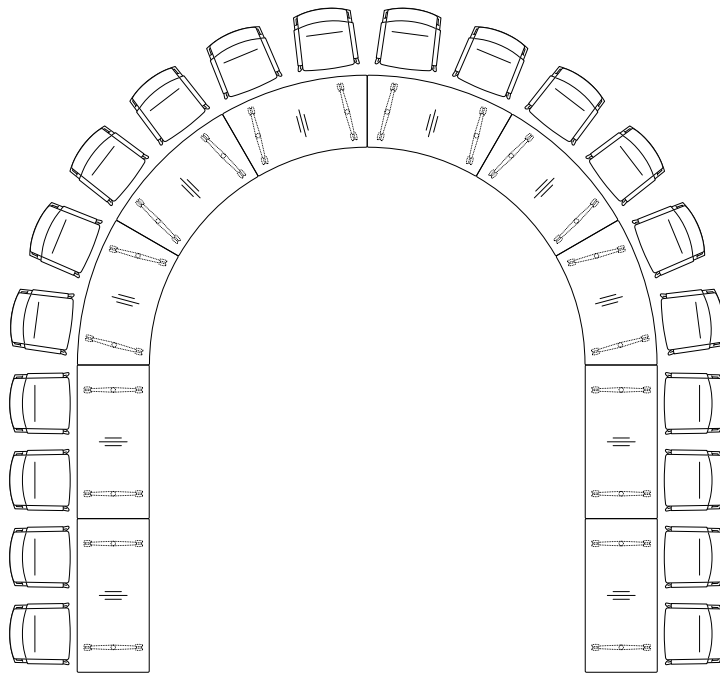


624



24 People,
Timetable
12 x Special element
120/161x80

632

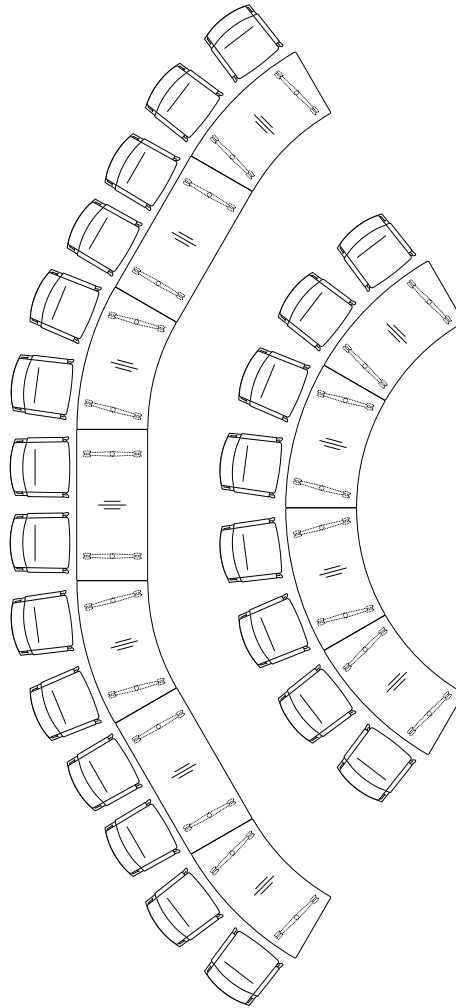


20 People,
Timetable
6 x Special element 120/161x80
4 x 610/00, 160x80

624

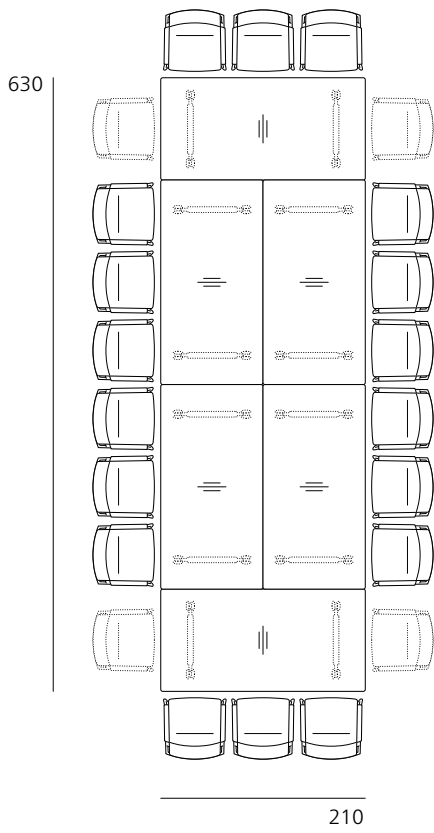


977

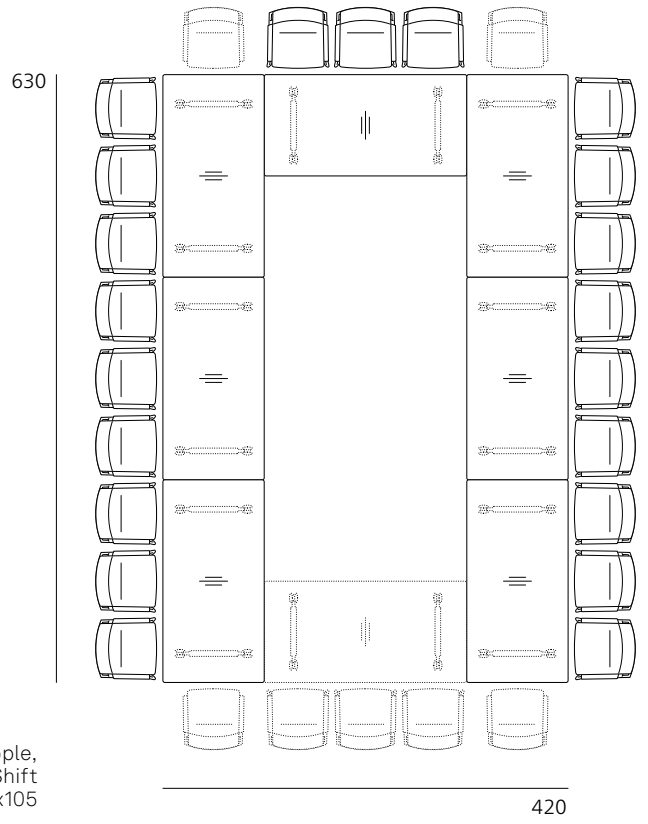


420

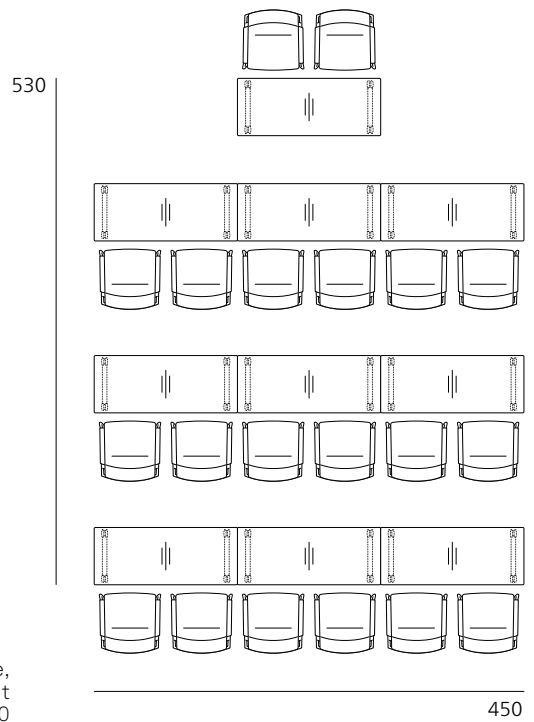
22 People,
Timetable
8 x Special element 120/161 x 80
3 x 610/00, 160x80



18 (22) People,
Timetable Shift
6 x 614/00, 210x105



21 (28) People,
Timetable Shift
7 (8) x 614/00, 210x105



20 People,
Timetable Smart
10 x 612/51, 150x60



615 Range Timetable Lift

Design: Andreas Störiko



Technical details

Function

A mobile table range with flip-top table tops. The Timetable range is ideal when combined with the Confair and Logon table ranges for multipurpose use of high-quality training, conference, presentation and meeting rooms. With a flip-top table top, Timetable tables nest compactly into one another, Timetable Lift comes with a locking mechanism and staggered storage when the tables nest into one another. Timetable Lift is electrically height-adjustable (73-139 cm), optionally battery operated. With a surface that can be written and that's optionally magnetic for use as a whiteboard and projection screen.

Frame

Aluminum foot section, bright chrome-plated, polished or with a silver satin finish or black coating. Electric telescopic column with an integrated sensor to stop things getting stuck in it. Uprights and crossways underframe in tubular steel, coated in black or with a silver satin finish. Table top bearer in steel profile, draw rod in round steel tubing, coated black. Lockable, height-adjustable, swivel casters with a black polyamide tire are the standard version for carpets; casters available with a polyurethane tire for hard floors (please specify when ordering). The electrical control, including a three-meter supply lead and cable mesh, as well as the fitting for the optional battery are mounted underneath the table top.

Core material of table top

Plywood with bullnose (double) or straight wood edging all the way round with integrated impact-resilient profile made of black elastomer or with straight, plastic edging all the way round. Timetable Lift has an integrated button to adjust the height.

Table top group 1 – laminate

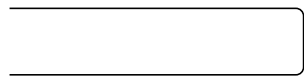
Table top thickness 26 mm

Variant 1

Laminate (single color) based on Wilkhahn's color and surface samples with wood edging, natural oiled finish.



Standard type: bullnose with impact-resilient profile



Alternatively: straight edge with impact-resilient profile

Wood decor laminate from the Wilkhahn color and surface samples with color-matched plastic edging.



Straight plastic edging

Variant 2

Soft matte laminate from the Wilkhahn color and surface samples with wood edging in a natural oiled finish or color-matched with the plastic edging. Anti-reflective, soft-touch surface with anti-fingerprint characteristics.



Standard type: bullnose with impact-resilient profile



Alternatively: straight edge with impact-resilient profile



Straight plastic edging

Table top group 2 – veneer

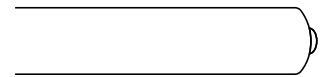
Table top thickness 26 mm

Variant 1

Beech, oak and ash veneer from Wilkhahn woodstain color samples with wood edging, as far as possible in the same colour as the veneer

Variant 2

Maple, walnut or elm veneer from the Wilkhahn woodstain color samples with wood edging, color-matched as far as possible with the veneer.



Standard type: bullnose with impact-resilient profile



Alternatively: straight edge with impact-resilient profile



Veneer type

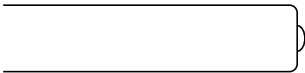
As a standard, the veneers are made by slip-match method. Surfaces sealed with clear lacquer: open-pore: Oak, ash, walnut and elm veneer closed-pore: maple and beech veneer. Some specific growth features possible.

Table top with whiteboard

Table top thickness 26 mm white laminate with color-matched plastic edging. Table top can be written on with board marker pens, dry wiped and used as a projection screen, optionally magnetic.



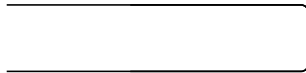
Straight plastic edging



Straight edging with an impact-resilient profile

Table top with whiteboard

Table top thickness 26 mm, very shiny white laminate with color-matched plastic edging. Table top can be written on with board marker pens, dry wiped and is magnetic. The very shiny surface causes more light reflection, so it's not suitable as a projection screen.



Straight plastic edging



Straight edging with an impact-resilient profile

Battery box

Compact and powerful lithium ion battery with 2.2 AH capacity, allowing the table to be raised about 40 times after being fully charged. With an LED charge indicator and acoustic signal to indicate that recharging is required. With retrofittable charger.

Standards

The Timetable Lift tables comply with the DIN EN 527 standard.



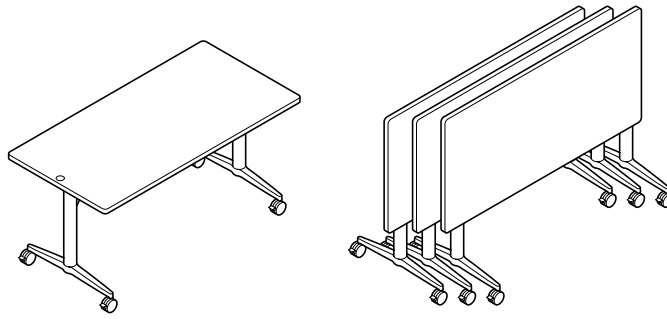
www.tuv.com
ID 100000000



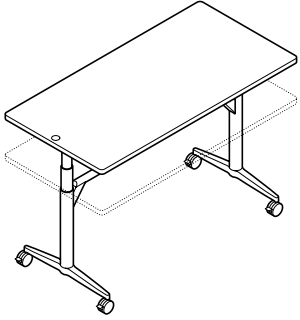
When placing repeat orders, please indicate whether your table tops have slip-matched or book-matched veneer.

Tables	Foot section	Upright and underframes	Supports
48	Coated white (RAL 9016)	Coated white	Coated black
51	Bright chrome-plated	Silver satin finish, coated black or black with textured matte finish	Coated black
52	Polished aluminum	Silver satin finish, coated black or black with textured matte finish	Coated black
53	Coated black (RAL 9011)	Coated black	Coated black
60	Coated with a silver satin finish (RAL 9006)	Coated with a silver satin finish	Coated with a silver satin finish

**Timetable Lift
Tables**



Rectangular



615/00

Electrically adjustable height (73 - 139 cm)
Coated aluminum foot section, coated uprights and underframes

Polished aluminum foot section, coated uprights and underframes

Additional charge/reduced prices

Polished aluminum foot section, coated uprights and underframes

Bright chrome-plated aluminum foot section, uprights and underframes coated

Plastic lipping all the way round for laminate variant 1 (single color) and 2 **per running meter**

Battery box: Lithium ion battery with charger

SEK

1176

2415

-220

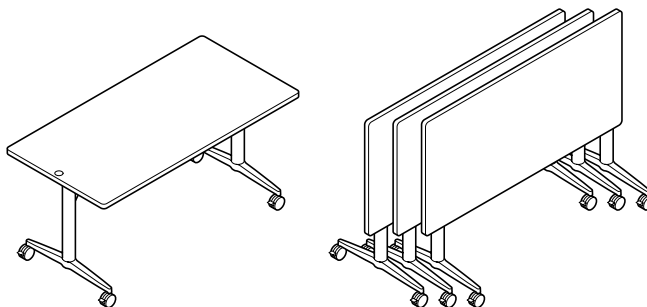
3455

Table top group

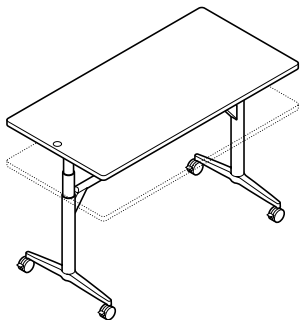
	Width	Depth			
		75	80	90	100
1 Laminate variant 1	150	29747	-	-	-
	160	-	30503	-	-
	180	-	-	33317	-
	200	-	-	-	40457
1 Laminate variant 2	150	32183	-	-	-
	160	-	33296	-	-
	180	-	-	36824	-
	200	-	-	-	43932
2 Veneer variant 1	150	33033	-	-	-
	160	-	34157	-	-
	180	-	-	37674	-
	200	-	-	-	46137
2 Veneer variant 2	150	37527	-	-	-
	160	-	38136	-	-
	180	-	-	42347	-
	200	-	-	-	51849

- not available

**Timetable Lift
Tables**



Rectangular



615/10 **SEK**
 with board functionality
 electrically adjustable height (73 - 139 cm)
 White board, can be written on with board marker pens,
 can be used as a projection screen
 Coated aluminum foot section, coated uprights and underframes

Additional charge/reduced prices

Polished aluminum foot section, coated uprights and underframes	1176
Bright chrome-plated aluminum foot section, uprights and underframes coated	2415
Plastic edging all the way round with impact-resilient profile per running meter	284
Battery box: Lithium ion battery with charger	3455

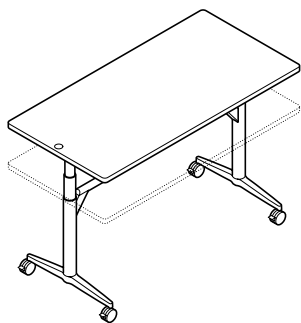
Table top group

	Width	Depth			
		75	80	90	100
1 Table top with whiteboard	150	27048	-	-	-
	160	-	27731	-	-
	180	-	-	30744	-
	200	-	-	-	38357
1 Table top with magnetic whiteboard	150	31584	-	-	-
	160	-	32949	-	-
	180	-	-	35364	-
	200	-	-	-	42042

- not available



Rectangular



615/11

mit Whiteboard-Funktion
Elektromotorisch höhenverstellbar (73 - 139 cm)
Platte hochglanz weiß, beschriftbar mit Tafelschreibern,
mit Whiteboard-Funktion
Elektromotorisch höhenverstellbar (73 - 139 cm)
Platte hochglanz weiß, beschriftbar mit Tafelschreibern,

SEK

Additional charge/reduced prices

Polished aluminum foot section, coated uprights and underframes	1176
Bright chrome-plated aluminum foot section, uprights and underframes coated	2415
Plastic edging all the way round with impact-resilient profile per running meter	284
Battery box: Lithium-ion battery with charger	3455

Table top group

	Width	Depth			
		75	80	90	100
5	150	34146	-	-	-
	160	-	35511	-	-
	180	-	-	39207	-
	200	-	-	-	45885

- not available



SEK

Battery box

615/01

Compact and powerful lithium-ion battery
with charger, retrofittable

3455

Whiteboard set pro



615/02

For Timetable Lift with whiteboard functionality, consisting of:
1 organizer bag made of gray felt to hang on the underframe or table top,
4 whiteboard pens in black, red, green, blue with a chisel tip
1 extra large cloth 40 x 40 cm
2 whiteboard erasers for occasional cleaning
10 magnets, Ø 34 mm, white
1 bottle of board cleaner, 250 ml pump-action spray

2688

620 Range Logon

Design: Andreas Störiko



Technical details

Function

Stand-alone tables for offices and systems components for permanently linked table configurations in conference rooms, ideal in combination with Confair folding tables in conference spaces that can be partitioned in different ways.

Frame

Die-cast aluminum foot section, bright chrome-plated, polished or with a coating from the Wilkhahn color samples. Aluminum profile upright, clear anodized or silver satin finish, or black coating; with bright chrome-plated foot sections, coated in black. The foot sections are at an angle when the table depth is 75 cm.

Die-cast aluminum bearers, depending on the foot section with a silver satin finish or coated black. Upright optionally available bright chrome-plated. Aluminum profile underframe, depending on the foot section with a silver satin finish or coated black. Table depths 75 - 90 cm with a center underframe, table depths 100 - 130 cm with two underframes. Polyamide glides in black. Lockable, black polyamide casters. Model 621/35: Steel profile underframes, depending on the base with a silver satin finish or coated black. Polyamide glides in black.

Core material of table top

Plywood with bullnose or straight wood lipping all the way round with integrated, impact-resilient profile in black elastomer or straight plastic lipping all the way round. For system elements: straight joining edge, without profile.

Table top group 1 – laminate

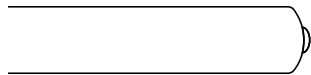
Table top thickness 26 mm

Variant 1

Laminate (single color) from the Wilkhahn color and surface samples with wood lipping, natural oiled finish or color-matched plastic lipping. Wood decor laminate on request.

Variant 2

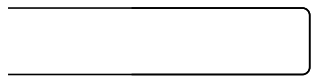
Soft matte laminate from the Wilkhahn color and surface samples with wood edging, natural oiled finish or color-matched plastic edging. Anti-fingerprint, anti-reflective and soft-touch characteristics.



Standard type: Bullnose with integrated impact-resilient profile



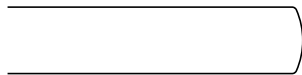
Alternatively: straight with integrated impact-resilient profile



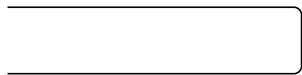
Straight plastic lipping

Table top group 2 – veneer

Table top thickness 26 mm



Standard type: Bullnose with impact-resilient profile



Alternatively: Straight edging with an impact-resilient profile

Variant 1

Beech, oak or ash veneer (exception: natural ash with chamfered edging not possible) from the Wilkhahn woodstain color samples with wood edging, color-matched as far as possible with the veneer.

Variant 2

Maple (exception: no maple with a natural finish with chamfered edging), walnut or elm veneer from the Wilkhahn woodstain color samples with wood edging, color-matched as far as possible with the veneer.

Veneer type

As a standard, the veneers are made by slip-match method. Surfaces sealed with clear lacquer: open-pore: Oak, ash, walnut and elm veneer closed-pore: Maple and beech veneer. Some specific growth features possible.

When placing repeat orders, please indicate whether your table tops have slip-matched or book-matched veneer.

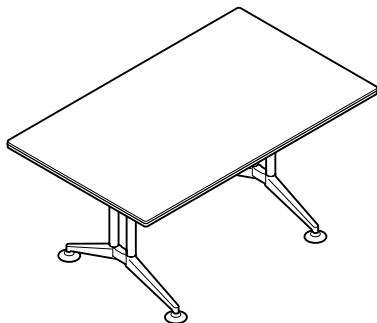
Modesty panels

Ribbed aluminum extruded profile clear anodized or coated black. Clear anodized screws connected to the table top. Modesty panels can also be retrofitted. Price on request.

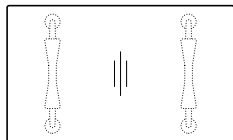
Standards

The Logon tables comply with the ANSI/BIFMA X 5.5 standard.

Tables	Foot section	Upright	Bearers and underframes
51	Bright chrome-plated	Coated black or bright chrome-plated	Coated black
52	Polished aluminum	Clear anodized aluminum	Coated with a silver satin finish
53	Coated black (RAL 9011)	Coated black	Coated black
60	Coated with a silver satin finish (RAL 9006)	Coated with a silver satin finish	Coated with a silver satin finish
90	Coated with a black textured matte finish (RAL 9011)	Coated with a black textured matte finish (RAL 9011)	Coated with a black textured matte finish (RAL 9011)



Rectangular



620/00

120 x 240, H 73
Coated aluminum foot section and upright

SEK

Additional charge/reduced prices

Polished aluminum foot section, clear anodized aluminum upright 1176
Bright chrome-plated aluminum foot section, aluminum upright coated black 2415
Bright chrome-plated aluminum foot section and upright 5334

Plastic lipping all the way round for laminate variant 1 (single color) and 2 **per running meter** -220

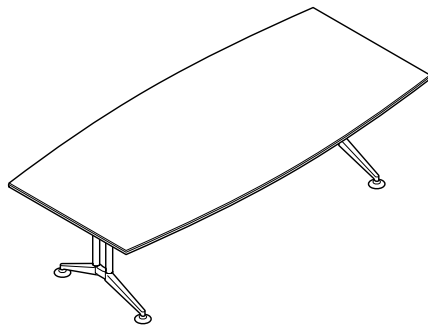
Coated aluminum modesty panel (length 150 cm) 5660
Clear anodized aluminum modesty panel (length 150 cm) 5975
Coated aluminum modesty panel (length 180 cm) 6552
Clear anodized aluminum modesty panel (length 180 cm) 6920
Coated aluminum modesty panel (length 240 cm) 8862
Clear anodized aluminum modesty panel (length 240 cm) 9419

with casters (available up to a max. width of 200 cm) 2142

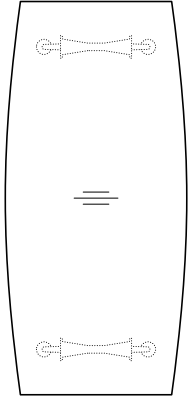
Table top group

	Width	Depth						
		75	80	90	100	110	120	130
1 Laminate variant 1	150	17724	21032	22124	22554	23153	24045	24203
	160	19299	21672	22544	22785	23478	24245	24339
	180	19940	22323	23006	24161	24350	24717	24980
	200	21074	23310	24119	25505	25704	26082	26355
	220	21662	24171	25326	26681	26891	27279	28224
	230	21945	25074	26135	26859	27185	27542	29106
	240	22197	25326	26544	27227	27594	27762	29453
	300	-	-	-	31689	32288	32508	34797
1 Laminate variant 2	150	20087	23489	24906	25704	26586	27783	28298
	160	21777	24329	25536	26135	27143	28256	28697
	180	22764	25326	26366	27899	28508	29222	29852
	200	24192	26649	27878	29684	30293	31080	31773
	220	25085	27836	29442	31280	31931	32781	34167
	230	25568	28917	30450	31668	32456	33296	35333
	240	25946	29327	31049	32246	33096	33747	35973
	300	-	-	-	37937	39165	40016	42914
2 Veneer variant 1	150	18365	21777	23163	23436	24203	25085	25295
	160	20087	22470	23384	23741	24686	25368	25599
	180	20759	23121	23867	25263	25589	26009	26261
	200	22008	24287	25179	26807	27059	27437	27857
	220	22617	25211	26492	27647	28340	28697	29736
	230	23069	26261	27437	28350	28529	28991	30713
	240	23237	26492	27878	28560	29169	29453	31301
	300	-	-	-	33453	34167	34482	36971
2 Veneer variant 2	150	21830	25505	27185	28203	29358	30440	31448
	160	23751	26376	28046	28445	30030	31490	31878
	180	24791	27783	28571	30734	31574	32046	32508
	200	26397	29600	30566	33065	33422	34461	34986
	220	27773	31427	32592	34661	35396	36435	37958
	230	28371	32351	33905	35375	36288	36887	39134
	240	28917	32592	35102	36446	36950	37485	39827
	300	-	-	-	41969	42830	43439	46809

- not available



Barrel shape



627/42

e. g. 100/120 x 260, H 73
Coated aluminum foot section and upright

SEK

Additional charge/reduced prices

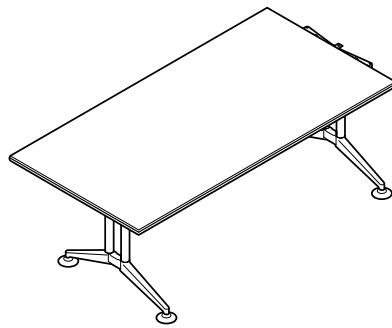
Polished aluminum foot section, clear anodized aluminum upright 1176
Bright chrome-plated aluminum foot section, aluminum upright coated black 2415
Bright chrome-plated aluminum foot section and upright 5334

Plastic lipping all the way round for laminate variant 1 (single color) and 2 **per running meter** -220

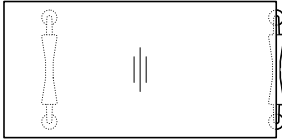
Table top group

	Width	Depth	
		100/120	100/130
1 Laminate variant 1	240	30303	-
	260	35732	-
	300	-	36299
1 Laminate variant 2	240	36299	-
	260	42242	-
	300	-	44436
2 Veneer variant 1	240	31868	-
	260	37947	-
	300	-	38252
2 Veneer variant 2	240	39050	-
	260	46652	-
	300	-	47019

- not available



Rectangular



620/11

Starting element
e.g. 90 x 180, H 73
Can be extended with the 620/21, 620/31, 624/91 models
Coated aluminum foot section and upright

SEK

Additional charge/reduced prices

Polished aluminum foot section, clear anodized aluminum upright
Bright chrome-plated aluminum foot section, aluminum upright coated black
Bright chrome-plated aluminum foot section and upright

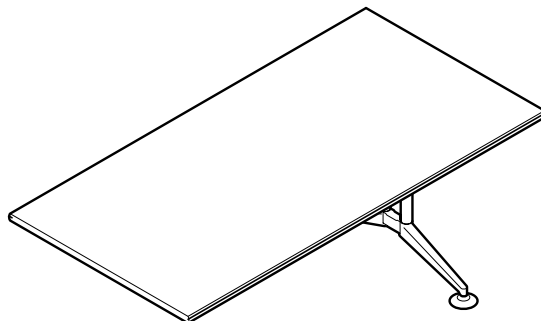
1176
2415
5334

Plastic lipping all the way round for laminate variant 1 (single color) and **2 per running meter**

-220

Table top group

	Width	Depth					
		80	90	100	110	120	130
1 Laminate variant 1	160	21672	22544	22785	23478	24245	24339
	180	22323	23006	24161	24350	24717	24980
	200	23310	24119	25505	25704	26082	26355
	220	24171	25326	26681	26891	27279	28224
	240	25326	26544	27227	27594	27762	29453
1 Laminate variant 2	160	24329	25536	26135	27143	28256	28697
	180	25326	26366	27899	28508	29222	29852
	200	26649	27878	29684	30293	31080	31773
	220	27836	29442	31280	31931	32781	34167
	240	29327	31049	32246	33096	33747	35973
2 Veneer variant 1	160	22470	23384	23741	24686	25368	25599
	180	23121	23867	25263	25589	26009	26261
	200	24287	25179	26807	27059	27437	27857
	220	25211	26492	27647	28340	28697	29736
	240	26492	27878	28560	29169	29453	31301
2 Veneer variant 2	160	26376	28046	28445	30030	31490	31878
	180	27783	28571	30734	31574	32046	32508
	200	29600	30566	33065	33422	34461	34986
	220	31427	32592	34661	35396	36435	37958
	240	32592	35102	36446	36950	37485	39827



Rectangular



620/21

Finishing element
e. g. 90 x 180, H 73
Coated aluminum foot section and upright

SEK

Additional charge/reduced prices

Polished aluminum foot section, clear anodized aluminum upright
Bright chrome-plated aluminum foot section, aluminum upright coated black
Bright chrome-plated aluminum foot section and upright

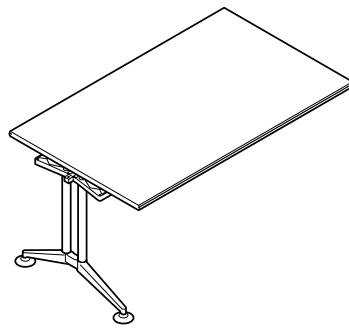
588
1208
2667

Plastic lipping all the way round for laminate variant 1 (single color) and 2 **per running meter**

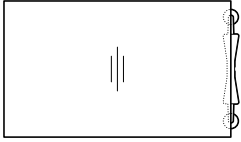
-220

Table top group

	Width	Depth					
		80	90	100	110	120	130
1 Laminate variant 1	160	16296	17168	17409	18102	18869	18963
	180	16947	17630	18785	18974	19341	19604
	200	17934	18743	20129	20328	20706	20979
	220	18795	19950	21305	21515	21903	22848
	240	19950	21168	21851	22218	22386	24077
1 Laminate variant 2	160	18953	20160	20759	21767	22880	23321
	180	19950	20990	22523	23132	23846	24476
	200	21273	22502	24308	24917	25704	26397
	220	22460	24066	25904	26555	27405	28791
	240	23951	25673	26870	27720	28371	30597
2 Veneer variant 1	160	17094	18008	18365	19310	19992	20223
	180	17745	18491	19887	20213	20633	20885
	200	18911	19803	21431	21683	22061	22481
	220	19835	21116	22271	22964	23321	24360
	240	21116	22502	23184	23793	24077	25925
2 Veneer variant 2	160	21000	22670	23069	24654	26114	26502
	180	22407	23195	25358	26198	26670	27132
	200	24224	25190	27689	28046	29085	29610
	220	26051	27216	29285	30020	31059	32582
	240	27216	29726	31070	31574	32109	34451



Rectangular



620/31

Intermediate element
e. g. 90 x 180, H 73
Coated aluminum foot section and upright

SEK

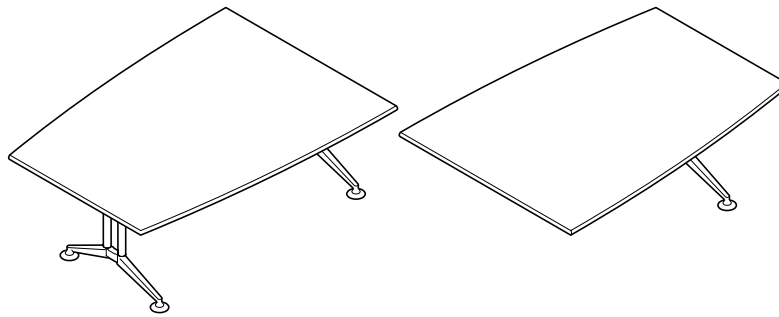
Additional charge/reduced prices

Polished aluminum foot section, clear anodized aluminum upright 588
Bright chrome-plated aluminum foot section, aluminum upright coated black 1208
Bright chrome-plated aluminum foot section and upright 2667

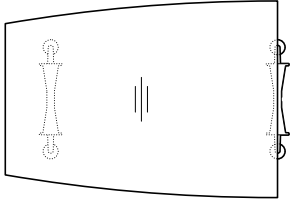
Plastic lipping all the way round for laminate variant 1 (single color) and 2 **per running meter** -220

Table top group

	Width	Depth					
		80	90	100	110	120	130
1 Laminate variant 1	160	16296	17168	17409	18102	18869	18963
	180	16947	17630	18785	18974	19341	19604
	200	17934	18743	20129	20328	20706	20979
	220	18795	19950	21305	21515	21903	22848
1 Laminate variant 2	160	18953	20160	20759	21767	22880	23321
	180	19950	20990	22523	23132	23846	24476
	200	21273	22502	24308	24917	25704	26397
	220	22460	24066	25904	26555	27405	28791
2 Veneer variant 1	160	17094	18008	18365	19310	19992	20223
	180	17745	18491	19887	20213	20633	20885
	200	18911	19803	21431	21683	22061	22481
	220	19835	21116	22271	22964	23321	24360
2 Veneer variant 2	160	21000	22670	23069	24654	26114	26502
	180	22407	23195	25358	26198	26670	27132
	200	24224	25190	27689	28046	29085	29610
	220	26051	27216	29285	30020	31059	32582



Semi-barrel shape



627/51

Starting element
e. g. 100/130 x 180, H 73
Can be extended with models 627/61 and 620/31
Coated aluminum foot section and upright

SEK

Additional charge/reduced prices

Polished aluminum foot section, clear anodized aluminum upright
Bright chrome-plated aluminum foot section, aluminum upright coated black
Bright chrome-plated aluminum foot section and upright

1176
2415
5334

Plastic lipping all the way round for laminate variant 1 single color) and 2 **per running meter**

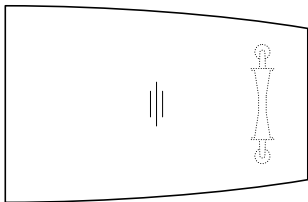
-220

Table top group

Width
Depth
100/130

1 Laminate variant 1	160	32277
	180	32907
	200	34304
1 Laminate variant 2	160	36624
	180	37769
	200	39701
2 Veneer variant 1	160	33642
	180	34325
	200	35921
2 Veneer variant 2	160	40362
	180	40961
	200	43460

Semi-barrel shape



627/61

Finishing element
e. g. 100/130 x 180, H 73
Coated aluminum foot section and upright

SEK

Additional charge/reduced prices

Polished aluminum foot section, clear anodized aluminum upright
Bright chrome-plated aluminum foot section, aluminum upright coated black
Bright chrome-plated aluminum foot section and upright

588
1208
2667

Plastic lipping all the way round for laminate variant 1 single color) and 2 **per running meter**

-220

Table top group

Width
Depth
100/130

1 Laminate variant 1	160	26901
	180	27531
	200	28928
1 Laminate variant 2	160	31248
	180	32393
	200	34325
2 Veneer variant 1	160	28266
	180	28949
	200	30545
2 Veneer variant 2	160	34986
	180	35585
	200	38084



SEK

Cable outlet




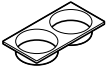








707/1
Black plastic, Ø 80 mm

462


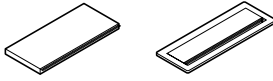

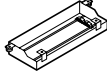









Integrated techni-station Basic set consisting of:	SEK	Integrated techni-station Rotate set consisting of:	SEK
<p>Integrated techni-station basic 701/00 or 701/10</p>  <p>Cable cover for techni-station</p>  <p>Cable holder under the table top with hook and loop strap</p>  <p>Cable clip for the table legs (2)</p> 		<p>Integrated techni-station rotate 701/60 or 701/70</p>  <p>Cable cover for techni-station</p>  <p>Cable holder under the table top with hook and loop strap</p>  <p>Cable clip for the table legs (2)</p> 	
<p>Integrated techni-station Basic set 701/00 with 3 modules:</p> <p>2 x power supply modules (please state local standard when ordering) with supply lead, approx. 300 cm in length 1 x data module with 2 x RJ 45 jacks (category 6, shielded) with permanently attached patch cables, 350 cm in length or optionally with USB charger type A + type C with Smart IC and PD 2.0 to recharge up to two mobile devices.</p>	7623	<p>Integrated techni-station Rotate set 701/60 with 3 modules:</p> <p>2 x power supply modules (please state local standard when ordering) with supply lead, approx. 300 cm in length 1 x data module with 2 x RJ45 jacks (category 6, shielded) with permanently attached cables, approx. 350 cm in length or optionally with USB charger type A + type C with Smart IC and PD 2.0 to recharge up to two mobile devices.</p>	7844
<p>Integrated techni-station Basic set 701/10 with 4 modules:</p> <p>2 x power supply modules (when ordering please state the local standard) with supply lead approx. 300 cm long 1 x data module with 2 x RJ45 connectors (category 6, shielded) with patch cables approx. 350 cm long permanently attached 1 x slot with VGA connector + 3.5 mm stereo jack or optionally HDMI connector with permanently attached cables, length approx. 300 cm</p>	12191	<p>Set Integrated Techni-Station Rotate 701/70 with 4 modules:</p> <p>2 x power supply modules (when ordering please state the local standard) with supply lead approx. 300 cm long 1 x data module with 2 x RJ45 connectors (category 6, shielded) with cables approx. 350 cm long permanently attached 1 x slot with VGA connector (15 pin D-sub) + 3.5 mm stereo jack or optionally HDMI connector with permanently attached cables, length approx. 300 cm</p>	12369
<p>Additional charge/reduced prices</p> <p>Techni-station with mechanism that opens by pressing the top 1008</p> <p>Cable harness covered with black textile sleeving 1376</p>  <p>620/2 Vertical cable channel for cable management between the uprights Coated black or in a silver satin finish 4568</p> 		<p>Additional charge/reduced prices</p> <p>Techni-station with mechanism that opens by pressing the top 1008</p> <p>Cable harness covered with black textile sleeving 1376</p>  <p>620/2 Vertical cable channel for cable management between the uprights Coated black or in a silver satin finish 4568</p> 	



Integrated techni-station Compact set consisting of:	SEK	Integrated techni-station Compact Duo set consisting of:	SEK
Round or square installation frame compact 		Rectangular installation frame compact duo 	
Multimedia 		Multimedia 	
Cable holder under the table top with hook and loop strap 		Cable holder under the table top with hook and loop strap 	
Cable clip for the table legs (2) 		Cable clip for the table legs (2) 	
Set integrated techni-station Compact 701/95 with slot for cable outlet chrome matte and surface with brushed strip/brushed profile	1827	Set Integrated techni-station Compact Duo 701/96 with slot for cable outlet chrome matte, with surface with brushed strip/brushed profile*	1239
Integrated techni-station Compact set 701/95 with wireless charging slot:	4085	Integrated techni-station Compact Duo set 701/96 with wireless charging slot*:	3465
1 x slot with wireless charging module (5 watt, Qi compliant) with supply lead approx. 180 cm and power supply unit		1 x slot with wireless charging module (5 watt, Qi compliant) with supply lead approx. 180 cm and power supply unit	
Integrated techni-station Compact set 701/95 with power supply module:	2426	Integrated techni-station Compact Duo set 701/96 with power supply module*:	1817
1 x power supply module (when ordering please state the local standard) with 40 cm supply lead, mod. 708/8 2 x slots with cover for optional Keystone modules		1 x power supply module (when ordering please state the local standard) with 40 cm supply lead, mod. 708/8 2 x slots with cover for optional Keystone modules	
Integrated techni-station Compact set 701/95 with power supply module and USB port*:	3896	Integrated techni-station Compact Duo set 701/96 with power supply module and USB port*:	3266
1 x power supply module (when ordering please state the local standard) with 40 cm supply lead, mod. 708/8 1 x USB port with Smart IC (charging current 2A max.) 1 x slot with cover for optional Keystone modules		1 x power supply module (when ordering please state the local standard) with 40 cm supply lead, mod. 708/8 1 x USB port with Smart IC (charging current 2A max.) 1 x slot with cover for optional Keystone modules	
Additional charge/reduced prices		Additional charge/reduced prices	
Keystone module RJ 45 connector (category 6) as a thru-type coupling, without cables	147	Keystone module RJ 45 jack (category 6) as a thru-type coupling, without cables	147
Keystone module, HDMI jack as a thru-type coupling, without cables	284	Keystone module, HDMI jack as a thru-type coupling, without cables	284
708/8 supply lead		708/8 supply lead	
 Length approx. 200 cm	221	 Length approx. 200 cm	221
Length approx. 300 cm	263	Length approx. 300 cm	263
Length approx. 500 cm	357	Length approx. 500 cm	357
Cable harness covered with black textile sleeving	1376	Cable harness covered with black textile sleeving	1376
620/2 Vertical cable channel for cable management between the uprights Coated black or in a silver satin finish	4568	620/2 Vertical cable channel for cable management between the uprights Coated black or in a silver satin finish	4568



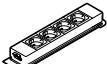




Cable outlet set consisting of:	SEK	Cable lid set consisting of:	SEK
Cable outlet 707/1 		Cable lid Executive or Basic 	
Cable holder under the table top with hook and loop strap 		Cable channel to integrate the socket strip. 	
Cable clip for the table legs (2) 		Cable holder under the table top with hook and loop strap 	
		Cable clip for the table legs (2) 	
Cable outlet set 707/1 Black plastic, Ø 80 mm	1722	Executive cable lid set 150 x 300 mm Table top group 1, laminate variant 1 and 2	15624
		Table top group 2, veneer variant 1 and 2 incl. fastening material for socket strip, please order socket strip separately, can be fitted at 15° or vertically (please state angle when ordering)	18753
		Basic cable lid set 120 x 300 mm incl. fastening material for socket strip, please order socket strip separately, can be fitted at 15° or vertically (please state angle when ordering)	7014
Additional charge/reduced prices Cable harness covered with black textile sleeving 	1376	Additional charge/reduced prices Cable harness covered with black textile sleeving 	1407
620/2 Vertical cable channel for cable management between the uprights Coated black or in a silver satin finish 	4568	620/2 Vertical cable channel for cable management between the uprights Coated black or in a silver satin finish 	4568



Socket strips for cable lid set

SEK

<p>Mod. 708/1 socket strip with 3 modules</p> <p>3 x power supply modules (when ordering state local standard) please order supply/connecting lead separately</p> 	630
<p>Mod. 708/2 socket strip with 3 modules:</p> <p>2 x power supply modules (when ordering please state the local standard) Please order supply-/connecting cable separately 1 x data module with 2 x RJ45 connectors (category 6, shielded) with patch cables permanently connected, approx. 350 cm long or optionally with 1 x slot with 2 x USB ports (charging current 2.1A) to recharge up to two mobile devices</p> 	2951
<p>Mod. 708/4 socket strip with 4 modules:</p> <p>4 x power supply modules (please state local standard when ordering) Please order supply/connecting lead separately</p> 	735
<p>Mod. 708/5 socket strip with 4 modules:</p> <p>2 x power supply modules (when ordering please state the local standard) please order supply/connecting cable separately 1 x data module with 2 x RJ45 jacks (category 6, shielded) with permanent patch cables approx. 350 cm long permanently attached 1 x VGA jack (15 pin D-sub) + 3.5 mm stereo jack or optionally HDMI jack with permanently attached cables, length approx. 300 cm</p> 	7518
<p>Mod. 708/6 socket strip with 5 modules:</p> <p>3 x power supply modules (state local standard when ordering) Please order power supply/connecting cable separately 1 x data module with 2 x RJ45 connectors (category 6 shielded) 1 x data module with 1 x RJ45 jack (category 6 shielded) with permanently attached patch cables approx. 350 cm long</p> 	4463

Additional charge/reduced prices

<p>708/8 supply lead</p> 	<p>Length approx. 200 cm 221 Length approx. 300 cm 263 Length approx. 500 cm 357</p>
<p>708/9 extension lead</p> 	<p>Length approx. 200 cm 200 Length approx. 300 cm 252</p>



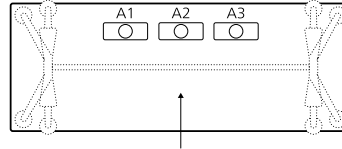
□ Integrated techni-station basic, rotate, cable lids or integrated techni-station compact duo

○ Integrated techni-station compact or cable outlet

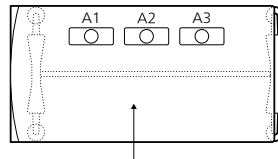
A maximum of two built-in component sets are to be integrated per table. Possible positions: Either A/M 1 and A/M 3 or A/M 2.

Table depth ≤ 90 cm

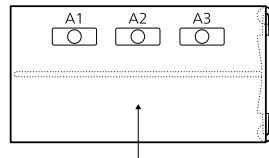
620/00



620/11



620/31



620/21

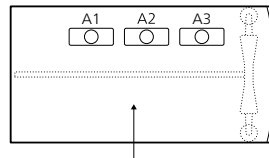
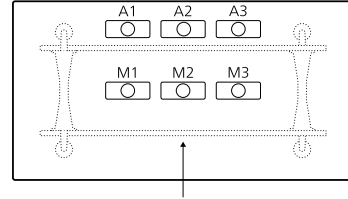
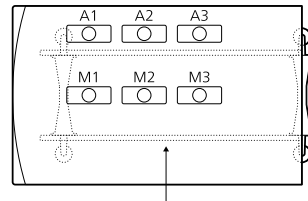


Table depth > 90 cm

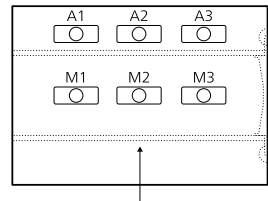
620/00



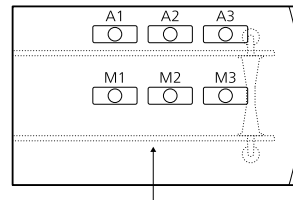
620/11



620/31



620/21



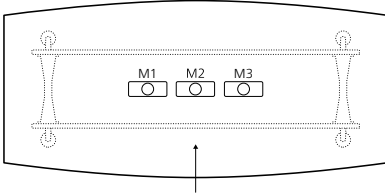
Set	Mounting position	A1 ¹	A2	A3 ¹	A1 ¹	A2	A3 ¹	M1 ¹	M2	M3 ¹
Integrated techni-station basic	701/00 701/10	•	•	•	• ²	• ²	• ²	•	•	•
Integrated techni-station rotate	701/60 701/70	•	•	•	• ²	• ²	• ²	•	•	•
Cable lid Executive Basic		•	•	•	•	•	•	•	•	•
Integrated techni-station compact	701/95	•	•	•	•	•	•	•	•	•
Integrated techni-station compact duo	701/96	•	•	•	• ²	• ²	• ²	•	•	•
Cable outlet set	707/1	•	•	•	•	•	•	•	•	•

¹ from table width 200 cm
² from table depth 120 cm
³ from 200 cm diameter

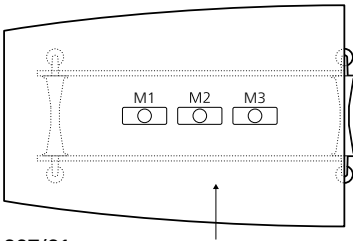
• available
– not available



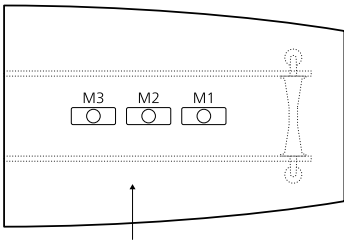
627/42



627/51

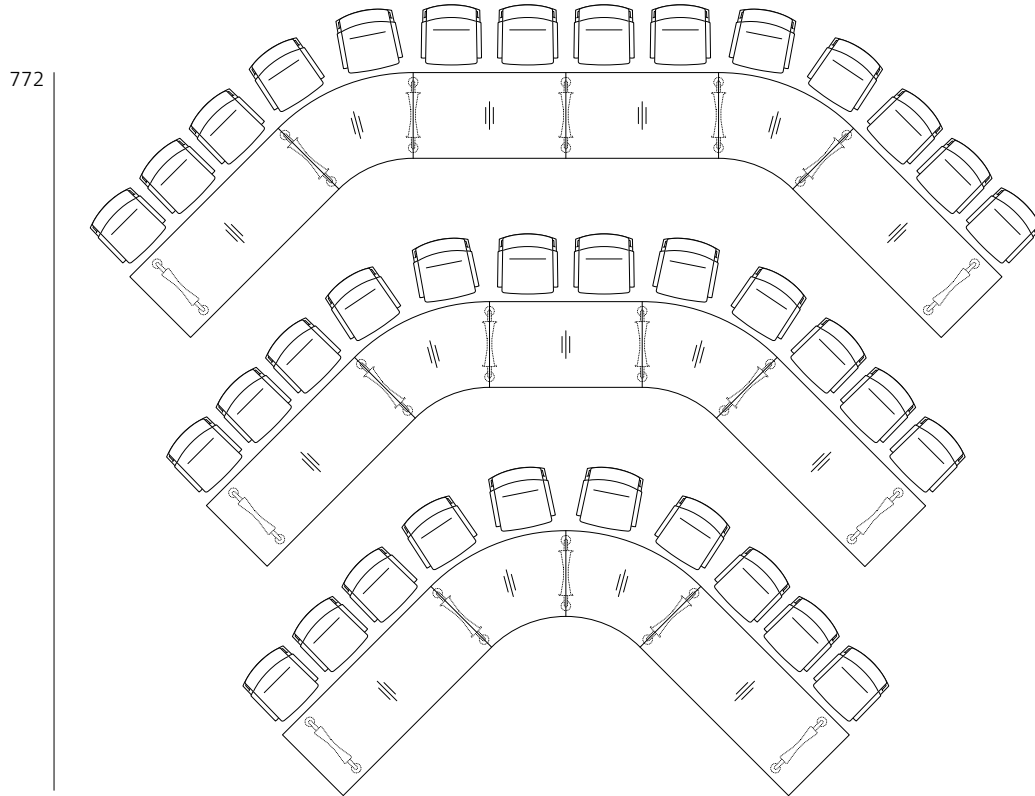


627/61



A 1' A 2 A 3' M 1' M 2 M 3'

			•	•	•
			•	•	•
			•	•	•
			•	•	•
			•	•	•
			•	•	•

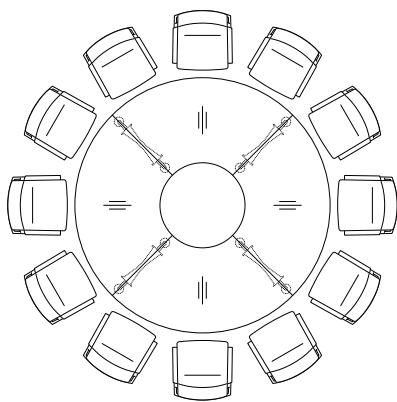


900

740

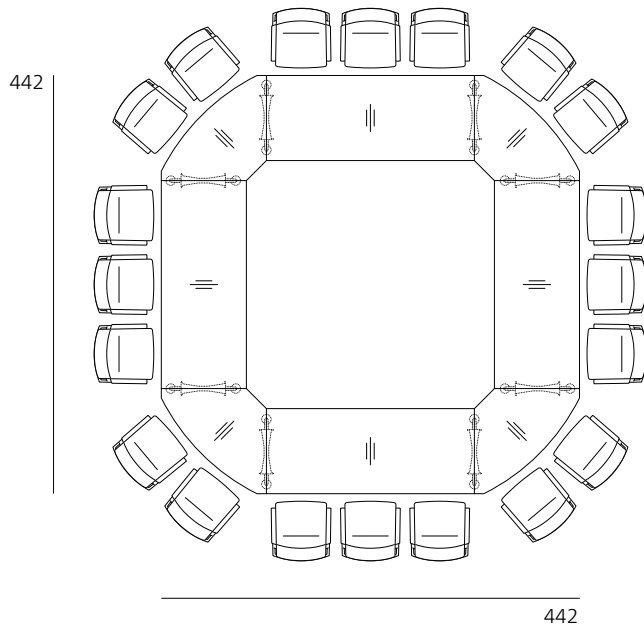
580

36 People
 3 x 620/11, 240x90
 3 x 620/21, 240x90
 3 x 620/31, 160x90
 6 x Special element 153x90, 45°

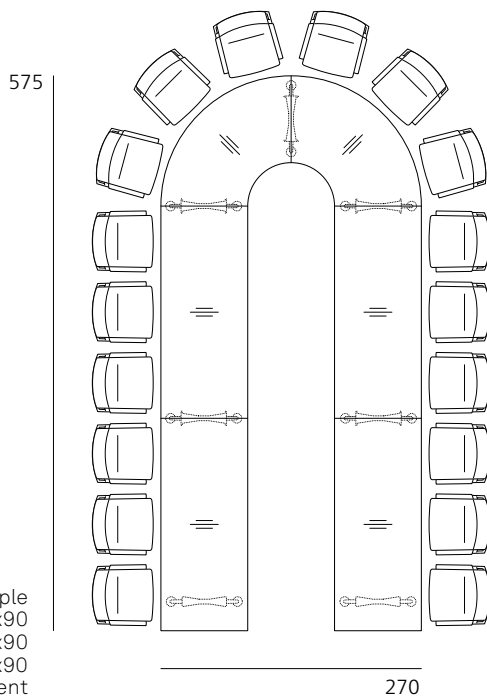


270

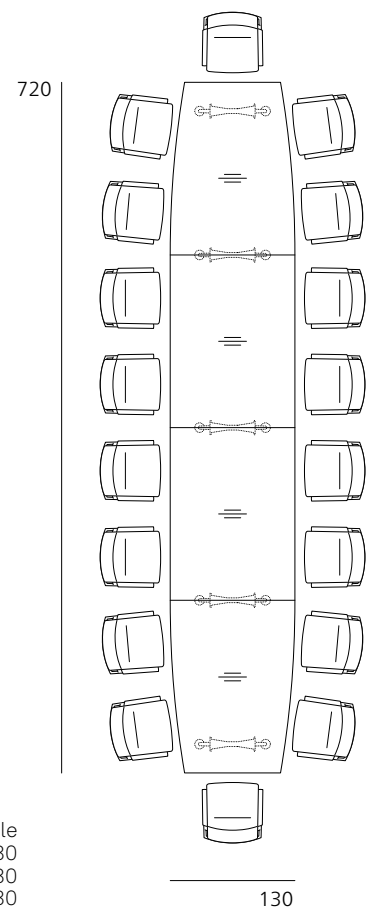
12 People
 4 x Special element 191x90, 90°



20 People
4 x 620/31, 220x90
4 x Special element, 90x10xR227x10x90x30, 90°



18 People
1 x 620/11, 220x90
1 x 620/21, 220x90
2 x 620/31, 220x90
2 x Special element
191x90, 90°



18 People
1 x 627/51, 100/130x180
1 x 627/61, 100/130x180
2 x 620/31, 130x180

636 Range Versa

Design: Wolfgang C. R. Mezger



Technical details

Function

Adaptable table range, which can be configured and assembled without the need for any tools and includes a stand-alone table to complex conference table systems for use in high-quality conference spaces and boardrooms, prestigious meeting and training areas, versatile communications and project rooms. In addition to the rectangular and barrel-shaped stand-alone tables, lots of different system table components allow users to create reversible and extendable table systems in all sorts of configurations. Various table depths and widths as well as surface finishes can be adapted to room sizes, the number of people present, conference types and interior design concepts. Versa tables and table systems can be custom-fitted with state-of-the-art power solutions, stored and moved on four-wheeled trolleys.

Starter and end table top panels, middle elements, stand-alone tables

The frames on the starter and end table top panels are not flush with the edge on one side but are on the other so that the frame can be moved to link up the next segment. Middle elements allow linkage on both sides and on stand-alone tables the position of the frame components is indented on both sides. Which is why stand-alone tables can't be linked together and offer plenty of leg room all the way round.

Frame

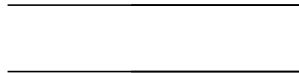
Frame element made of die-cast aluminum, polished, high-luster polished or coated in black or white with a textured matte finish, with two legs that are at an angle and tapered, with table top bearers and four mounting bolts that are connected with one another. For table depths of 120 and 150 cm, with a connecting leaf in the same material. Counter plates for the mounting bolts with quick release (bayonet lock) made of steel, coated gray with a textured matte finish. Frame element and counter plate produce a force-fit, tool-free connection. Height-adjustable multipurpose glides to compensate for differences in the height of the floor of up to 10 mm made of polyamide, optionally with felt for hard floors.

Core material of table top

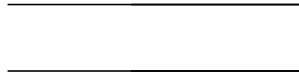
Lightweight table top with finger jointed middle section made of fast-growing lightweight wood with plastic lipping all the way round, straight or with wood lipping, straight or bullnose (double) with impact-resilient profile or with chamfered lipping (in the case of the standardized system panels, the starter and end table top panels are straight on the joining edges, stand-alone tables have chamfered lipping all the way round). Depending on the table top format, with additional reinforcement via a steel underframe, coated gray with a textured matte finish (models 636 with table width ≥ 180 cm and models 638 with table depth ≥ 90 cm with center underframe and table depth 120 cm with double underframe as well as models 637 table width ≥ 160 cm).

Table top group 1 – laminate

Table top thickness 30 mm



Straight plastic lipping



Straight wood lipping

Variant 1

Laminate (single color) from Wilkhahn's color and surface samples with beech lipping, with a natural oiled finish, optionally with color-matched plastic lipping (at a reduced price). Wood decor laminate on request.

Variant 2

Soft matte laminate from Wilkhahn's color and surface samples with oiled, beech lipping, optional with color-matched plastic lipping (for a reduced price). Anti-reflective, soft-touch surface with anti-fingerprint characteristics.

Table top group 2 – veneer

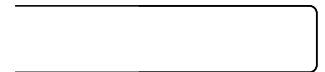
Table top thickness 30 mm

Variant 1

Beech veneer from Wilkhahn's woodstain color samples with wood lipping, as far as possible to color-match the veneer or oak or ash veneer from Wilkhahn's woodstain color samples with lipping which is color-matched with the veneer as far as possible.

Variant 2

Maple, walnut or elm veneer from the Wilkhahn woodstain color samples with lipping, which is color-matched with the veneer as far as possible.



Straight wood lipping



Chamfered wood lipping

Veneer type

As a standard, the veneers are made by slip-match method. Surfaces sealed with clear lacquer: open pore: Oak, ash, walnut and elm veneer closed-pore: maple and beech veneer. Some specific growth features possible.

Modesty panels

Aluminum frame, coated black and covered with black fabric. Tool-free assembly in threaded bushes with star-grip screws.

Standards

The Versa tables comply with the DIN EN 15372 standard.

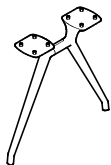


www.tuv.com
ID 109000000

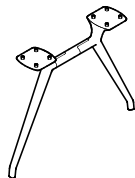
Please note

In the case of system tables, the prices for table tops and frames are listed separately. When ordering, please state the number of feet required. The prices for stand-alone tables include the feet.

Foot sections for table height 73 cm



A-shaped foot section
Model 636, for 80 -
100 cm table depths

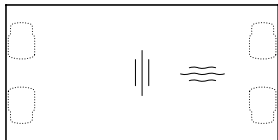


A-shaped foot section
Model 637, for 120 - 150 cm
table depths

Tables	Feet	Counter plate and underframe	Plastic parts
52	Polished aluminum	Coated gray with a textured matte finish	Black
72	High-luster polished aluminum	Coated gray with a textured matte finish	Black
90	Coated with a black textured matte finish (RAL 9011)	Coated gray with a textured matte finish	Black
91	Coated white with a textured matte finish (RAL 9016)	Coated gray with a textured matte finish	Black



Square/rectangular



636/00

Standardized system panel
with mechanisms for attaching the foot sections

SEK

Additional charge/reduced prices

A-shaped foot section mod. 636, coated aluminum 7319
A-shaped foot section mod. 636, polished aluminum 7854
A-shaped foot section mod. 636 High-luster polished aluminum 7854

Plastic lipping all the way round for laminate variant 1 and 2 **per running meter** -220
Lipping chamfered on the long sides, veneer variant 1 **per running meter** 399
Lipping chamfered on the long sides, veneer variant 2 **per running meter** 536

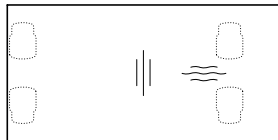
Table top group

	Width	Depth		
		80	90	100
1 Laminate variant 1	80	11183	-	-
	90	11844	12569	-
	100	12516	13314	14133
	120	13839	14763	15729
	160	16485	17724	18921
	180	17819	19173	20538
	200	19131	20643	22145
	220	20465	22092	23751
1 Laminate variant 2	80	12401	-	-
	90	13199	14081	-
	100	14007	14994	15992
	120	15645	16790	17976
	160	18879	20412	21935
	180	20507	22208	23930
	200	22134	24014	25893
	220	23762	25820	27888
2 Veneer variant 1	80	12632	-	-
	90	13503	14438	-
	100	14343	15404	16443
	120	16076	17304	18543
	160	19520	21147	22775
	180	21231	23058	24875
	200	22953	24948	26985
	220	24675	26880	29075
2 Veneer variant 2	80	13346	-	-
	90	14301	15341	-
	100	15236	16391	17556
	120	17115	18491	19856
	160	20895	22659	24444
	180	22796	24770	26765
	200	24665	26870	29064
	220	26555	28959	31353

- not available



Rectangular



636/11

Starter table top panel
with mechanisms for attaching the foot sections

SEK

Additional charge/reduced prices

A-shaped foot section mod. 636, coated aluminum	7319
A-shaped foot section mod. 636, polished aluminum	7854
A-shaped foot section mod. 636 High-luster polished aluminum	7854

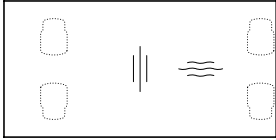
Plastic lipping all the way round for laminate variant 1 and 2 per running meter	-220
Lipping chamfered on 3 sides, veneer variant 1 per running meter	399
Lipping chamfered on 3 sides, veneer variant 2 per running meter	536

Table top group

	Width	Depth		
		80	90	100
1 Laminate variant 1	160	16485	17724	18921
	180	17819	19173	20538
	200	19131	20643	22145
	220	20465	22092	23751
	240	21756	23562	25358
1 Laminate variant 2	160	18879	20412	21935
	180	20507	22208	23930
	200	22134	24014	25893
	220	23762	25820	27888
	240	25379	27605	29873
2 Veneer variant 1	160	19520	21147	22775
	180	21231	23058	24875
	200	22953	24948	26985
	220	24675	26880	29075
	240	26408	28791	31196
2 Veneer variant 2	160	20895	22659	24444
	180	22796	24770	26765
	200	24665	26870	29064
	220	26555	28959	31353
	240	28434	31049	33663



Rectangular



636/12

End table top panel
with mechanisms for attaching the foot sections

SEK

Additional charge/reduced prices

A-shaped foot section mod. 636, coated aluminum

7319

A-shaped foot section mod. 636, polished aluminum

7854

A-shaped foot section mod. 636 High-luster polished aluminum

7854

Plastic lipping all the way round for laminate variant 1 and 2 **per running meter**

-220

Lipping chamfered on 3 sides, veneer variant 1 **per running meter**

399

Lipping chamfered on 3 sides, veneer variant 2 **per running meter**

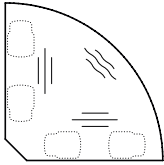
536

Table top group

	Width	Depth		
		80	90	100
1 Laminate variant 1	160	16485	17724	18921
	180	17819	19173	20538
	200	19131	20643	22145
	220	20465	22092	23751
	240	21756	23562	25358
1 Laminate variant 2	160	18879	20412	21935
	180	20507	22208	23930
	200	22134	24014	25893
	220	23762	25820	27888
	240	25379	27605	29873
2 Veneer variant 1	160	19520	21147	22775
	180	21231	23058	24875
	200	22953	24948	26985
	220	24675	26880	29075
	240	26408	28791	31196
2 Veneer variant 2	160	20895	22659	24444
	180	22796	24770	26765
	200	24665	26870	29064
	220	26555	28959	31353
	240	28434	31049	33663



Circular segment 90°



636/14

90° corner panel
with mechanisms for attaching the foot sections

SEK

Additional charge/reduced prices

A-shaped foot section mod. 636, coated aluminum	7319
A-shaped foot section mod. 636, polished aluminum	7854
A-shaped foot section mod. 636 High-luster polished aluminum	7854

Plastic lipping all the way round for laminate variant 1 and 2 per running meter	-220
Lipping chamfered on the long sides, veneer variant 1 per running meter	399
Lipping chamfered on the long sides, veneer variant 2 per running meter	536

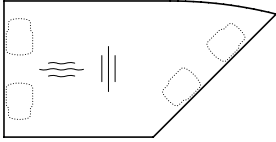
Table top group

	Width	Depth		
		80	90	100
1 Laminate variant 1	133	15162	-	-
	147	-	17042	-
	161	-	-	19100
1 Laminate variant 2	133	17073	-	-
	147	-	19373	-
	161	-	-	21903
2 Veneer variant 1	133	17409	-	-
	147	-	19866	-
	161	-	-	22575
2 Veneer variant 2	133	17819	-	-
	147	-	20349	-
	161	-	-	23142

- not available



Semi-trapezoidal shape



636/20

45° corner panel - right
with mechanisms for attaching the foot sections

SEK

Additional charge/reduced prices

A-shaped foot section mod. 636, coated aluminum 7319
A-shaped foot section mod. 636, polished aluminum 7854
A-shaped foot section mod. 636 High-luster polished aluminum 7854

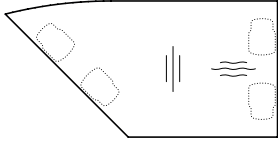
Plastic lipping all the way round for laminate variant 1 and 2 **per running meter** -220
Lipping chamfered on the long sides, veneer variant 1 **per running meter** 399
Lipping chamfered on the long sides, veneer variant 2 **per running meter** 536

Table top group

	Width	Depth		
		80	90	100
1 Laminate variant 1	180	18029	19415	20822
	200	19404	20927	22502
	220	20769	22470	24171
1 Laminate variant 2	180	20727	22460	24192
	200	22418	24339	26261
	220	24098	26198	28308
2 Veneer variant 1	180	22386	24360	26313
	200	24255	26429	28613
	220	26135	28529	30902
2 Veneer variant 2	180	22964	24980	27027
	200	24917	27143	29390
	220	26849	29295	31752



Semi-trapezoidal shape



636/21

45° corner panel - left
with mechanisms for attaching the foot sections

SEK

Additional charge/reduced prices

A-shaped foot section mod. 636, coated aluminum	7319
A-shaped foot section mod. 636, polished aluminum	7854
A-shaped foot section mod. 636 High-luster polished aluminum	7854

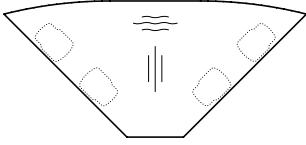
Plastic lipping all the way round for laminate variant 1 and 2 per running meter	-220
Lipping chamfered on the long sides, veneer variant 1 per running meter	399
Lipping chamfered on the long sides, veneer variant 2 per running meter	536

Table top group

	Width	Depth		
		80	90	100
1 Laminate variant 1	180	18029	19415	20822
	200	19404	20927	22502
	220	20769	22470	24171
1 Laminate variant 2	180	20727	22460	24192
	200	22418	24339	26261
	220	24098	26198	28308
2 Veneer variant 1	180	22386	24360	26313
	200	24255	26429	28613
	220	26135	28529	30902
2 Veneer variant 2	180	22964	24980	27027
	200	24917	27143	29390
	220	26849	29295	31752



Trapezoid



636/22

90° front panel
with mechanisms for attaching the foot sections

SEK

Additional charge/reduced prices

A-shaped foot section mod. 636, coated aluminum
A-shaped foot section mod. 636, polished aluminum
A-shaped foot section mod. 636 High-luster polished aluminum

7319
7854
7854

Plastic lipping all the way round for laminate variant 1 and 2 **per running meter**
Lipping chamfered on the long sides, veneer variant 1 **per running meter**
Lipping chamfered on the long sides, veneer variant 2 **per running meter**

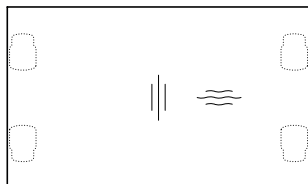
-220
399
536

Table top group

	Width	Depth		
		80	90	100
1 Laminate variant 1	200	19352	20895	22428
	240	22145	23982	25799
1 Laminate variant 2	200	22376	24276	26187
	240	25757	28035	30335
2 Veneer variant 1	200	24224	26376	28550
	240	28014	30597	33180
2 Veneer variant 2	200	24843	27069	29295
	240	28749	31416	34073



Square/rectangular



637/00

Standardized system panel
with mechanisms for attaching the foot sections

SEK

Additional charge/reduced prices

A-shaped foot section mod. 637, coated aluminum	7865
A-shaped foot section mod. 637 polished aluminum	8705
A-shaped foot section mod. 637, high-luster polished aluminum	8705

Plastic lipping all the way round for laminate variant 1 and 2 per running meter	-220
Lipping chamfered on the long sides, veneer variant 1 per running meter	399
Lipping chamfered on the long sides, veneer variant 2 per running meter	536

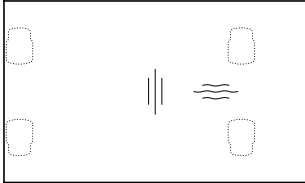
Table top group

	Width	Depth	
		120	150
1 Laminate variant 1	90	18197	-
	120	21452	-
	160	25799	30041
	180	27962	-
	200	30146	-
	220	32319	38042
1 Laminate variant 2	90	20538	-
	120	24581	-
	160	29946	-
	180	32634	-
	200	35322	-
	220	38042	-
2 Veneer variant 1	90	21179	-
	120	25473	-
	160	31206	36845
	180	34073	-
	200	36918	-
	220	39806	47439
2 Veneer variant 2	90	22512	-
	120	27227	-
	160	33506	39680
	180	36656	-
	200	39785	-
	220	42945	51282

- not available



Rectangular



637/11

Starter table top panel
with mechanisms for attaching the foot sections

SEK

Additional charge/reduced prices

A-shaped foot section mod. 637, coated aluminum	7865
A-shaped foot section mod. 637 polished aluminum	8705
A-shaped foot section mod. 637, high-luster polished aluminum	8705

Plastic lipping all the way round for laminate variant 1 and 2 per running meter	-220
Lipping chamfered on 3 sides, veneer variant 1 per running meter	399
Lipping chamfered on 3 sides, veneer variant 2 per running meter	536

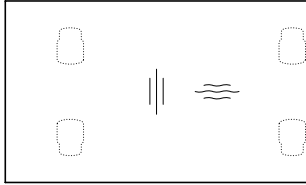
Table top group

	Width	Depth	
		120	150
1 Laminate variant 1	160	25799	-
	180	27962	-
	200	30146	-
	220	32319	38042
	240	34482	40656
1 Laminate variant 2	160	29946	-
	180	32634	-
	200	35322	-
	220	38042	-
	240	40698	-
2 Veneer variant 1	160	31206	-
	180	34073	-
	200	36918	-
	220	39806	47439
	240	42693	50967
2 Veneer variant 2	160	33506	-
	180	36656	-
	200	39785	-
	220	42945	51282
	240	46085	55157

- not available



Rectangular



637/12

End table top panel
with mechanisms for attaching the foot sections

SEK

Additional charge/reduced prices

A-shaped foot section mod. 637, coated aluminum	7865
A-shaped foot section mod. 637 polished aluminum	8705
A-shaped foot section mod. 637, high-luster polished aluminum	8705

Plastic lipping all the way round for laminate variant 1 and 2 per running meter	-220
Lipping chamfered on 3 sides, veneer variant 1 per running meter	399
Lipping chamfered on 3 sides, veneer variant 2 per running meter	536

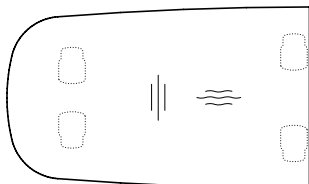
Table top group

	Width	Depth	
		120	150
1 Laminate variant 1	160	25799	-
	180	27962	-
	200	30146	-
	220	32319	38042
	240	34482	40656
1 Laminate variant 2	160	29946	-
	180	32634	-
	200	35322	-
	220	38042	-
	240	40698	-
2 Veneer variant 1	160	31206	-
	180	34073	-
	200	36918	-
	220	39806	47439
	240	42693	50967
2 Veneer variant 2	160	33506	-
	180	36656	-
	200	39785	-
	220	42945	51282
	240	46085	55157

- not available



Semi-barrel shape



637/51

Starter table top panel
with mechanisms for attaching the foot sections

SEK

Additional charge/reduced prices

A-shaped foot section mod. 636 for the short side 107 cm, coated aluminum 7319
A-shaped foot section mod. 636 for the short side 107 cm, polished aluminum 7854
A-shaped foot section mod. 636 for the short side 107 cm, high-luster polished aluminum 7854

A-shaped foot section mod. 637 for the short side 134 cm and joining edges 120/150 cm, coated aluminum 7865

A-shaped foot section mod. 637 for the short side 134 cm and joining edges 120/150 cm, polished aluminum 8705

A-shaped foot section mod. 637 for the short side 134 cm and joining edges 120/150 cm, high-luster polished aluminum 8705

Plastic lipping all the way round for laminate variant 1 and 2 **per running meter** -220

Lipping chamfered on 3 sides, veneer variant 1 **per running meter** 399

Lipping chamfered on 3 sides, veneer variant 2 **per running meter** 536

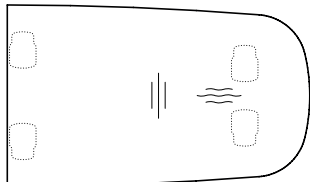
Table top group

	Width	Depth	
		120	150
1 Laminate variant 1	160	28266	-
	180	30429	-
	200	32613	-
	220	34787	40509
	240	36950	43124
1 Laminate variant 2	160	32414	-
	180	35102	-
	200	37790	-
	220	40509	-
	240	43166	-
2 Veneer variant 1	160	33674	-
	180	36540	-
	200	39386	-
	220	42273	49907
	240	45161	53435
2 Veneer variant 2	160	35973	-
	180	39123	-
	200	42252	-
	220	45413	53750
	240	48552	57624

- not available



Semi-barrel shape



637/52

SEK

with mechanisms for attaching the foot sections

Additional charge/reduced prices

A-shaped foot section mod. 636 for the short side 107 cm, coated aluminum	7319
A-shaped foot section mod. 636 for the short side 107 cm, polished aluminum	7854
A-shaped foot section mod. 636 for the short side 107 cm, high-luster polished aluminum	7854

A-shaped foot section mod. 637 for the short side 134 cm and joining edges 120/150 cm, coated aluminum	7865
--------------------------------------------------------------------------------------------------------	------

A-shaped foot section mod. 637 for the short side 134 cm and joining edges 120/150 cm, polished aluminum	8705
----------------------------------------------------------------------------------------------------------	------

A-shaped foot section mod. 637 for the short side 134 cm and joining edges 120/150 cm, high-luster polished aluminum	8705
----------------------------------------------------------------------------------------------------------------------	------

Plastic lipping all the way round for laminate variant 1 and 2 per running meter	-220
-----------------------------------------------------------------------------------------	------

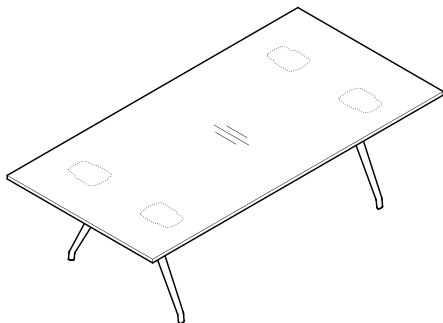
Lipping chamfered on 3 sides, veneer variant 1 per running meter	399
-------------------------------------------------------------------------	-----

Lipping chamfered on 3 sides, veneer variant 2 per running meter	536
-------------------------------------------------------------------------	-----

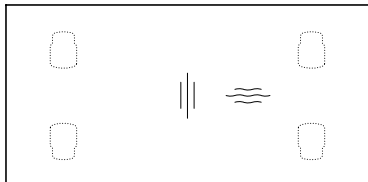
Table top group

	Width	Depth	
		120	150
1 Laminate variant 1	160	28266	-
	180	30429	-
	200	32613	-
	220	34787	40509
	240	36950	43124
1 Laminate variant 2	160	32414	-
	180	35102	-
	200	37790	-
	220	40509	-
	240	43166	-
2 Veneer variant 1	160	33674	-
	180	36540	-
	200	39386	-
	220	42273	49907
	240	45161	53435
2 Veneer variant 2	160	35973	-
	180	39123	-
	200	42252	-
	220	45413	53750
	240	48552	57624

- not available



Rectangular



638/00

Stand-alone table
with two aluminum coated A-shaped foot sections

SEK

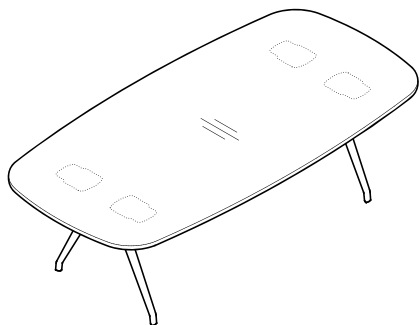
Additional charge/reduced prices

Polished aluminum foot sections, table depth 90 and 100 cm	1071
High-luster polished aluminum foot sections, table depth 90 and 100 cm	1071
Polished aluminum foot sections, table depth 120 cm	1680
High-luster polished aluminum foot sections, table depth 120 cm	1680
Plastic lipping all the way round for laminate variant 1 and 2 per running meter	-220
Lipping chamfered all the way round veneer variant 1 per running meter	399
Lipping chamfered all the way round veneer variant 2 per running meter	536

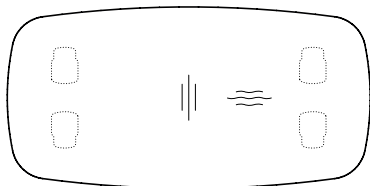
Table top group

	Width	Depth		
		90	100	120
1 Laminate variant 1	180	33810	-	-
	200	35280	36782	-
	220	36729	38388	48059
	240	38210	39984	50253
	260	-	-	52395
1 Laminate variant 2	180	36845	-	-
	200	38651	40530	-
	220	40457	42525	53771
	240	42252	44489	56459
	260	-	-	59147
2 Veneer variant 1	180	37695	-	-
	200	39585	41622	-
	220	41517	43712	55556
	240	43428	45833	58422
	260	-	-	61299
2 Veneer variant 2	180	39407	-	-
	200	41507	43701	-
	220	43596	45990	58674
	240	45686	48300	61835
	260	-	-	64974

- not available



Barrel shape



638/51

Stand-alone table
with two aluminum coated A-shaped foot sections

SEK

Additional charge/reduced prices

Aluminum polished foot sections

1071

High-luster polished aluminum foot sections

1071

Plastic lipping all the way round for laminate variant 1 and 2 **per running meter**

-220

Lipping chamfered all the way round veneer variant 1 **per running meter**

399

Lipping chamfered all the way round veneer variant 2 **per running meter**

536

Table top group

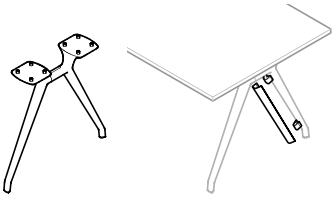
	Width	Depth		
		90	100	120
1 Laminate variant 1	180	33810	-	-
	200	35280	36782	-
	220	36729	38388	48059
	240	38210	39984	50253
	260	-	-	52395
1 Laminate variant 2	180	36845	-	-
	200	38651	40530	-
	220	40457	42525	53771
	240	42252	44489	56459
	260	-	-	59147
2 Veneer variant 1	180	37695	-	-
	200	39585	41622	-
	220	41517	43712	55556
	240	43428	45833	58422
	260	-	-	61299
2 Veneer variant 2	180	39407	-	-
	200	41507	43701	-
	220	43596	45990	58674
	240	45686	48300	61835
	260	-	-	64974

- not available



SEK

A-shaped foot section



636

Model 636, for 80 - 100 cm table depths
Coated aluminum
Polished aluminum
High-luster polished aluminum

SEK

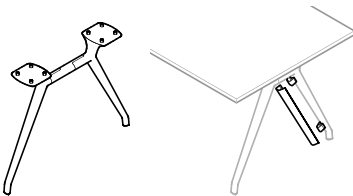
7319
7854
7854

Additional charge/reduced prices

Vertical cable management in white with a textured matte finish, black with a textured matte finish, or dark gray with a textured matte finish

1722

A-shaped foot section



637

Model 637, for 120 - 150 cm table depths
Coated aluminum
Polished aluminum
High-luster polished aluminum

SEK

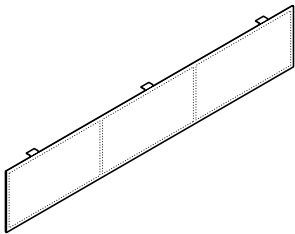
7865
8705
8705

Additional charge/reduced prices

Vertical cable management in white with a textured matte finish, black with a textured matte finish, or dark gray with a textured matte finish

1722

Modesty panel



639

Aluminum frame, coated black
covered with black fabric

Table top shape
Rectangular

Table top width

Modesty panel width

80
90
100
120
160
180
200
220
240
260

79
89
99
119
159
178
199
219
239
259

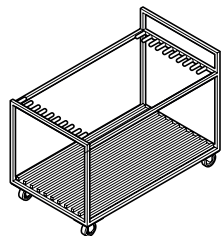
4704
4788
4914
5387
6405
6615
6867
7319
7760
8064

Modesty panels for corner and front panels on request.



SEK

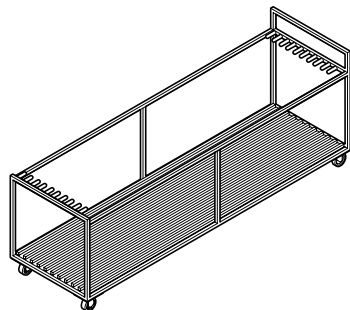
Four-wheeled trolley



636/1
72 x 126 x H94
for 5 table tops with 80 to 120 cm table depths
and maximum table top width of 180 cm
as well as 5 modesty panels

20570

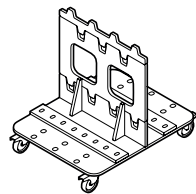
Four-wheeled trolley



636/2
72 x 246 x H94
for 5 table tops with 80 to 150 cm table depths
and a maximum table top width of 180 to 240 cm
as well as 5 modesty panels

23331

Four-wheeled trolley



636/3
80 x 98, H 47
for 4 A-shaped foot sections models 636 and 637

16443





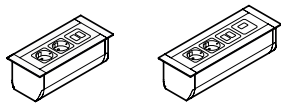
Integrated square techni-station consisting of:

SEK

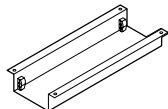
Integrated techni-station Compact set consisting of:

SEK

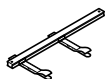
Integrated techni-station square 701/61 or 701/71



Cable cover for techni-station



Cable holder under the table top with hook and loop strap



Integrated techni-station Square set 701/61 with 3 modules:

6164

2 x power supply module (when ordering please state the local standard) with 40 cm supply lead, mod. 708/8
1 x data module with 2 x RJ 45 jacks (category 6, shielded) as a thru-type coupling, each with 300 cm of patch cable or optionally with USB charger type A + type C with Smart IC and PD 2.0 to recharge up to two mobile devices.

Set integrated square techni-station 701/71 with 4 modules:

7487

2 x power supply module (when ordering please state the local standard) with 40 cm supply lead, mod. 708/8
1 x data module with 2 x RJ 45 connector (category 6, shielded) as thru-type coupling, each with 300 cm patch cable
1 x HDMI jack as thru-type coupling, with 300 cm cable

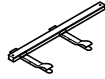
Round or square installation frame compact



Multimedia



Cable holder under the table top with hook and loop strap



Set integrated techni-station Compact 701/95 with slot for cable outlet chrome matte and surface with brushed strip/brushed profile

1754

Integrated techni-station Compact set 701/95 with wireless charging slot:

4022

1 x slot with wireless charging module (5 watt, Qi compliant) with supply lead approx. 180 cm and power supply unit

Integrated techni-station Compact set 701/95 with power supply module:

2363

1 x power supply module (when ordering please state the local standard) with 40 cm supply lead, mod. 708/8
2 x slots with cover for optional Keystone modules

Integrated techni-station Compact set 701/95 with power supply module and USB port*:

3833

1 x power supply module (when ordering please state the local standard) with 40 cm supply lead, mod. 708/8
1 x USB port with Smart IC (charging current 2A max.)
1 x slot with cover for optional Keystone modules

Additional charge/reduced prices

708/8 supply lead



Length approx. 200 cm
Length approx. 300 cm
Length approx. 500 cm

221
263
357

Cable harness covered with black textile sleeving

1376



Additional charge/reduced prices

Keystone module RJ 45 connector (category 6) as a thru-type coupling, without cables

147

Keystone module, HDMI jack as a thru-type coupling, without cables

284

708/8 supply lead



Length approx. 200 cm
Length approx. 300 cm
Length approx. 500 cm

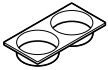


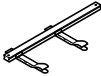





221
263
357

Cable harness covered with black textile sleeving

1376





Integrated techni-station Compact Duo set consisting of:	SEK	Cable outlet set consisting of:	SEK
Rectangular installation frame compact duo 		Cable outlet 707/1 	
Multimedia 			
Cable holder under the table top with hook and loop strap 		Cable holder under the table top with hook and loop strap 	
Cable clip for the table legs (2) 			
Set Integrated techni-station Compact Duo 701/96 with slot for cable outlet chrome matte, with surface with brushed strip/brushed profile*	1197	Cable outlet set 707/1 Black plastic, Ø 80 mm	1575
Integrated techni-station Compact Duo set 701/96 with wireless charging slot*:	3423		
1 x slot with wireless charging module (5 watt, Qi compliant) with supply lead approx. 180 cm and power supply unit			
Integrated techni-station Compact Duo set 701/96 with power supply module*:	1785		
1 x power supply module (when ordering please state the local standard) with 40 cm supply lead, mod. 708/8 2 x slots with cover for optional Keystone modules			
Integrated techni-station Compact Duo set 701/96 with power supply module and USB port*:	3224		
1 x power supply module (when ordering please state the local standard) with 40 cm supply lead, mod. 708/8 1 x USB port with Smart IC (charging current 2A max.) 1 x slot with cover for optional Keystone modules			
Additional charge/reduced prices		Additional charge/reduced prices	
Keystone module RJ 45 connector (category 6) as a thru-type coupling, without cables	147	Cable harness covered with black textile sleeving 	1407
Keystone module, HDMI jack as a thru-type coupling, without cables	284		
708/8 supply lead			
 Length approx. 200 cm	221		
Length approx. 300 cm	263		
Length approx. 500 cm	357		
Cable harness covered with black textile sleeving 	1376		

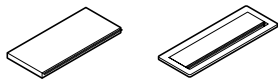
* The price is for one module. Add the prices of two modules to obtain the price for a set.

All prices include section cut out of table
Further details from page 308
For individual cable outlets see accessories page 251

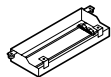


Cable lid set consisting of:

Cable lid Executive or Basic



Cable channel to integrate the socket strip.



Cable holder under the table top with hook and loop strap



Cable clip for the table legs (2)



Executive cable lid set 150 x 300 mm

Table top group 1, laminate variant 1 and 2

14700

Table top group 2, veneer variant 1 and 2 incl. fastening material for socket strip, please order socket strip separately, can be fitted at 15° or vertically (please state angle when ordering)

17640

Basic cable lid set 120 x 300 mm

incl. fastening material for socket strip, please order socket strip separately, can be fitted at 15° or vertically (please state angle when ordering)

6552

Socket strips for cable lid set

SEK

Mod. 708/1 socket strip with 3 modules

630

3 x power supply modules (when ordering state local standard) please order supply/connecting lead separately



Mod. 708/2 socket strip with 3 modules:

2951

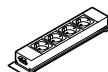
2 x power supply modules (when ordering please state the local standard)
Please order supply-/connecting cable separately
1 x data module with 2 x RJ45 connectors (category 6, shielded) with patch cables permanently connected, approx. 350 cm long or optionally with 1 x slot with 2 x USB ports (charging current 2.1A) to recharge up to two mobile devices



Mod. 708/4 socket strip with 4 modules:

735

4 x power supply modules (please state local standard when ordering)
Please order supply/connecting lead separately



Mod. 708/5 socket strip with 4 modules:

7518

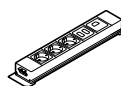
2 x power supply modules (when ordering please state the local standard)
please order supply/connecting cable separately
1 x data module with 2 x RJ45 jacks (category 6, shielded) with permanent patch cables approx. 350 cm long permanently attached
1 x VGA jack (15 pin D-sub) + 3.5 mm stereo jack or optionally HDMI jack with permanently attached cables, length approx. 300 cm



Mod. 708/6 socket strip with 5 modules:

4463

3 x power supply modules (state local standard when ordering)
Please order power supply/connecting cable separately
1 x data module with 2 x RJ45 connectors (category 6 shielded)
1 x data module with 1 x RJ45 jack (category 6 shielded) with permanently attached patch cables approx. 350 cm long



Additional charge/reduced prices

Cable harness covered with black textile sleeving

1407



Additional charge/reduced prices

708/8 supply lead



Length approx. 200 cm
Length approx. 300 cm
Length approx. 500 cm

221
263
357

708/9 extension lead



Length approx. 200 cm
Length approx. 300 cm

200
252



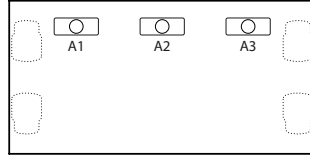


□ Integrated techni-station square compact duo or cable lid

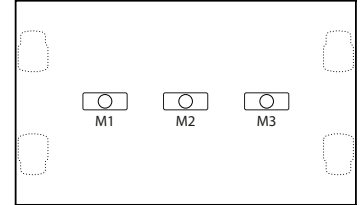
○ Integrated techni-station compact, compact duo or cable outlet

A maximum of two built-in component sets are to be integrated per table. Possible positions: Either A/M 1 and A/M 3 or A/M 2.

636/00



637/00



Set	Mounting position
Integrated techni-station square	701/61 701/71
Cable lid Executive Basic	
Integrated techni-station compact	701/95
Integrated techni-station compact duo	701/96
Cable outlet set	707/1

A1¹ A2 A3¹

M1¹ M2 M3¹

• •² •

• • •

• •² •

• • •

• • •

• • •

• • •

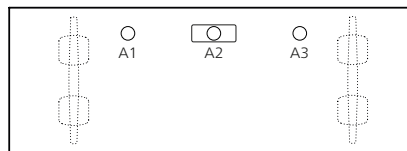
• • •

• • •

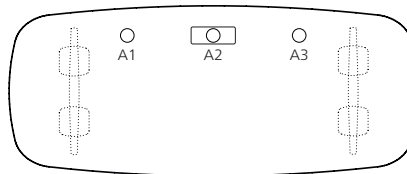
• • •

Table depth 90 – 100 cm

638/00



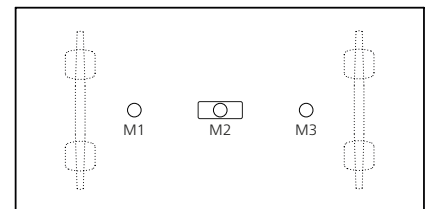
638/51



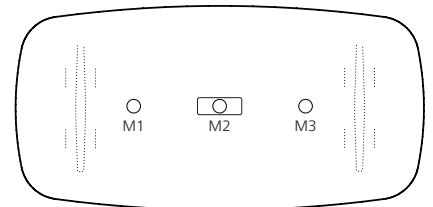
A1⁴ A2 A3⁴

Table depth 120 cm

638/00



638/51



M1 M2 M3

– • –

– • –

– • –

– • –

• • •

• • •

• • •

• • •

• • •

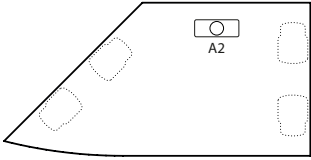
• • •

¹ from table width 180 cm
² from 100 cm table width
³ from table depth 100 cm

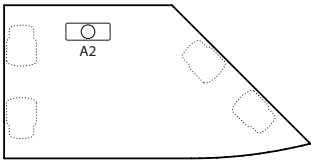
⁴ from table width 200 cm
• available
– not available



636/20



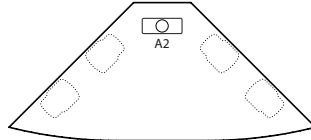
636/21



A1 A2 A3

-	•	-
-	•	-
-	•	-
-	•	-
-	•	-

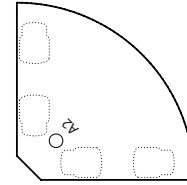
636/22



A1 A2 A3

-	• ³	-
-	• ³	-
-	•	-
-	•	-
-	•	-

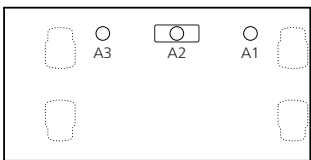
636/14



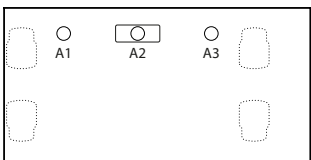
A1 A2 A3

-	-	-
-	-	-
-	•	-
-	•	-
-	•	-

636/11



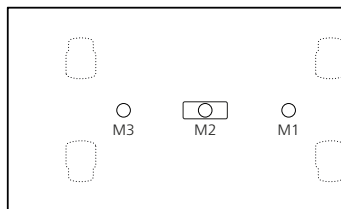
636/12



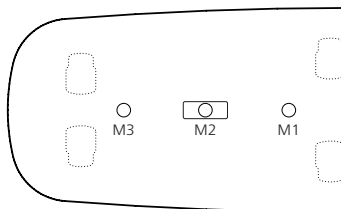
A1 A2 A3

-	•	-
-	•	-
•	•	•
•	•	•
•	•	•

637/11



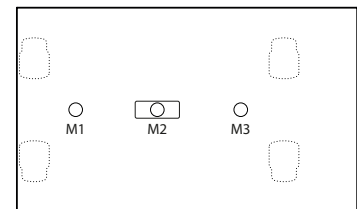
637/51



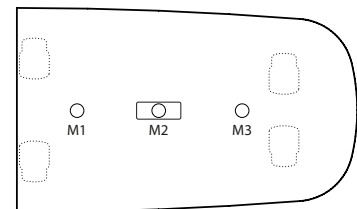
M1 M2 M3

-	•	-
-	•	-
•	•	•
•	•	•
•	•	•

637/12

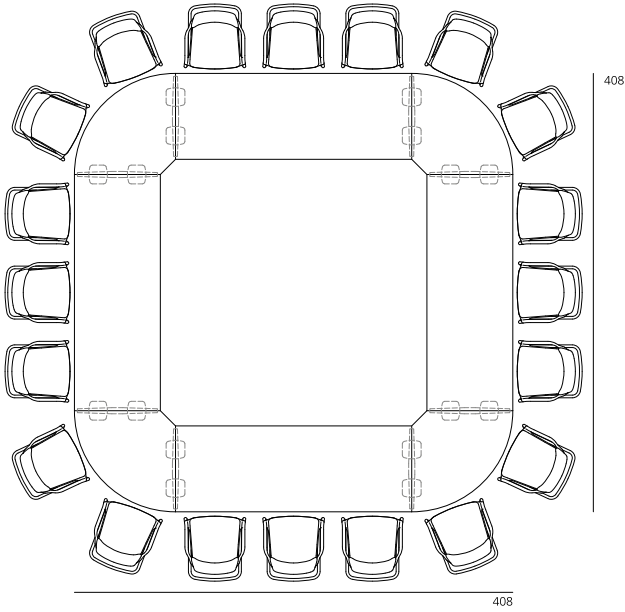


637/52

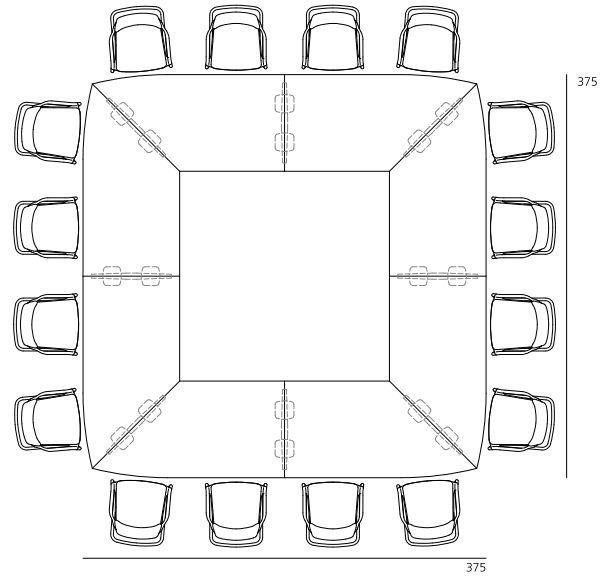


M1 M2 M3

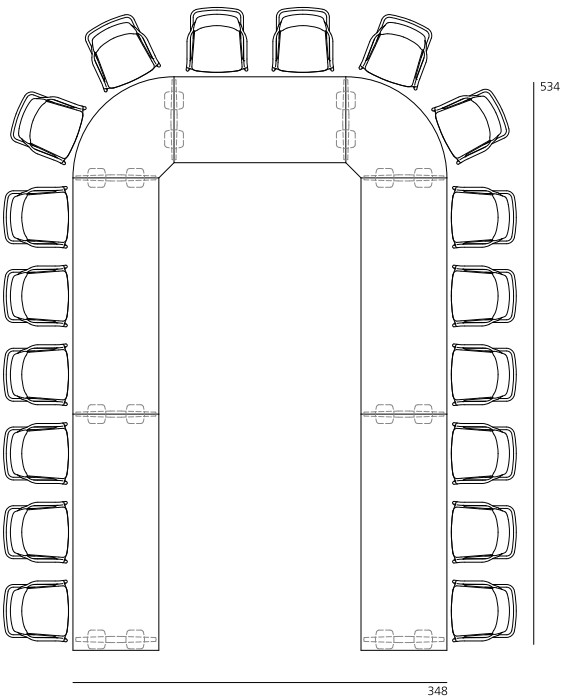
-	•	-
-	•	-
•	•	•
•	•	•
•	•	•



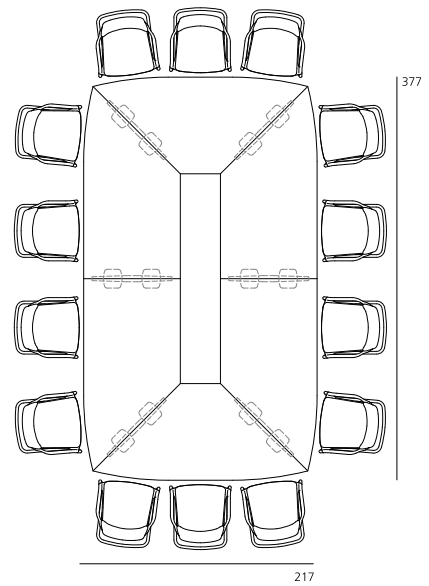
20 People
4 x 636/00, 220x80
4 x 636/14, 133x80, 90°
8 x A-shaped foot section 636



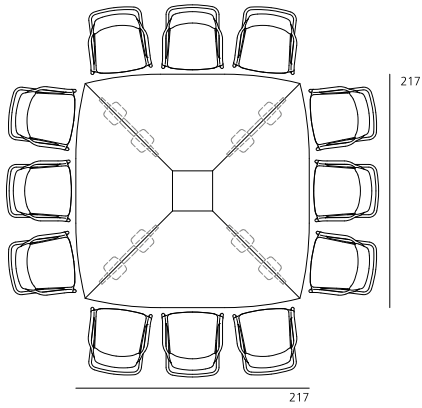
16 People
4 x 636/20, 180x90
4 x 636/21, 180x90
8 x A-shaped foot section 636



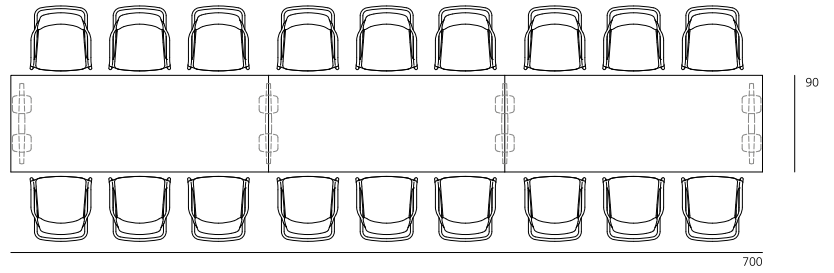
18 People
2 x 636/00, 220x80
1 x 636/00, 160x80
2 x 636/00, 220x80
2 x 636/14, 133x80, 90°
8 x A-shaped foot section 636



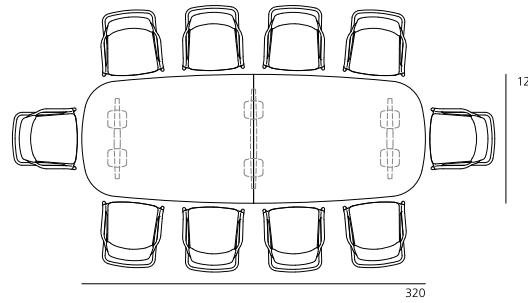
14 People
2 x 636/20, 180x90
2 x 636/21, 180x90
2 x 636/22, 200x90
6 x A-shaped foot section 636



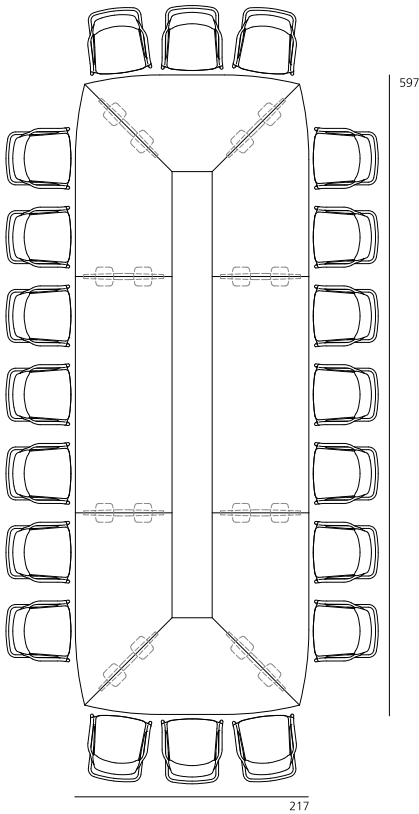
12 People
4 x 636/22, 200x90
4 x A-shaped foot section 636



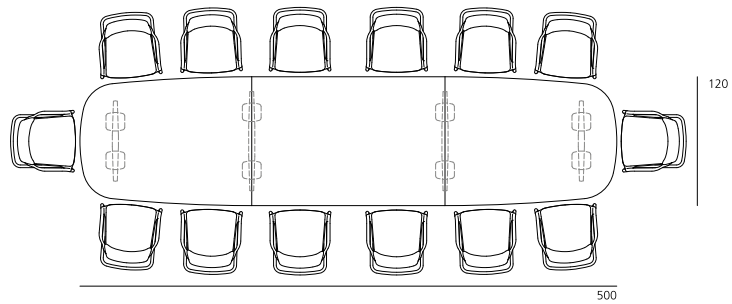
18 People
1 x 636/00, 220x90
1 x 636/11, 240x90
1 x 636/12, 240x90
4 x A-shaped foot section 636



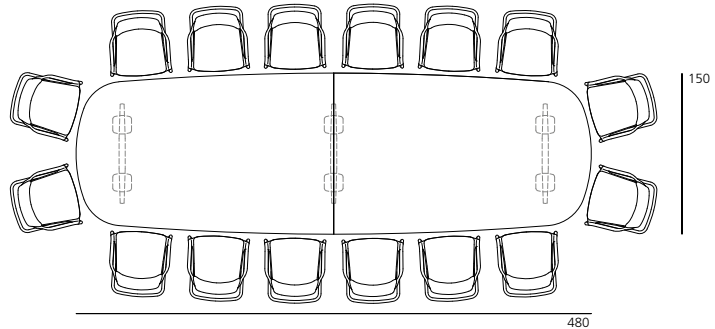
10 People
1 x 637/51, 160x120
1 x 637/52, 160x120
3 x A-shaped foot section 637



20 People
2 x 636/00, 220x90
2 x 636/20, 180x90
2 x 636/21, 180x90
2 x 636/22, 200x90
3 x A-shaped foot section 636



14 People
1 x 637/51, 160x120
1 x 637/00, 180x120
1 x 637/52, 160x120
4 x A-shaped foot section 637



16 People
1 x 637/51, 240x150, 1 x 637/52, 240x150
3 x A-shaped foot section 637

661 Range

Height-adjustable Travis



Technical details

Function

Electric height-adjustable tables now complement the modular Travis table system. From a seating height of at least 71 cm, the tables are precision adjustable to a standing height of 118 cm max. People can easily alternate between sitting and standing at the table at the touch of a button. In terms of ergonomics, changing posture at conferences and desks is a good idea and this feature makes it easy.

Frame

Steel, T-shaped base, bright chrome-plated or in silver satin finish, or black coated. Telescopic steel table column, bright chrome-plated, or in silver satin finish, or black coated; telescopic section always chrome plated. Steel crossbeam coated in a silver satin finish or black. Underframe facings at the front edges are the same as the table column's surface finish. Black polyamide glides, optionally with felt inserts (for hard floorings). Frame electrically height adjustable from 71 to 118 cm, supply lead 300 cm, 150 cm of which has a black textile sleeving.

Core material of table top

Plywood, depending on the surface with straight, color-matched plastic lipping all the way round or with straight, color-matched wood lipping. MDF (medium density fiberboard) only in conjunction with veneer with color-matched, chamfered wood lipping all the way round.

Table top group 1 – veneered top and bottom with laminate

Table top thickness 26 mm, Laminate from the Wilkhahn color and surface samples with plastic lipping color-matched with the surface. (Only straight edges possible!)



Straight

Table top group 2 – veneered top and bottom

Table top thickness 26 mm

Variant 1:

Beech, oak or ash veneer from the Wilkhahn woodstain color samples (exception: natural ash not possible with chamfered lipping) with wood lipping color-matched with the veneer as far as possible.

Variant 2:

Maple (exception: maple with a natural finish not possible with chamfered lipping), walnut or elm veneer from the Wilkhahn woodstain color samples with wood lipping color-matched as far as possible with the veneer.

Further finishes for the formats shown in the price list are available on request.



Chamfered



Straight



Bullnose double

Veneer type

As a standard, the veneers are made by slip-match method. Surfaces sealed with clear lacquer:
open-pore:
Oak, ash, walnut and elm veneer
closed-pore:
maple and beech veneer. Some specific growth features possible.

Tables	Foot section	Telescopic table column	Crossbeams	Underframe facings
51	Bright chrome-plated	Silver satin finish, coated black or black with textured matte finish or with bright chrome plating	Silver satin finish, coated black or black with textured matte finish	Bright chrome-plated
53	Coated black (RAL9011)	Coated black	Coated black	Coated black
60	Coated with a silver satin finish (RAL9006)	Coated with a silver satin finish	Coated with a silver satin finish	Coated with a silver satin finish

Height-adjustable Travis
Tables

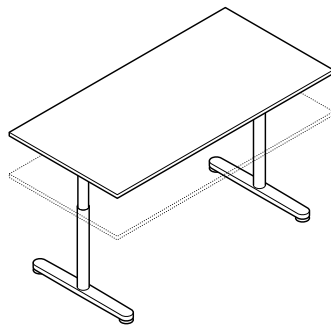
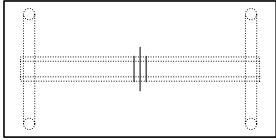


Table top group

1 Laminate straight edge/lipping	2 Veneer variant 1 straight/bullnose (double) edge/lipping	2 Veneer variant 1 chamfered edge/ lipping	2 Veneer variant 2 straight/bullnose (double) edge/lipping	2 Veneer variant 2 chamfered edge/ lipping
SEK	SEK	SEK	SEK	SEK

Rectangular



661/41

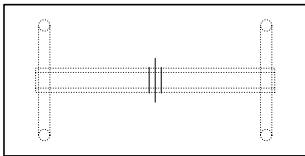
90 x 180, H 71-118
Electrically adjustable height (71-118 cm)

Additional charge/reduced prices

Bright chrome-plated aluminum T-shaped base
Chrome-plated telescopic lifting column

26586	31122	35669	32928	37475
3969 1985	3969 1985	3969 1985	3969 1985	3969 1985

Rectangular



661/41

100 x 200, H 71-118
Electrically adjustable height (71-118 cm)

Additional charge/reduced prices

Bright chrome-plated aluminum T-shaped base
Chrome-plated telescopic lifting column

27279	32991	38010	34944	39963
3969 1985	3969 1985	3969 1985	3969 1985	3969 1985

780 Range Insit

Wolfgang C.R. Mezger



Technical details

Upholstered benches with backrests and benches without backrests

Function

Multipurpose upholstered benches with and benches without backrests with coordinating tables for customer service areas, foyers, lobbies, waiting spaces, areas in the middle of rooms, cross-over spaces, co-working spaces and company restaurants.

When sitting vertically at a seating height of 45 cm, people can work, communicate, eat and drink at normal table heights and chairs can be added. The integrative design turns each Insit into an individually scalable attractive sculpture. By using connectors and side tables, the elements create a versatile system that can be linked to form complex configurations.

The range of two-, two-and-a-half and three-seaters includes benches that are straight sloping or linked at 90-degree angles at the corners and that come with linear backrests or ones curved on one or both sides or that change direction, as well as benches without backrests that can be used on both sides.

Frame

Polished or high-luster polished die-cast aluminum A-line base frame or coated white, black or with a silver satin finish. Table top bearer to connect the seat made of black coated sheet steel. Black polyamide glides as the standard version for carpets; optionally with felt insert for hard flooring.

Seat and backrest

Wooden frame design with integrated panel made of beech, upholstered all the way round with contour-cut foam, seat cushioning made of cold foam with a fleece overlay, fully covered in fabric or leather.

Backrest: Wooden frame design made of beech, upholstered with contour-cut foam all the way round, back cushioning made of contour-cut foam, fully covered with fabric or leather, depending on the model linear, sloping or curved on one or both sides or with a change of direction, optional with a 30 cm higher backrest (only in linear models). Benches without backrests (models 782/6 and 783/6).

Inline connectors

Models 780 set for linear, or back-to-back linkage of the benches (without rear panel and side panel screens) made of sheet steel, coated black, with four, black star-grip screws. (One set for each bench linked).

Model 781 set for linear linkage of the benches (with rear panel screen connected, not possible with side panel) made of sheet steel, coated black, with four, black star-grip screws (one set for each bench linked).

Screens (rear- and side-screens)

Function

Modular set of fully upholstered and covered stand-alone rear panels and combinations of rear- and side-panels to provide visual and acoustic privacy as required and to divide up stand-alone benches and linked items of sectional seating. Maximum flexibility in terms of functionality and uses because they can be retrofitted and dismantled later on. Depending on the bench model, shelves and writing ledges can also be slotted/fitted on to provide privacy at the rear, or divide up seating at the rear and sides, all the way to privacy options for a sofa on three sides to allow deep work. Or C-shaped options with benches facing one another create a compartment-like booth.

Material

A solid pine structure with perforated acoustic fleece, fully upholstered with cut foam and covered. Tapered edges with double stitching all the way round for stylish linkage in a straight line or at an angle. In addition to the Insit upholstery materials and the Racer fabric group 37, also available with Hush Stripe 40 fabric with vertical stripes at 40 mm distance from one another.

Clips

Linear and angular clips made of rectangular, tubular steel profiles, coated black, with integrated set screws to adjust the height.

Tables, shelves and corner writing ledges

Frames and clips

Models 780/1, 780/2, 780/3, 780/4

Steel disc base, (diameter models 780/1, 780/2 and 780/4 Ø 51 cm, model 780/3 Ø 95 cm) with cover made of sheet steel coated white, black or in a silver satin finish or optionally brushed stainless steel or bright chrome-plated. Steel table column to match the disc base with cover coated white, black or in a silver satin finish or optionally brushed or bright chrome-plated stainless steel. Sheet steel table top bearer, coated black.

Model 780/9

Polished or high-luster polished die-cast aluminum A-shaped base frame or coated white, black or with a silver satin finish. Table top bearer to connect the tabletop made of sheet steel coated black. Black polyamide glides as the standard version for carpets; optionally with felt insert for hard flooring.

Models 780/10 and 780/12

Clips for the connecting tables linearly/at an angle with braces made of flat steel, coated black, with four handle screws for fixed linkage of tables and benches, model 780/12 additionally with A-shaped, diagonally aligned foot section made of die-cast aluminum, polished or high-luster polished, or in a white, black or silver satin finish. Table top bearer to connect the table top made of sheet steel coated black.

Upholstered benches with backrests and benches without backrests

Foot section

48	Coated white (RAL 9016)
51	Bright chrome-plated
53	Coated black (RAL 9011)
60	Coated with a silver satin finish (RAL 9006)
72	High-luster polished aluminum

Tables

Disc base with cover

48	Coated white (RAL 9016)
51	Bright chrome-plated
53	Coated black (RAL 9011)
60	Coated with a silver satin finish (RAL 9006)
64	Brushed stainless steel

Table column

Coated white
Bright chrome-plated
Coated black
Coated with a silver satin finish
Brushed stainless steel

Table top bearers

Coated black
Coated black
Coated black
Coated black
Coated black



Black polyamide glides as the standard version for carpets; optionally with felt insert for hard flooring.

Model 780/11

Clip for the side table with connecting profiles made of tubular steel coated black, to connect to the bench at the side.

Model 780/13

Clip for the shelf made of sheet steel coated black to slot between Insite Screen's rear and side panel.

Model 780/14

Clip for the corner writing ledge made of rectangular tubular steel profile, coated black, to place between the bench and Insite Screen's side panel.

Core material of table top

Plywood with straight wood or plastic lipping all the way round or MDF table top with chamfered lipping all the way round

Core material of corner writing ledge

Made of birch plywood, 12 mm thick, with straight edging, with laminate variant 1 and 2 or wood veneer, variant 1 and 2, or table top group 7 made of 12 mm solid-core HPL, chamfered edging.

Table top group 1 – laminate

Table top thickness 26 mm
table height 74.5 cm

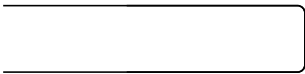
Variant 1

Laminate (single color) based on Wilkhahn's color and surface samples with straight wood edging or optionally bullnose (double) with impact-resilient profile (for an additional charge)



Straight wood lipping

Wood decor laminate from the Wilkhahn color and surface samples with straight, color-matched plastic edging



Straight plastic lipping

Variant 2

Soft matte laminate from the Wilkhahn color and surface samples with straight wood lipping. Anti-reflective, soft-touch surface with anti-fingerprint characteristics.



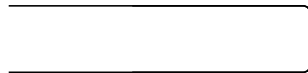
Straight wood lipping

Table top group 2 – veneer

Table top thickness 26 mm
table height 74.5 cm



E2 – 5 chamfered wood lipping, 12 mm



Straight wood lipping

Variant 1

Beech, oak or ash veneer from Wilkhahn woodstain color samples with straight or chamfered wood lipping (at an extra charge).

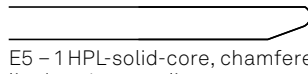
Variant 2

Maple, walnut or elm veneer from Wilkhahn woodstain color samples with straight or chamfered wood lipping (at an extra charge).

Table top group 7 - black/white through-dyed

Table top thickness 12 mm
table height 73 cm

Table top made of through-dyed HPL (High Pressure Laminate) in black or white, chamfered lipping.



E5 – 1 HPL-solid-core, chamfered lipping, 4 mm radius

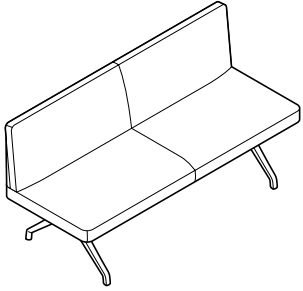
Monitor mount

made of sheet steel, length 105 cm, black or silver satin finish, can be clamped to long side panel (mod. 781/20), retrofittable, reversible. With vertical C-profile for cable routing, with 2 cable apertures Ø 60 mm and securing bracket screwed at the bottom. Universal monitor mount with VESA hole pattern (WxH): 200x200 mm, 200x100 mm, 100x100 mm, 75x75 mm. Maximum screen size 40".



Upholstered bench with backrest

84/115 H165 H64
45



782/5

165 cm wide
2-seater
linear backrest
Coated aluminum foot section

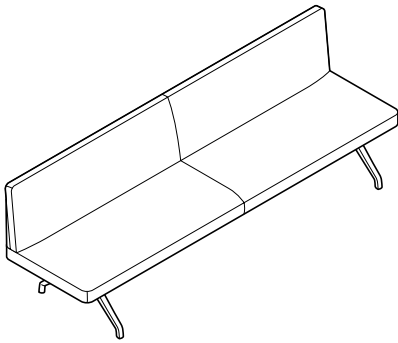
Additional charge/reduced prices

High backrest
Polished aluminum foot section
High-luster polished aluminum foot section
Inline connector see accessories page 301

	51	60		
	54	64	91	
	58	65	92	74
		66		
		68		
SEK	SEK	SEK	SEK	SEK
32088	35049	39123	46904	
5975	7277	9093	10007	
819	819	819	819	
1260	1260	1260	1260	
•	•	•	•	•

Upholstered bench with backrest

84/115 H240 H64
45



783/5

240 cm wide
3-seater
linear backrest
Coated aluminum foot section

Additional charge/reduced prices

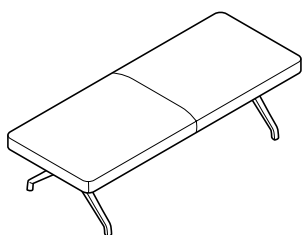
High backrest
Polished aluminum foot section
High-luster polished aluminum foot section
Inline connector see accessories page 301

	51	60		
	54	64	91	
	58	65	92	74
		66		
		68		
SEK	SEK	SEK	SEK	SEK
37118	41265	46977	58643	
6993	8673	11036	13451	
819	819	819	819	
1260	1260	1260	1260	
•	•	•	•	•

• available



Bench without backrest
 □45 ■165 ■64



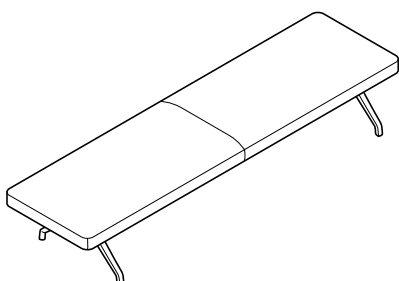
782/6
 165 cm wide
 2-seater
 Coated aluminum foot section

Additional charge/reduced prices
 Polished aluminum foot section
 High-luster polished aluminum foot section

Inline connector see accessories page 301

	51	60	64	65	66	68	91	92	74
	51	60	64	65	66	68	91	92	74
	54								
	58								
SEK	SEK	SEK	SEK	SEK	SEK	SEK	SEK	SEK	SEK
20706	22250	24392	28025						
819	819	819	819						
1260	1260	1260	1260						
•	•	•	•						

Bench without backrest
 □45 ■240 ■64



783/6
 240 cm wide
 3-seater
 Coated aluminum foot section

Additional charge/reduced prices
 Polished aluminum foot section
 High-luster polished aluminum foot section

Inline connector see accessories page 301

	51	60	64	65	66	68	91	92	74
	51	60	64	65	66	68	91	92	74
	54								
	58								
SEK	SEK	SEK	SEK	SEK	SEK	SEK	SEK	SEK	SEK
24602	26576	29295	34398						
819	819	819	819						
1260	1260	1260	1260						
•	•	•	•						

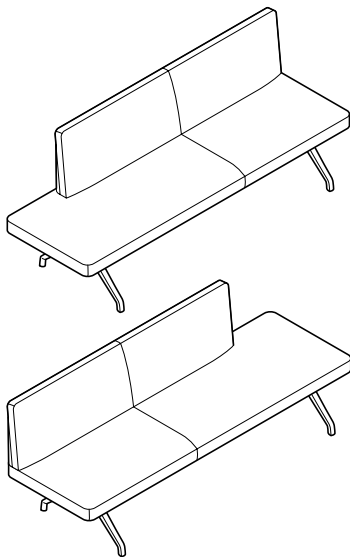
• available



Upholstered bench with backrest

84/115 H203 H64

45



782/51

203 cm wide
2.5-seater
linear backrest with open end right or left
Coated aluminum foot section

Additional charge/reduced prices

High backrest

Polished aluminum foot section
High-luster polished aluminum foot section

Inline connector see accessories page 301

51
54
58

60
64
65
66
68

91
92

74

SEK SEK SEK SEK

33569 36792 41223 49581

6153 7466 9282 10122

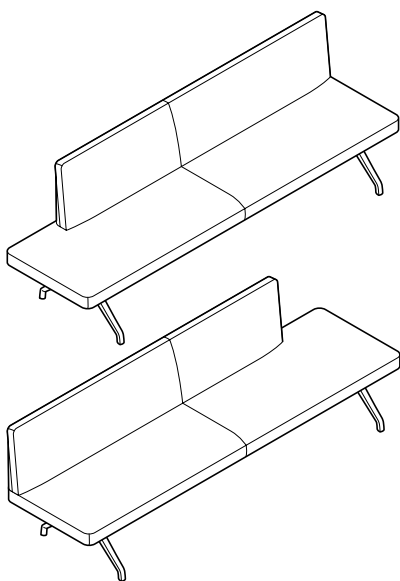
819 819 819 819
1260 1260 1260 1260

• • • •

Upholstered bench with backrest

84/115 H240 H64

45



783/51

240 cm wide
3-seater
linear backrest with open end right or left
Coated aluminum foot section

Additional charge/reduced prices

High backrest

Polished aluminum foot section
High-luster polished aluminum foot section

Inline connector see accessories page 301

51
54
58

60
64
65
66
68

91
92

74

SEK SEK SEK SEK

35595 39281 44342 55304

6395 7707 9524 11844

819 819 819 819
1260 1260 1260 1260

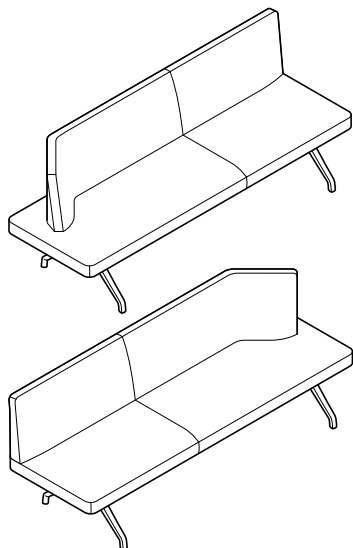
• • • •

• available



Upholstered bench with backrest

84 203 64
45



782/52

203 cm wide
2.5-seater
backrest slopes to the right or left
Coated aluminum foot section

Additional charge/reduced prices

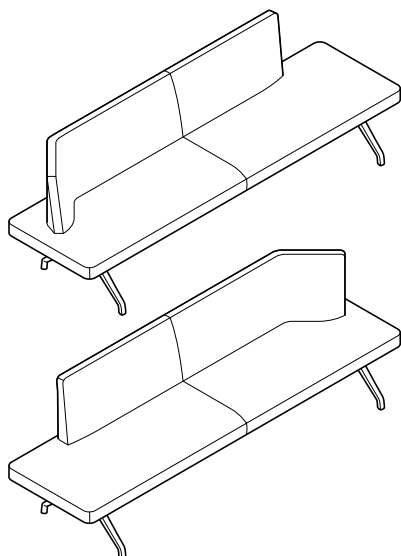
Polished aluminum foot section
High-luster polished aluminum foot section

Inline connector see accessories page 301

	60	64	65	66	68	91	92	74
	51	64	65	66	68	91	92	74
	54							
	58							
SEK	SEK	SEK	SEK	SEK	SEK	SEK	SEK	SEK
	36257	39995	45171	52763				
	819	819	819	819				
	1260	1260	1260	1260				
	•	•	•	•				

Upholstered bench with backrest

84 240 64
45



783/52

240 cm wide
3-seater
backrest slopes to the right with open end on the left or
backrest slopes to the left with open end on the right
Coated aluminum foot section

Additional charge/reduced prices

Polished aluminum foot section
High-luster polished aluminum foot section

Inline connector see accessories page 301

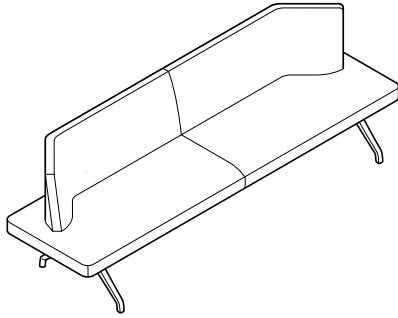
	60	64	65	66	68	91	92	74
	51	64	65	66	68	91	92	74
	54							
	58							
SEK	SEK	SEK	SEK	SEK	SEK	SEK	SEK	SEK
	37034	40961	46421	55041				
	819	819	819	819				
	1260	1260	1260	1260				
	•	•	•	•				

• available



Upholstered bench with backrest

84 240 64
45



783/55

240 cm breit
3-seater
backrest slopes to the right and left
Coated aluminum foot section

Additional charge/reduced prices

Polished aluminum foot section
High-luster polished aluminum foot section

Inline connector see accessories page 301

51
54
58

60
64
65
66
68

91
92

74

SEK SEK SEK SEK

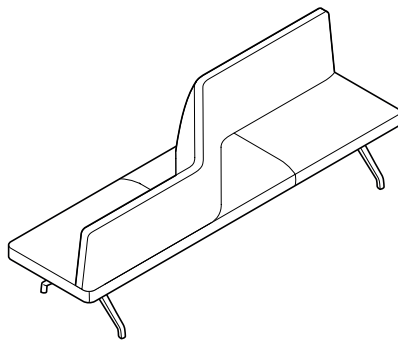
37401 41654 47565 56060

819 819 819 819
1260 1260 1260 1260

• • • •

Upholstered bench with backrest

84 240 64
45



783/56

240 cm wide
2 x 1.5-seater
Backrest that changes direction
Coated aluminum foot section

Additional charge/reduced prices

Polished aluminum foot section
High-luster polished aluminum foot section

Inline connector see accessories page 301

51
54
58

60
64
65
66
68

91
92

74

SEK SEK SEK SEK

40656 45098 51282 60974

819 819 819 819
1260 1260 1260 1260

• • • •

• available



60° upholstered bench with backrest

84 236 64
45

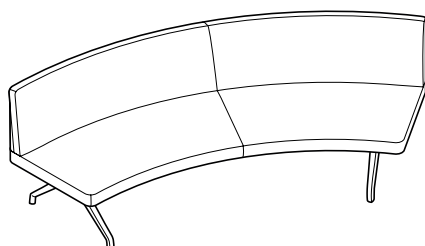
783/60

236 cm wide
3-seater
60° sloping backrest
Coated aluminum foot section

Additional charge/reduced prices

Polished aluminum foot section
High-luster polished aluminum foot section

Inline connector see accessories page 301



		60		
	51	64		
	54	65	91	
	58	66	92	74
		68		

SEK	SEK	SEK	SEK
55325	61215	69405	87686
819	819	819	819
1260	1260	1260	1260
•	•	•	•

Corner element

84/115 229 229
45

782/90

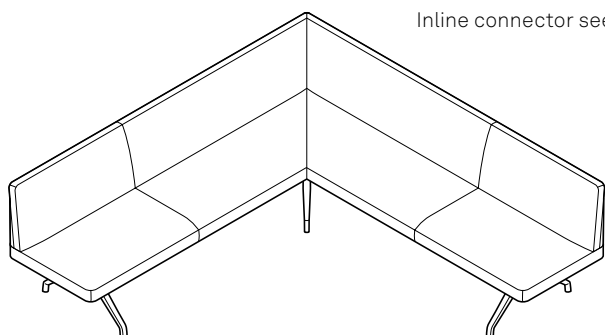
229 cm wide
2.5 x 2.5-seater
Backrest at a 90° angle
Coated aluminum foot section

Additional charge/reduced prices

High backrest

Polished aluminum foot section
High-luster polished aluminum foot section

Inline connector see accessories page 301



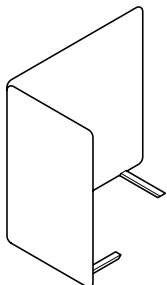
		60		
	51	64		
	54	65	91	
	58	66	92	74
		68		

SEK	SEK	SEK	SEK
71043	78929	89796	104391
11876	13839	16559	25232
1229	1229	1229	1229
1890	1890	1890	1890
•	•	•	•

• available



L-shaped screen on the right



781/11

Side- and rear-panel combination, 2-sided fully upholstered, with acoustic fleece, to fit to the upholstered bench with backrest
Side panel 64 cm wide

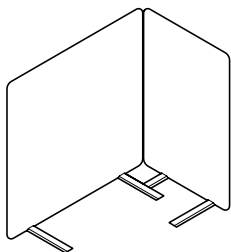
further rear panels, mod. 781/1 can be added

Width for models

Width	for models
101,5	782/51
120	783/55
165	782/5
229	782/90

		60	64	65	66	68	91	
	37		51	54	600		92	
	SEK		SEK		SEK		SEK	
	13986		15267		16874		19541	
	14784		16202		17987		20916	
	16653		18407		20633		24224	
	18039		20318		23174		27846	

L-shaped screen on the left



781/12

Side- and rear-panel combination, 2-sided fully upholstered, with acoustic fleece, to fit to the upholstered bench with backrest
Side panel 64 cm wide

Width for models

Width	for models
101,5	782/51
120	783/5
165	782/5
229	782/90

		60	64	65	66	68	91	
	37		51	54	600		92	
	SEK		SEK		SEK		SEK	
	13986		15267		16874		19541	
	14784		16202		17987		20916	
	16653		18407		20633		24224	
	18039		20318		23174		27846	



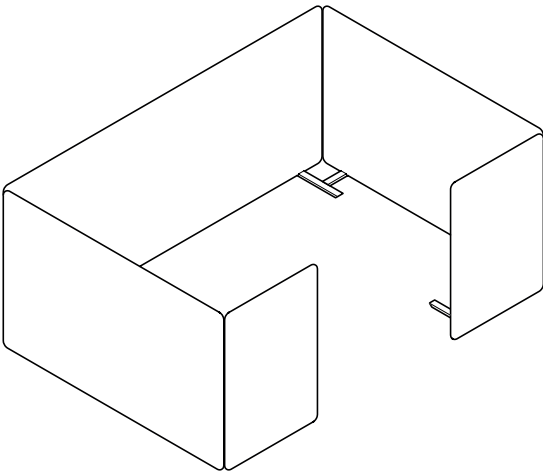
			60 64 65 66 68 600	91 92	
	37	51 54			
	SEK	SEK	SEK	SEK	
	45938	51198	57845	68733	
	56228	62076	69489	81648	
	59420	65814	73941	87192	

C-shaped screen

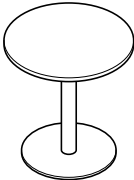
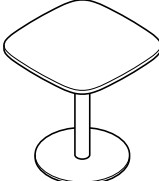
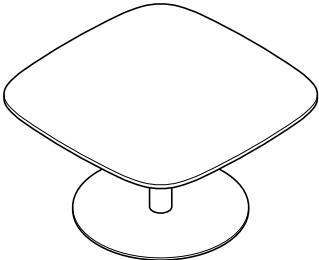
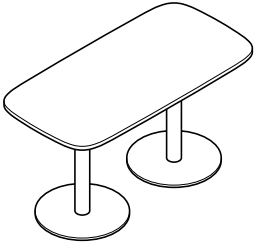
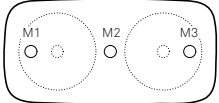
781/20

Side- and rear-panel combination, 5-sided fully upholstered, with acoustic fleece, to fit to the two upholstered benches with backrests
Side panels 64 cm wide

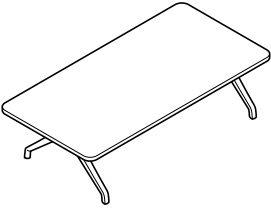
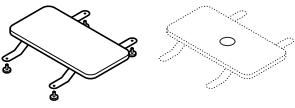
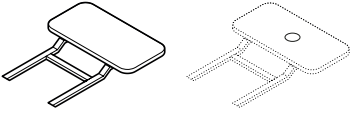
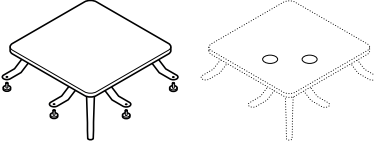
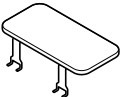
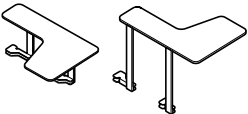
Width	for models
165	782/5
203	782/51
240	783/5





		1	1	7	7	2	2
		Laminate variant 1	Laminate variant 2	Black through-dyed	White through-dyed	Veneer variant 1	Veneer variant 2
		SEK	SEK	SEK	SEK	SEK	SEK
Round 	780/1 Ø 70 Disc base with coated cover and column	10668	11624	10280	11435	12422	12842
	Additional charge/reduced prices Disc base with stainless steel brushed cover and column Disc base with bright chrome-plated cover and column	1985 1985	1985 1985	1985 1985	1985 1985	1985 1985	1985 1985
	Chamfered lipping (in combination with veneer)					462	809
Square 	780/2 70 x 70 Rounded sides Disc base with coated cover and column	10668	11624	10280	11435	12422	12842
	Additional charge/reduced prices Disc base with stainless steel brushed cover and column Disc base with bright chrome-plated cover and column	1985 1985	1985 1985	1985 1985	1985 1985	1985 1985	1985 1985
	Chamfered lipping (in combination with veneer)					525	935
Square 	780/3 140 x 140 Rounded sides Disc base with coated cover and column	26681		25568	28938	29673	30923
	Additional charge/reduced prices Disc base with stainless steel brushed cover and column Disc base with bright chrome-plated cover and column	5240 5240		5240 5240	5240 5240	5240 5240	5240 5240
	Chamfered lipping (in combination with veneer)					2142	3014
Rectangular  	780/4 Rounded sides Disc base with coated cover and coated column 70x140 70x175	17661 19236	19541 21252	19142 19331	20654 21263	20832 22260	22607 23888
	Additional charge/reduced prices Disc base with stainless steel brushed cover and column Disc base with bright chrome-plated cover and column	3980 3980	3980 3980	3980 3980	3980 3980	3980 3980	3980 3980
	Chamfered edging for a 70 x 140 table (in combination with veneer)					1848	2195
	Chamfered edging for a 75 x 175 table (in combination with veneer)					2153	2541
	Cable management item M2	452	452	452	452	452	452
	Cable management item M1 and M3	756	756	756	756	756	756




		1	1	7	7	2	2
		Laminate variant 1	Laminate variant 2	Black through-dyed	White through-dyed	Veneer variant 1	Veneer variant 2
		SEK	SEK	SEK	SEK	SEK	SEK
Rectangular	780/9 Lounge table 70 x 140, H 38 Coated aluminum foot section	13262	15173	14543	16055	16454	18239
	Additional charge/reduced prices Polished aluminum foot section High-luster polished aluminum foot section	819 1260	819 1260	819 1260	819 1260	819 1260	819 1260
	Chamfered lipping (in combination with veneer)					1565	2195
Connecting table	780/10 for linear connection of two benches with integrated inline connectors Shelf space 64 x 32 cm Shelf space 64 x 64 cm	5376 7077	5796 7886	3917 4956	4326 5649	6248 8022	6647 8841
	Additional charge/reduced prices Chamfered lipping for 64 x 32 cm connecting table (when made of veneer) Chamfered lipping for 64 x 64 cm connecting table (when made of veneer)					284 567	336 662
Side table	780/11 can be fitted on the right or left Shelf space 64 x 32 cm	5492	5912	4032	4442	6353	6762
	Additional charge/reduced prices Chamfered lipping (in combination with veneer)					1040	1187
Corner table	780/12 for 90° linkage of two benches with integrated bench connectors shelf space 64 x 64 cm Coated aluminum foot section	8988	9755	6857	7550	10311	11109
	Additional charge/reduced prices Polished aluminum foot section High-luster polished aluminum foot section	410 630	410 630	410 630	410 630	410 630	410 630
	Chamfered lipping (in combination with veneer)					1124	1323
Shelf	780/13 for an open end on the right or left can be slotted between the side panel and seat Shelf space 64 x 32 cm (only in conjunction with a side panel and open end)	4379	4799	2919	3329	5240	5649
							
Corner writing ledge	780/14 for a side panel on the right or left can be fitted between the side panel and seat Corner writing ledge 60 x 40/20 cm, H 74 cm (only in conjunction with a side panel and open end)	6846	7266	5387	5796	7707	8117
							








SEK

Inline connector	780 Set for linear or back-to-back linkage of two benches with no side-/rear panel (one set is required for each bench connected)	1029
-------------------------	---------------------------------------------------------------------------------------------------------------------------------------------	------

Inline connector set	781 Set for linear of two benches, each with a rear panel (one set is required for each bench connected) Not compatible with a side panel	1029
-----------------------------	-----------------------------------------------------------------------------------------------------------------------------------------------------	------

Techni-station Frame 	701/94 To fit underneath the seat, sheet steel, black coated frame socket strip with 3 modules: 2 x power supply modules (please state the local standard when ordering) 1 x port with USB charger type A + type C with Smart IC and PD 2.0 to charge up to two mobile devices with connection for the supply lead, mod. 708/8	2993
-----------------------------------------------------------------------------------------------------------------	------------------------------------------------------------------------------------------------------------------------------------------------------------------------------------------------------------------------------------------------------------------------------------------------------------------------------------------------	------

Integrated techni-station Compact  	701/95 Set integrated techni-station Compact 701/95	
	with matt chrome cable outlet port, with a brushed profile	567
	1 x slot with wireless charging module (5 watt, Qi compliant) with supply lead approx. 180 cm and power supply unit	2762
	1 x power supply module (when ordering please state the local standard) with 40 cm supply lead, mod. 708/8 2 x slots with cover for optional Keystone modules	1145
	1 x power supply module (when ordering please state the local standard) with 40 cm supply lead, mod. 708/8 1 x USB port with Smart IC (charging current 2A max.) 1 x slot with cover for optional Keystone modules	1785
	Additional charge/reduced prices	
	Keystone module RJ 45 connector (category 6) as a thru-type coupling, without cables	147
	Keystone module, HDMI jack as a thru-type coupling, without cables	284
	Cable harness covered with black textile sleeving	1376



Supply lead



708/8

Length approx. 200 cm
Length approx. 300 cm
Length approx. 500 cm

221
263
357

Monitor mount



782

for side panel
with a multipurpose VESA mount and vertical cable management
for up to 40" screens

VESA mounting pattern (W x H mm):
200 x 200
200 x 100
100 x 100
75 x 75

2216



860 Range Asienta

jehs + laub



Technical details

Function

Upholstered chairs, upholstered benches with backrests, benches without backrests as well as matching tables for use in informal meeting and waiting areas, such as prestigious foyers, in executive offices, exclusive clubs or in homes. Upholstered chairs, upholstered benches with backrests and benches without backrests

Frame

Die-cast aluminum legs, optionally coated black or white, bright chrome-plated or with a chrome matte-polished finish. Underframe made of aluminum extruded profile like the legs. Black, multipurpose glides made of plastic for all types of flooring.

Seat and backrest

Leaf-sprung seat made of multiplex and solid wood (beech / birch). Back and side sections made of multiplex birch with a flexible top edge due to wide foam inserts that are covered with an elastic fabric. The cushioning is made of cut foam with extra padding. Tables

Frame

Die-cast aluminum table legs, optionally coated black or white, bright chrome-plated or with a chrome matte-polished finish. Underframe made of aluminum extruded profile like the legs.

Table tops

MDF panel (medium density fiberboard), 25 mm or ESG-Glas (single-pane reinforced glass), 10 mm. Panels are each placed flush with the underframe.

Table top group 2 – veneer

Table top thickness 25 mm Variant 1: beech, oak and ash veneer from the Wilkhahn woodstain color samples with wood lipping, color-matched as far as possible with the veneer. Variant 2: Maple, walnut or elm veneer from the Wilkhahn woodstain color samples with wood lipping color-matched as far as possible with the veneer. Closed-pore: maple and beech veneer. Some specific growth features possible.

Table top group 11 – glass

Table top thickness 10 mm ESG-Glas (single-pane reinforced glass) optionally varnished white or black opaque, edges/lipping polished.

Standards

The Asienta upholstered chair, upholstered benches with backrests and benches without backrests comply with the DIN EN 16139-L1 and ANSI/BIFMA X5.4 standards.



www.tuv.com
ID 1000000000

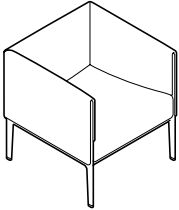
Upholstered chair, benches, tables

Base frame

- 49 Coated white (RAL9003)
- 51 Bright chrome-plated
- 53 Coated black (RAL9011)
- 76 Matte-polished chrome
- 90 Coated with a black textured matte finish (RAL9011)



Upholstered chair
 □72 □70 □69
 □44

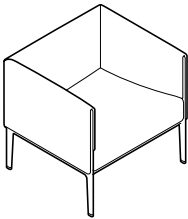


861/5
 Width 70 cm
 Coated frame

Additional charge/reduced prices
 Bright chrome-plated frame
 Matte-polished chrome frame

	60	91	74	87
	64	92		
	65			
	66			
	SEK	SEK	SEK	SEK
	19194	22754	25704	33306
	2289	2289	2289	2289
	4032	4032	4032	4032

Upholstered chair
 □72 □78 □69
 □44

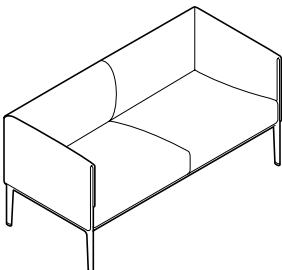


861/6
 Width 78 cm
 Coated frame

Additional charge/reduced prices
 Bright chrome-plated frame
 Matte-polished chrome frame

	60	91	74	87
	64	92		
	65			
	66			
	SEK	SEK	SEK	SEK
	20591	24266	28308	36887
	2352	2352	2352	2352
	4158	4158	4158	4158

Upholstered bench with backrest
 □72 □150 □69
 □44



862/5
 2-seater
 Coated frame

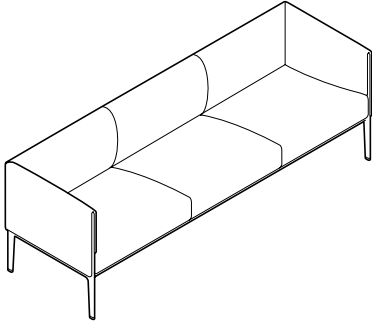
Additional charge/reduced prices
 Bright chrome-plated frame
 Matte-polished chrome frame

	60	91	74	87
	64	92		
	65			
	66			
	SEK	SEK	SEK	SEK
	27878	32771	37118	49382
	3644	3644	3644	3644
	6122	6122	6122	6122



Upholstered bench with backrest

72 218 69
 44



863/5

3-seater
 Coated frame

Additional charge/reduced prices

Bright chrome-plated frame
 Matte-polished chrome frame

60
 64
 65
 66

91
 92

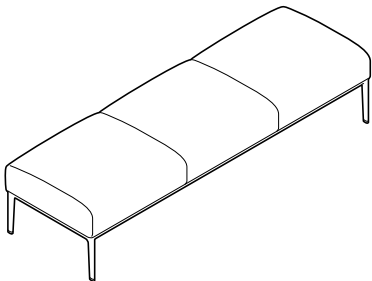
74

87

SEK	SEK	SEK	SEK
39050	45381	50201	66959
4200	4200	4200	4200
6983	6983	6983	6983

Bench without backrest

44 215 69



865/3

3-seater
 Coated frame

Additional charge/reduced prices

Bright chrome-plated frame
 Matte-polished chrome frame

60
 64
 65
 66

91
 92

74

87

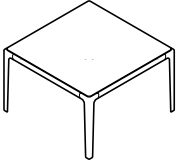
SEK	SEK	SEK	SEK
20024	22722	26177	39249
4011	4011	4011	4011
6615	6615	6615	6615



Veneer variant 1 **2**
Veneer variant 2 **2**
Glass **11**

SEK SEK SEK

Square

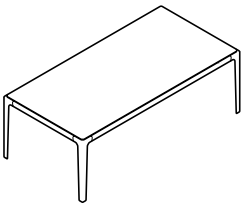


860/1
65 x 65, H 40
Coated frame

Additional charge/reduced prices
Bright chrome-plated frame
Matte-polished chrome frame

19121 19845 16727
2961 2961 2961
5135 5135 5135

Rectangular



860/2
120 x 60, H 40
Coated frame

Additional charge/reduced prices
Bright chrome-plated frame
Matte-polished chrome frame

20706 21357 19908
3644 3644 3644
6237 6237 6237



The usage concept, aesthetic, innovative functionality and first-class materials determine the quality and the return on investment of conference furniture. Another important aspect is how multimedia equipment is integrated in the tables.

Whether static table configurations, variable table systems, or mobile and dynamic solutions are required – the superb aesthetic and functional quality of the table ranges should also offer options for adding

state-of-the-art multi-media equipment. Depending on the requirements, Wilkhahn table ranges can integrate anything that's required to use today's multi-media equipment with ease – from cable outlets to different types of techni-stations for plug and play solutions. As a result, customized solutions are produced where most of the technology is cleverly concealed and part of the table system.





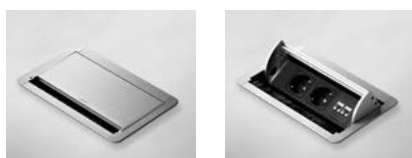
Techni-stations, cable lids and cable outlets

When it comes to integrating the outlets into the table top there are several solutions: Compact, fitted modules that are space-saving to integrate and can be customized with different ports. Pop-up or fold-out techni-stations with plug-and-play outlets are easy to handle, cables and adapters also stay on the table top in this case too. The high-quality cable lids coordinate especially well with the table.

Even when equipment is connected, only a small strip is visible. The outlets are underneath the table, so that residual cable and chargers can be accommodated in the horizontal cable management sets. Flexible techni-stations can be attached to the table edge without requiring any tools.

If cables are to be inserted through the table top, outlets are available that range from simple plastic to high-quality aluminum solutions.

Integrated techni-station basic



Clear anodized, aluminum body, plastic side sections similar to RAL 9006, black plastic modules. With integrated rubber profile or optionally with integrated brushed profile for cable outlet when closed. Frame surface mounted with hinge mechanism. Pre-wired, including cable. On request, with mechanism that opens by pressing the top. On request, cable harness covered with a black textile sleeving. Optionally with the following ports:

701/00 **3 modules:**
 2 x power supply modules (please state the local standard when ordering) with supply lead approx. 300 cm long
 1 x data module with 2 x RJ45 jacks (category 6 shielded) with permanently attached patch cables approx. 350 cm long or optionally with USB charger type A + type C with Smart IC and PD 2.0 to recharge up to two mobile devices.

701/10 **4 modules:**
 2 x power supply modules (please state the local standard when ordering) with supply lead approx. 300 cm long
 1 x data module with 2 x RJ45 jacks (category 6 shielded) with permanently attached patch cables approx. 350 cm long
 1 x module with VGA jack (15 pin D-sub) + 3.5 mm stereo jack or optionally HDMI jack with permanently attached cables, approx. 300 cm long

Integrated techni-station rotate



Clear anodized, aluminum body, plastic side sections similar to RAL 9006, black plastic modules. Frame flush-fitted with rotate to expose mechanism. Pre-wired, including cable. On request, with mechanism that opens at the touch of a button. On request, cable harness covered with a black textile sleeving. Optionally with the following ports:

701/60 **3 modules:**
 2 x power supply modules (please state the local standard when ordering) with supply lead approx. 300 cm long
 1 x data module with 2 x RJ45 jacks (category 6 shielded) with permanently attached patch cables approx. 350 cm long or optionally with USB charger type A + type C with Smart IC and PD 2.0 to recharge up to two mobile devices.

701/70 **4 modules:**
 2 x power supply modules (please state the local standard when ordering) with supply lead approx. 300 cm long
 1 x data module with 2 x RJ45 jacks (category 6 shielded) with permanently attached patch cables approx. 350 cm long
 1 x module with VGA jack (15 pin D-sub) + 3.5 mm stereo jack or optionally HDMI jack with permanently attached cables, approx. 300 cm long



Integrated techni-station square








Varnished aluminum body, plastic side sections, optionally in silver or black, black, plastic modules. Fitted frame. On request, cable harness covered with a black textile sleeving. Optionally with the following ports:

- 701/61** **3 modules:**
 2 x power supply modules (when ordering please state the local standard) with 40 cm supply lead, mod. 708/8
 1 x data module with 2 x RJ 45 jacks as thru-type coupling, each with 300 cm patch cables (category 6, shielded) or optionally with
 1 x slot with USB charger type A + type C with Smart IC and PD 2.0 to charge up to two mobile devices at their optimal rates (max. charging current 3A) as quickly as possible.
- 701/71** **4 modules:**
 2 x power supply modules (when ordering please state the local standard) with 40 cm supply lead, mod. 708/8
 1 x data module with 2 x RJ 45 jacks as thru-type coupling, each with 300 cm patch cables (category 6, shielded)
 1 x HDMI jack as thru-type coupling, with 300 cm cables (high speed + Ethernet).

Integrated techni-station compact



701/95
 Die-cast zinc installation frame, matte chrome. Frame attached, optionally round or square to fit different modules. The various modules are slotted into the installation frame without any tools. On request, cable harness covered with a black textile sleeving. Optionally with the following ports:

-  **Cable outlet square for installation frame**
 Matte chrome cable outlet with brushed profile
-  **Wireless charging module**
 1 x slot with a wireless charging module (5 watt, Qi compliant) for wireless charging of suitable mobile devices with an approx. 180 cm supply lead and power supply unit
-  **Power supply module**
 1 x power supply module (when ordering please state the local standard) with 40 cm supply lead, mod. 708/8
 2 x slots with cover for optional Keystone modules
-  **Power supply module and USB port**
 1 x power supply module (when ordering please state the local standard) with 40 cm supply lead, mod. 708/8
 1 x USB port with Smart IC to charge mobile devices at their optimal rates (max. charging current 2A) as quickly as possible
 1 x slot with cover for optional Keystone modules
-  **Optional**
 Keystone modules as thru-type coupling, exchangeable, without leads:
 RJ 45 jack (category 6) or HDMI jack



Integrated techni-station compact duo



701/96

Die-cast zinc installation frame, matte chrome. Fitted installation frame, rectangular frame to fit two exchangeable ports. The various modules are slotted into the installation frame without any tools. On request, cable harness covered with a black textile sleeving. Optionally with the following ports:



Cable outlet

Matte chrome cable outlet with brushed profile



Wireless charging module

1 x slot with a wireless charging module (5 watt, Qi compliant) for wireless charging of suitable mobile devices with an approx. 180 cm supply lead and power supply unit



Power supply module

1 x power supply module (when ordering please state the local standard) with 40 cm supply lead, mod. 708/8
2 x slots with cover for optional Keystone modules



Power supply module and USB port

1 x power supply module (when ordering please state the local standard) with 40 cm supply lead, mod. 708/8
1 x USB port with Smart IC to charge mobile devices at their optimal rates (max. charging current 2A) as quickly as possible
1 x slot with cover for optional Keystone modules



Optional

Keystone modules as thru-type coupling, exchangeable, without leads:
RJ 45 jack (category 6) or HDMI jack

Techni-station Compact Add



701/97

Flexible techni-station for tool-free assembly on the table edge using a knurled screw. Can be used on straight and bullnose lipping (for table top thicknesses from 12 - 30 mm). Robust metal housing, coated similar to RAL 9006, black plastic modules, pre-wired and including cable. On request, cable harness covered with a black textile sleeving. Optionally with the following ports:



Power supply module

1 x power supply module (when ordering state the local standard) with supply lead approx. 270 cm long
2 x slots with cover for optional Keystone modules



Optional

Keystone modules:
RJ 45 jack (category 6) with permanently attached cable, approx. length 330 cm or
HDMI jack with permanently attached cable, approx. 270 cm in length



Cable outlets



707/1 Cable outlet
Black plastic, Ø 80 mm

Cable lid Executive



Cable lid with brushed profile the same color and material as the table top on both sides. Cut out section with real wood lipping all the way round, color-matched as far as possible with the table top.
Cable lid 300 x 150 mm, (inside dimensions 300 x 150 mm) flush-fitted, hinges open at 180°.

In conjunction with the socket strips there are lots of connection options.

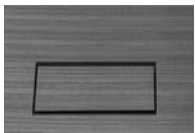
Cable lid Basic



Aluminum installation frame with cable lid and brushed profile
Frame attached, cable lid 300 x 120 mm, (inside dimensions 270 x 90 mm) opens at 90°.

In conjunction with the socket strips there are lots of connection options.

Cable lid Graph



300/01 **Cable lid opening lengthwise**
beveled on both of the long sides (can be used on both sides), gas-lift damped, automatic opening mechanism, Cable lid color and material the same on both sides.
Cable lid: 300 x 165 mm (Inside length of Graph cable lid: 300 x 120 mm)



300/02 **Cable lid opens sideways**
beveled on one of the long sides (can be used from one side), gas-lift damped, automatic opening mechanism, Cable lid color and material the same on both sides.
Cable lid: 300 x 165 mm (Inside width of Graph cable lid: 300 x 138 mm)



Socket strips



Socket strip made of sturdy, black plastic, to fit underneath the cable lid executive and basic. Depending on the table range and mounting position, can be fitted to a mount, in a cable channel or underframe. The appropriate assembly materials are included in the sets.

Body at the side with 230 V input and output (plug + GST18/3 jack) to connect supply and extension leads, mod. 708/8 and 708/9.

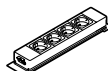
Optionally with the following ports:



708/1 Socket strip
3 modules:
3 x power supply modules (please state the local standard when ordering)



708/2 Socket strip
3 modules:
2 x power supply modules (when ordering please state the local standard).
1 x data module with 2 x RJ45 jack (category 6, shielded)
with permanently attached patch cables approx. 350 cm long
or optionally with USB charger type A + type C with Smart IC and PD 2.0 to recharge up to two mobile devices.

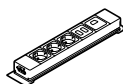


708/4 Socket strip
4 modules:
4 x power supply modules (please state the local standard when ordering).



708/5 Socket strip
4 modules:
2 x power supply modules (when ordering please state the local standard).
1 x data module with 2 x RJ45 jack (category 6, shielded)
with permanently attached patch cables approx. 350 cm long

1 x module for a VGA connector (D-sub 15 pin) + stereo jack 3.5 mm, or optionally HDMI jack with permanently attached cables approx. 300 cm long



708/6 Socket strip
5 modules:
3 x power supply modules (when ordering please state the local standard).
1 x data module with 2 x RJ45 jack (category 6, shielded)
1 x data module with 1 x RJ45 jack (category 6, shielded)
with permanently attached patch cables approx. 350 cm long



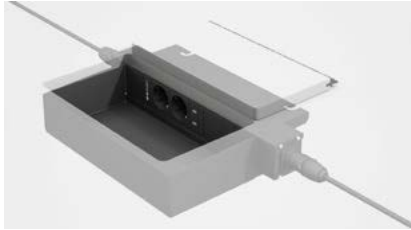
708/8 Supply lead
3 x 1.5 mm², black
Schuko right angle plug + GST18/3 jack
Length optionally approx. 200, 300 or 500 cm



708/9 Extension lead
3 x 1.5 mm², black
Plug + GST18/3 jack
Length optionally approx. 200 or 300 cm



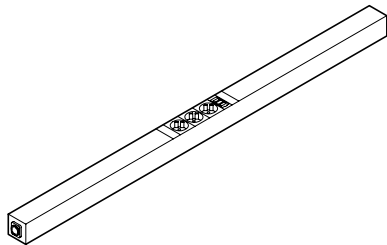
Power Bar



Linkable connection system for mobile table ranges.

Socket strip made of black or white coated aluminum, modules made of sturdy, black or white plastic, can be fitted underneath the Executive and Basic single table portal. Can be fitted to the cable channel or underframe, depending on the table range and mounting position. The appropriate assembly materials are included in the sets.

Body with inputs and outputs at the side for Neutrik-powerCON® cable, mod. 702/8 and 702/9. The connector system with locking action and strain relief means that connecting to the power supply is safer, easy and fast.



704/10

Body optionally in black or white
mit input/output for Neutrik-powerCON® cable
1 x power supply module (when ordering please state the local standard)
3 x configurable blank sections

704/10 3 x configurable blank sections

Power and charging fields must be configured directly after one another



Power supply module (when ordering, please state local standard)



Dual USB-A charging, 1/2 module



Dual USB-C and USB-A charging, 1/2 module



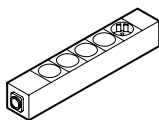
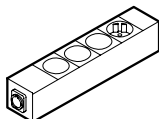
USB-C power charging 60W, module



Blanking plate, 1/2 module



Blanking plate, module



704/00

Body optionally in black or white
 mit input/output for Neutrik-powerCON® cable
 1 x power supply module (when ordering please state the local standard)
 3 x configurable blank sections

705/00

Body optionally in black or white
 mit input/output for Neutrik-powerCON® cable
 1 x power supply module (when ordering please state the local standard)
 4 x configurable blank sections

704/00 and 705/00 3 x configurable blank sections

Power and charging fields must be configured directly after one another



Power supply module (when ordering, please state local standard)



Dual USB-A charging, 1/2 module



Dual USB-C and USB-A charging, 1/2 module



USB-C power charging 60W, module



USB 3.0-data, Keystone module, 1/2 module



USB-C data (1/2 module) with approx. 30 cm cable



RJ45 network, CAT 6, Keystone module, 1/2 module



Twin network RJ45, CAT 6, Keystone module, module



HDMI, Keystone module, 1/2 module



Blanking plate, 1/2 module



Blanking plate, module



702/8

Supply lead
 Neutrik-powerCON®, black
 Schuko right angle plug + Neutrik-powerCON®
 Length optionally approx. 200, 300 or 500 cm



702/9

Extension lead
 Neutrik-powerCON®, black
 Neutrik-powerCON® IN + Neutrik-powerCON® OUT
 Length optionally approx. 80, 100, 150 or 300 cm

Optional

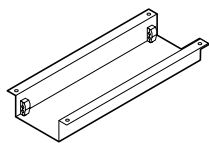
Patch cable CAT6, length approx. 200 cm
 Patch cable CAT6, length approx. 300 cm
 USB 3.0 data cable, length approx. 300 cm
 USB type C data, connecting cable, length approx. 300 cm
 HDMI cable, length approx. 300 cm



Cable management

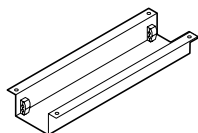
Options for cable management sets are just as varied. For horizontal management underneath the table, such cable management sets and retractable cable baskets or -channels are recommended that contain the technical components. Cables can be inserted vertically in the table legs, via external cable clips or textile sleeving.

Horizontal cable management sets



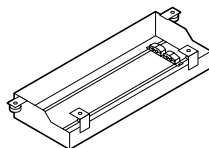
Cable cover for integrated techni-station basic, models 701/00 and 701/10

made of aluminum sheet, attached to the table top, coated black, with strain relief on both sides, length 550 mm



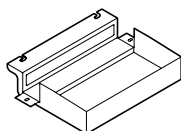
Cable cover for integrated techni-station rotate, models 701/60 and 701/70

made of aluminum sheet, attached to the table top, coated black, with strain relief on both sides, length 550 mm



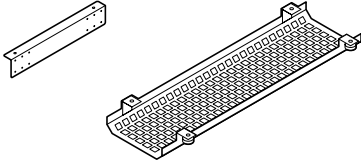
Cable channel for cable lid executive or basic, to integrated a socket strip models 708/1 to 708/6

made of aluminum extruded profile, retractable, coated black with strain relief and insertion plates to integrate the socket strip, length 540 mm

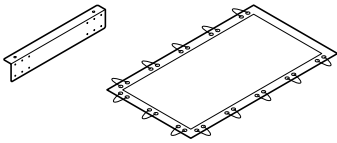


Cable channel for Executive or Basic cable lid, to attach a Power Bar socket strip mod. 702/00

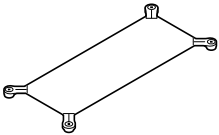
made of sheet steel, coated black, length 358 mm, with black sponge rubber lining, optionally with extra bumper made of sponge rubber on the bottom (for mod. 610)



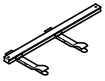
Cable basket for cable lid executive or basic, for socket strip models 708/1 to 708/6
curved, perforated metal basket, retractable, black coated, to fit underneath the table top, with mount for socket strip, metal brackets, coated black



Storage mesh for executive or basic cable lid for socket strip models 708/1 to 708/6
Black polyester to match the table length, with mount for socket strip, metal brackets, coated black



Storage mesh for 460 mAx/465 mAx light table range for integrated techni-station compact
Black polyester, length 430 mm



Cable holder underneath the table top with hook and loop fasteners
Anodized aluminum profile with 2 polypropylene cable clips attached; with hook and loop straps



Vertical cable management sets



Cable clip for the table leg

made of black, fiberglass-reinforced polyamide for cable management on the table frame's upright.



Textile sleeving for cable harness

belonging to the techni-stations or socket strips



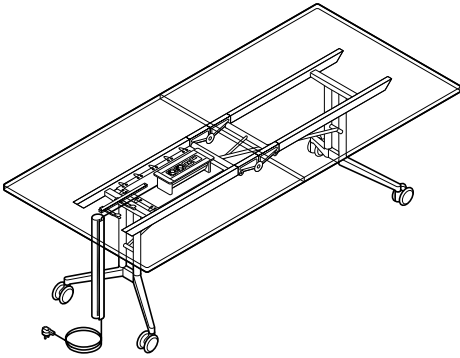
Vertical cable channel mod. 620/2

for cable management between the uprights in the Logon 620 range,
coated in black or a silver satin finish

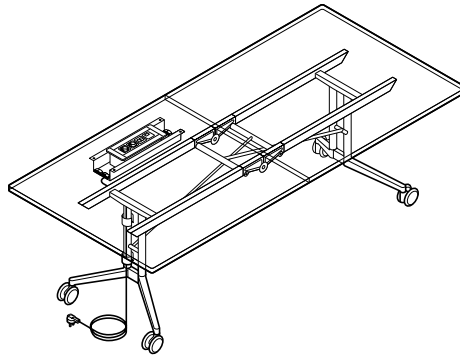


Beispieldarstellungen für die verbauten Integrierten Technikboxen und Einbauklappen und deren Kabelführung

Confair Falttisch

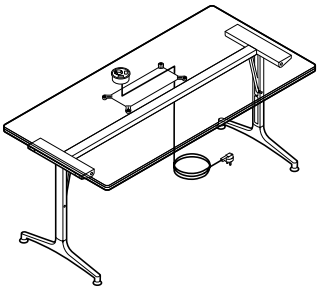


Integrierte Technikbox Beidseitig, Kabelzuführung mit Klettband, Kabelbaum mit Gewebeschlauch ummantelt



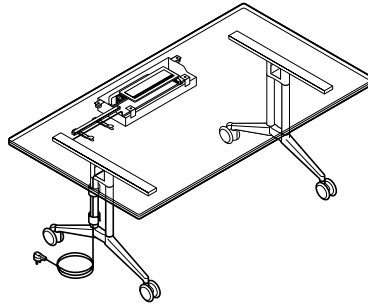
Set Integrierte Technikbox Beidseitig, mit Kabelabdeckung und Kabelklammern am Tischbein

mAx|mAx light



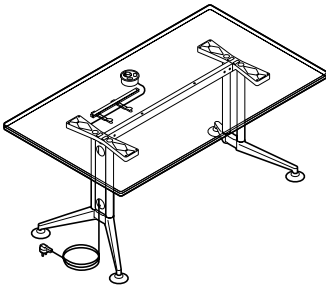
Set integrierte Technikbox Compact, mit Ablagenetz

Timetable Shift

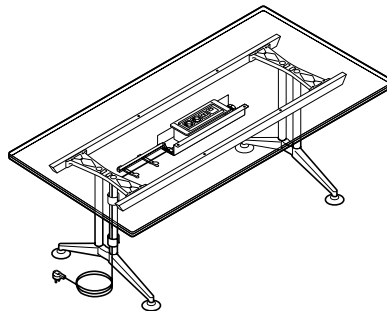


Set Einbauklappe, mit Kabelabdeckung Kabelzuführung mit Klettband, Kabelklammer am Tischbein

Logon



Set Integrierte Technikbox Compact, Kabelzuführung mit Klettband, vertikaler Kabelkanal



Set Integrierte Technikbox Beidseitig, mit Kabelabdeckung, Kabelzuführung mit Klettband und Kabelklammer am Tischbein



Edging matrix.

Wilkhahn has more than 135 different types of wood-based table tops to choose from, available as standard and customized versions.

The edging matrix indicates which edging types can or cannot be made for a particular table range in the different surface finishes and thicknesses, or require prior clarification.

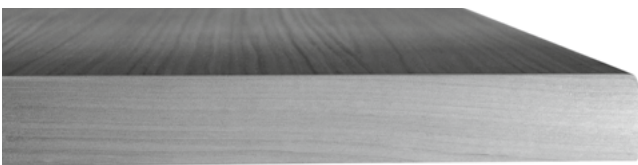
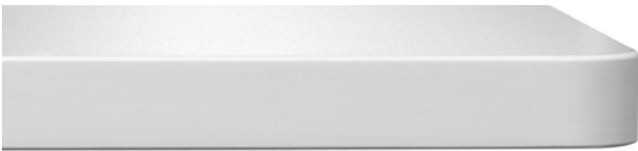
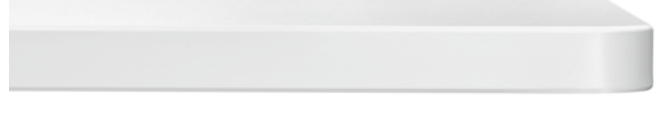
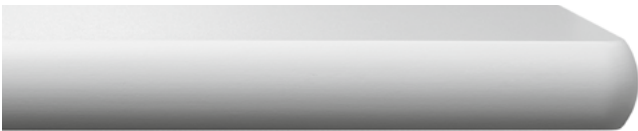
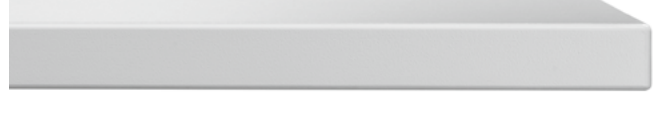
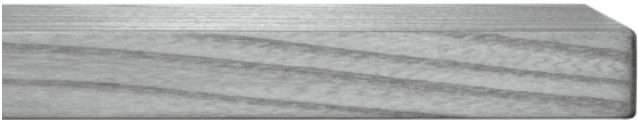
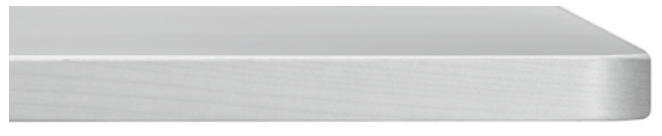
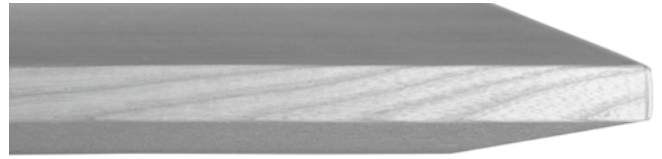
Concealed lipping is oversailing veneer. Visible lipping is pre-glued lipping.

Laminate

- Edge always with a natural oiled finish
- The edge is varnished in the same color as the table top, concealed lipping is only available as a customized solution

Veneer

- Table top and edging mostly stained and varnished in the same color



Wilkhahn®

Wilkening + Hahne GmbH+Co. KG
Fritz-Hahne-Straße 8
31848 Bad Münder
+ 49 (0) 5042 999-0
+ 49 (0) 5042 999-226
info@wilkhahn.de
www.wilkhahn.de

Australia
Wilkhahn Asia Pacific
Head Quarters
Wilkhahn Forum Sydney
74 Wentworth Avenue
Surry Hills NSW 2010
+ 61 2 9310 3355
info@wilkhahn.com.au
www.wilkhahn.com.au

Wilkhahn Forum Brisbane
Level 2, 17 Byres Street
Newstead QLD 4006
+ 61 7 3369 2088
info@wilkhahn.com.au
www.wilkhahn.com.au

Wilkhahn Forum Melbourne
477 Collins St
Melbourne VIC 3000
+ 61 3 9670 5570
info@wilkhahn.com.au
www.wilkhahn.com.au

Belgium
Wilkhahn
Havenlaan 86C
1000 Brussel
+ 32 3 232 93 91
+ 32 3 227 16 16
info@wilkhahn.be

China
Wilkhahn Asia Pacific
Room 301, Floor 3
83 Fu Min Rd | Shanghai Jing
An District
Shanghai 200000
+ 86 21 5466 1919
+ 86 21 5465 1642
info@wilkhahn.com.cn
www.wilkhahn.com.au

España
Wilkhahn S. A.
C/Fidias, 4 Bajo
28011 Madrid
+ 34 60 96 65 793
info@wilkhahn.es
www.wilkhahn.es

Great Britain
Wilkhahn Ltd.
Wilkhahn Forum London
45 Great Sutton Street
London EC1V 0DE
+44 (0) 207 324 2900
+44 (0) 207 324 2901
info@wilkhahn.co.uk

Hong Kong
Wilkhahn Asia Pacific
Wilkhahn Forum Hong Kong
Rooms 4505-7, 45/F
China Online Centre
No. 333 Lockhart Road
Wanchai
+ 852 2827 0800
+ 852 2827 0855
info@wilkhahn.com.hk
www.wilkhahn.com.hk

Japan
Wilkhahn Japan Co., Ltd.
Wilkhahn Forum Tokyo
Tokyotatemono Aoyama
Building B1 3-3-5
Kitaoyama, Minato-ku
107-0061 Tokyo
+ 81 (0) 3 5414 8088
+ 81 (0) 3 5414 8089
info@wilkhahn.co.jp
www.wilkhahn.co.jp

Maroc
Maroc Bureau
Autoroute de Rabat -
Km 9,200
Ain Sebaâ - Casablanca
20260
+212 5 22 35 37 55
+212 5 22 35 51 25
info@maroc-bureau.com

Nederland
Wilkhahn B.V.
Van Nelle Fabriek
Van Nelleweg 2120
3044 BC Rotterdam
+31 10 750 33 90
info@wilkhahn.nl

Österreich
Wilkhahn Handelsges.m.b.H.
Ankerbrot-Fabrik
Absberggasse 27, Stg. 7/7.11A
1100 Wien
+ 43 1 894 21 68-0
+ 43 1 890 32 39-15
info@wilkhahn.at

Schweiz
Wilkhahn AG
Postgasse 17
Postfach 808
3000 Bern 8
+ 41 31 310 13 13
+ 41 31 310 13 19
info@wilkhahn.ch
www.wilkhahn.ch

Singapore
Wilkhahn Asia Pacific
Wilkhahn Forum Singapore
20 Martin Road
#05-02 Seng Kee Building
Singapore 239070
+ 65 622 111 86
+ 65 622 111 25
info@wilkhahn.com.sg
www.wilkhahn.com.sg

South Africa
Classic Working Life
43 Houghton Drive,
Houghton Estate
2198 Johannesburg
+27 (0) 11 728 9542
info@classicwl.co.za
www.classicwl.co.za

United States of America
Wilkhahn Lab
Wilkhahn Inc.
10 Greene Street
New York, NY 10013
+ 1 212 229 9455
+ 1 212 229 4772
sales@wilkhahn.com
www.wilkhahn.com/en-us

Service



Contact us if you required more information.

With information about products, projects and service, the website's new structure and design provide easy and clear access to the Wilkhahn world. You'll be able to find everything you need there – from digital brochures to CAD data to reference images.

Why not read our blog to find out all the exciting things happening at Wilkhahn in the world of design, architecture and industry?

Our online product literature and digital brochures contain more in-depth information.

Wilkening + Hahne GmbH+Co.KG
Fritz-Hahne-Str. 8, 31848 Bad Münder, Germany
Tel.: +49 5042 999 100

contact@wilkhahn.de
www.wilkhahn.com

