

Northern

# Price list Lighting

2023

Valid 01.03.2023 — 31.08.2023  
NOK, SEK, DKK, EUR

## **Northern**

We combine beauty with functionality and prefer natural materials and genuine craftsmanship. Furniture, lighting and interior accessories are a natural fit for what we do, enabling us to express our characteristic style.

Inspired by the pale beauty and rough-cut contrasts of the North, the Oslo-based brand is Nordic in spirit, yet global in style.

[northern.no](http://northern.no)

# Content

## Lighting

<u>Acorn floor</u>	P. 6	<u>Gear floor</u>	P. 29
<u>Acorn pendant</u>	P. 7	<u>Gear table</u>	P. 30
<u>Balancer floor</u>	P. 8	<u>Glint wall</u>	P. 31
<u>Balancer wall</u>	P. 9	<u>Heat pendant</u>	P. 32
<u>Balancer mini wall/table*</u>	P. 10	<u>Ink wall</u>	P. 33
<u>Birdy floor</u>	P. 11	<u>Me dim floor</u>	P. 34
<u>Birdy floor swing</u>	P. 12	<u>Moo wall</u>	P. 35
<u>Birdy table</u>	P. 13	<u>Ombre table</u>	P. 36
<u>Birdy table swing</u>	P. 14	<u>Oslo Wood floor</u>	P. 37
<u>Birdy wall</u>	P. 15	<u>Over Me series</u>	P. 38
<u>Blush pendant</u>	P. 16	<u>Reveal pendant</u>	P. 39
<u>Blush rail 3 pendant</u>	P. 17	<u>Salto floor*</u>	P. 40
<u>Blush rail 5 pendant</u>	P. 18	<u>Salto table*</u>	P. 42
<u>Blush wall</u>	P. 19	<u>Say My Name series</u>	P. 43
<u>Buddy floor</u>	P. 20	<u>Snowball floor</u>	P. 44
<u>Buddy table</u>	P. 21	<u>Snowball table</u>	P. 45
<u>Buddy wall</u>	P. 22	<u>Tradition pendant*</u>	P. 46
<u>Butterfly wall</u>	P. 23	<u>Unika pendant</u>	P. 47
<u>Butterfly perforated</u>	P. 24		
<u>Circle pendant</u>	P. 25	<u>Spare parts</u>	P. 48
<u>Dahl pendant</u>	P. 26	<u>Terms &amp; Conditions</u>	P. 51
<u>Diva series</u>	P. 27		
<u>Dokka pendant</u>	P. 28	<b>New products *</b>	





# Description lighting

## Symbols

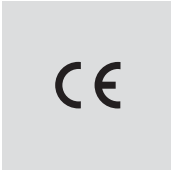

CE approval



Class 1

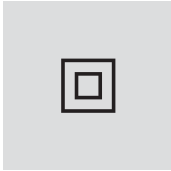

Class 2



IP20

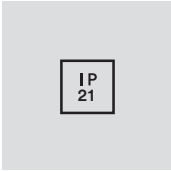

IP21

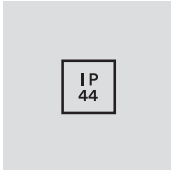

IP44



UK plug available

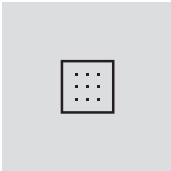

LED (Light source)

# Acorn floor

P. 6

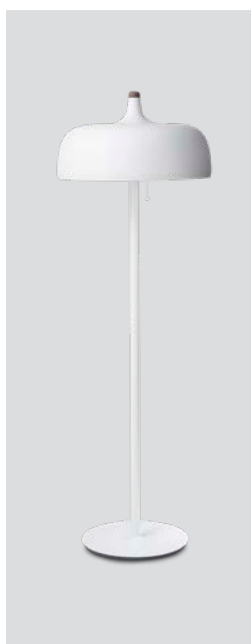

Acorn floor white matt  
– Item no. 549



Acorn floor grey matt  
– Item no. 550

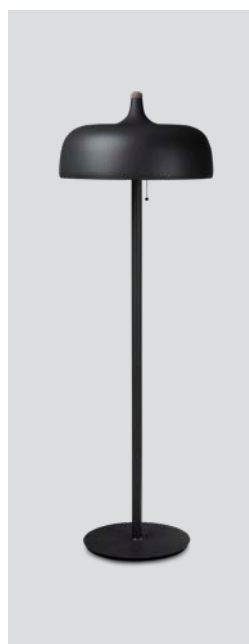

Acorn floor black matt  
– Item no. 551



Light beech top



Dark walnut top

**Product type:** Floor lamp  
**Design:** Atle Tveit, 2021  
**Shade material:** Aluminium  
**Shade and body colour:** White, grey or black  
**Shade inner colour:** White  
**Body material:** Steel  
**Wooden top part:** Light beech or dark walnut (both colours are included)  
**Wire:** White (white version), or black (grey and black versions), 200 cm  
**Switch:** Pull string switch (on/off)  
**Bulb:** E27, Max. 3 x 13 W LED only  
**Voltage:** 220V - 240V - 50/60Hz  
**Net weight:** 13.7 kg  
**Minimum order size:** 1  
**Spare parts available:** Wooden parts

## Dimensions and light direction:

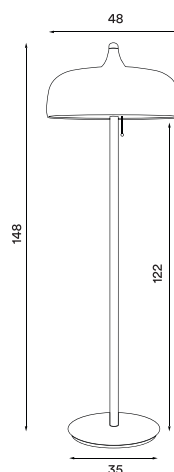

## Recommended bulbs:



Prices NOK (RRP ex. VAT) (RRP incl. VAT)

7 192,- 8 990,-

Prices SEK (RRP ex. VAT) (RRP incl. VAT)

7 992,- 9 990,-

Prices DKK (RRP ex. VAT) (RRP incl. VAT)

5 832,- 7 290,-

Prices Euro (RRP ex. VAT) (RRP incl. VAT)

833,- 999,-



# Acorn pendant

P. 7



Acorn pendant white matt  
– Item no. 543

Acorn pendant grey matt  
– Item no. 544

Acorn pendant black matt  
– Item no. 545

**Product type:** Pendant lamp

**Design:** Atle Tveit, 2012

**Shade material:** Aluminium

**Shade colour:** White, grey or black

**Shade inner colour:** White

**Wooden parts:** Light beech or dark walnut  
(both colours are included)

**Wire:** White (white version), grey (grey version) or black (black version), silk 370 cm

**Bulb:** E27, Max. 100 W

**Voltage:** 220V - 240V - 50Hz

**Net weight:** 2.3 kg

**Minimum order size:** 1

**Spare parts available:** Ceiling mounted canopy, wooden parts

## Dimensions and light direction:

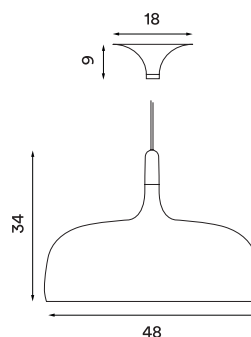

## Recommended bulb:



## Prices NOK

(RRP ex. VAT) (RRP incl. VAT)

3 192,-	3 990,-
---------	---------

## Prices SEK

(RRP ex. VAT) (RRP incl. VAT)

3 512,-	4 390,-
---------	---------

## Prices DKK

(RRP ex. VAT) (RRP incl. VAT)

2 632,-	3 290,-
---------	---------

## Prices Euro

(RRP ex. VAT) (RRP incl. VAT)

374,-	449,-
-------	-------





Balancer floor  
– Item no. 665

**Product type:** Floor lamp  
**Design:** Yuue, 2017  
**Base, body and shade material:** Steel  
**Base, body and shade colour:** Black matt  
**Light diffuser material:** Mouth blown glass  
**Light diffuser colour:** Opal white matt  
**Wire:** Black, 200 cm  
**Dimmer switch:** Black (on wire)  
**Bulb:** E27, Max. 60 W (dimnable)  
**Voltage:** 220V - 240V - 50Hz  
**Net weight:** 16.0 kg  
**Minimum order size:** 1  
**Spare parts available:** Light diffuser glass

**Dimensions and light direction:**

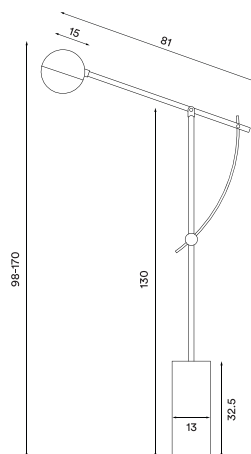

**Recommended dimmable bulb:**

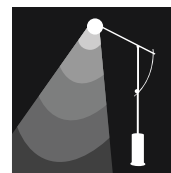

Prices NOK	(RRP ex. VAT)	(RRP incl. VAT)	Prices SEK	(RRP ex. VAT)	(RRP incl. VAT)
	7 992,-	9 990,-		8 792,-	10 990,-
Prices DKK	(RRP ex. VAT)	(RRP incl. VAT)	Prices Euro	(RRP ex. VAT)	(RRP incl. VAT)
	6 392,-	7 990,-		916,-	1 099,-

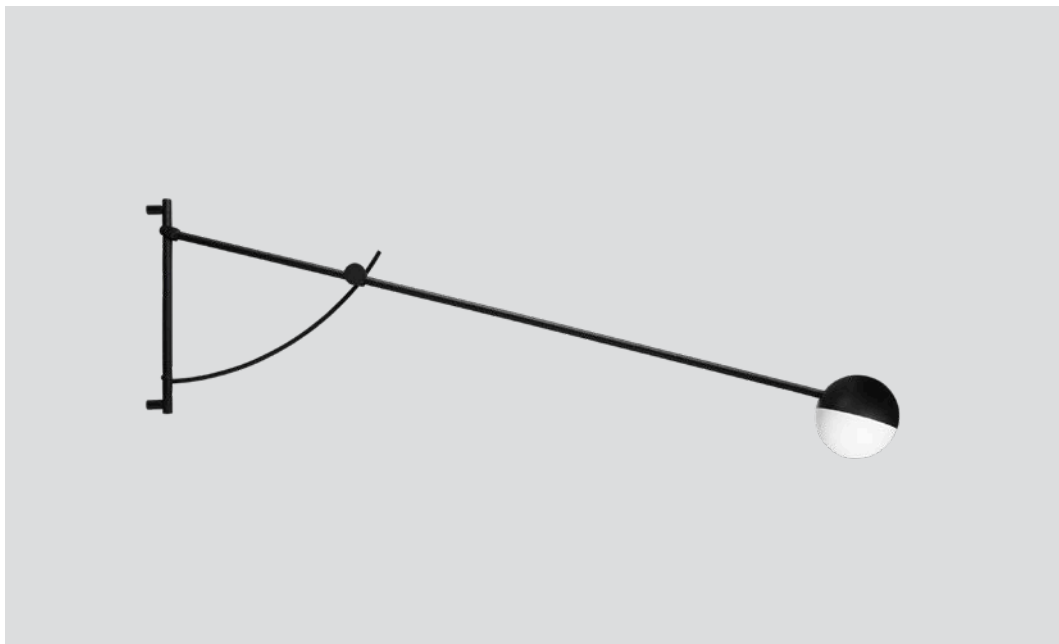

Balancer wall  
– Item no. 670

**Product type:** Wall lamp

**Design:** Yuue, 2020

**Base, body and shade material:** Steel

**Base, body and shade colour:** Black matt

**Light diffuser material:** Mouth blown glass

**Light diffuser colour:** Opal white matt

**Wire:** Black, 200-260 cm (without switch)

**Bulb:** E27, Max. 60 W

**Voltage:** 220V - 240V - 50/60Hz

**Net weight:** 2.7 kg

**Minimum order size:** 1

**Spare parts available:** Light diffuser glass

## Dimensions and light direction:

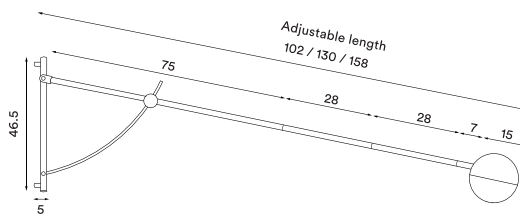

## Recommended bulb:

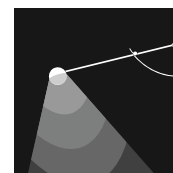

Prices NOK	(RRP ex. VAT)	(RRP incl. VAT)	Prices SEK	(RRP ex. VAT)	(RRP incl. VAT)
	6 392,-	7 990,-		7 192,-	8 990,-
Prices DKK	(RRP ex. VAT)	(RRP incl. VAT)	Prices Euro	(RRP ex. VAT)	(RRP incl. VAT)
	5 192,-	6 490,-		749,-	899,-

# Balancer mini wall/table

P. 10

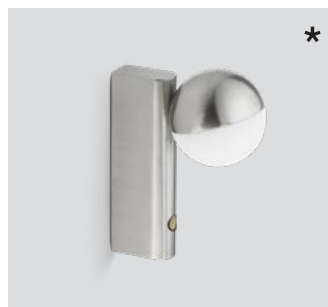
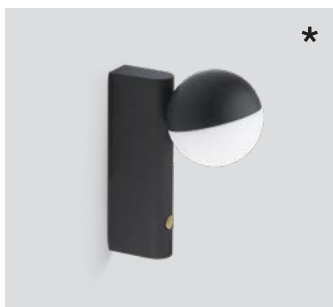

Balancer mini wall/table black  
– Item no. 700

Balancer mini wall/table cherry red  
– Item no. 702

Balancer mini wall/table steel  
– Item no. 704

**Product type:** Wall and table lamp

**Design:** Yuue, 2022

**Body and shade material:** Steel

**Body and shade colour:** Black, cherry red or steel

**Light diffuser material:** Mouth blown glass

**Light diffuser colour:** Opal white matt

**Wire:** Black, 200 cm

**Switch:** 3-step touch dimmer (on lamp)

**Bulb:** Integrated LED 6 W, 550 lm, 2700 K, CRI > 85, step dim

**Voltage:** 220V - 240V - 50/60Hz

**Net weight:** 1.0 kg

**Minimum order size:** 2

**Spare parts available:** Light diffuser glass

## Dimensions and light direction:

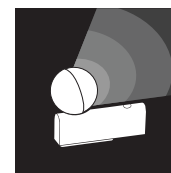
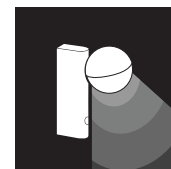
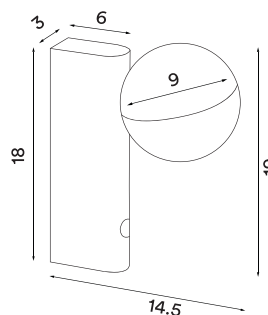

## Light source included:

LED 6 W - Energy class: G



## Prices NOK

(RRP ex. VAT) (RRP incl. VAT)

2 392,-	2 990,-
---------	---------

## Prices SEK

(RRP ex. VAT) (RRP incl. VAT)

2 632,-	3 290,-
---------	---------

## Prices DKK

(RRP ex. VAT) (RRP incl. VAT)

1 912,-	2 390,-
---------	---------

## Prices Euro

(RRP ex. VAT) (RRP incl. VAT)

266,-	319,-
-------	-------





# Birdy floor

P. 11



Birdy floor black / brass  
– Item no. 620



Birdy floor white / steel  
– Item no. 621



Birdy floor grey / steel  
– Item no. 622



Birdy floor black / black  
– Item no. 623



Birdy floor black / steel  
– Item no. 624

**Product type:** Floor lamp  
**Design:** Birger Dahl, 1952  
**Shade material:** Aluminium  
**Shade, base and handle colours:** White, grey or black (shade inner colour is same as outer colour)  
**Body material:** Steel  
**Body and joints colour:** Steel, brass or black  
**Wire:** Black (grey and black versions only) or white (white version only), 200 cm (with on/off switch)  
**Bulb:** E27, Max. 11 W LED only  
**Voltage:** 220V - 240V - 50/60Hz  
**Net weight:** 5.0 kg  
**Minimum order size:** 1

## Dimensions and light direction:

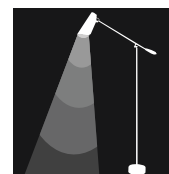
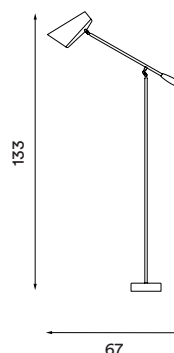

## Recommended bulb:



Prices NOK	(RRP ex. VAT)	(RRP incl. VAT)	Prices SEK	(RRP ex. VAT)	(RRP incl. VAT)
	3 992,-	4 990,-		4 392,-	5 490,-
Prices DKK	(RRP ex. VAT)	(RRP incl. VAT)	Prices Euro	(RRP ex. VAT)	(RRP incl. VAT)
	3 192,-	3 990,-		458,-	549,-



# Birdy floor swing

P. 12

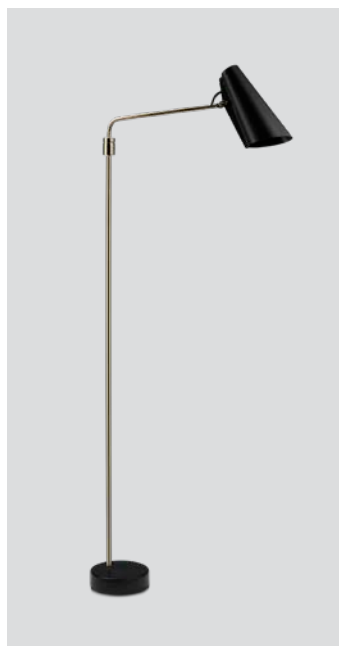

Birdy floor swing black / brass  
– Item no. 628

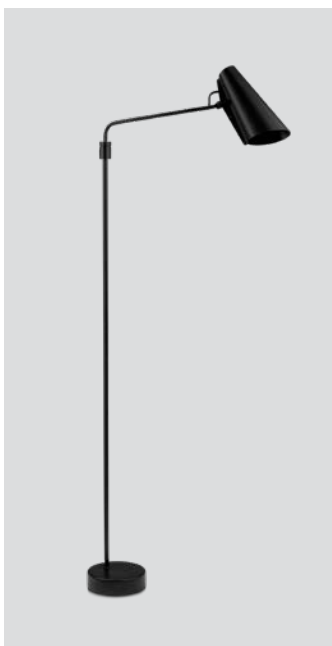

Birdy floor swing black / black  
– Item no. 629

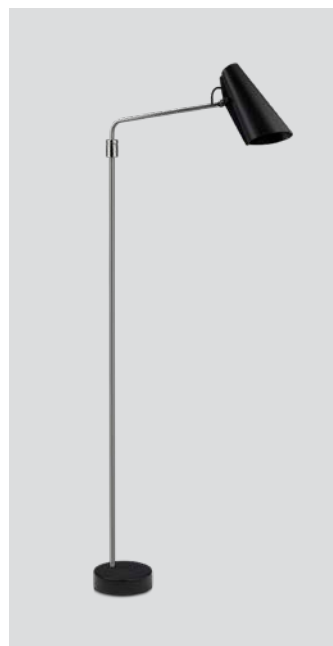

Birdy floor swing black / steel  
– Item no. 609

**Product type:** Floor lamp  
**Design:** Birger Dahl, 1952/2021  
**Shade material:** Aluminium  
**Shade and base colours:** Black (shade inner colour is same as outer colour)  
**Body material:** Steel  
**Body and joints colour:** Brass, black or steel  
**Wire:** Black, 200 cm  
**Switch:** On/off switch on the shade  
**Bulb:** E27, Max. 11 W LED only  
**Voltage:** 220V - 240V - 50/60Hz  
**Net weight:** 5.3 kg  
**Minimum order size:** 1

## Dimensions and light direction:

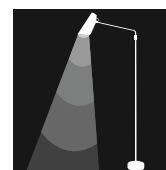
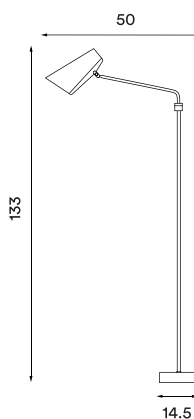

## Recommended bulb:

 LED – 7 W



Prices NOK	(RRP ex. VAT)	(RRP incl. VAT)	Prices SEK	(RRP ex. VAT)	(RRP incl. VAT)
	3 992,-	4 990,-		4 392,-	5 490,-
Prices DKK	(RRP ex. VAT)	(RRP incl. VAT)	Prices Euro	(RRP ex. VAT)	(RRP incl. VAT)
	3 192,-	3 990,-		458,-	549,-



# Birdy table

P. 13



Birdy table black/ brass  
- Item no. 600



Birdy table white/ steel  
- Item no. 601



Birdy table grey/ steel  
- Item no. 602



Birdy table black/ black  
- Item no. 604



Birdy table black/ steel  
- Item no. 605

**Product type:** Table lamp  
**Design:** Birger Dahl, 1952  
**Shade material:** Aluminium  
**Shade, base and handle colours:** White, grey or black (shade inner colour is same as outer colour)  
**Body material:** Steel  
**Body and joints colour:** Steel, brass or black  
**Wire:** Black (grey and black versions only) or white (white version only), 200 cm (with switch)  
**Bulb:** E27, Max. 11 W LED only  
**Voltage:** 220V - 240V - 50/60Hz  
**Net weight:** 1.9 kg  
**Minimum order size:** 2

## Dimensions and light direction:

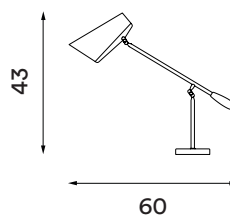

## Recommended bulb:



Prices NOK	(RRP ex. VAT)	(RRP incl. VAT)	Prices SEK	(RRP ex. VAT)	(RRP incl. VAT)
	2 952,-	3 690,-		3 192,-	3 990,-
Prices DKK	(RRP ex. VAT)	(RRP incl. VAT)	Prices Euro	(RRP ex. VAT)	(RRP incl. VAT)
	2 392,-	2 990,-		333,-	399,-



# Birdy table swing

P. 14



Birdy table swing black / brass  
– Item no. 606



Birdy table swing black / black  
– Item no. 607



Birdy table swing black / steel  
– Item no. 608

**Product type:** Table lamp

**Design:** Birger Dahl, 1952/2021

**Shade material:** Aluminium

**Shade and base colours:** Black (shade inner colour is same as outer colour)

**Body material:** Steel

**Body and joints colour:** Brass, black or steel

**Wire:** Black, 200 cm

**Switch:** On/off switch on the shade

**Bulb:** E27, Max. 11 W LED only

**Voltage:** 220V - 240V - 50/60Hz

**Net weight:** 2.9 kg

**Minimum order size:** 2

## Dimensions and light direction:

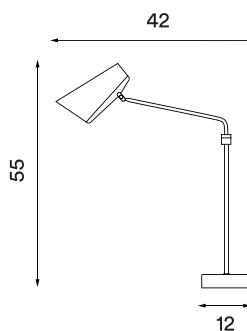

## Recommended bulb:

 LED – 7 W



## Prices NOK

(RRP ex. VAT) (RRP incl. VAT)

2 952,-	3 690,-
---------	---------

## Prices SEK

(RRP ex. VAT) (RRP incl. VAT)

3 192,-	3 990,-
---------	---------

## Prices DKK

(RRP ex. VAT) (RRP incl. VAT)

2 392,-	2 990,-
---------	---------

## Prices Euro

(RRP ex. VAT) (RRP incl. VAT)

333,-	399,-
-------	-------



# Birdy wall

P. 15

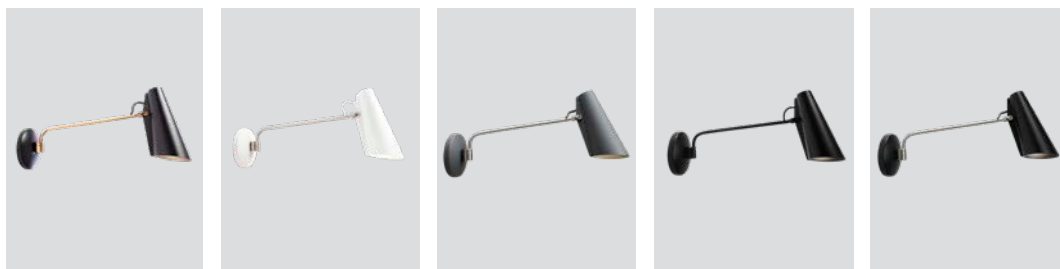

Birdy wall swing  
black / brass  
– Item no. 610

Birdy wall swing  
white / steel  
– Item no. 611

Birdy wall swing  
grey / steel  
– Item no. 612

Birdy wall swing  
black / black  
– Item no. 613

Birdy wall swing  
black / steel  
– Item no. 614

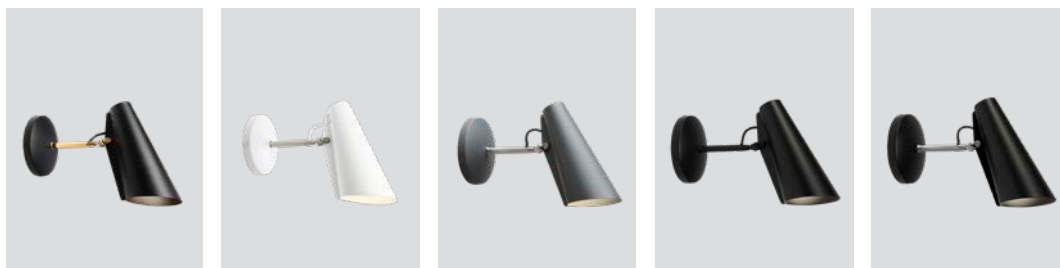

Birdy wall short  
black / brass  
– Item no. 615

Birdy wall short  
white / steel  
– Item no. 616

Birdy wall short  
grey / steel  
– Item no. 617

Birdy wall short  
black / black  
– Item no. 618

Birdy wall short  
black / steel  
– Item no. 619

**Product type:** Wall lamp

**Design:** Birger Dahl, 1952

**Shade material:** Aluminium

**Shade and base colours:** White, grey or black  
(shade inner colour is same as outer colour)

**Body material:** Steel

**Body and joints colour:** Steel, brass or black

**Wire:** Black (grey or black versions only) or white  
(white version only), 200 cm

**Switch:** On/off switch on the wire

**Bulb:** E27, Max. 11 W LED only

**Voltage:** 220V - 240V - 50/60Hz

**Net weight:** Birdy wall swing: 0.8 kg,

Birdy wall short: 0.7 kg

**Minimum order size:** 2

**Dimensions and light direction:**

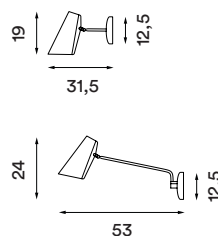

**Recommended bulb:**

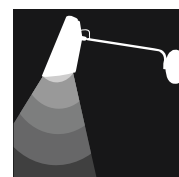

Prices NOK	(RRP ex. VAT)	(RRP incl. VAT)	Prices SEK	(RRP ex. VAT)	(RRP incl. VAT)
Long arm	2 632,-	3 290,-	Long arm	2 952,-	3 690,-
Short arm	2 392,-	2 990,-	Short arm	2 632,-	3 290,-
Prices DKK	(RRP ex. VAT)	(RRP incl. VAT)	Prices Euro	(RRP ex. VAT)	(RRP incl. VAT)
Long arm	2 152,-	2 690,-	Long arm	308,-	369,-
Short arm	1 992,-	2 490,-	Short arm	274,-	329,-



# Blush pendant

P. 16

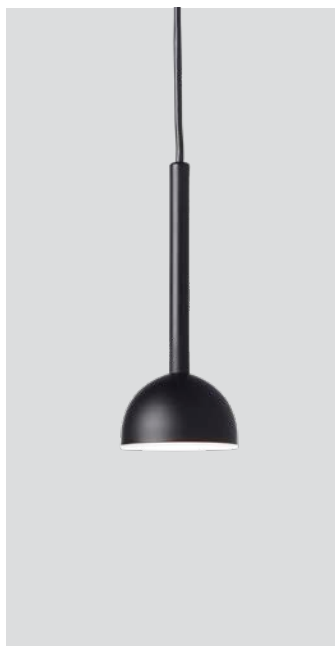

Blush pendant black matt  
- Item no. 115



Blush pendant white matt  
- Item no. 119

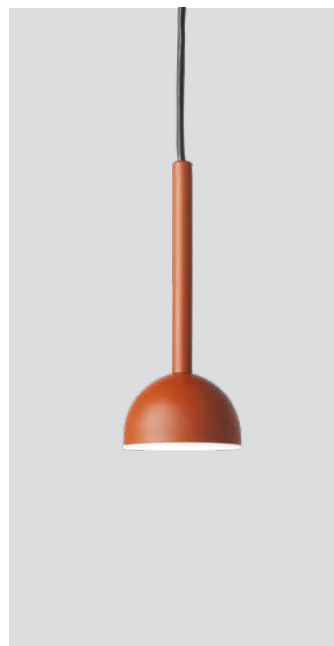

Blush pendant rust  
- Item no. 118

**Product type:** Pendant lamp

**Design:** Morten & Jonas, 2019

**Shade and body material:** Steel

**Shade and body colours:** Black, white or rust

**Light diffuser material:** Opal acrylic

**Wire:** Black (black and rust version) or white (white version), 370 cm

**Bulb:** Integrated and dimmable LED 6 W, 550 lm, 2700 K, CRI > 85

**Voltage:** 220V - 240V - 50/60Hz

**Net weight:** 0.70 kg

**Minimum order size:** 2

**Spare parts available:** LED module

## Dimensions and light direction:

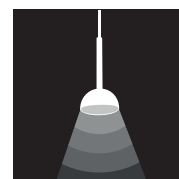
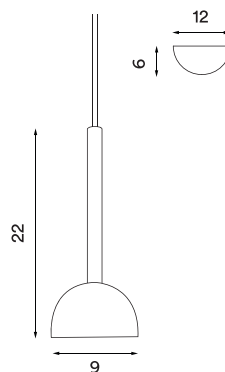

## Light source included:

LED 6 W - Energy class: G



Prices NOK	(RRP ex. VAT)	(RRP incl. VAT)	Prices SEK	(RRP ex. VAT)	(RRP incl. VAT)
	1 752,-	2 190,-		1 912,-	2 390,-
Prices DKK	(RRP ex. VAT)	(RRP incl. VAT)	Prices EUR	(RRP ex. VAT)	(RRP incl. VAT)
	1 432,-	1 790,-		199,-	239,-





# Blush pendant rail 3

P. 17

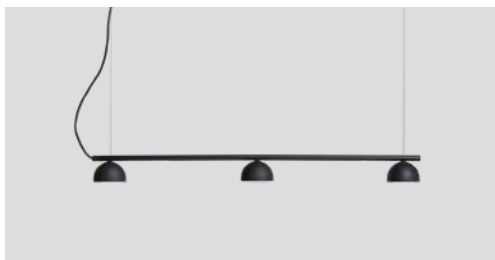

Blush pendant rail 3 black  
- Item no. 150

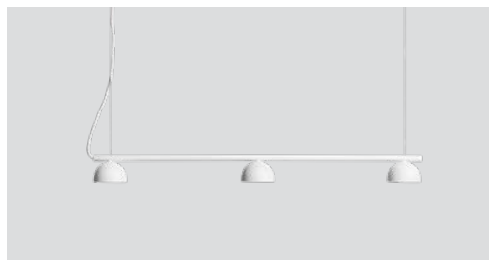

Blush pendant rail 3 white  
- Item no. 152

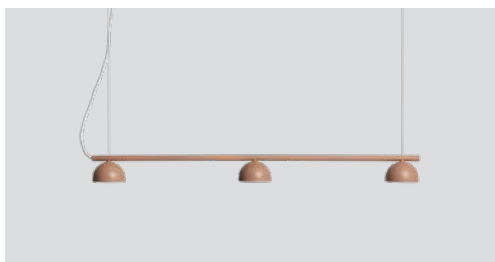

Blush pendant rail 3 warm beige  
- Item no. 154

**Product type:** Pendant lamp  
**Design:** Morten & Jonas, 2022  
**Shade and body material:** Steel  
**Shade and body colours:** Black, white or warm beige  
**Light diffuser material:** Opal acrylic  
**Wire:** Black (black version) or white (white and warm beige version), 370 cm  
**Steel hanging wire:** 360 cm  
**Bulb:** Integrated and dimmable LED 3 x 6 W, 1650 lm, 2700 K, CRI > 85  
**Voltage:** 220V - 240V - 50/60Hz  
**Net weight:** 1.8 kg  
**Minimum order size:** 2  
**Spare parts available:** LED module

## Dimensions and light direction:

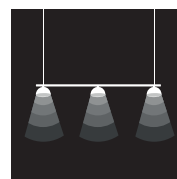
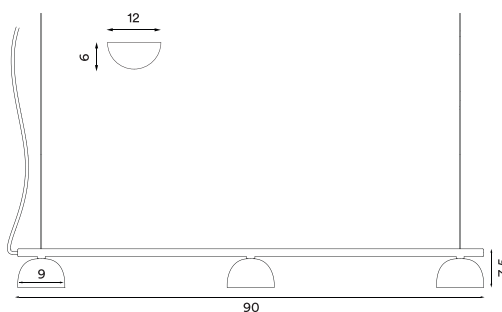

## Light source included:

LED 3 x 6 W - Energy class: G



Prices NOK	(RRP ex. VAT)	(RRP incl. VAT)
	3 912,-	4 890,-

Prices SEK	(RRP ex. VAT)	(RRP incl. VAT)
	4 312,-	5 390,-

Prices DKK	(RRP ex. VAT)	(RRP incl. VAT)
	3 192,-	3 990,-

Prices EUR	(RRP ex. VAT)	(RRP incl. VAT)
	441,-	529,-



# Blush pendant rail 5

P. 18

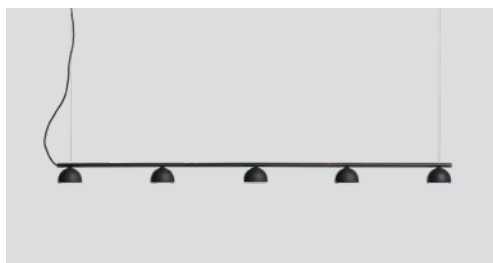

Blush pendant rail 5 black  
- Item no. 151



Blush pendant rail 5 white  
- Item no. 153

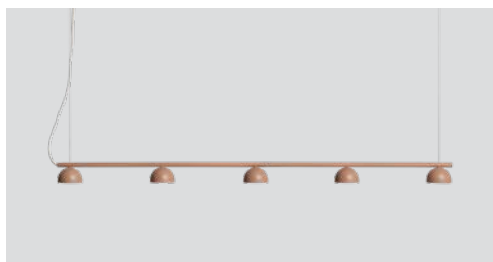

Blush pendant rail 5 warm beige  
- Item no. 155

**Product type:** Pendant lamp  
**Design:** Morten & Jonas, 2022  
**Shade and body material:** Steel  
**Shade and body colours:** Black, white or warm beige  
**Light diffuser material:** Opal acrylic  
**Wire:** Black (black version) or white (white and warm beige version), 370 cm  
**Steel hanging wire:** 360 cm  
**Bulb:** Integrated and dimmable LED 5 x 6 W, 3300 lm, 2700 K, CRI > 85  
**Voltage:** 220V - 240V - 50/60Hz  
**Net weight:** 2.4 kg  
**Minimum order size:** 2  
**Spare parts available:** LED module

## Dimensions and light direction:

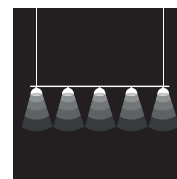
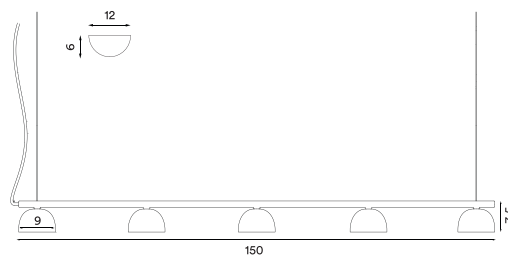

## Light source included:

LED 5 x 6 W - Energy class: G



Prices NOK	(RRP ex. VAT)	(RRP incl. VAT)
	5 592,-	6 990,-

Prices SEK	(RRP ex. VAT)	(RRP incl. VAT)
	6 152,-	7 690,-

Prices DKK	(RRP ex. VAT)	(RRP incl. VAT)
	4 472,-	5 590,-

Prices EUR	(RRP ex. VAT)	(RRP incl. VAT)
	624,-	749,-





Blush wall black matt  
– Item no. 113



Blush wall pink  
– Item no. 111



Blush wall white matt  
– Item no. 114

**Product type:** Wall lamp

**Design:** Morten & Jonas, 2018

**Shade material:** Steel

**Body materials:** Steel and silicone,  
brass flexible arm

**Shade and body colours:** Black, pink or white

**Light diffuser material:** Opal acrylic

**Wire:** Black (black version only) or  
white (pink or white versions), 200 cm

**Switch:** Dimmer switch on the wall base

**Bulb:** Integrated and dimmable LED 6 W,  
550 lm, 2700 K, CRI > 85

**Voltage:** 220V - 240V - 50/60Hz

**Net weight:** 0.60 kg

**Minimum order size:** 2

**Spare parts available:** LED module

**Dimensions and light direction:**

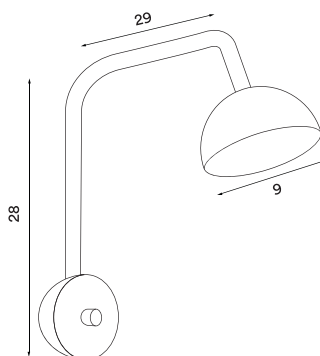

**Light source included:**

LED 6 W - Energy class: G



Prices NOK	(RRP ex. VAT)	(RRP incl. VAT)	Prices SEK	(RRP ex. VAT)	(RRP incl. VAT)
	2 312,-	2 890,-		2 552,-	3 190,-
Prices DKK	(RRP ex. VAT)	(RRP incl. VAT)	Prices EUR	(RRP ex. VAT)	(RRP incl. VAT)
	1 832,-	2 290,-		249,-	299,-

# Buddy floor

P. 20



Buddy floor white  
– Item no. 240

Buddy floor dark grey  
– Item no. 241

Buddy floor dark green  
– Item no. 242

Buddy floor warm beige  
– Item no. 243

Buddy floor black  
– Item no. 248

**Product type:** Floor lamp

**Design:** Mads Sætter-Lassen, 2019

**Shade and body material:** Steel

**Colours:** White, dark grey, dark green, warm beige or black (shade inner colour is same as outer colour)

**Wire:** Black or white (white version only), 200 cm

**Switch:** Dimmer switch on the floor base

**Bulb:** GU10, Max. 6 W LED only (dimmable)

**Voltage:** 220V - 240V - 50/60Hz

**Net weight:** 7.3 kg

**Minimum order size:** 1

## Dimensions and light direction:

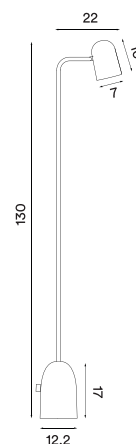

**Recommended dimmable bulb:**



**Prices NOK**

**(RRP ex. VAT) (RRP incl. VAT)**

3 592,-	4 490,-
---------	---------

**Prices SEK**

**(RRP ex. VAT) (RRP incl. VAT)**

3 992,-	4 990,-
---------	---------

**Prices DKK**

**(RRP ex. VAT) (RRP incl. VAT)**

2 872,-	3 590,-
---------	---------

**Prices Euro**

**(RRP ex. VAT) (RRP incl. VAT)**

408,-	489,-
-------	-------



# Buddy table

P. 21



Buddy table white  
– Item no. 230

Buddy table dark grey  
– Item no. 233

Buddy table dark green  
– Item no. 238

Buddy table warm beige  
– Item no. 239

Buddy table black  
– Item no. 249

**Product type:** Table lamp

**Design:** Mads Sætter-Lassen, 2016

**Shade and body material:** Steel

**Colours:** White, dark grey, dark green, warm beige or black (shade inner colour is same as outer colour)

**Wire:** Black or white (white version only), 200 cm

**Switch:** On/off switch on the wire

**Bulb:** GU10, Max. 6 W LED only

**Voltage:** 220V - 240V - 50Hz

**Net weight:** 2.1 kg

**Minimum order size:** 2

**Dimensions and light direction:**

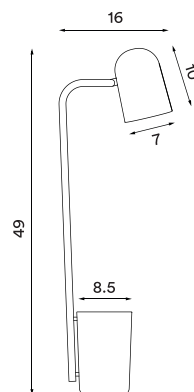

**Recommended bulb:**



**Prices NOK**

**(RRP ex. VAT) (RRP incl. VAT)**

2 312,-	2 890,-
---------	---------

**Prices SEK**

**(RRP ex. VAT) (RRP incl. VAT)**

2 552,-	3 190,-
---------	---------

**Prices DKK**

**(RRP ex. VAT) (RRP incl. VAT)**

1 832,-	2 290,-
---------	---------

**Prices Euro**

**(RRP ex. VAT) (RRP incl. VAT)**

249,-	299,-
-------	-------



# Buddy wall

P. 22



Buddy wall white  
– Item no. 220



Buddy wall dark grey  
– Item no. 221



Buddy wall dark green  
– Item no. 222



Buddy wall warm beige  
– Item no. 223



Buddy wall black  
– Item no. 224

**Product type:** Wall lamp

**Design:** Mads Sætter-Lassen, 2017

**Shade and body material:** Steel

**Colours:** White, dark grey, dark green, warm beige or black (shade inner colour is same as outer colour)

**Wire:** Black or white (white version only), 200 cm

**Switch:** Dimmer switch on the wall base

**Bulb:** GU10, Max. 6 W LED only (dimmable)

**Voltage:** 220V - 240V - 50/60Hz

**Net weight:** 0.4 kg

**Minimum order size:** 2

**Dimensions and light direction:**

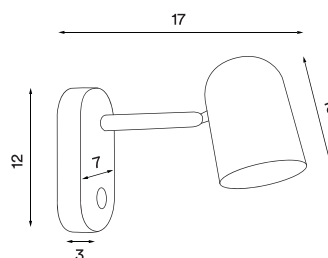

**Recommended dimmable bulb:**



Prices NOK	(RRP ex. VAT)	(RRP incl. VAT)	Prices SEK	(RRP ex. VAT)	(RRP incl. VAT)
	1 832,-	2 290,-		1 992,-	2 490,-
Prices DKK	(RRP ex. VAT)	(RRP incl. VAT)	Prices Euro	(RRP ex. VAT)	(RRP incl. VAT)
	1 432,-	1 790,-		208,-	249,-





# Butterfly wall

P. 23



Butterfly white  
– Item no. 320



Butterfly brass  
– Item no. 322



Butterfly dark green  
– Item no. 323



Butterfly black  
– Item no. 321



Butterfly aluminium  
– Item no. 329

**Product type:** Wall lamp

**Design:** Sven I. Dysthe, 1964

**Shade material:** Steel, brass or aluminium

**Shade colour:** White, black, dark green,  
brushed brass or brushed aluminium

**Body material:** Steel

**Body colour:** White, black, brass, steel or dark green

**Wire:** White silk (white version), black silk (brass, black,  
aluminium and dark green versions), 200 cm

**Bulb:** E27, Max. 60 W

**Voltage:** 220V - 240V - 50/60Hz

**Net weight:** 1,2 kg (white, black, brass and dark green  
versions), 0,8 kg (aluminium version)

**Minimum order size:** 2

**Spare part available:** Wall bracket

**Dimensions and light direction:**

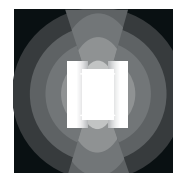
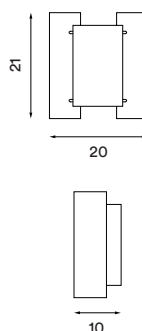

**Recommended bulb:**



Prices NOK	(RRP ex. VAT)	(RRP incl. VAT)
White, black, dark green	2 392,-	2 990,-
Aluminium	2 792,-	3 490,-
Brass	3 192,-	3 990,-

Prices DKK	(RRP ex. VAT)	(RRP incl. VAT)
White, black, dark green	1 912,-	2 390,-
Aluminium	2 232,-	2 790,-
Brass	2 632,-	3 290,-

Prices SEK	(RRP ex. VAT)	(RRP incl. VAT)
White, black, dark green	2 632,-	3 290,-
Aluminium	3 032,-	3 790,-
Brass	3 512,-	4 390,-

Prices Euro	(RRP ex. VAT)	(RRP incl. VAT)
White, black, dark green	266,-	319,-
Aluminium	316,-	379,-
Brass	374,-	449,-



# Butterfly perforated wall

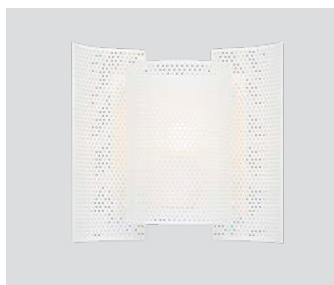

Butterfly perforated white  
– Item no. 324

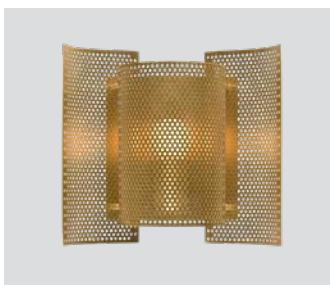

Butterfly perforated brass  
– Item no. 325

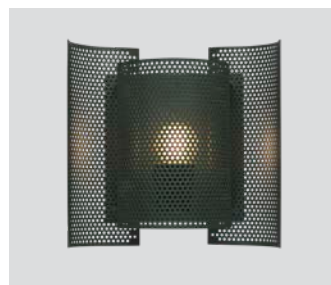

Butterfly perforated dark green  
– Item no. 326



Butterfly perforated black  
– Item no. 327



Butterfly perforated aluminium  
– Item no. 328

**Product type:** Wall lamp

**Design:** Sven I. Dysthe, 1964

**Shade material:** Steel, brass or aluminium

**Shade colour:** White, black, dark green,  
brushed brass or brushed aluminium

**Body material:** Steel

**Body colour:** White, black, dark green, brass or steel

**Wire:** White silk (white version), black silk (brass, black,  
aluminium and dark green versions), 200 cm

**Switch:** Detachable pull string switch (on/off)

**Bulb:** E27, Max. 60 W

**Voltage:** 220V - 240V - 50/60Hz

**Net weight:** 1.2 kg (white, black, brass and dark green  
versions), 0,8 kg (aluminium version)

**Minimum order size:** 2

**Spare part available:** Wall bracket

## Dimensions and light direction:

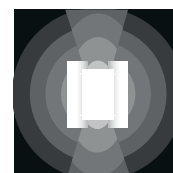
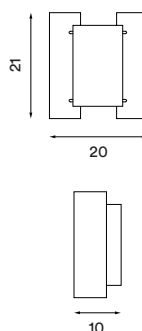

## Recommended bulb:

 LED – 11 W



Prices NOK	(RRP ex. VAT)	(RRP incl. VAT)
White, black, dark green	2 392,-	2 990,-
Aluminium	2 792,-	3 490,-
Brass	3 192,-	3 990,-

Prices DKK	(RRP ex. VAT)	(RRP incl. VAT)
White, black, dark green	1 912,-	2 390,-
Aluminium	2 232,-	2 790,-
Brass	2 632,-	3 290,-

Prices SEK	(RRP ex. VAT)	(RRP incl. VAT)
White, black, dark green	2 632,-	3 290,-
Aluminium	3 032,-	3 790,-
Brass	3 512,-	4 390,-

Prices Euro	(RRP ex. VAT)	(RRP incl. VAT)
White, black, dark green	266,-	319,-
Aluminium	316,-	379,-
Brass	374,-	449,-



# Circle pendant

P. 25

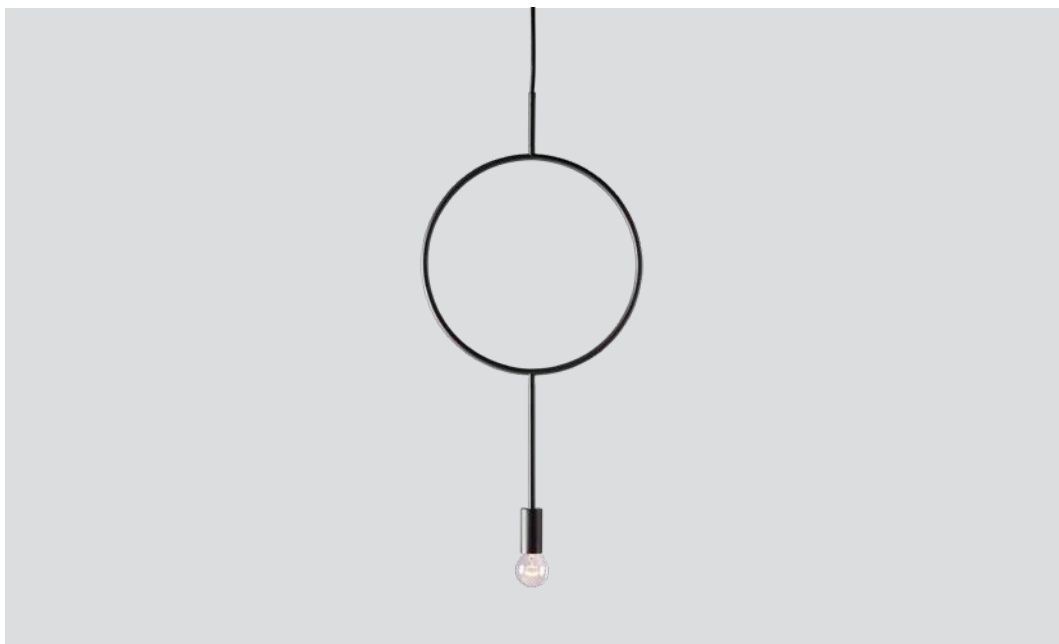

Circle

– Item no. 666

**Product type:** Pendant lamp  
**Design:** Hannakaisa Pekkala, 2017  
**Body colour:** Dark grey  
**Body material:** Steel  
**Wire:** Black rubber, 370 cm  
**Bulb:** E14, Max. 40 W  
**Voltage:** 220V - 240V - 50Hz  
**Net weight:** 0.6 kg  
**Minimum order size:** 2

## Dimensions and light direction:

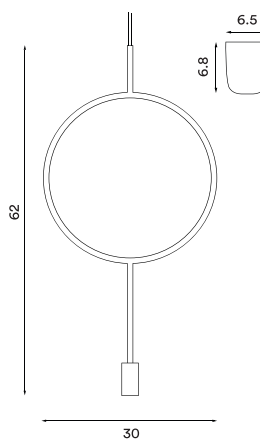

## Recommended bulb:

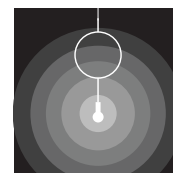

Prices NOK	(RRP ex. VAT)	(RRP incl. VAT)	Prices SEK	(RRP ex. VAT)	(RRP incl. VAT)
	1 592,-	1 990,-		1 752,-	2 190,-
Prices DKK	(RRP ex. VAT)	(RRP incl. VAT)	Prices Euro	(RRP ex. VAT)	(RRP incl. VAT)
	1 272,-	1 590,-		183,-	219,-



# Dahl pendant

P. 26



Dahl small hanging part brass matt – *Item no. 491*

Dahl small glass shade – *Item no. 495*



Dahl small hanging part dark grey – *Item no. 492*

Dahl small glass shade – *Item no. 495*



Dahl large hanging part brass matt – *Item no. 445*

Dahl large glass shade – *Item no. 444*



Dahl large hanging part dark grey – *Item no. 446*

Dahl large glass shade – *Item no. 444*

**Product type:** Pendant lamp series

**Design:** Birger Dahl, 1956

**Shade material:** Glass

**Shade colour:** Opal white matt

**Body material:** Steel

**Body colours:** Brass matt or dark grey

**Wire:** Black rubber, 370 cm

**Bulb:** E27, Max. 40 W (small),

E27, Max. 100 W (large)

**Voltage:** 220V - 240V - 50Hz

**Net weight:** 0.8 Kg (small), 2.1 Kg (large)

**Minimum order size:** 2

**Spare parts available:** Light diffuser ring, cord grip canopy, glass shade

**Dimensions and light direction:**

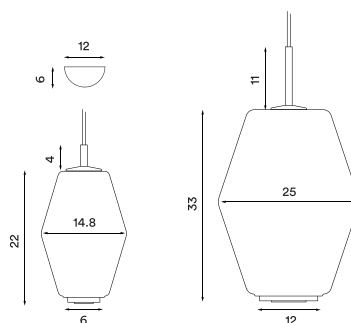

**Recommended bulbs:**

LED – 7 W

LED – 9 W

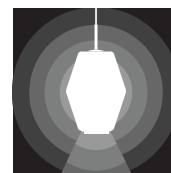

Prices NOK	(RRP ex. VAT)	(RRP incl. VAT)
Dahl small	2 392,-	2 990,-
Dahl large	3 032,-	3 790,-

Prices SEK	(RRP ex. VAT)	(RRP incl. VAT)
Dahl small	2 632,-	3 290,-
Dahl large	3 352,-	4 190,-

Prices DKK	(RRP ex. VAT)	(RRP incl. VAT)
Dahl small	1 912,-	2 390,-
Dahl large	2 392,-	2 990,-

Prices Euro	(RRP ex. VAT)	(RRP incl. VAT)
Dahl small	274,-	329,-
Dahl large	332,-	399,-



# Diva pendant / floor

P. 27



Diva floor oak  
– Item no. 370



Diva floor smoked oak  
– Item no. 372



Diva pendant oak  
– Item no. 380



Diva pendant smoked oak  
– Item no. 382

Diva floor base – Item no. 390

Diva hanging part – Item no. 391

**Product type:** Floor lamp and pendant lamp series  
**Design:** Peter Natedal & Thomas Kalvatn Egset, 2009  
**Shade material and colour:** Oak or smoked oak, laminated plywood  
**Glass shade material:** Mouth blown glass  
**Glass shade colour:** Opal white matt  
**Body material and colour:** Steel  
**Wire:** Transparent, 200 cm (floor) and 370 cm (pendant)  
**Dimmer switch:** Transparent (floor lamp only)  
**Bulb:** G9, Max. 6 W LED only (dimmable)  
**Voltage:** 220V - 240V - 50/60Hz  
**Net weight:** 7 kg (floor lamp), 4.5 kg (pendant lamp)  
**Minimum order size:** 1  
**Spare parts available:** Glass shade

## Dimensions and light direction:

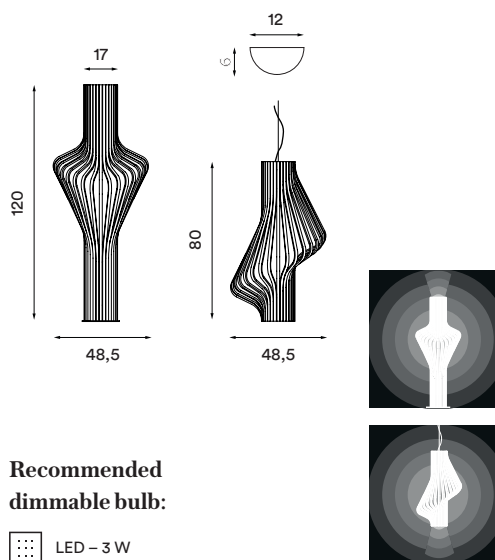

Prices NOK	(RRP ex. VAT)	(RRP incl. VAT)
	23 992,-	29 990,-

Prices SEK	(RRP ex. VAT)	(RRP incl. VAT)
	26 392,-	32 990,-

Prices DKK	(RRP ex. VAT)	(RRP incl. VAT)
	19 592,-	24 490,-

Prices Euro	(RRP ex. VAT)	(RRP incl. VAT)
	2 749,-	3 299,-



# Dokka pendant

P. 28



Dokka dark green  
– Item no. 251



Dokka light yellow  
– Item no. 252



Dokka rust  
– Item no. 253



Dokka dark grey  
– Item no. 256



Dokka white matt  
– Item no. 274



Dokka black matt  
– Item no. 275



Dokka warm beige  
– Item no. 276



Dokka steel  
– Item no. 277

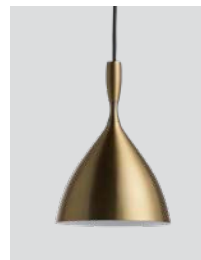

Dokka brass  
– Item no. 278

**Product type:** Pendant lamp

**Design:** Birger Dahl, 1954

**Shade material:** Steel or brass (brass version only)

**Shade ring material:** Brass

**Shade colours:** Dark green, light yellow, rust, dark grey, white matt, black matt, warm beige, brushed steel or brushed brass

**Shade inner colour:** White

**Wire:** White rubber (white version only) or black rubber (all other versions), 370 cm

**Bulb:** E27, Max. 60 W

**Voltage:** 220V - 240V - 50/60Hz

**Net weight:** 0.9 kg

**Minimum order size:** 2

**Spare part available:** Cord grip canopy

**Dimensions and light direction:**

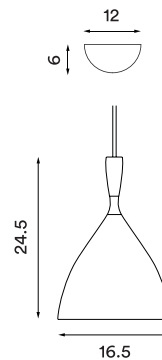

**Recommended bulb:**



Prices NOK	(RRP ex. VAT)	(RRP incl. VAT)
Steel versions	2 152,-	2 690,-
Brass	2 632,-	3 290,-

Prices SEK	(RRP ex. VAT)	(RRP incl. VAT)
Steel versions	2 292,-	2 990,-
Brass	2 872,-	3 590,-

Prices DKK	(RRP ex. VAT)	(RRP incl. VAT)
Steel versions	1 752,-	2 190,-
Brass	2 072,-	2 590,-

Prices Euro	(RRP ex. VAT)	(RRP incl. VAT)
Steel versions	241,-	289,-
Brass	291,-	349,-







Gear floor  
– Item no. 410

**Product type:** Floor lamp  
**Design:** Johan Lindstén, 2018  
**Base, body and shade material:** Steel  
**Base, body and shade colour:** Black  
**Shade inner colour:** White  
**Wire (with dimmer switch):** Black, 200 cm  
**Bulb:** E27, Max. 100 W (dimmable)  
**Voltage:** 220V - 240V - 50/60Hz  
**Net weight:** 17.1 kg  
**Minimum order size:** 1

**Dimensions and light direction:**

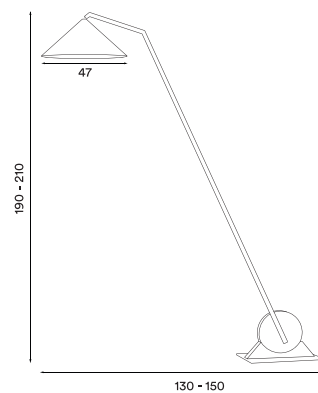

**Recommended dimmable bulb:**

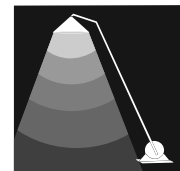

Prices NOK	(RRP ex. VAT)	(RRP incl. VAT)
	15 992,-	19 990,-

Prices SEK	(RRP ex. VAT)	(RRP incl. VAT)
	17 592,-	21 990,-

Prices DKK	(RRP ex. VAT)	(RRP incl. VAT)
	12 792,-	15 990,-

Prices Euro	(RRP ex. VAT)	(RRP incl. VAT)
	1 833,-	2 199,-



Gear table  
– Item no. 411

**Product type:** Table lamp  
**Design:** Johan Lindstén, 2018  
**Base, body and shade material:** Steel  
**Base, body and shade colour:** Black  
**Shade inner colour:** White  
**Wire (with dimmer switch):** Black, 200 cm  
**Bulb:** E27, Max. 60 W (dimmable)  
**Voltage:** 220V - 240V - 50/60Hz  
**Net weight:** 6.1 kg  
**Minimum order size:** 1

**Dimensions and light direction:**

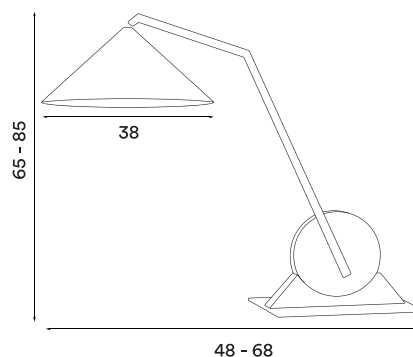

**Recommended dimmable bulb:**

 LED – 11 W

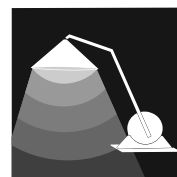

Prices NOK	(RRP ex. VAT)	(RRP incl. VAT)
	7 992,-	9 990,-

Prices SEK	(RRP ex. VAT)	(RRP incl. VAT)
	8 792,-	10 990,-

Prices DKK	(RRP ex. VAT)	(RRP incl. VAT)
	6 392,-	7 990,-

Prices Euro	(RRP ex. VAT)	(RRP incl. VAT)
	916,-	1 099,-

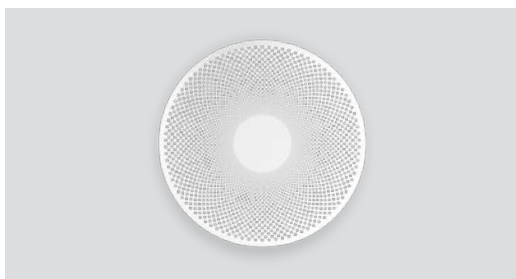

Glint wall white  
– Item no. 265



Glint wall brass  
– Item no. 266



Glint wall aluminium  
– Item no. 267

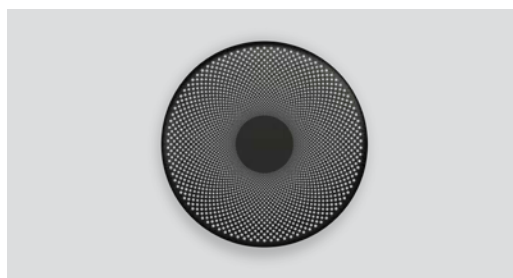

Glint wall black  
– Item no. 268

**Product type:** Wall lamp

**Design:** Felix Isidorsson, 2022

**Shade material:** Steel, brass or aluminium

**Shade colour:** White, brushed brass, brushed aluminium or black

**Body material:** Steel

**Body colour:** White or black (black version only)

**Wire:** White (white and brass versions), black (black version) or transparent (aluminium version), 200 cm (with on/off switch)

**Bulb:** Integrated and dimmable LED 6 W, 550 lm, 2700 K, CRI > 85

**Voltage:** 220V - 240V - 50/60Hz

**Net weight:** 1.2 kg (white, black and brass versions), 0.8 kg (aluminium version)

**Minimum order size:** 2

**Spare parts available:** LED module

**Dimensions and light direction:**

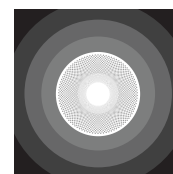
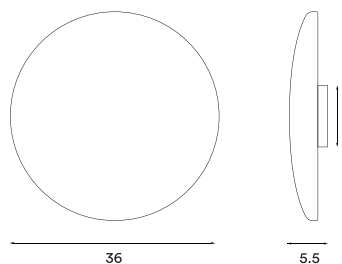

**Light source included:**

LED 6 W - Energy class: G



**Prices NOK** (RRP ex. VAT) (RRP incl. VAT)

White, black, alu	3 112,-	3 890,-
Brass	4 792,-	5 990,-

**Prices DKK** (RRP ex. VAT) (RRP incl. VAT)

White, black, alu	2 552,-	3 190,-
Brass	3 912,-	4 890,-

**Prices SEK** (RRP ex. VAT) (RRP incl. VAT)

White, black, alu	3 432,-	4 290,-
Brass	5 352,-	6 690,-

**Prices Euro** (RRP ex. VAT) (RRP incl. VAT)

White, black, alu	358,-	429,-
Brass	549,-	659,-



# Heat pendant

P. 32



Heat pendant small brass  
– Item no. 482



Heat pendant large brass  
– Item no. 481



Heat pendant XL brass  
– Item no. 485



Heat pendant small steel  
– Item no. 483



Heat pendant large steel  
– Item no. 484



Heat pendant XL steel  
– Item no. 486

**Product type:** Pendant lamp series  
**Design:** Johanna Forsberg, 2018  
**Shade material:** Brass or steel metal mesh  
**Shade colour:** Brass or steel  
**Body material:** Steel  
**Body colour:** Brass or steel  
**Wire:** Black rubber, 370 cm  
**Bulb:** E27, Max. 100 W  
**Voltage:** 220V - 240V - 50/60Hz  
**Net weight small:** 1.0 kg  
**Net weight large:** 2.1 kg  
**Net weight XL:** 4.2 kg (steel), 4.5 kg (brass)  
**Minimum order size:** 1

## Dimensions and light direction:

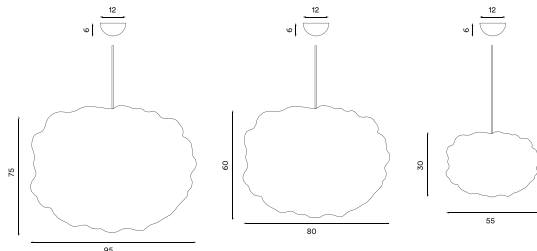

## Recommended bulb:

 LED – 11 W

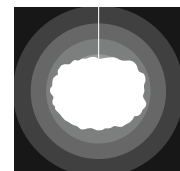

Prices NOK	(RRP ex. VAT)	(RRP incl. VAT)
Small	6 792,-	8 490,-
Large	8 792,-	10 990,-
XL	11 992,-	14 990,-

Prices DKK	(RRP ex. VAT)	(RRP incl. VAT)
Small	5 432,-	6 790,-
Large	6 952,-	8 690,-
XL	9 592,-	11 990,-

Prices SEK	(RRP ex. VAT)	(RRP incl. VAT)
Small	7 352,-	9 190,-
Large	9 592,-	11 990,-
XL	13 192,-	16 490,-

Prices Euro	(RRP ex. VAT)	(RRP incl. VAT)
Small	749,-	899,-
Large	991,-	1 189,-
XL	1 374,-	1 649,-



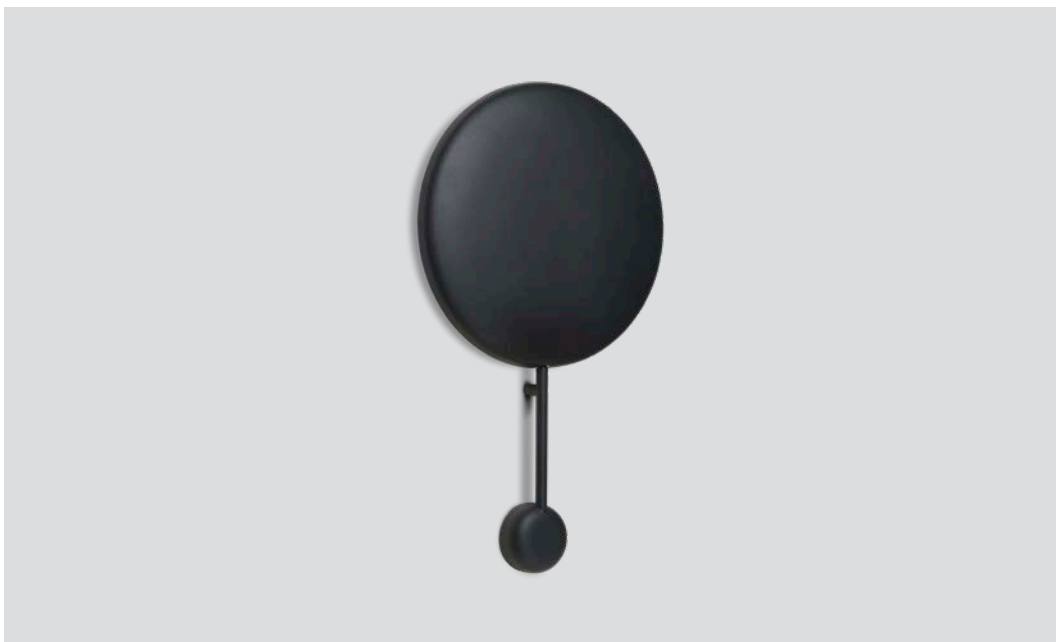

Ink wall black  
- Item no. 269

**Product type:** Wall lamp

**Design:** Felix Isidorsson, 2019

**Shade and body material:** Steel

**Shade and body colour:** Black

**Shade inner colour:** White

**Wire:** Black, 200 cm (with on/off switch)

**Bulb:** Integrated and dimmable LED 6 W, 550 lm, 2700 K, CRI > 85.

**Voltage:** 220V - 240V - 50/60Hz

**Net weight:** 1.8 kg

**Minimum order size:** 2

**Spare parts available:** LED module

**Dimensions and light direction:**

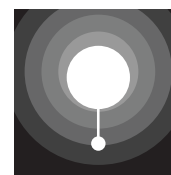
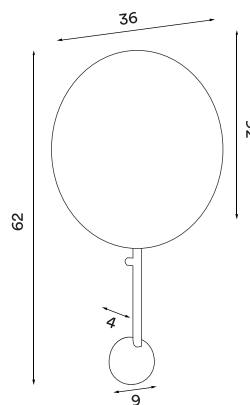

**Light source included:**

LED 6 W - Energy class: G



Prices NOK	(RRP ex. VAT)	(RRP incl. VAT)	Prices SEK	(RRP ex. VAT)	(RRP incl. VAT)
	3 592,-	4 490,-		3 992,-	4 990,-
Prices DKK	(RRP ex. VAT)	(RRP incl. VAT)	Prices Euro	(RRP ex. VAT)	(RRP incl. VAT)
	2 872,-	3 590,-		408,-	489,-

# Me dim floor

P. 34



Me dim floor white  
– Item no. 692

Me dim floor grey  
– Item no. 693

Me dim floor petrol  
blue – Item no. 694

Me dim floor black  
– Item no. 695

Me dim floor warm  
beige – Item no. 696

**Product type:** Floor lamp

**Design:** Morten & Jonas, 2015/2022

**Body materials:** Steel and silicone

**Shade material:** Steel

**Shade and body colours:** White, grey,  
petrol blue, black or warm beige

**Shade inner colour:** White

**Light diffuser material:** Opal acrylic

**Dimmer switch:** Brass (on shade top)

**Wire:** Black, 200 cm

**Bulb:** Integrated and dimmable LED 13 W,  
1200 lm, 2700 K, CRI > 85

**Voltage:** 220V - 240V - 50/60Hz

**Net weight:** 11.3 kg

**Minimum order size:** 1

## Dimensions and light direction:

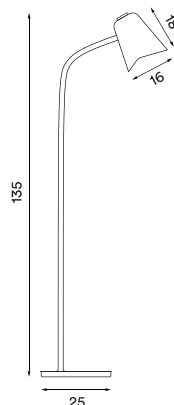

## Light source included:

LED 13 W - Energy class: G



## Prices NOK

(RRP ex. VAT) (RRP incl. VAT)

3 192,- 3 990,-

## Prices SEK

(RRP ex. VAT) (RRP incl. VAT)

3 512,- 4 390,-

## Prices DKK

(RRP ex. VAT) (RRP incl. VAT)

2 632,- 3 290,-

## Prices Euro

(RRP ex. VAT) (RRP incl. VAT)

333,- 399,-



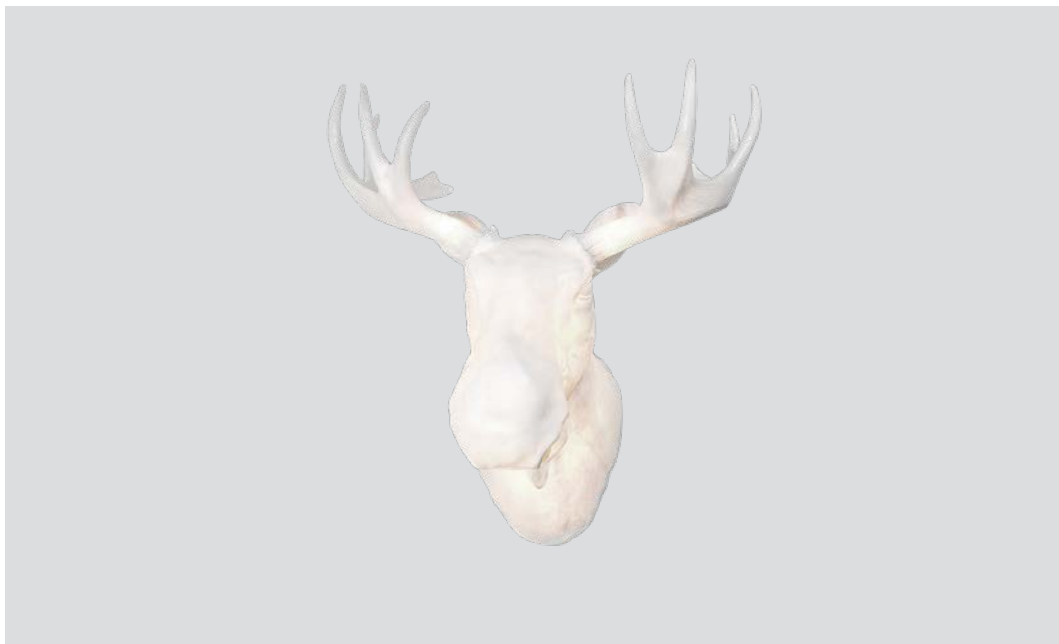

Moo wall  
– Item no. 272

**Product type:** Wall lamp  
**Design:** Trond Svendgård & Ove Rogne, 2008  
**Shade material:** Polyresin and glass fibre  
**Shade colour:** White  
**Body material:** Steel  
**Wire:** White, 200 cm (with on/off switch)  
**Bulbs main body:** 2 x E27, Max. 20W LED  
**Bulbs horns:** 2 x E14, Max. 7 W LED  
**Voltage:** 220V - 240V - 50/60Hz  
**Net weight:** 10 kg  
**Minimum order size:** 1  
**Spare parts available:** Light bulbs (2800K, warm white and 4000K, daylight)

**Dimensions and light direction:**

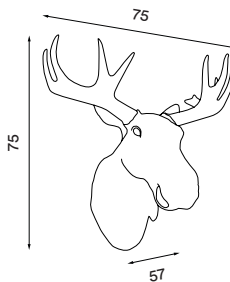

**Bulbs included:**

- 2 x E27 LED 7 W (4000K)
- Energy class: G
- 2 x E14 LED 5.5 W (4000K)
- Energy class: G

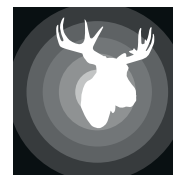

Prices NOK	(RRP ex. VAT)	(RRP incl. VAT)	Prices SEK	(RRP ex. VAT)	(RRP incl. VAT)
	18 792,-	23 490,-		20 792,-	25 990,-
Prices DKK	(RRP ex. VAT)	(RRP incl. VAT)	Prices Euro	(RRP ex. VAT)	(RRP incl. VAT)
	15 192,-	18 990,-		2 083,-	2 499,-

# Ombre table

P. 36



Ombre table black  
– Item no. 130



Ombre table warm beige  
– Item no. 131

**Product type:** Table lamp  
**Design:** Antoine Rouzeau, 2019  
**Shade and body material:** Steel  
**Shade and body colour:** Black or warm beige  
**Wire:** Black, 200 cm (with on/off switch)  
**Bulb:** GU10, Max. 6 W LED only  
**Voltage:** 220V - 240V - 50/60Hz  
**Net weight:** 1.4 kg  
**Minimum order size:** 2

## Dimensions and light direction:

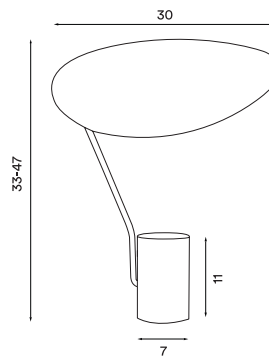

## Recommended bulb:

 LED – 6 W



Prices NOK	(RRP ex. VAT)	(RRP incl. VAT)
	2 952,-	3 690,-

Prices SEK	(RRP ex. VAT)	(RRP incl. VAT)
	3 192,-	3 990,-

Prices DKK	(RRP ex. VAT)	(RRP incl. VAT)
	2 392,-	2 990,-

Prices Euro	(RRP ex. VAT)	(RRP incl. VAT)
	333,-	399,-







Oslo Wood beige shade – *Item no. 160*



Oslo Wood black shade – *Item no. 161*



Oslo Wood light blue shade – *Item no. 162*



Oslo Wood green shade – *Item no. 163*



Oslo Wood white shade – *Item no. 164*



Oslo Wood olive green shade – *Item no. 165*



Oslo Wood caramel shade – *Item no. 166*



Oslo Wood steel feet – *Item no. 180*

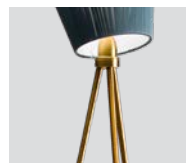

Oslo Wood gold feet – *Item no. 184*



Oslo Wood white matt feet – *Item no. 185*



Oslo Wood black matt feet – *Item no. 186*



Oslo Wood light grey feet – *Item no. 187*



Oslo Wood beige feet – *Item no. 188*

**Product type:** Floor lamp

**Design:** Ove Rogne, 2006

**Shade material:** Coloured chain link fabric

**Shade colour:** Beige, black, light blue, green, olive green, white or caramel

**Body material:** Steel

**Body colour:** Steel, gold, white matt, black matt, light grey or beige

**Wire:** Black, 200 cm

**Dimmer switch:** Black (on wire)

**Bulb:** E27, Max. 100 W (dimnable)

**Voltage:** 220V - 240V - 50/60Hz

**Net weight:** 3.9 kg

**Minimum order size:** 2

**Spare parts available:** Dimmer switch, bulb socket, shade fastening ring

**Dimensions and light direction:**

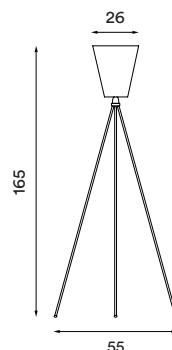

**Recommended dimmable bulb:**

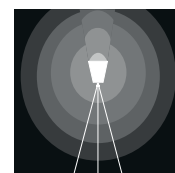

Prices NOK	(RRP ex. VAT)	(RRP incl. VAT)	Prices SEK	(RRP ex. VAT)	(RRP incl. VAT)
Total	4 152,-	5 190,-	Total	4 472,-	5 590,-
Shade	1 440,-	1 800,-	Shade	1 600,-	2 000,-
Feet	2 712,-	3 390,-	Feet	2 872,-	3 590,-

Prices DKK	(RRP ex. VAT)	(RRP incl. VAT)	Prices Euro	(RRP ex. VAT)	(RRP incl. VAT)
Total	3 432,-	4 290,-	Total	466,-	559,-
Shade	1 200,-	1 500,-	Shade	167,-	200,-
Feet	2 232,-	2 790,-	Feet	299,-	359,-



Over Me D20 white – *Item no. 671*  
 Over Me D20 dusty blue – *Item no. 672*  
 Over Me D20 dark grey – *Item no. 673*  
 Over Me D20 black – *Item no. 674*



Over Me D30 white – *Item no. 640*  
 Over Me D30 dusty blue – *Item no. 641*  
 Over Me D30 dark grey – *Item no. 642*  
 Over Me D30 black – *Item no. 675*



Over Me D40 white – *Item no. 643*  
 Over Me D40 dusty blue – *Item no. 644*  
 Over Me D40 dark grey – *Item no. 645*  
 Over Me D40 black – *Item no. 676*



Over Me D50 white – *Item no. 677*  
 Over Me D50 dusty blue – *Item no. 678*  
 Over Me D50 dark grey – *Item no. 680*  
 Over Me D50 black – *Item no. 679*

**Product type:** Ceiling and wall lamp series

**Design:** Morten & Jonas, 2017

**Body material:** Steel

**Body colour:** White, dusty blue, dark grey or black

**Shade material:** Glass

**Shade colour:** Opal white matt

**Bulbs:** E27, Max. 2 x 7 W (P45 size) LED only (D20),

E27, Max. 2 x 13 W LED only (D30)

E27, Max. 3 x 13 W LED only (D40),

E27, Max. 4 x 13 W LED only (D50)

**Voltage:** 220V - 240V - 50/60Hz

**Net weight:** 1.5 kg (D20), 2.0 kg (D30),

3.1 kg (D40), 5.7 kg (D50)

**Minimum order size:** 2

**Spare parts available:** Glass shade

**Dimensions and light direction:**

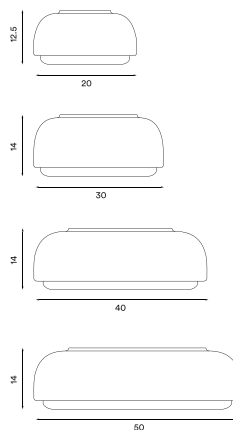

**Recommended bulbs:**



Prices NOK	(RRP ex. VAT)	(RRP incl. VAT)
D20	2 392,-	2 990,-
D30	2 792,-	3 490,-
D40	3 592,-	4 490,-
D50	4 792,-	5 990,-

Prices SEK	(RRP ex. VAT)	(RRP incl. VAT)
D20	2 632,-	3 290,-
D30	3 032,-	3 790,-
D40	3 992,-	4 990,-
D50	5 272,-	6 590,-

Prices DKK	(RRP ex. VAT)	(RRP incl. VAT)
D20	1 992,-	2 490,-
D30	2 232,-	2 790,-
D40	2 872,-	3 590,-
D50	3 832,-	4 790,-

Prices Euro	(RRP ex. VAT)	(RRP incl. VAT)
D20	266,-	319,-
D30	316,-	379,-
D40	408,-	489,-
D50	541,-	649,-



# Reveal pendant

P. 39



Reveal pendant small – *Item no. 190*



Reveal pendant large – *Item no. 191*

**Product type:** Pendant lamp series

**Design:** Silje Nesdal, 2019

**Shade material:** Mouth blown glass

**Shade colour:** Grey

**Body material:** Aluminium and acrylic

**Body colour:** Brass matt and opal white

**Wire:** White rubber, 370 cm

**Bulb:** LED 10 W, 3000 K, 900 lm. Dimmable.

**Voltage:** 220V - 240V - 50/60Hz

**Net weight:** 3.5 kg (small), 4.4 kg (large)

**Minimum order size:** 1

**Dimensions and light direction:**

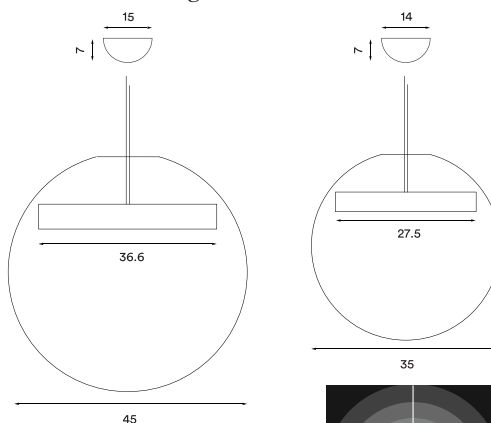

**Light source included:**

LED 10 W - Energy class: G

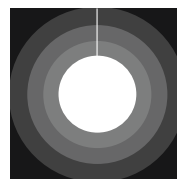

Prices NOK	(RRP ex. VAT)	(RRP incl. VAT)
Small (D35)	5 592,-	6 990,-
Large (D45)	7 592,-	9 490,-

Prices SEK	(RRP ex. VAT)	(RRP incl. VAT)
Small (D35)	6 072,-	7 590,-
Large (D45)	8 232,-	10 290,-

Prices DKK	(RRP ex. VAT)	(RRP incl. VAT)
Small (D35)	4 472,-	5 590,-
Large (D45)	6 072,-	7 590,-

Prices Euro	(RRP ex. VAT)	(RRP incl. VAT)
Small (D35)	624,-	749,-
Large (D45)	849,-	1 019,-



# Salto floor

P. 40

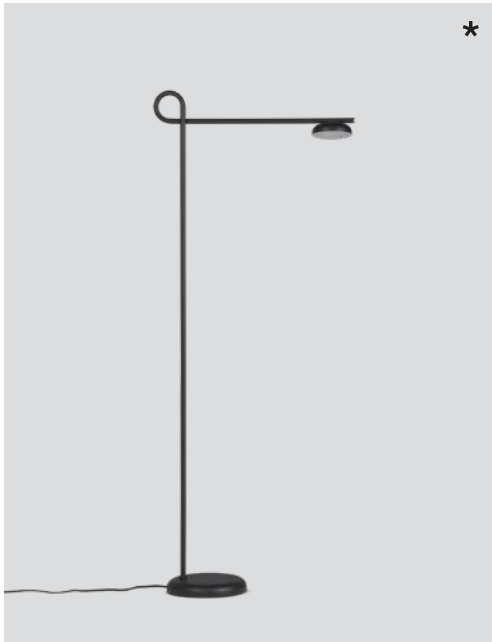

Salto floor black  
– Item no. 734



Salto floor beige  
– Item no. 736

**Product type:** Floor lamp  
**Design:** Gridy, 2022  
**Shade and body material:** Steel  
**Shade and body colour:** Black or beige  
**Light diffuser material:** Opal acrylic  
**Wire:** Black, 200 cm  
**Switch:** 3-step touch dimmer (on lamp)  
**Bulb:** Integrated LED 6 W, 550 lm, 2700 K, CRI > 85, step dim  
**Voltage:** 220V - 240V - 50/60Hz  
**Net weight:** 5.4 kg  
**Minimum order size:** 1

## Dimensions and light direction:

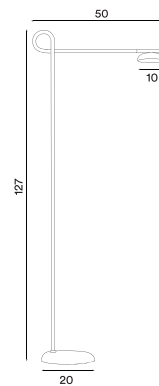

## Light source included:

LED 6 W - Energy class: A



Prices NOK	(RRP ex. VAT)	(RRP incl. VAT)	Prices SEK	(RRP ex. VAT)	(RRP incl. VAT)
	4 152,-	5 190,-		4 552,-	5 690,-
Prices DKK	(RRP ex. VAT)	(RRP incl. VAT)	Prices Euro	(RRP ex. VAT)	(RRP incl. VAT)
	3 352,-	4 190,-		474,-	569,-





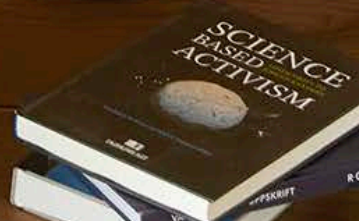



# Salto table

P. 42



Salto table black  
- Item no. 730



Salto table beige  
- Item no. 732

**Product type:** Table lamp  
**Design:** Gridy, 2022  
**Shade and body material:** Steel  
**Shade and body colour:** Black or beige  
**Light diffuser material:** Opal acrylic  
**Wire:** Black, 200 cm  
**Switch:** 3-step touch dimmer (on lamp)  
**Bulb:** Integrated LED 6 W, 550 lm, 2700 K, CRI > 85, step dim  
**Voltage:** 220V - 240V - 50/60Hz  
**Net weight:** 2.5 kg  
**Minimum order size:** 2

## Dimensions and light direction:

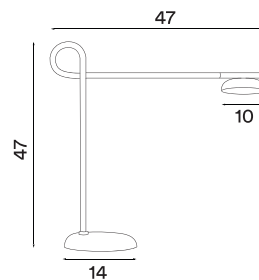

## Light source included:

LED 6 W - Energy class: A



Prices NOK	(RRP ex. VAT)	(RRP incl. VAT)	Prices SEK	(RRP ex. VAT)	(RRP incl. VAT)
	3 112,-	3 890,-		3 432,-	4 290,-
Prices DKK	(RRP ex. VAT)	(RRP incl. VAT)	Prices Euro	(RRP ex. VAT)	(RRP incl. VAT)
	2 552,-	3 190,-		358,-	429,-



# Say My Name pendant / table

P. 43



Say My Name pendant  
smoked grey glossy – *Item no. 660*

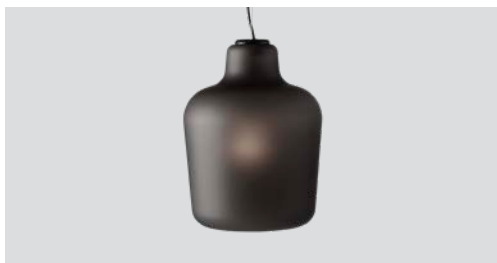

Say My Name pendant  
smoked grey matt – *Item no. 661*



Say My Name table  
smoked grey glossy – *Item no. 662*

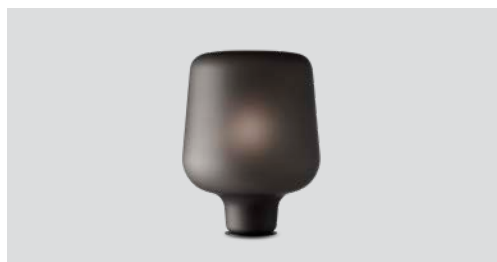

Say My Name table  
smoked grey matt – *Item no. 663*

**Product type:** Pendant and table lamp series

**Design:** Morten & Jonas, 2015

**Shade material:** Mouth blown glass

**Shade colour:** Smoked grey glossy or smoked grey matt

**Base material:** Steel

**Wire:** Black rubber, 370 cm (pendant)  
200 cm with switch (table)

**Bulb:** E27, Max. 60 W

**Voltage:** 220V - 240V - 50Hz

**Net weight:** 5.7 kg (pendant and table)

**Minimum order size:** 1

**Dimensions and light direction:**

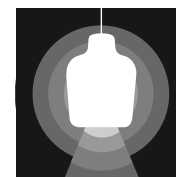
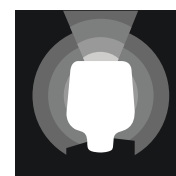
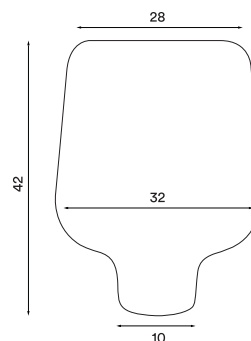

**Recommended bulb:**



**Prices NOK**

(RRP ex. VAT) (RRP incl. VAT)

7 992,- 9 990,-

**Prices SEK**

(RRP ex. VAT) (RRP incl. VAT)

8 792,- 10 990,-

**Prices DKK**

(RRP ex. VAT) (RRP incl. VAT)

6 552,- 8 190,-

**Prices Euro**

(RRP ex. VAT) (RRP incl. VAT)

916,- 1 099,-



# Snowball floor

P. 44

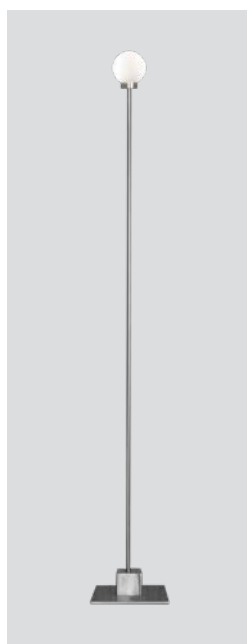

Snowball floor steel  
– Item no. 714



Snowball floor white  
– Item no. 715

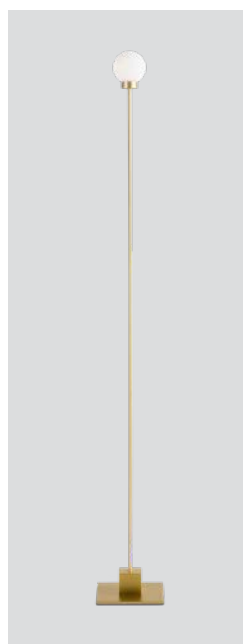

Snowball floor brass  
– Item no. 716

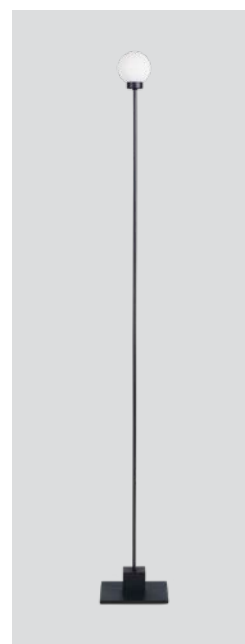

Snowball floor black  
– Item no. 717

**Product type:** Floor lamp

**Design:** Trond Svendgård, 2005

**Body material:** Steel and aluminium or brass

**Body colour:** Steel, white, brass or black

**Shade material:** Mouth blown glass

**Shade colour:** Opal white matt

**Wire (with dimmer switch):** Transparent (steel and white versions), black (black and brass versions), 200 cm

**Bulb:** G9, Max. 6 W LED only (dimmable)

**Voltage:** 220V - 240V - 50/60Hz

**Net weight:** 1.6 kg

**Minimum order size:** 2

**Spare part available:** Glass shade, dimmer switch

**Dimensions and light direction:**

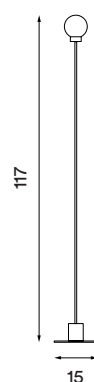

**Recommended dimmable bulb:**



LED – 3 W

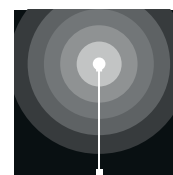

Prices NOK	(RRP ex. VAT)	(RRP incl. VAT)
Steel, white, black	2 392,-	2 990,-
Brass	2 952,-	3 690,-

Prices DKK	(RRP ex. VAT)	(RRP incl. VAT)
Steel, white, black	1 912,-	2 390,-
Brass	2 392,-	2 990,-

Prices SEK	(RRP ex. VAT)	(RRP incl. VAT)
Steel, white, black	2 632,-	3 290,-
Brass	3 192,-	3 990,-

Prices Euro	(RRP ex. VAT)	(RRP incl. VAT)
Steel, white, black	266,-	319,-
Brass	333,-	399,-





# Snowball table

P. 45



Snowball table steel  
– Item no. 710



Snowball table white  
– Item no. 711



Snowball table brass  
– Item no. 712



Snowball table black  
Item no. 713

**Product type:** Table lamp

**Design:** Trond Svendgård, 2005

**Body material:** Steel and aluminium or brass

**Body colour:** Steel, white, brass or black

**Shade material:** Mouth blown glass

**Shade colour:** Opal white matt

**Wire (with dimmer switch):** Transparent (steel and white versions), black (black and brass versions), 180 cm

**Bulb:** G9, Max. 6 W LED only (dimmable)

**Voltage:** 220V - 240V - 50/60Hz

**Net weight:** 0.9 kg

**Minimum order size:** 2

**Spare part available:** Glass shade, dimmer switch

## Dimensions and light direction:

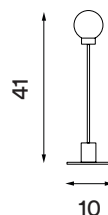

## Recommended dimmable bulb:

 LED – 3 W

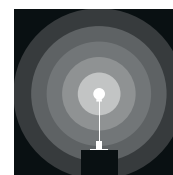

Prices NOK	(RRP ex. VAT)	(RRP incl. VAT)
Steel, white, black	1 992,-	2 490,-
Brass	2 392,-	2 990,-

Prices DKK	(RRP ex. VAT)	(RRP incl. VAT)
Steel, white, black	1 592,-	1 990,-
Brass	1 912,-	2 390,-

Prices SEK	(RRP ex. VAT)	(RRP incl. VAT)
Steel, white, black	2 152,-	2 690,-
Brass	2 632,-	3 290,-

Prices Euro	(RRP ex. VAT)	(RRP incl. VAT)
Steel, white, black	224,-	269,-
Brass	266,-	319,-



# Tradition pendant

P. 46



Tradition pendant tall  
– Item no. 740



Tradition pendant large oval  
– Item no. 741



Tradition pendant small  
– Item no. 742

**Product type:** Pendant lamp series

**Design:** Morten & Jonas, 2022

**Shade material:** Knitted polyester textile, steel

**Shade colour:** Off-white

**Wire:** White silk, 370 cm

**Bulb:** E27, Max. 13 W LED only

**Voltage:** 220V - 240V - 50/60Hz

**Net weight tall:** 3.3 kg

**Net weight large oval:** 4.0 kg

**Net weight small:** 2.8 kg

**Minimum order size:** 1

## Dimensions and light direction:

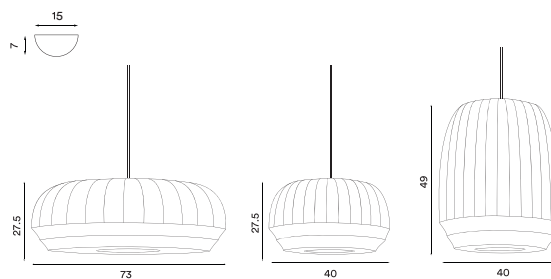

## Recommended bulb:



Prices NOK	(RRP ex. VAT)	(RRP incl. VAT)
Small	3 192,-	3 990,-
Tall	3 752,-	4 690,-
Large oval	4 392,-	5 490,-

Prices DKK	(RRP ex. VAT)	(RRP incl. VAT)
Small	2 632,-	3 290,-
Tall	3 032,-	3 790,-
Large oval	3 592,-	4 490,-

Prices SEK	(RRP ex. VAT)	(RRP incl. VAT)
Small	3 512,-	4 390,-
Tall	4 072,-	5 090,-
Large oval	4 792,-	5 990,-

Prices Euro	(RRP ex. VAT)	(RRP incl. VAT)
Small	358,-	429,-
Tall	416,-	499,-
Large oval	499,-	599,-



# Unika pendant

P. 47



Unika small transparent  
– Item no. 530



Unika small grey  
– Item no. 535



Unika small white  
– Item no. 532



Unika large transparent  
– Item no. 531



Unika large grey  
– Item no. 536



Unika large white  
– Item no. 533

**Product type:** Pendant lamp

**Design:** Anne Louise Due de Fønss  
& Anders Lundqvist, 2012

**Shade material:** Mouth blown glass

**Shade colour:** Transparent, grey or opal white

**Body material:** Brass

**Wire:** Twisted fabric wire (black on transparent and grey versions, white on white version), 370 cm

**Bulb:** E14, Max. 60 W

**Voltage:** 220V - 240V - 50/60Hz

**Net weight:** 0.7 kg (small), 1.0 kg (large)

**Minimum order size:** 2

**Spare parts available:** Brass side screw,  
cord grip canopy

## Dimensions and light direction:

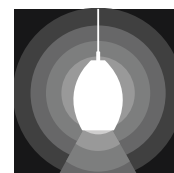
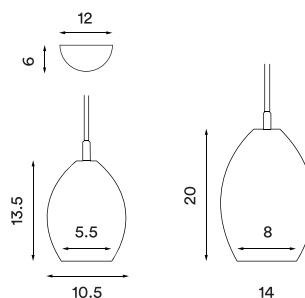

## Recommended bulb:

LED – 3 W



Prices NOK	(RRP ex. VAT)	(RRP incl. VAT)	Prices SEK	(RRP ex. VAT)	(RRP incl. VAT)
Small	2 392,-	2 990,-	Small	2 632,-	3 290,-
Large	2 712,-	3 390,-	Large	3 032,-	3 790,-
Prices DKK	(RRP ex. VAT)	(RRP incl. VAT)	Prices Euro	(RRP ex. VAT)	(RRP incl. VAT)
Small	1 912,-	2 390,-	Small	274,-	329,-
Large	2 232,-	2 790,-	Large	299,-	359,-



# Spare parts

P. 48

Product name	Item no.	NOK RRP ex. VAT	NOK RRP incl. VAT	SEK RRP ex. VAT	SEK RRP incl. VAT
Foot dimmer LED (black)	1101	352,-	440,-	392,-	490,-
Hand dimmer LED (black or transparent)	1111, 1113	352,-	440,-	392,-	490,-
Oslo Wood bulb holder (black)	1001	280,-	350,-	312,-	390,-
Diva glass shade	1004	440,-	550,-	472,-	590,-
Snowball glass shade (D22/70)	1005	336,-	420,-	360,-	450,-
Snowball glass shade (D22/80)	1006	336,-	420,-	360,-	450,-
Moo bulb LED horn 5.5W (E14)	1007	312,-	390,-	360,-	450,-
Moo bulb LED head 7W (E27)	1008	336,-	420,-	360,-	450,-
Cord grip canopy matt (black or white metal)	1021, 1022	176,-	220,-	192,-	240,-
Acorn ceiling canopy matt (white, grey or black)	1054, 1055, 1056	399,-	499,-	412,-	515,-
Acorn hanging part matt (white, grey or black)	1057, 1058, 1059	880,-	1 100,-	976,-	1 220,-
Balancer glass shade	1024	712,-	890,-	792,-	990,-
Over Me D20 glass shade	1035	960,-	1 200,-	1 040,-	1 300,-
Over Me D30 glass shade	1025	1 040,-	1 300,-	1 112,-	1 390,-
Over Me D40 glass shade	1026	1 320,-	1 650,-	1 432,-	1 790,-
Over Me D50 glass shade	1036	1 920,-	2 400,-	2 040,-	2 550,-
Dahl large glass shade	444	2 232,-	2 790,-	2 472,-	3 090,-
Dahl small glass shade	495	1 752,-	2 190,-	1 912,-	2 390,-

# Spare parts

P. 49

Product name	Item no.	DKK RRP ex. VAT	DKK RRP incl. VAT	Euro RRP ex. VAT	Euro RRP incl. VAT
Foot dimmer LED (black)	1101	280,-	350,-	41,-	49,-
Hand dimmer LED (black or transparent)	1111, 1113	280,-	350,-	41,-	49,-
Oslo Wood bulb holder (black)	1001	224,-	280,-	35,-	40,-
Diva glass shade	1004	360,-	450,-	50,-	60,-
Snowball glass shade (D22/70)	1005	280,-	350,-	38,-	45,-
Snowball glass shade (D22/80)	1006	280,-	350,-	38,-	45,-
Moo bulb LED horn 5.5 W (E14)	1007	256,-	320,-	33,-	40,-
Moo bulb LED head 7 W (E27)	1008	264,-	330,-	38,-	45,-
Cord grip canopy matt (black or white metal)	1021, 1022	144,-	180,-	20,-	24,-
Acorn ceiling canopy matt (white, grey or black)	1054, 1055, 1056	340,-	425,-	47,-	56,-
Acorn hanging part matt (white, grey or black)	1057, 1058, 1059	712,-	890,-	99,-	119,-
Balancer glass shade	1024	600,-	750,-	83,-	99,-
Over Me D20 glass shade	1035	800,-	1 000,-	108,-	129,-
Over Me D30 glass shade	1025	872,-	1 090,-	116,-	139,-
Over Me D40 glass shade	1026	1 112,-	1 390,-	149,-	179,-
Over Me D50 glass shade	1036	1 520,-	1 900,-	216,-	259,-
Dahl large glass shade	444	1 752,-	2 190,-	249,-	299,-
Dahl small glass shade	495	1 432,-	1 790,-	199,-	239,-



# General Terms and Conditions

## **Purpose and Definition**

These Terms and Conditions define the collaboration between the Seller Northern.no AS, hereinafter referred to in this document as “Northern”, and the Reseller. These Terms and Conditions take precedent over any oral or written agreement, quote, order confirmation, or invoice.

The term Reseller is used in this document to describe a company which buys products from Northern with the purpose of reselling them to a Customer. Any Reseller must obtain written permission to sell Northern’s products. These Terms and Conditions define the Reseller’s non-exclusive rights to sell Northern’s products in a limited geographical area as agreed with Northern. In addition, a written confirmation must be issued by Northern specifying the right to sell Northern’s products online. Resellers offering Northern’s products online are regulated by additional Terms and Conditions for e-commerce as specified in this document.

The term Customer used in this document is intended to describe a person or company purchasing Northern’s products from the Reseller.

The terms “product”, “item” or “goods” used in this document refer to Northern’s Stock Keeping Units (SKU). SKUs refer to a certain product number in Northern’s Price List.

Northern’s current official Price List is the Recommended Retail Price List published on Northern’s website, [www.northern.no](http://www.northern.no), hereafter referred to as Northern’s Price List.

## **Commercial Restrictions**

Northern is a high-end design brand which requires all Resellers to present the brand and our products in accordance with high standards of similar high-end design brands. Northern will continuously assess the Reseller both qualitatively and quantitatively to evaluate and determine the Reseller’s continued right to represent the brand and sell Northern’s products.

The Reseller’s business must always be conducted in a highly professional manner. The Reseller shall comply with all applicable laws, rules and regulations of government and other bodies, both nationally and internationally, including

classifications requirements, laws, rules and any other regulations or policies which apply in the location where the sales, services and operational work is performed by the Reseller. The Reseller shall ensure that subcontractors and employed personnel adhere to the same strict legal adherence and these same terms & conditions set by Northern when relevant and applicable.

Northern reserves the right to define which of its products categories the Reseller may exhibit, promote, and resell. A Reseller must obtain a written confirmation from Northern to sell categories as specified by Northern.

The Reseller has the right to sell only the products listed in Northern's Price List. Northern reserves the right to discontinue products at any point in time. See Northern's website for reference.

The Reseller can purchase products only from Northern directly, via a licensed agent, or from a licensed distributor, depending on Northern's market-specific setup. Contact Northern for further information about each market.

The Reseller has no right to act in Northern's name, nor to enter into any agreements with any third party on Northern's behalf.

#### **International distribution**

The Reseller can actively promote and resell Northern's products internationally only as agreed with Northern in writing, and only from the country where the Reseller's legal entity is officially registered. Resellers are not allowed to actively promote and resell Northern's products in markets serviced by exclusive distributors. Resellers are not allowed to promote or resell Northern's products to countries or regions which require certification, import documentation, or local governmental approvals not provided as standard by Northern and specified on the Northern website, nor to countries or regions which adhere to other technical standards than the standards offered by Northern and specified on the Northern website. The Northern standard products are CE approved only and can only be sold in countries which accept this standard. If any Northern items are promoted, resold, or distributed elsewhere, it will be at the Reseller's sole risk and liability.

If the Reseller maintains subsidiaries, or establishes or acquire separate legal entities in other countries than the country where the Reseller's legal entity is officially registered, including third party sub-contractors, these new entities have to be separately approved as a Reseller in writing by Northern before any exhibit, promotion, or resale of Northern's products may occur. Northern withholds the full right to refuse to accept trade with such entities.



**The Reseller's Obligations**

The Reseller is required to set an annual sales target in cooperation with Northern describing the minimum annual sales required to uphold the Reseller's right to sell Northern's products under the current agreement the Reseller has with Northern.

The Reseller is obligated to actively promote and sell Northern's products at the Reseller's own expense. Northern's brand and products must always be presented and displayed as a high-end design brand, and communicated correctly to Customers in accordance with the latest versions of the Northern brand and product data available, which is published on Northern's website, [www.northern.no](http://www.northern.no), with updated information about key features such as product information, technical specifications, price, designer, images, and all other relevant data as published by Northern.

The Reseller is furthermore required to utilize the most recent brand and marketing material published by Northern for any type of promotion. All translations, or reproduction, or edits and adjustments to any official material published by Northern must be pre-approved by Northern before publication or exhibition of such material.

The Reseller is required to utilize relevant content provided by Northern to the extent it is relevant to the Reseller's purposes. The Reseller is encouraged to actively use Northern's campaigns as specified in Northern's Campaign Plan as published on Northern's website, [www.northern.no](http://www.northern.no).

Northern requires all Resellers to retain adequate and updated knowledge about the Northern brand and products in order to present the brand to Customers in accordance with the available brand and product information, as well as the marketing and sales material, the communication tone and the values of the brand. Furthermore, the Reseller is obligated to ensure that all employees and representatives of the Reseller have completed adequate training and adhere to the brand and product information.

For the purposes of good customer relations and a close cooperation dialogue, adequate service ability and optimal operational production planning, the Reseller is expected to have close ongoing communication with Northern about any commercial projects that may involve products from Northern.

The Reseller is expected to inform Northern about any significant changes in operations, company ownership structure, management, staffing capacity or financial situation and risk without any further delay.

In case of product recalls, and to secure good processes related to any quality related issues, the Reseller is obligated to keep an updated and complete register of stocked and sold items, and will be expected to support Northern in solving any quality related issues all the way to the end Customers if needed.

See also the “Order and order confirmation” section for further operative obligations related to the order process.

### **Order and Order Confirmation**

The Reseller is obligated to purchase SKUs following Northern’s minimum order sizes as described in Northern’s Price List. The minimum order size describes the number of the SKUs contained in an outer box. Any purchase order stating an amount less than the minimum order size will automatically be rounded up to the closest multiple of the minimum order size of the SKU, or alternatively a Split Fee will be added if a split is indeed required by the Reseller. Please refer to Northern’s Shipping Terms and Conditions for current fees.

Once an order is placed by the Reseller, an order confirmation will be sent to the Reseller no later than two (2) working days after receiving the order in writing. The order confirmation includes item specification, price, name of the Reseller, payment terms, delivery terms, delivery address and pick-up /delivery date. No order is valid until the written order confirmation is issued by Northern. Any date indicated on any order confirmation is to be considered as an estimate only, and Northern has no liability related to any change in the indicated delivery dates.

The Reseller is responsible for verifying all order confirmations issued by Northern and must inform Northern of any changes to the order, or errors in the order confirmation, within one (1) working day after receiving the order confirmation, otherwise the order will be effectuated. Specific shipping terms vary depending on which country the order is related to. See Northern’s Shipping Terms & Conditions for further details.

The Reseller is obligated to inform Northern without any delay if changes occur to any relevant company data, such as company name, registration number, contact details, shipping or payment addresses.

A quotation (“Quote”) is a description of the price offer for a specified product for a specific Reseller for a limited period. A quotation does not involve any reservation of stock. Northern must receive a written purchase order from the Reseller after a quotation is issued before an order confirmation is issued by Northern and any responsibility for Northern to deliver products comes into action. Any quotation given by Northern requires that the Reseller relays the quotation to the Customer without any amendment or change to its content. Northern is not responsible for any amendment or change the Reseller has made to a quotation.

### **Price**

The price of Northern’s products follow the current Price List at any time. Note that all prices are periodically subject to change, normally on September 1<sup>st</sup> every year. Discounts and discount levels for permanent distribution agreements follow the

individual contract with the Reseller, unless otherwise agreed upon in writing. Unless otherwise stated, all net prices to the Reseller in any quotation or order confirmation are exclusive of shipping and insurance, and exclusive of VAT. The Reseller can only place orders in the currency selected by Northern for that Reseller.

Where no net price has been quoted, or a quoted price is no longer valid, or errors have been made in the quotation or order confirmation, the price listed in Northern's Price List at the time of the order acceptance date will be the valid price of the product, unless a valid distribution agreement states otherwise.

### **Cancellation and return of goods**

No confirmed order by Northern can be cancelled by the Reseller without a written approval from Northern. If no written approval of order cancellation is issued by Northern, the Reseller is accountable for the order and shall indemnify Northern in full against all losses (such as order value, indirect costs, other charges and expenses incurred) as a result of any such cancellation, even if products are not yet delivered.

No product can be returned to Northern without a written agreement with Northern. Any product returned by the Reseller without prior confirmation from Northern, and through no fault of Northern's, will be subject to billing of all related losses (such as order value, indirect costs, damages, other charges and expenses incurred). Returned goods by postal claim to Northern or its local sales representative will not be collected or paid for by Northern.

Product items made specifically for each client, defined and marked by Northern as Made-to-order items in Northern's Price List, as well as any customized items, may not be cancelled or returned under any circumstance.

### **Payment terms**

All orders, unless otherwise agreed upon in writing between the Reseller and Northern in advance, are subject to prepayment prior to delivery.

Credit may be granted for Resellers with approved credit evaluation, repetitive order placement, and a solid and proven track record and cooperation history in certain markets. In case of planned or initiated ownership changes, and/or other significant changes to the Resellers' financial situation and risk that may affect Northern, the Reseller should immediately and without any further delay inform Northern about these changes for a renewed credit evaluation. Northern holds the right to withdraw any credit agreement at any point in time without further notice.

Invoices from Northern must be paid no later than the due date specified on the invoice. Exceptions shall always be approved in writing by Northern in advance if any further credit extension is to be granted under exceptional circumstances.

In case of late payment, reminder fees and interest related to outstanding payments will be added to the original invoice value. Specific charges and interests vary, and further charges and interests will depend on the fees applied by Northern's external partners, such as invoicing, factoring, and debt collection agencies. Unpaid invoices will ultimately be transferred to a debt collecting agency if the invoice remains unpaid without any further notice.

**Delivery terms**

Ex Works shipping is the default shipping method for all orders received by Northern. For selected resellers in certain markets Northern offers to ship goods to Resellers against payment for transportation. Details about shipping terms for each market are stated in Northern's Shipping Terms & Conditions relevant for the market in question.

The order confirmation from Northern specifies which delivery terms apply for each specific order.

All warehousing and handling costs related to delays to planned shipping caused by the Reseller, and/or related to items not being picked up according to agreed deadlines at the Northern warehouses or factories will be charged in full to the Reseller.

If or when Northern offers to ship goods to its Reseller against payment of transportation, the delivery of goods will be to the place and address specified in the order confirmation issued from Northern, with delivery information including date and time as specified therein. Unless otherwise instructed in writing, Northern will ship by the method of Northern's choosing. The payment for cost of transport will be added to the invoice based on Northern's Shipping Terms & Conditions.

Additional fees may incur if the Reseller or the Reseller's Customer require additional documentation or services other than the standard Northern Order Confirmation, such as, but not limited to, custom packaging or labelling data, or other formats that are not standard to Northern, or export documents, such as Country of Origin documentation.

For DAP deliveries, the Reseller is obligated to inform Northern of any restrictions, limitations, or alterations in delivery hours during the day, week and year related to any order, as well as other known restrictions in terms of admission, access or transportation hinderances for a large vehicles etc. to the physical location where the delivery is to be made. Northern delivers within standard opening hours in accordance with specific policies and services as specified by the selected carrier. For deliveries not in accordance with the standard services as specified by the selected carrier charges will apply.

Note that products not marked with “made-to-order” in Northern’s Price List will commonly be in stock. Stocked items can be sold out periodically, and the Reseller is therefore required to contact Northern for the latest updates on the current stock situation for the products in question, and should always receive an order confirmation from Northern before making any binding offers to its Customer.

Estimated delivery time for items marked as “made-to-order” in Northern’s Price List is specified on the order confirmation issued by Northern.

Note that there might be longer delivery time than specified in the order confirmation in seasons of high demand or during vacation periods, or if there are delaying reasons beyond our control such as supplier break downs, material shortages, or force majeure.

Any dates specified by Northern in any quotation or order confirmation are intended as an estimate only. Under no circumstances shall Northern be held responsible or liable for any loss or damage of any kind caused by any delay in the supply of the goods or services, unless otherwise has been agreed specifically in writing in beforehand of an order confirmation. Any liability Northern has for non-delivery of goods shall be limited to delivering or replacing the missing or damaged goods within 6 months, or alternatively Northern retains the right to issue a credit note against any invoice value for these products in such situations.

No products are sent from Northern to any domestic households on behalf of the Reseller or any Customer.

### **Guarantee**

A standard production guarantee of one (1) year applies to all products from Northern, unless local laws, regulations, or specific agreements regarding particular orders stipulate otherwise.

Warranty conditions apply only to standard products that have not been reworked or modified by the user, the Customer, or the Reseller.

### **Claims**

For visible damages, defects, or incorrect type or quantity identified on arrival, the Reseller is responsible for obtaining a signed damage declaration / deviation report from the transporter for the claim to take effect. Such deviations must also be reported to Northern no later than two – 2 – working days after delivery together with a copy of the signed transporter damage declaration.

Product errors must be reported immediately after they are identified by the Reseller or the Customer. A standard format supplied by Northern for claims reporting applies to all claims. Photos, damage description and product batch information must always be included in the claims reporting to Northern. Local consumer laws regulating warranty and claims may apply.

Northern or its local sales representative has the right to inspect any product subject to claims or deviations, including transportation damages. Northern or its local sales representative has the right to conduct any reasonable actions to repair items, or reduce the scope or cost of damage, or potential replacement. No product can be disposed of, or returned to Northern, unless specifically agreed upon in writing between the parties.

Northern is not responsible for any damage or defect caused by the Reseller or Customer after the item is delivered from Northern, including damages or defects caused in storage, transportation, display, or handling.

Repairs or any modification to a product performed by the Reseller or the Customer will not be compensated for unless this has been specifically agreed upon in writing by Northern prior to execution.

Claims or deviation compensation from Northern to the Reseller is limited to the product value, and further limited to situations related to product error, correction of erroneously delivered goods, and/or delivery of an erroneous product, or lack of delivery. Indirect damages, for example costs or loss associated with the Reseller's product handling, sales, or distribution etc., are not subject to any compensation, claim or payment between the parties. Further, any third-party damages, costs, or loss, are not subject to any claim or payment between the parties.

### **Restrictions**

None of the parties have the authority to act on the other party's behalf, nor to engage in any commitment toward any third party on the other's behalf.

Northern has the right to change construction, materials, weight, and any other measurements of products without any prior notice, as long as this does not significantly change the product. The Northern website is the point of reference for any correct updated and valid product specifications.

Northern shall have no liability towards the Reseller for any failure to deliver the goods or any delay in doing so or for any damage or defect to the goods delivered that is caused by an event or circumstance beyond Northern's reasonable control (force majeure), including, without limitation, strikes, lock-outs and other industrial disputes, breakdown of systems or network access, flood, fire, explosion, death or accidents. Furthermore, Northern has no liability for products not correctly

assembled according to the Northern User Manuals, or in violation of any applicable laws or standards.

The goods are manufactured and sold in accordance with the EC directives, declaring that the goods comply with the essential health and safety requirements for the European market, furthermore they are CE approved and are CE labelled. No other local, national, or regional approval or conformity standard is provided by Northern unless agreed to in writing, and the Reseller should renounce distribution or use of the goods as sold where other approval or standard may be required. Any such distribution or use is the sole responsibility of the Reseller, and any legal dispute or claim thereof from any third party should be directed towards and handled by the Reseller.

Northern is not responsible for any information, advice, or any recommendations given by our sales representatives, staff, retailers or our other partners and affiliates to the Reseller unless they are confirmed in writing by Northern. If acted upon, this is entirely at the Reseller's own risk, and accordingly, Northern shall not be liable for any such information, advice, or recommendation.

Any typographical, clerical or otherwise, error or omission in any official Northern sales literature, quotation, Price List, acceptance of offer, invoice, or any other document or information issued by Northern shall be subject to ongoing correction without any liability on the part of Northern.

All images, renderings, and descriptions of products, including colours and materials presented by Northern on any of its platforms are indicative. Variations in colours and material nuances naturally vary over time and in use.

### **Rights protection**

Products from Northern, including any drawings, specifications, product or material design elements, patents, trademarks, market related material and/or know-how are owned by Northern, and shall remain Northern's property, throughout and after termination of the business relationship between Northern and the Reseller.

### **Confidentiality**

The parties may not under any circumstance distribute or reveal matters of vital interest or any confidential information to a third party during or after the business relationship between Northern and the Reseller.

### **Disputes**

This contract shall be governed by, and interpreted, in accordance with Norwegian law and the Norwegian courts shall have jurisdiction to resolve any disputes between Northern and the Reseller.

Any legal disputes between the parties should be solved through direct negotiations. If direct negotiations do not solve the dispute, legal mediators, Norwegian law, and the Norwegian courts may be used.

\*\*\*

## Additional Terms and Conditions for e-Commerce

Unless otherwise expressly agreed in writing, all sales are subject to the following Terms and Conditions specific to online sales, in addition to the above General Terms and Conditions. Notwithstanding any other provision of the contract, nothing in the contract confers or purports to confer any right to enforce any of its terms on any person or third party who is not a party to it.

### **Obligations of the Reseller**

The Reseller cannot promote or resell Northern's products on any other website than the official Reseller website approved by Northern. Any website for the distribution of Northern's products must be approved by Northern prior to launching. The Reseller cannot promote or resell Northern's products on any third-party online store such as eBay, Amazon, or the like.

Northern expects the Reseller to sustain the same level of brand knowledge, product knowledge, technical knowledge, after service competencies, and to provide the same level of service towards the Customer, as one can expect from any physical Northern retailer or distribution partner.

The functionality on the Reseller's website must be at a satisfactory level compared to the industry standard, or other relevant benchmarks. The domain name must correspond to the Resellers brand name so that the Customer can easily identify that the Reseller is the brand owner of the website.

The Resellers' website domain name or company name cannot solely contain the word "Northern" or any Northern product name, such as "Acorn". However, the Reseller can maintain a subdomain branded as a specific Northern subdomain or Northern product domain of the Reseller's website if it is approved by Northern in writing. Any product names of Northern's products are the property of Northern alone. The Reseller cannot use these names in a way that it can look like they belong to the Reseller and the name should always be displayed together with and in



conjunction to the Northern brand name and brand logo. Examples of such names are: Acorn, Buddy, Oaki, etc.

The Reseller must continually update websites with the most recent Northern logo and brand name, all relevant marketing material, product information, prices, product images and product names, reflecting the current product names, product description and technical specifications and an updated presentation of the overall product portfolio.

The Reseller can only display official brand and product images that are supplied by Northern, unless otherwise has been agreed in writing. All materials not provided by Northern should be approved by Northern prior to publishing on the Resellers' website.

Any question or comment from Customers related to Northern or our products on the Resellers' website must be replied to correctly and in a timely fashion by the Reseller.

Without compromising the Resellers' right to set their own prices, the Reseller cannot present the discount on the product as the main online content. The quality and design of the Northern brand and products shall be the main content in the online presentation and marketing of Northern products. The Reseller is responsible to comply with any legal requirements, data protection laws, e-commerce laws, and any other current legal requirements protecting the Customer. The Reseller is responsible for protecting the Customers online payment in a way that complies with current online payment security standards.

All market communication, including all claims handling or after sales communication with the Customer, shall be handled by the Reseller only and not by Northern. Transportation of goods, including transport prices, choice of transport price models, delivery information, and information about delays towards the Customer is solely a matter between the Reseller and the Customer.

Minimum quantities apply for the ordering of certain SKUs – see Northern's Price List for further details. SKUs not kept in stock by the Reseller should not be sold as "available on demand" and should be clearly presented as a non-stock item or listed with the appropriate expected delivery time.

\*\*\*

