

vitra.

PRICE LIST 2023

HOME COLLECTION & OFFICE SEATING

SE – EN

A digital price list with a visual product information tool for Sales and Retail.

Quick and easy access to up-to-date product information anytime and anywhere.

Start using pCon.facts



Prices valid from 1st January 2023

Areas of use

Some products are recommended for domestic use only. Such information is noted in the description of materials.

Special requirements and standards apply for furniture that will be subject to intensive usage in public spaces, such as educational institutions, fast food restaurants or event venues. Please ask our sales representatives about the suitability of the respective Vitra product for these kinds of applications before placing an order.

All products in the **Quick Ship** programme are identified in the price list by a lorry symbol. 

Office and conference chairs (swivel)

Chairs

Tables

Desks

Public waiting areas

Lounge chairs and armchairs

Sofas

Coffee and side tables

Stools and benches

Storage and partition elements

Accessories
Living, dining, decorative objects, home office,
clocks, lighting and publications

Quick Ship programme

General terms, conditions
and information



Alphabetical index by product

Price list 2023

K

- 461 Key Ring Hella Jongerius
- 462 Key Ring Sun Alexander Girard

L

- 433 L'Oiseau Ronan & Erwan Bouroullec
- 242 La Chaise Charles & Ray Eames
- 478 Lampe de Bureau Jean Prouvé
- 128 Landi Chair Hans Coray
- 393 Living Tower Verner Panton
- 42 Lobby Chair ES 104 Charles & Ray Eames
- 129 Lobby Chair ES 105, 108 Charles & Ray Eames
- 463 Locker Box Konstantin Grcic
- 234 Lounge Chair & Ottoman Charles & Ray Eames

M

- 464 Magnet Dots Hella Jongerius
- 309 Mariposa Club Armchair Edward Barber & Jay Osgerby
- 310 Mariposa Sofa Edward Barber & Jay Osgerby
- 209 Meda Gate Alberto Meda
- 131 MedaSlim Alberto Meda
- 366 Metal Side Tables Ronan & Erwan Bouroullec
- 438 Metal Wall Relief Alexander Girard
- 451 Miniatures Collection Vitra Design Museum
- 130 Moca Jasper Morrison

N

- 383 Nelson Bench George Nelson
- 370 NesTable Jasper Morrison
- 440 Nuage Ronan & Erwan Bouroullec
- 441 Nuage (céramique) Ronan & Erwan Bouroullec

O

- 465 O-Tidy Michel Charlot
- 371 Occasional Low Table Jasper Morrison
- 372 Occasional Table LTR Charles & Ray Eames
- 133 Organic Chair Charles Eames & Eero Saarinen
- 134 Organic Conference Charles Eames & Eero Saarinen
- 245 Organic Highback Charles Eames & Eero Saarinen

P

- 136 Panton Chair Verner Panton
- 135 Panton Chair Classic Verner Panton
- 137 Panton Junior Verner Panton
- 480 Petite Potence Jean Prouvé
- 251 Petit Repos Antonio Citterio
- 43 Physix Alberto Meda
- 45 Physix Studio Alberto Meda
- 46 Pivot Counter Stool, Pivot High Stool, Pivot Stool Antonio Citterio
- 178 Plate Dining Table Jasper Morrison
- 373 Plate Table Jasper Morrison
- 138 Plywood Group DCM, DCW Charles & Ray Eames
- 139, 243 Plywood Group LCM, Calf's Skin, Leather Charles & Ray Eames
- 140, 244 Plywood Group LCW, Calf's Skin, Leather Charles & Ray Eames
- 442 Plywood Mobile Charles & Ray Eames
- 313 Polder Hella Jongerius
- 479 Potence Jean Prouvé
- 482 Publications Vitra Design Museum

R

- 401 Rayonnage Mural Jean Prouvé
- 467 Repad Ronan & Erwan Bouroullec
- 246 Repos Antonio Citterio
- 250 Repos Ottoman Antonio Citterio
- 443 Resting Animals Front
- 48 Rookie Konstantin Grcic
- 49 Rookie High Konstantin Grcic
- 425 Rotary Tray Jasper Morrison

S

- 466 S-Tidy Michel Charlot
- 411 Seat Dots Hella Jongerius
- 446 Silhouettes Alexander Girard
- 252 Slow Chair & Ottoman Ronan & Erwan Bouroullec
- 307, 422 Sofa Tray Antonio Citterio
- 315 Soft Modular Sofa Jasper Morrison
- 65 Soft Pad Chairs EA 205/207/208 Charles & Ray Eames
- 14, 69 Soft Pad Chairs EA 217/219 Charles & Ray Eames
- 71, 218 Soft Pad Chair EA 222/223 Charles & Ray Eames
- 219 Soft Pad Chaise ES 106 Charles & Ray Eames
- 50, 141 Softshell Chair Ronan & Erwan Bouroullec
- 143 Softshell Side Chair Ronan & Erwan Bouroullec
- 412 Soft Seats
- 192 Soft Wait Edward Barber & Jay Osgerby
- 192 Soft Work Edward Barber & Jay Osgerby
- 144 Standard Jean Prouvé
- 145 Standard SP Jean Prouvé
- 146 Stool-Tool Konstantin Grcic
- 384 Stools Charles & Ray Eames
- 356 Suita Club Armchair Antonio Citterio
- 355 Suita Club Sofa Antonio Citterio
- 352 Suita cushions Antonio Citterio
- 351 Suita Daybed Antonio Citterio
- 351 Suita Ottoman Antonio Citterio
- 322 Suita Sofa Antonio Citterio
- 180 Super Fold Table Jasper Morrison

T

- 184 Table S.A.M. Bois Jean Prouvé
- 385 Tabouret 307 Jean Prouvé
- 386 Tabouret Bois Jean Prouvé
- 147 Tabouret Haut Jean Prouvé
- 387 Tabouret Métallique Jean Prouvé
- 447 Terracotta Pots Thélonius Goupil
- 148 Tip Ton Edward Barber & Jay Osgerby
- 149 Tip Ton RE Edward Barber & Jay Osgerby
- 468 Toolbox Arik Levy
- 185 Trapèze Jean Prouvé
- 423 Trays Jasper Morrison

U

- 51, 150 Unix Chair Antonio Citterio
- 403 Uten.Silo Dorothee Becker

V

- Vases Découpage Ronan & Erwan Bouroullec
- Visiona Stool Verner Panton
- Vlinder Sofa Hella Jongerius

W

- 471 Wall Clocks George Nelson
- 153, 389 Wiggle Side Chair Frank Gehry
- 153, 389 Wiggle Stool Frank Gehry
- 154 Wire Chair DKR, DKR-2, DKR-5, DKR Colours Charles & Ray Eames
- 156 Wire Chair DKW, DKW-2, DKW-5 Charles & Ray Eames
- 157 Wire Chair DKX, DKX-2, DKX-5 Charles & Ray Eames
- 158 Wire Chair LKR, LKR-2, LKR-5, LKR Colours Charles & Ray Eames
- 449 Wooden Dolls Alexander Girard
- 369 Wooden Side Tables Ronan & Erwan Bouroullec

Z

- 473 Zoo Timers George Nelson

Office and conference chairs (swivel)



.04
Maarten Van Severen
7



AC 5 Work
Antonio Citterio
8



AC 5 Studio
Antonio Citterio
10



AC 5 Meet
Antonio Citterio
11



EA 117/118/119
Charles & Ray Eames
12



EA 217/219
Charles & Ray Eames
14



Allstar
Konstantin Grcic
15



AM Chair
Alberto Meda
16



PACC
Charles & Ray Eames
18



PSCC
Charles & Ray Eames
19



Fauteuil Direction Pivotant
Jean Prouvé
21



Grand Executive
Antonio Citterio
22



Grand Conference
Antonio Citterio
23



HAL RE Studio
Jasper Morrison
24



HAL RE Armchair Studio
Jasper Morrison
25



ID Cloud
Antonio Citterio
28



ID Air
Antonio Citterio
30



ID Mesh
Antonio Citterio
32



ID Soft
Antonio Citterio
34



ID Soft L
Antonio Citterio
36



ID Trim
Antonio Citterio
38



ID Trim L
Antonio Citterio
40



Lobby Chair ES 104
Charles & Ray Eames
42



Physix
Alberto Meda
43



Physix Studio
Alberto Meda
45



Pivot Counter Stool
Antonio Citterio
46



Pivot High Stool
Antonio Citterio
46



Pivot Stool
Antonio Citterio
46



Rookie
Konstantin Grcic
48



Rookie High
Konstantin Grcic
49



Softshell Chair
R & E Bouroullec
50



Unix Chair
Antonio Citterio
51



Office and conference chairs (swivel)

Chairs

Tables

Desks

Public waiting areas

Lounge chairs and armchairs

Sofas

Coffee and side tables

Stools and benches

Storage and partition elements

Accessories

Living, dining, decorative objects, home office,
clocks, lighting, publications

Quick Ship programme

General terms, conditions
and information



.04

Maarten Van Severen, 2000



.04



.04 Counter



All measurements are pursuant to EN 1335-1:2000
 More detailed information is found in the chapter 'Explanation of measurements'.

Backrest and seat: flexible backrest with integrated leaf springs. Polyurethane integral foam seat shell with upholstered effect, self-supporting on a steel frame.

Armrests: with or without armrests in integral foam.

Micro-mechanism: rubber ball joint allows multi-directional movement. Height-adjustable.

Base: five-star base and die-cast aluminium bridge, powder-coated. Fitted with castors or with plastic glides for carpet or felt glides for hard floors.

.04	Article no.	without VAT in SEK*	with VAT in SEK*
without armrests	440 420 00		
Base powder-coated in black	55	10.000,00	12.500,00
with armrests	440 421 00		
Base powder-coated in black	55	11.440,00	14.300,00

.04 Counter	Article no.	without VAT in SEK*	with VAT in SEK*
without armrests	440 422 00		
Base powder-coated in black	55	11.760,00	14.700,00
with armrests	440 423 00		
Base powder-coated in black	55	13.680,00	17.100,00

Seat shell	Castors/Glides .04	Castors/Glides .04 Counter
01 basic dark	02 castors hard, braked for carpet	04 glides for carpet
10 bright red	03 castors soft, braked for hard floor	05 felt glides for hard floor
77 dark green	04 glides for carpet	06 castors inversely braked
78 mango	05 felt glides for hard floor	

AC 5 Work

Antonio Citterio, 2017

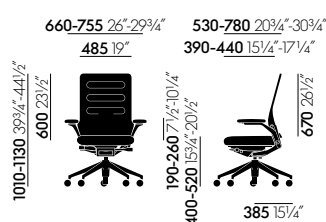

AC 5 Work with FreeFloat armrests and adjustable lumbar support

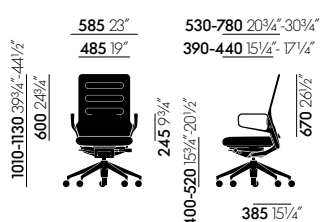

AC 5 Work with ring armrests and adjustable lumbar support

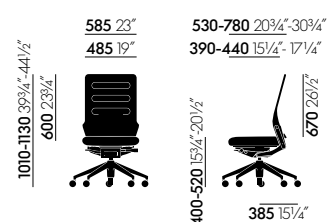

AC 5 Work without armrests, with adjustable lumbar support

All measurements are pursuant to EN 1335-1:2000
More detailed information is found in the chapter 'Explanation of measurements'.

Office swivel chair with FreeFloat armrests in accordance with EN 1335, Ergonomic Seal of Approval.

Seat mechanism: FlowMotion mechanism with synchronised forward tilt (can be disengaged) and with seat depth adjustment. Seat mechanism powder-coated in basic dark.

Backrest and seat: self-supporting backrest structure with horizontally stitched padding. Backrest mount in polished die-cast aluminium. Optional height-adjustable lumbar cushion. Seat cushion in polyurethane foam. Optionally available with contoured seat. Cover in fabric or leather.

Armrests: choice of fixed, polished die-cast aluminium ring armrests for conference areas (optional leather pads are matched to the leather upholstery; for chairs with fabric covers, the leather pads are in the colour nero); or height-adjustable armrests; or FreeFloat armrests with polyurethane pads in basic dark.

Base: five-star polyamide base in basic dark or polished die-cast aluminium base with double castors (Ø 60 mm) in basic dark.

AC 5 Work

Antonio Citterio, 2017

vitra.



AC 5 Work	Article no.	without VAT in SEK*	with VAT in SEK*
without adjustable lumbar support	421 025 00		
Fabric F30		11.080,00	13.850,00
Fabric F60		11.728,00	14.660,00
Leather L20		17.808,00	22.260,00
Leather L50		21.712,00	27.140,00
with adjustable lumbar support	421 026 00		
Fabric F30		11.504,00	14.380,00
Fabric F60		12.152,00	15.190,00
Leather L20		18.232,00	22.790,00
Leather L50		22.136,00	27.670,00
Surcharges armrests			
without armrests	11	0,00	0,00
height-adjustable armrests	12	1.984,00	2.480,00
FreeFloat armrests	13	2.864,00	3.580,00
aluminium ring armrests	14	2.864,00	3.580,00
leather-covered aluminium ring armrests	15	3.640,00	4.550,00
Surcharges seat			
standard	0	0,00	0,00
contour seat	1	616,00	770,00
Surcharges base			
plastic basic dark	0	0,00	0,00
polished aluminium	1	1.592,00	1.990,00

Fabric F30	Fabric F60	Leather L20	Leather L50	Castors
. Plano	. Hopsak . Twill	. Leather	. Leather Premium F	02 castors hard, braked for carpet 03 castors soft, braked for hard floor

AC 5 Studio

Antonio Citterio, 2017

vitra.



All measurements are pursuant to EN 1335-1:2000
More detailed information is found in the chapter 'Explanation of measurements'.

Studio chair (swivel, height-adjustable) in accordance with EN 16139.

Seat mechanism: tilt mechanism, lockable in upright position. Mechanism housing in polished aluminium.

Backrest: self-supporting backrest construction with horizontally stitched padding. Cover in fabric or leather.

Seat: polyurethane foam padding. Cover in fabric or leather.

Armrests: without armrests or with polished die-cast aluminium ring armrests, optional leather pads (pads are matched to the leather upholstery; for chairs with fabric covers, the leather armrest pads are in the colour nero).

Base: five-star base in polished die-cast aluminium or plastic (basic dark) on double castors (Ø 60 mm). Swivel mount, height adjustable.

AC 5 Studio

	Article no.	without VAT in SEK*	with VAT in SEK*
five-star base	421 020 00		
Fabric F30		7.832,00	9.790,00
Fabric F60		8.384,00	10.480,00
Leather L20		14.992,00	18.740,00
Surcharges armrests			
without armrests	11	0,00	0,00
aluminium ring armrests	14	2.224,00	2.780,00
leather-covered aluminium ring armrest	15	3.000,00	3.750,00
Surcharges base			
plastic basic dark	0	0,00	0,00
polished aluminium	1	1.592,00	1.990,00

Fabric F30	Fabric F60	Leather L20	Castors
. Plano	. Hopsak . Twill	. Leather	02 castors hard, braked for carpet 03 castors soft, braked for hard floor

AC 5 Meet

Antonio Citterio, 2017

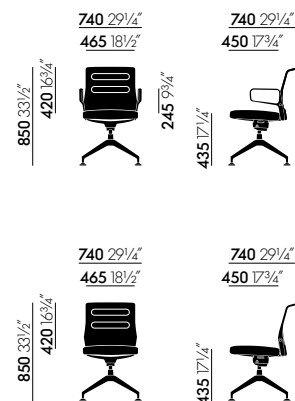

All measurements are pursuant to EN 1335-1:2000
More detailed information is found in the chapter 'Explanation of measurements'.

Conference chair (swivel) in accordance with EN 16139.

Seat mechanism: tilt mechanism, lockable in upright position. Mechanism housing in polished aluminium.

Backrest: self-supporting backrest construction with horizontally stitched padding. Cover in fabric or leather.

Seat: polyurethane foam padding. Cover in fabric or leather.

Armrests: without armrests or with polished die-cast aluminium ring armrests, optional leather pads (pads are matched to the leather upholstery; for chairs with fabric covers, the leather armrest pads are in the colour nero).

Base: four-star base in polished die-cast aluminium on glides. Swivel mount with shock-absorbing seat suspension.

AC 5 Meet

	Article no.	without VAT in SEK*	with VAT in SEK*
four-star base	421 021 00		
Fabric F30		9.424,00	11.780,00
Fabric F60		9.976,00	12.470,00
Leather L20		16.584,00	20.730,00
Surcharges armrests			
without armrests	11	0,00	0,00
aluminium ring armrests	14	2.224,00	2.780,00
leather-covered aluminium ring armrest	15	3.000,00	3.750,00

Fabric F30	Fabric F60	Leather L20	Glides
. Plano	. Hopsak . Twill	. Leather	04 glides for carpet 05 felt glides for hard floor

Aluminium Chairs EA 117/118/119

Charles & Ray Eames, 1958



EA 117



EA 118



EA 119

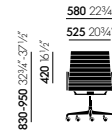

EA 117

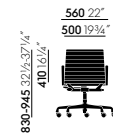

EA 118

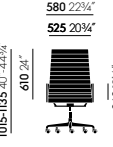

EA 119

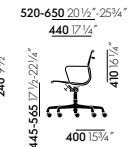

All measurements are pursuant to EN 1335-1:2000
 More detailed information is found in the chapter 'Explanation of measurements'.

Backrest and seat: EA 117 with medium-height backrest; EA 118 with medium-height backrest and table-oriented sitting position; EA 119 with high backrest. High-frequency welded horizontal ribbing in fabric or leather. Side profiles and spreaders in die-cast aluminium, with a polished or chrome-plated finish or powder-coated in deep black.

Seat mechanism: adjustable backward tilt, lockable in the forward position. Continuous seat height adjustment with gas spring.

Armrests: die-cast aluminium, with a polished or chrome-plated finish or powder-coated in deep black.

Base: five-star base in die-cast aluminium, with a polished or chrome-plated finish or powder-coated in deep black. Equipped with hard castors for carpet or soft castors for hard floors. Castor covers in black for polished and black base, with chrome-plated finish for chrome base.

Aluminium Chairs EA 117/118/119

Charles & Ray Eames, 1958

vitra.



EA 117	Article no.	without VAT in SEK*	with VAT in SEK*
medium-high backrest, swivel	412 364 00		
with armrests			
Fabric F60		26.080,00	32.600,00
Leather L20		32.400,00	40.500,00
Leather L50		37.200,00	46.500,00
Surcharges base			
polished	1	0,00	0,00
powder-coated in deep black	4	0,00	0,00
chromed	0	2.032,00	2.540,00

EA 118	Article no.	without VAT in SEK*	with VAT in SEK*
medium-high backrest, swivel	412 329 00		
with armrests			
Fabric F60		23.680,00	29.600,00
Leather L20		29.360,00	36.700,00
Leather L50		34.000,00	42.500,00
Surcharges base			
polished	1	0,00	0,00
powder-coated in deep black	4	0,00	0,00
chromed	0	2.032,00	2.540,00

EA 119	Article no.	without VAT in SEK*	with VAT in SEK*
high backrest, swivel	412 365 00		
with armrests			
Fabric F60		31.840,00	39.800,00
Leather L20		38.960,00	48.700,00
Leather L50		44.320,00	55.400,00
Surcharges base			
polished	1	0,00	0,00
powder-coated in deep black	4	0,00	0,00
chromed	0	2.920,00	3.650,00

Fabric F60	Leather L20	Leather L50	Castors
. Hopsak	. Leather/back panel Plano	. Leather Premium F/back panel Plano	02 castors hard, braked for carpet 03 castors soft, braked for hard floor

Soft Pad Chairs EA 217/219

Charles & Ray Eames, 1969

vitra.



EA 217



EA 219

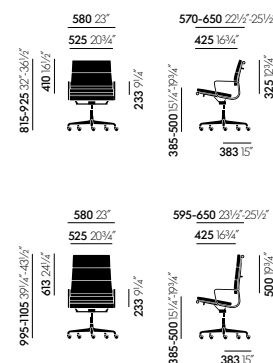

All measurements are pursuant to EN 1335-1:2000
 More detailed information is found in the chapter 'Explanation of measurements'.

Backrest and seat: EA 217 with medium-high backrest, EA 219 with high backrest. Sewn-on cushions with polyurethane foam upholstery in leather. Side profiles and spreaders in die-cast aluminium, with a polished or chrome-plated finish or powder-coated in deep black.

Seat mechanism: adjustable backward tilt, lockable in the forward position. Continuous seat height adjustment with gas spring.

Armrests: die-cast aluminium, with a polished or chrome-plated finish or powder-coated in deep black.

Base: five-star base in die-cast aluminium, with a polished or chrome-plated finish or powder-coated in deep black. Equipped with hard castors for carpet or soft castors for hard floors. Castor covers in black for polished and black powder-coated base, with chrome-plated finish for chrome base.

EA 217	Article no.	without VAT in SEK*	with VAT in SEK*
medium-high backrest, swivel	412 381 00		
with armrests			
Leather L20		34.400,00	43.000,00
Leather L50		40.240,00	50.300,00
Surcharges base			
polished	1	0,00	0,00
powder-coated in deep black	4	0,00	0,00
chromed	0	2.032,00	2.540,00

EA 219	Article no.	without VAT in SEK*	with VAT in SEK*
high backrest, swivel	412 382 00		
with armrests			
Leather L20		42.080,00	52.600,00
Leather L50		49.600,00	62.000,00
Surcharges base			
polished	1	0,00	0,00
powder-coated in deep black	4	0,00	0,00
chromed	0	2.920,00	3.650,00

Leather L20

Leather/back panel Plano

Leather L50

Leather Premium F (contrast seam)/back panel Plano

Castors

02 castors hard, braked for carpet
 03 castors soft, braked for hard floor

Allstar

Konstantin Grcic, 2014



All measurements are pursuant to EN 1335-1:2000
 More detailed information is found in the chapter 'Explanation of measurements'.

Office swivel chair in accordance with EN 1335.

Backrest and seat: backrest in polyamide, coated with polyurethane foam. Backrest height adjustable up to 5 cm using a quick release lever. Seat with contouring on the front edge, consisting of a polyamide seat plate and polyurethane foam. Covers in fabric or leather, freely stretched over the surfaces of the seat and backrest.

Armrest/back bracket: loop frame made of polyamide that simultaneously serves as the armrest structure, backrest support and extended arm of the mechanical unit.

Mechanical unit: the synchronised mechanism can be locked in the upright position. Equipped as standard with seat height and seat depth adjustment. Plastic in the colour deep black.

Base: five-star base in polyamide (deep black) with double castors (Ø 60 mm, basic dark).

Allstar	Article no.	without VAT in SEK*	with VAT in SEK*
Allstar	419 001 00		
Silk Mesh		8.256,00	10.320,00
Fabric F60		9.040,00	11.300,00
Fabric F80		9.336,00	11.670,00
Leather L20		12.192,00	15.240,00

Fabric F60	Fabric F80	Leather L20	Technical textile	Armrests/back bracket	Castors
. Hopsak . Volo	. Tress	. Leather	. Silk Mesh	04 white 12 deep black	02 castors hard, braked for carpet 03 castors soft, braked for hard floor

AM Chair

Alberto Meda, 2016

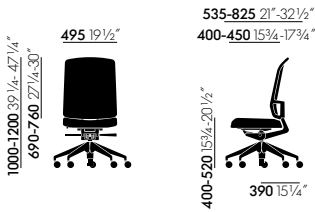

AM Chair without armrests

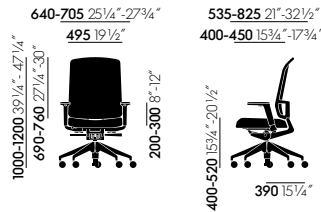

AM Chair with 2D armrests

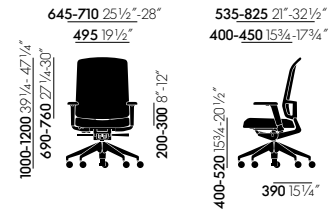

AM Chair with 3D armrests

All measurements are pursuant to EN 1335-1:2000
 More detailed information is found in the chapter 'Explanation of measurements'.

Office swivel chair in accordance with EN 1335, Ergonomic Seal of Approval (LGA Nuremberg).

Seat mechanism: ProMotion mechanism, lockable in upright position. Synchronised mechanism with automatic weight adjustment and manual fine tuning of backrest resistance via 180° rotation. Equipped as standard with seat height and seat depth adjustment. Optionally available with or without spontaneous forward tilt (can be disengaged).

Seat: seat plate made of polyamide; contoured seat cushion made of polyurethane foam; fabric cover.

Back: mesh backrest in LightNet, stretched over frame; fabric backrest in Plano (reverse side in Verso fabric, colour sierra grey). Polyamide backrest frame in deep black. Height-adjustable backrest as a standard feature.

Armrests: 2D armrests with adjustable height and width or 3D armrests with adjustable height, width and depth. Armrest supports in polyamide with polyurethane pads, both in deep black.

Base: five-star base in polyamide (deep black) or in powder-coated aluminium (deep black). Equipped with double castors (Ø 60 mm).

AM Chair

Alberto Meda, 2016

vitra.



AM Chair	Article no.	without VAT in SEK*	with VAT in SEK*
with mesh backrest	417 050 00		
Seat fabric F30, backrest LightNet		6.712,00	8.390,00
with fabric backrest	417 055 00		
Seat fabric F30, backrest fabric (front F30 / back Verso)		7.808,00	9.760,00
Surcharges armrests			
without armrests	00	0,00	0,00
2D armrests	11	1.288,00	1.610,00
3D armrests	12	2.000,00	2.500,00
Surcharges mechanical elements			
ProMotion without forward tilt, with seat depth adjustment	31	0,00	0,00
ProMotion with forward tilt, with seat depth adjustment	32	560,00	700,00
Surcharges base			
plastic, deep black	21	0,00	0,00
aluminium powder-coated in deep black	22	1.504,00	1.880,00

Quickship

AM Chair, seat cover in Plano nero, back cover in LightNet black	Article no.	without VAT in SEK*	with VAT in SEK*
Hard braked castors for carpet	QS1 705 0A	8.000,00	10.000,00
ProMotion mechanism with seat depth adjustment, no forward tilt, armrests and back frame in deep black, 2D-armrests, plastic base in deep black			
Soft braked castors for hard floors	QS1 705 0B	8.000,00	10.000,00
ProMotion mechanism with seat depth adjustment, no forward tilt, armrests and back frame in deep black, 2D-armrests, plastic base in deep black			

Fabric F30

Plano

Netweave backrest LightNet

01 black
02 sierra grey
03 white

Armrests/back brace

12 deep black

Castors

02 castors hard, braked for carpet
03 castors soft, braked for hard floor

Eames Plastic Armchair PACC

Charles & Ray Eames, 1950

vitra.

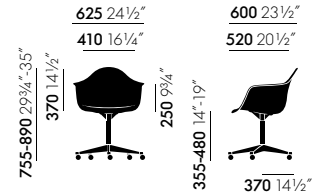

All measurements are pursuant to EN 1335-1:2000
More detailed information is found in the chapter 'Explanation of measurements'.

Seat shell: dyed-through polypropylene. All models are available with a seat cushion (screwed to the seat shell) or full upholstery. The fully upholstered version has moulded polyurethane foam padding covered in fabric, attached to the shell with a welted edge. Different shell and upholstery colours and various bases provide a multitude of possible combinations.

Options: the Eames Plastic Chair is available as a visitor chair, dining chair, rocking chair, swivel chair or in stacking versions and with ganging brackets for row seating. Beam-mounted shells are suited for use in waiting areas.

Eames Plastic Armchair PACC

Base: five-star base in polished die-cast aluminium with double castors in basic dark. (PACC = Pivot Armchair Cast Base on Castors)

PACC	Article no.	without VAT in SEK*	with VAT in SEK*
castor-based swivel chair, height-adjustable	440 355 00		
without upholstery		6.984,00	8.730,00
castor-based swivel chair, height-adjustable	440 356 00		
with seat upholstery			
Fabric F60		7.936,00	9.920,00
Fabric F200		9.184,00	11.480,00
castor-based swivel chair, height-adjustable	440 357 00		
with full upholstery			
Fabric F60		9.800,00	12.250,00

Fabric F60	Fabric F200	Seat shell	Edge	Castors
. Hopsak	. Checker	03 poppy red 04 white 11 pebble 12 deep black 23 ice grey 24 light grey 26 sunlight	34 mustard 41 pale rose 42 green 43 rusty orange 48 forest 56 granite grey 83 sea blue	01 basic dark 04 white 02 castors hard, braked for carpet 03 castors soft, braked for hard floor

Eames Plastic Side Chair PSCC

Charles & Ray Eames, 1950



All measurements are pursuant to EN 1335-1:2000
More detailed information is found in the chapter 'Explanation of measurements'.

Seat shell: dyed-through polypropylene. All models are available with a seat cushion (screwed to the seat shell) or full upholstery. The fully upholstered version has moulded polyurethane foam padding covered in fabric, attached to the shell with a welted edge. Different shell and upholstery colours and various bases provide a multitude of possible combinations.

Options: the Eames Plastic Chair is available as a visitor chair, dining chair, rocking chair, swivel chair or in stacking versions and with ganging brackets for row seating. Beam-mounted shells are suited for use in waiting areas.

Base: five-star base in polished die-cast aluminium with double castors in basic dark. (PSCC = Pivot Side Chair Cast Base on Castors)

PSCC	Article no.	without VAT in SEK*	with VAT in SEK*
castor-based swivel chair, height-adjustable	440 335 00		
without upholstery		5.848,00	7.310,00
castor-based swivel chair, height-adjustable	440 336 00		
with seat upholstery			
Fabric F60		6.872,00	8.590,00
Fabric F200		8.056,00	10.070,00
castor-based swivel chair, height-adjustable	440 337 00		
with full upholstery			
Fabric F60		7.880,00	9.850,00
Fabric F200		10.280,00	12.850,00

Fabric F60	Fabric F200	Seat shell	Edge	Castors
Hopsak	Checker	03 poppy red 04 white 11 pebble 12 deep black 23 ice grey 24 light grey 26 sunlight	34 mustard 41 pale rose 42 green 43 rusty orange 48 forest 56 granite grey 83 sea blue	01 basic dark 04 white 02 castors hard, braked for carpet 03 castors soft, braked for hard floor

Fauteuil Direction Pivotant

Jean Prouvé, 1951

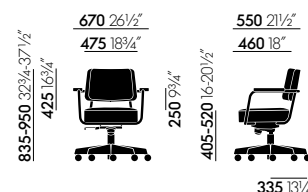

All measurements are pursuant to EN 1335-1:2000
More detailed information is found in the chapter 'Explanation of measurements'.

Seat and backrest: polyurethane filling; cover in fabric or leather.

Armrests: solid wood in natural oak with oiled finish, dark stained oak with protective natural lacquer finish, or American walnut with oiled finish.

Base: five-star base made of bent sheet steel and tubular steel, powder-coated (smooth). Equipped with double castors in basic dark, Ø 60 mm.

Seat mechanism: adjustable backward tilt, lockable in the forward position. Continuous seat height adjustment with gas spring.

Origin of wood: oak (*Quercus robur*) from Western Europe and/or Poland; American walnut (*Juglans nigra*) from the USA.

Note: the steel frame in Métal Brut has a raw irregular surface protected by a transparent powder coating.

Fauteuil Direction Pivotant

	Article no.	without VAT in SEK*	with VAT in SEK*
	210 474 00		
Backrest and seat fabric F60		25.336,00	31.670,00
Backrest and seat fabric F80		25.888,00	32.360,00
Backrest and seat leather L50		33.672,00	42.090,00
Surcharges base			
Colour group 1		0,00	0,00
Colour group 2		920,00	1.150,00

Fabric F60	Fabric F80	Leather L50	Armrests	Castors
<ul style="list-style-type: none"> 06 Twill 07 Volo 	<ul style="list-style-type: none"> 08 Tress 	<ul style="list-style-type: none"> 09 Leather Premium F 	<ul style="list-style-type: none"> 04 dark stained solid oak, with protective varnish 70 natural solid oak, oiled 75 solid American walnut, oiled 	<ul style="list-style-type: none"> 02 castors hard, braked for carpet 03 castors soft, braked for hard floor

Base frame Colour group 1

- 06 Japanese red powder-coated (smooth)
- 12 deep black powder-coated (smooth)
- 88 Prouvé Blanc Colombe (Ecrû) powder-coated (smooth)

Base frame Colour group 2

- 13 Prouvé Gris Vermeer powder-coated (smooth)
- 14 Prouvé Bleu Dynastie powder-coated (smooth)
- 18 Prouvé Blé Vert powder-coated (smooth)
- 41 Prouvé Bleu Marcoule powder-coated (smooth)
- 94 Prouvé Métal Brut powder-coated (transparent, smooth)

Grand Executive

Antonio Citterio, 2014



Grand Executive Lowback



Grand Executive Highback

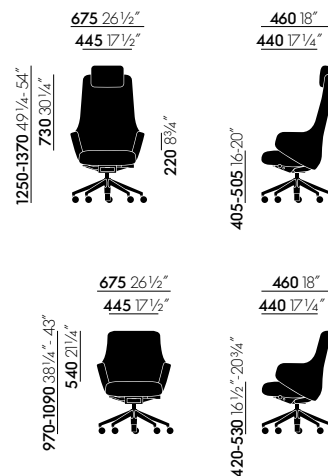

All measurements are pursuant to EN 1335-1:2000
 More detailed information is found in the chapter 'Explanation of measurements'.

Executive armchair in accordance with EN 1335.

Mechanism: FlowMotion mechanism with individual adjustment of backrest resistance.

Backrest and seat: seat shell with integrated armrests and height-adjustable neck cushion (Highback). Backrest shell made of plastic; seat and back upholstery made of polyurethane foam. Leather cover.

Base: five-star base in polished die-cast aluminium. With double castors (Ø 60 mm) for hard and soft floors in in basic dark.

Grand Executive Highback: high backrest with height-adjustable neck cushion.

Grand Executive Lowback: medium-height backrest without neck cushion.

Grand Executive Highback

	Article no.	without VAT in SEK*	with VAT in SEK*
	421 935 00		
Leather L20		38.880,00	48.600,00
Leather L50		48.048,00	60.060,00

Grand Executive Lowback

	Article no.	without VAT in SEK*	with VAT in SEK*
	421 937 00		
Leather L20		28.600,00	35.750,00
Leather L50		35.008,00	43.760,00

Leather L20

Leather

Leather L50

Leather Premium F

Castors

02 castors hard, braked for carpet
 03 castors soft, braked for hard floor

Grand Conference

Antonio Citterio, 2014

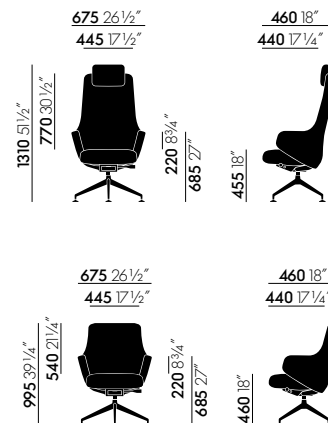

Grand Conference Lowback

Grand Conference Highback

All measurements are pursuant to EN 1335-1:2000
More detailed information is found in the chapter 'Explanation of measurements'.

Conference chair (swivel) in accordance with EN 16139.

Mechanism: FlowMotion conference mechanism with individual adjustment of backrest resistance. Fixed seat height with shock-absorbing seat suspension for added comfort.

Backrest and seat: seat shell with integrated armrests and height-adjustable neck cushion (Highback). Backrest shell made of plastic; seat and back upholstery made of polyurethane foam. Leather cover.

Base: four-star base in polished die-cast aluminium. Fitted with plastic glides for carpet or felt glides for hard floors.

Grand Conference Highback: high backrest with height-adjustable neck cushion.

Grand Conference Lowback: medium-height backrest without neck cushion.

Grand Conference Highback

	Article no.	without VAT in SEK*	with VAT in SEK*
	421 936 00		
Leather L20		38.880,00	48.600,00
Leather L50		48.048,00	60.060,00

Grand Conference Lowback

	Article no.	without VAT in SEK*	with VAT in SEK*
	421 938 00		
Leather L20		28.600,00	35.750,00
Leather L50		35.008,00	43.760,00

Leather L20

Leather

Leather L50

Leather Premium F

Glides

04 glides for carpet
05 felt glides for hard floor

HAL RE Studio

Jasper Morrison, 2010/2014

vitra.

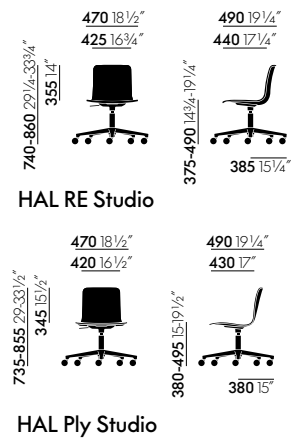

All measurements are pursuant to EN 1335-1:2000
More detailed information is found in the chapter 'Explanation of measurements'.

HAL RE Studio

Seat shell: dyed-through, recycled polypropylene.

Base: five-star base in die-cast aluminium powder-coated in basic dark. Swivel mechanism with shock-absorbing seat suspension, height-adjustable.

HAL Ply Studio

Seat shell: plywood (USA).

Base: five-star base in die-cast aluminium powder-coated in basic dark. Swivel mechanism with shock-absorbing seat suspension, height-adjustable.

HAL RE Studio

	Article no.	without VAT in SEK*	with VAT in SEK*
five-star base	440 517 00		
Base powder-coated basic dark, without seat upholstery		4.376,00	5.470,00
five-star base	440 518 00		
Base powder-coated basic dark, with seat upholstery F60		5.464,00	6.830,00

HAL Ply Studio

	Article no.	without VAT in SEK*	with VAT in SEK*
five-star base	440 229 00		
Base powder-coated basic dark, seat shell natural oak, with protective varnish	01	6.360,00	7.950,00
Base powder-coated basic dark, seat shell dark oak, with protective varnish	02	6.360,00	7.950,00

Seat fabric F60

Seat shell HAL RE

Castors

Hopsak	12 deep black RE 14 ivy RE 23 ice grey RE 29 brick RE 31 warm grey RE 35 basalt RE 85 cotton white RE 86 cardboard RE	02 castors hard, braked for carpet 03 castors soft, braked for hard floor
--------	--	--

HAL RE Armchair Studio

Jasper Morrison, 2010/2014

vitra.

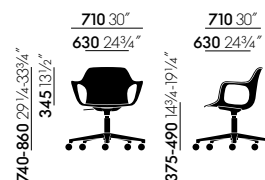

HAL RE Armchair Studio

All measurements are pursuant to EN 1335-1:2000
More detailed information is found in the chapter 'Explanation of measurements'.

HAL RE Armchair Studio

Seat shell: dyed-through recycled polypropylene, with optional seat cushion (screwed to the seat shell).

Base: five-star base in die-cast aluminium powder-coated in basic dark. Swivel mechanism with shock-absorbing seat suspension, height-adjustable.

HAL RE Armchair Studio

	Article no.	without VAT in SEK*	with VAT in SEK*
five-star base	440 515 00		
Base powder-coated basic dark, without seat upholstery		4.976,00	6.220,00
five-star base	440 516 00		
Base powder-coated basic dark, with seat upholstery F60		6.064,00	7.580,00

Seat fabric F60

Seat shell HAL RE

Castors

Hopsak	12 deep black RE 14 ivy RE 23 ice grey RE 29 brick RE 31 warm grey RE 35 basalt RE 85 cotton white RE 86 cardboard RE	02 castors hard, braked for carpet 03 castors soft, braked for hard floor
--------	--	--

ID Chair Concept

Antonio Citterio, 2010/2021



ID Chair Concept

ID Chair Concept is a chair system that can be configured based on the user's individual needs and preferences and gives the office a subtly elegant design and bright colours.

The office swivel chair range is made up of many components to satisfy a wide number of requirements in terms of aesthetics, materials, purpose and price. The right ID Chair can be chosen based on the following models:

- **ID Cloud** with membrane structure backrest
- **ID Air** with perforated plastic backrest.
- **ID Mesh** with padded mesh backrest.
- **ID Soft** with classic upholstered backrest.
- **ID Soft L** with high backrest.
- **ID Trim** with narrow backrest.
- **ID Trim L** with high backrest.

Starting with these models, different ID Chairs can be configured by selecting from the diverse mechanisms, seats, armrests, bases, frame colours and covers.

ID Chair Concept

Antonio Citterio, 2010/2021



Armrests

1. 3D armrests F
2. 2D armrests F
3. Ring armrests

Accessories

1. Headrest and clothes hanger (ID Mesh)
2. Clothes hanger (ID Soft L, ID Trim, ID Trim L)

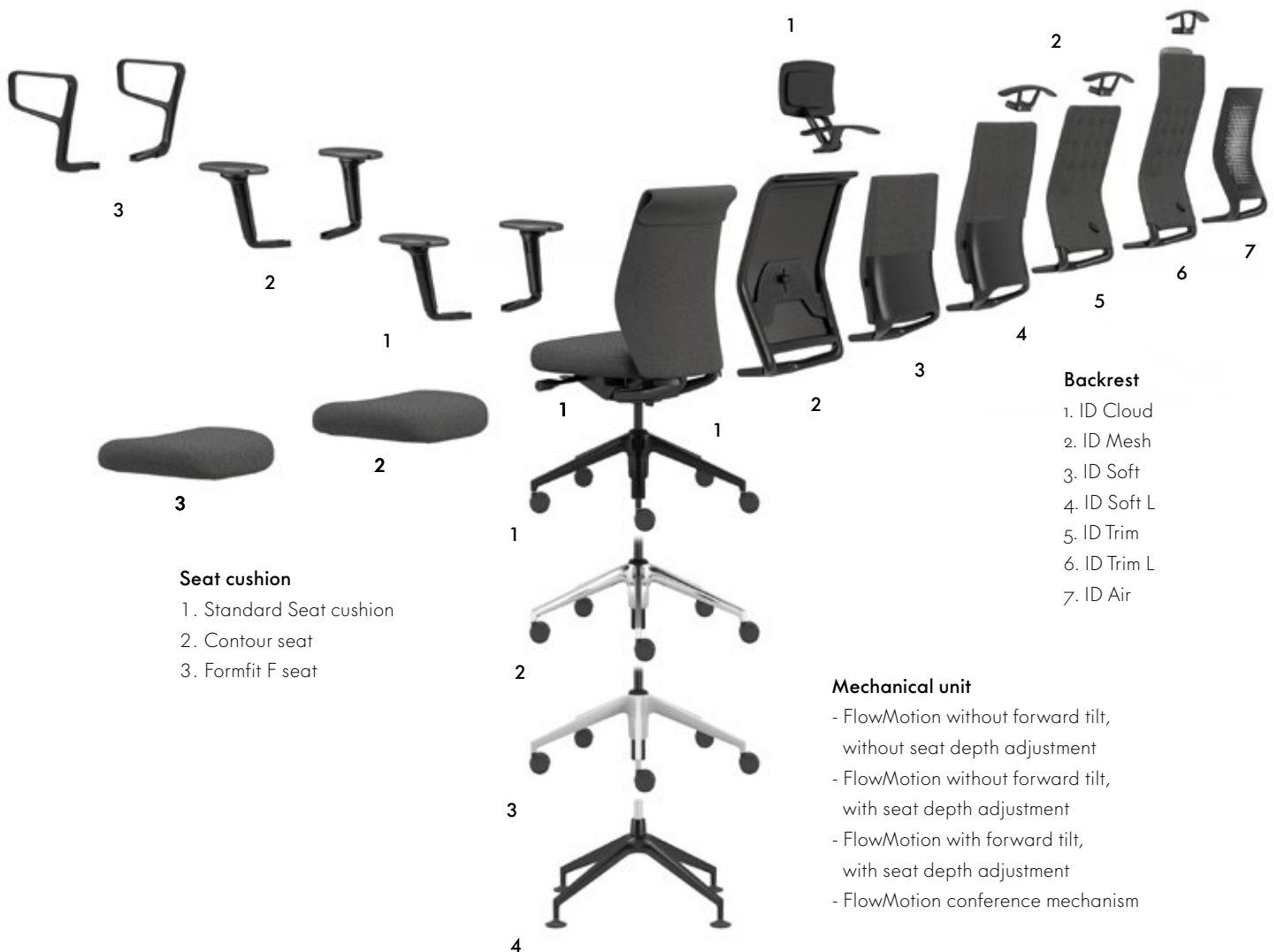

Seat cushion

1. Standard Seat cushion
2. Contour seat
3. Formfit F seat

Backrest

1. ID Cloud
2. ID Mesh
3. ID Soft
4. ID Soft L
5. ID Trim
6. ID Trim L
7. ID Air

Mechanical unit

- FlowMotion without forward tilt, without seat depth adjustment
- FlowMotion without forward tilt, with seat depth adjustment
- FlowMotion with forward tilt, with seat depth adjustment
- FlowMotion conference mechanism

Bases

1. Five-star base, plastic in basic dark
2. Five-star base, polished aluminium
3. Five-star base, coated aluminium
4. Four-star base, aluminium coated/polished

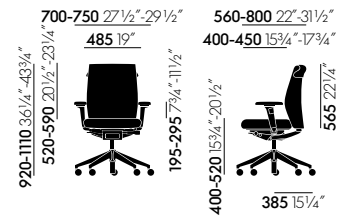
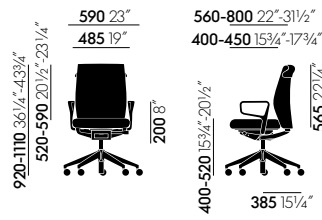
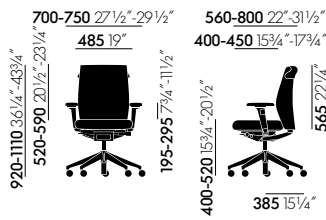

ID Cloud with 2D armrests

ID Cloud with ring armrests

ID Cloud with 2D armrests

All measurements are pursuant to EN 1335-1:2000
 More detailed information is found in the chapter 'Explanation of measurements'.

Office swivel chair with 2D or 3D armrests in accordance with EN 1335, Ergonomic Seal of Approval (LGA Nuremberg).

Seat mechanism: FlowMotion mechanism, lockable in upright sitting position. Seat mechanism matches the frame colour (basic dark or soft grey). Optionally with or without synchronous forward tilt (can be disabled) or seat depth adjustment. Individual adjustment of backrest resistance and forward tilt.

Backrest: height-adjustable backrest with a three-part construction: frame in polyamide, membrane in TPE and knit cover. Back connection in basic dark or soft grey. Knit cover in Duo Knit.

Armrests: 2D armrests with adjustable height and width or 3D armrests with adjustable height, width and depth and 360° swivel function. Armrest supports in aluminium, polished or powder-coated in the colours basic dark or soft grey (to match the frame colour). Armrest sleeves in polyamide are matched to the frame colour (basic dark or soft grey). With PU-foam-free (F) pads in basic dark (for frame colour basic dark) or dim grey (for frame colour soft grey). Optionally available with ring armrests for use in conference settings, made of die-cast aluminium, polished or powder-coated in basic dark or soft grey (to match the frame colour).

Seat: polyurethane foam padding. Optional contour seat or PU-foam-free formfit (F) seat. Seat cover in woven fabric or 3D spacer fabric.

Base: five-star base in polyamide (basic dark) or die-cast aluminium, polished or powder-coated in basic dark or soft grey (to match the frame colour), with double castors (Ø 60 mm) or glides.

Conference version: conference chair (swivel) with four-star base made of die-cast aluminium, polished or powder-coated in basic dark or soft grey (to match frame colour) on glides in accordance with EN 16139. FlowMotion conference mechanism (no forward tilt, no seat depth adjustment) with individual adjustment of backrest resistance; fixed seat height with shock-absorbing seat suspension for added comfort.

ID Cloud

Antonio Citterio, 2021



ID Cloud	Article no.	without VAT in SEK*	with VAT in SEK*
	431 409 00		
Backrest Duo Knit, seat Silk Mesh		8.936,00	11.170,00
Backrest Duo Knit, seat fabric F30		8.936,00	11.170,00
Backrest Duo Knit, seat fabric F40		9.048,00	11.310,00
Backrest Duo Knit, seat fabric F60		9.320,00	11.650,00
Surcharges mechanical elements			
FlowMotion without forward tilt, without seat depth adjustment	11	0,00	0,00
FlowMotion without forward tilt, with seat depth adjustment	13	560,00	700,00
FlowMotion with forward tilt, with seat depth adjustment	14	1.176,00	1.470,00
FlowMotion conference mechanism	17	0,00	0,00
Surcharges seat			
standard seat	01	0,00	0,00
Contour seat (only for mechanism with seat depth adjustment)	02	616,00	770,00
Formfit F seat (only for mechanism with seat depth adjustment / in Plano, Silk Mesh or Reflect)	03	616,00	770,00
Surcharges armrests			
without armrests	21	0,00	0,00
2D armrests F, polished aluminium	23	1.488,00	1.860,00
2D armrests F, powder-coated aluminium	24	1.488,00	1.860,00
3D armrests F, polished aluminium	25	2.136,00	2.670,00
3D armrests F, powder-coated aluminium	29	2.136,00	2.670,00
ring armrests, polished aluminium	27	2.136,00	2.670,00
ring armrests, powder-coated aluminium	28	2.136,00	2.670,00
Surcharges base			
five-star base, plastic, basic dark	31	0,00	0,00
five-star base, polished aluminium	32	1.592,00	1.990,00
five-star base, powder-coated aluminium	30	1.592,00	1.990,00
four-star base, polished aluminium (only for FlowMotion conference)	33	1.592,00	1.990,00
four-star base, powder-coated aluminium	34	1.592,00	1.990,00

Fabric F30	Fabric F40	Fabric F60	Frame	Castors/Glides
Plano	Laser RE Reflect	Volo	30 basic dark 53 soft grey	02 castors hard, braked for carpet 03 castors soft, braked for hard floor 04 glides for carpet 05 felt glides for hard floor

ID Air

Antonio Citterio, 2012/2021

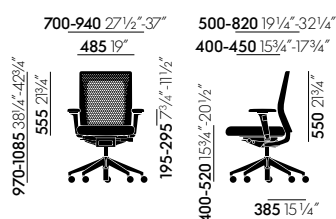

ID Air with 3D armrests

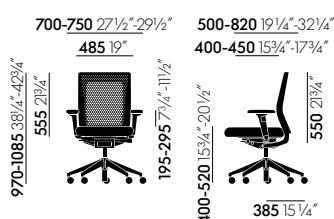

ID Air with 2D armrests

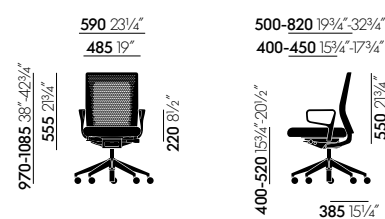

ID Air with fixed ring armrests

All measurements are pursuant to EN 1335-1:2000

More detailed information is found in the chapter 'Explanation of measurements'.

Office swivel chair with 2D or 3D armrests in accordance with EN 1335, Ergonomic Seal of Approval (LGA Nuremberg).

Seat mechanism: FlowMotion mechanism, lockable in upright sitting position. Seat mechanism matches the frame colour (basic dark or soft grey). Optionally with or without synchronous forward tilt (can be disabled) or seat depth adjustment. Individual adjustment of backrest resistance and forward tilt.

Backrest: perforated plastic backrest in polypropylene (basic dark or soft grey).

Armrests: 2D armrests with adjustable height and width or 3D armrests with adjustable height, width and depth and 360° swivel function. Armrest supports in aluminium, polished or powder-coated in the colours basic dark or soft grey (to match the frame colour). Armrest sleeves in polyamide are matched to the frame colour (basic dark or soft grey). With PU-foam-free (F) pads in basic dark (for frame colour basic dark) or dim grey (for frame colour soft grey). Optionally available with ring armrests for use in conference settings, made of die-cast aluminium, polished or powder-coated in basic dark or soft grey (to match the frame colour).

Seat: polyurethane foam padding. Optional contour seat or PU-foam-free formfit (F) seat. Seat cover in woven fabric or 3D spacer fabric.

Base: five-star base in polyamide (basic dark) or die-cast aluminium, polished or powder-coated in basic dark or soft grey (to match the frame colour), with double castors (Ø 60 mm) or glides.

Conference version: conference chair (swivel) with four-star base made of die-cast aluminium, polished or powder-coated in basic dark or soft grey (to match frame colour) on glides in accordance with EN 16139. FlowMotion conference mechanism (no forward tilt, no seat depth adjustment) with individual adjustment of backrest resistance; fixed seat height with shock-absorbing seat suspension for added comfort.



ID Air	Article no.	without VAT in SEK*	with VAT in SEK*
	431 407 00		
Seat Silk Mesh		6.584,00	8.230,00
Seat fabric F30		6.584,00	8.230,00
Seat fabric F40		6.704,00	8.380,00
Seat fabric F60		6.928,00	8.660,00
Surcharges mechanical elements			
FlowMotion without forward tilt, without seat depth adjustment	11	0,00	0,00
FlowMotion without forward tilt, with seat depth adjustment	13	560,00	700,00
FlowMotion with forward tilt, with seat depth adjustment	14	1.176,00	1.470,00
FlowMotion conference mechanism	17	0,00	0,00
Surcharges seat			
standard seat	01	0,00	0,00
Contour seat (only for mechanism with seat depth adjustment)	02	616,00	770,00
Formfit F seat (only for mechanism with seat depth adjustment / in Plano, Silk Mesh or Reflect)	03	616,00	770,00
Surcharges armrests			
without armrests	21	0,00	0,00
2D armrests F, polished aluminium	23	1.488,00	1.860,00
2D armrests F, powder-coated aluminium	24	1.488,00	1.860,00
3D armrests F, polished aluminium	25	2.136,00	2.670,00
3D armrests F, powder-coated aluminium	29	2.136,00	2.670,00
ring armrests, polished aluminium	27	2.136,00	2.670,00
ring armrests, powder-coated aluminium	28	2.136,00	2.670,00
Surcharges base			
five-star base, plastic, basic dark	31	0,00	0,00
five-star base, polished aluminium	32	1.592,00	1.990,00
five-star base, powder-coated aluminium	30	1.592,00	1.990,00
four-star base, polished aluminium (only for FlowMotion conference)	33	1.592,00	1.990,00
four-star base, powder-coated aluminium	34	1.592,00	1.990,00

Fabric F30	Fabric F40	Fabric F60	Backrest colour ID Air	Frame	Castors/Glides
Plano	Laser RE Reflect	Volo	30 basic dark 53 soft grey	30 basic dark 53 soft grey	02 castors hard, braked for carpet 03 castors soft, braked for hard floor 04 glides for carpet 05 felt glides for hard floor

ID Mesh

Antonio Citterio, 2010/2021

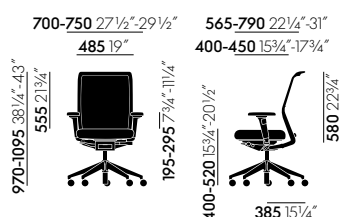

ID Mesh with 2D armrests

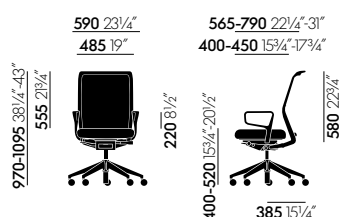

ID Mesh with ring armrests

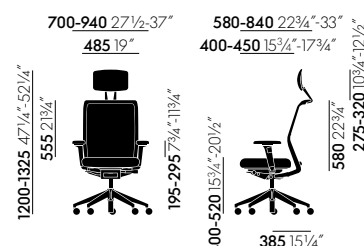

ID Mesh with 3D armrests and headrest

All measurements are pursuant to EN 1335-1:2000
 More detailed information is found in the chapter 'Explanation of measurements'.

Office swivel chair with 2D or 3D armrests in accordance with EN 1335, Ergonomic Seal of Approval (LGA Nuremberg). The version equipped with the FlowMotion mechanism with forward tilt and seat depth adjustment complies with BS 5459-2 (24-hour test).

Seat mechanism: FlowMotion mechanism, lockable in upright sitting position. Seat mechanism matches the frame colour (basic dark or soft grey). Optionally with or without synchronous forward tilt (can be disabled) or seat depth adjustment. Individual adjustment of backrest resistance and forward tilt.

Backrest: frame in polyamide (basic dark or soft grey). With height-adjustable lumbar support. Backrest cover in Diamond Mesh 3D spacer fabric (mesh look) or Silk Mesh (solid look). For Silk Mesh in the colour soft grey, the reverse side is in soft grey. For Silk Mesh in the colours nero and asphalt, the reverse side is in nero. For Silk Mesh in the colours olive green, smoke blue and dim grey, the reverse side matches the frame colour (soft grey or nero).

Armrests: 2D armrests with adjustable height and width or 3D armrests with adjustable height, width and depth and 360° swivel function. Armrest supports in aluminium, polished or powder-coated in the colours basic dark or soft grey (to match the frame colour). Armrest sleeves in polyamide are matched to the frame colour (basic dark or soft grey). With PU-foam-free (F) pads in basic dark (for frame colour basic dark) or dim grey (for frame colour soft grey). Optionally available with ring armrests for use in conference settings, made of die-cast aluminium, polished or powder-coated in basic dark or soft grey (to match the frame colour).

Seat: polyurethane foam padding. Optional contour seat or PU-foam-free formfit (F) seat. Seat cover in woven fabric or 3D spacer fabric.

Base: five-star base in polyamide (basic dark) or die-cast aluminium, polished or powder-coated in basic dark or soft grey (to match the frame colour), with double castors (Ø 60 mm) or glides.

Accessories: headrest in polyamide (basic dark or soft grey) with adjustable angle and height, retrofit option. With polyurethane pad in basic dark (for headrest in basic dark) or dim grey (for headrest in soft grey). Clothes hanger in polyamide (basic dark or soft grey), retrofit option (max. weight load: 2 kg). Headrest and clothes hanger can be used separately or combined.

Conference version: conference chair (swivel) with four-star base made of die-cast aluminium, polished or powder-coated in basic dark or soft grey (to match frame colour) on glides in accordance with EN 16139. FlowMotion conference mechanism (no forward tilt, no seat depth adjustment) with individual adjustment of backrest resistance; fixed seat height with shock-absorbing seat suspension for added comfort.

Fabric F30	Fabric F40	Fabric F60	Frame	Castors/Glides
Plano	Laser RE Reflect	Volo	30 basic dark 53 soft grey	02 castors hard, braked for carpet 03 castors soft, braked for hard floor 04 glides for carpet 05 felt glides for hard floor

ID Mesh

Antonio Citterio, 2010/2021

vitra.



ID Mesh	Article no.	without VAT in SEK*	with VAT in SEK*
	431 401 00		
Backrest Diamond Mesh, seat Silk Mesh		6.712,00	8.390,00
Backrest Diamond Mesh, seat fabric F30		6.712,00	8.390,00
Backrest Diamond Mesh, seat fabric F40		6.824,00	8.530,00
Backrest Diamond Mesh, seat fabric F60		7.112,00	8.890,00
Seat and backrest Silk Mesh		6.712,00	8.390,00
Backrest Silk Mesh, seat fabric F30		6.712,00	8.390,00
Backrest Silk Mesh, seat fabric F40		6.824,00	8.530,00
Backrest Silk Mesh, seat fabric F60		7.112,00	8.890,00
Surcharges mechanical elements			
FlowMotion without forward tilt, without seat depth adjustment	11	0,00	0,00
FlowMotion without forward tilt, with seat depth adjustment	13	560,00	700,00
FlowMotion with forward tilt, with seat depth adjustment	14	1.176,00	1.470,00
FlowMotion conference mechanism	17	0,00	0,00
Surcharges seat			
standard seat	01	0,00	0,00
Contour seat (only for mechanism with seat depth adjustment)	02	616,00	770,00
Formfit F seat (only for mechanism with seat depth adjustment / in Plano, Silk Mesh or Reflect)	03	616,00	770,00
Surcharges armrests			
without armrests	21	0,00	0,00
2D armrests F, polished aluminium	23	1.488,00	1.860,00
2D armrests F, powder-coated aluminium	24	1.488,00	1.860,00
3D armrests F, polished aluminium	25	2.136,00	2.670,00
3D armrests F, powder-coated aluminium	29	2.136,00	2.670,00
ring armrests, polished aluminium	27	2.136,00	2.670,00
ring armrests, powder-coated aluminium	28	2.136,00	2.670,00
Surcharges base			
five-star base, plastic, basic dark	31	0,00	0,00
five-star base, polished aluminium	32	1.592,00	1.990,00
five-star base, powder-coated aluminium	30	1.592,00	1.990,00
four-star base, polished aluminium (only for FlowMotion conference)	33	1.592,00	1.990,00
four-star base, powder-coated aluminium	34	1.592,00	1.990,00

Accessory	Article no.	without VAT in SEK*	with VAT in SEK*
Headrest	431 000 00		
		1.168,00	1.460,00
Clothes hanger	431 010 00		
		560,00	700,00
Set of headrest and clothes hanger	431 020 00		
		1.728,00	2.160,00



ID Mesh, seat cover in Plano nero, back cover in Diamond Mesh nero	Article no.	without VAT in SEK*	with VAT in SEK*
Hard braked castors for carpet	QS3 140 1A	9.376,00	11.720,00
Soft braked castors for hard floors	QS3 140 1B	9.376,00	11.720,00

ID Soft

Antonio Citterio, 2010/2021



ID Soft with 3D armrests

ID Soft with 3D armrests

ID Soft with 2D armrests

All measurements are pursuant to EN 1335-1:2000

More detailed information is found in the chapter 'Explanation of measurements'.

Office swivel chair with 2D or 3D armrests in accordance with EN 1335, Ergonomic Seal of Approval (LGA Nuremberg). The version equipped with the FlowMotion mechanism with forward tilt and seat depth adjustment complies with BS 5459-2 (24-hour test).

Seat mechanism: FlowMotion mechanism, lockable in upright sitting position. Seat mechanism matches the frame colour (basic dark or soft grey). Optionally with or without synchronous forward tilt (can be disabled) or seat depth adjustment. Individual adjustment of backrest resistance and forward tilt.

Backrest: height-adjustable backrest in polyamide (basic dark or soft grey) with padded cushion in polyurethane foam. Cover in fabric, in Striped Knit or in 3D spacer fabric.

Armrests: 2D armrests with adjustable height and width or 3D armrests with adjustable height, width and depth and 360° swivel function. Armrest supports in aluminium, polished or powder-coated in the colours basic dark or soft grey (to match the frame colour). Armrest sleeves in polyamide are matched to the frame colour (basic dark or soft grey). With PU-foam-free (F) pads in basic dark (for frame colour basic dark) or dim grey (for frame colour soft grey). Optionally available with ring armrests for use in conference settings, made of die-cast aluminium, polished or powder-coated in basic dark or soft grey (to match the frame colour).

Seat: polyurethane foam padding. Optionally available with contoured seat. Seat cover in woven fabric or 3D spacer fabric.

Base: five-star base in polyamide (basic dark) or die-cast aluminium, polished or powder-coated in basic dark or soft grey (to match the frame colour), with double castors (Ø 60 mm) or glides.

Conference version: conference chair (swivel) with four-star base made of die-cast aluminium, polished or powder-coated in basic dark or soft grey (to match frame colour) on glides in accordance with EN 16139. FlowMotion conference mechanism (no forward tilt, no seat depth adjustment) with individual adjustment of backrest resistance; fixed seat height with shock-absorbing seat suspension for added comfort.



ID Soft	Article no.	without VAT in SEK*	with VAT in SEK*
	431 402 00		
Backrest and seat Silk Mesh		7.696,00	9.620,00
Backrest and seat fabric F30		7.696,00	9.620,00
Backrest and seat fabric F40		7.912,00	9.890,00
Backrest and seat fabric F60		8.544,00	10.680,00
Backrest Striped Knit, seat Silk Mesh		8.432,00	10.540,00
Backrest Striped Knit, seat fabric F30		8.432,00	10.540,00
Backrest Striped Knit, seat fabric F40		8.552,00	10.690,00
Backrest Striped Knit, seat fabric F60		8.840,00	11.050,00
Surcharges mechanical elements			
FlowMotion without forward tilt, without seat depth adjustment	11	0,00	0,00
FlowMotion without forward tilt, with seat depth adjustment	13	560,00	700,00
FlowMotion with forward tilt, with seat depth adjustment	14	1.176,00	1.470,00
FlowMotion conference mechanism	17	0,00	0,00
Surcharges seat			
standard seat	01	0,00	0,00
contour seat (only for mechanism with seat depth adjustment)	02	616,00	770,00
Surcharges armrests			
without armrests	21	0,00	0,00
2D armrests F, polished aluminium	23	1.488,00	1.860,00
2D armrests F, powder-coated aluminium	24	1.488,00	1.860,00
3D armrests F, polished aluminium	25	2.136,00	2.670,00
3D armrests F, powder-coated aluminium	29	2.136,00	2.670,00
ring armrests, polished aluminium	27	2.136,00	2.670,00
ring armrests, powder-coated aluminium	28	2.136,00	2.670,00
Surcharges base			
five-star base, plastic, basic dark	31	0,00	0,00
five-star base, polished aluminium	32	1.592,00	1.990,00
five-star base, powder-coated aluminium	30	1.592,00	1.990,00
four-star base, polished aluminium (only for FlowMotion conference)	33	1.592,00	1.990,00
four-star base, powder-coated aluminium	34	1.592,00	1.990,00



ID Soft, seat and backrest covers in Plano nero

	Article no.	without VAT in SEK*	with VAT in SEK*
Hard braked castors for carpet	QS3 140 2A	10.360,00	12.950,00
FlowMotion mechanism with forward tilt and seat depth adjustment; frame in colour basic dark; 2D armrests F, polished aluminium; five-star base in plastic, basic dark			
Soft braked castors for hard floors	QS3 140 2B	10.360,00	12.950,00
FlowMotion mechanism with forward tilt and seat depth adjustment; frame in colour basic dark; 2D armrests F, polished aluminium; five-star base in plastic, basic dark			

Fabric F30	Fabric F40	Fabric F60	Frame	Castors/Glides
Plano	Laser RE Reflect	Volo	30 basic dark 53 soft grey	02 castors hard, braked for carpet 03 castors soft, braked for hard floor 04 glides for carpet 05 felt glides for hard floor

ID Soft L

Antonio Citterio, 2016/2021

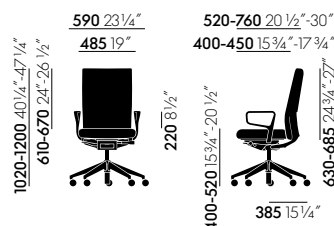

ID Soft L with ring armrests

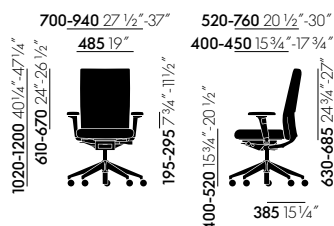

ID Soft L with 3D armrests

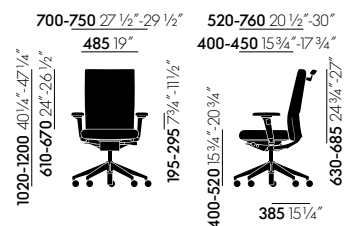

ID Soft L with 2D armrests and clothes hanger

All measurements are pursuant to EN 1335-1:2000

More detailed information is found in the chapter 'Explanation of measurements'.

Office swivel chair with 2D or 3D armrests in accordance with EN 1335, Ergonomic Seal of Approval (LGA Nuremberg).

Seat mechanism: FlowMotion mechanism, lockable in upright sitting position. Seat mechanism matches the frame colour (basic dark or soft grey). Optionally with or without synchronous forward tilt (can be disabled) or seat depth adjustment. Individual adjustment of backrest resistance and forward tilt.

Backrest: height-adjustable high backrest in polyamide (basic dark or soft grey) with padded cushion in polyurethane foam. Seat cover in woven fabric or 3D spacer fabric.

Armrests: 2D armrests with adjustable height and width or 3D armrests with adjustable height, width and depth and 360° swivel function. Armrest supports in aluminium, polished or powder-coated in the colours basic dark or soft grey (to match the frame colour). Armrest sleeves in polyamide are matched to the frame colour (basic dark or soft grey). With PU-foam-free (F) pads in basic dark (for frame colour basic dark) or dim grey (for frame colour soft grey). Optionally available with ring armrests for use in conference settings, made of die-cast aluminium, polished or powder-coated in basic dark or soft grey (to match the frame colour).

Seat: polyurethane foam padding. Optionally available with contoured seat. Seat and back covers in woven fabric or 3D spacer fabric.

Base: five-star base in polyamide (basic dark) or die-cast aluminium, polished or powder-coated in basic dark or soft grey (to match the frame colour), with double castors (Ø 60 mm) or glides.

Accessories: clothes hanger in polyamide (basic dark or soft grey), max. weight load: 2 kg.

Conference version: conference chair (swivel) with four-star base made of die-cast aluminium, polished or powder-coated in basic dark or soft grey (to match frame colour) on glides in accordance with EN 16139. FlowMotion conference mechanism (no forward tilt, no seat depth adjustment) with individual adjustment of backrest resistance; fixed seat height with shock-absorbing seat suspension for added comfort.

ID Soft L

Antonio Citterio, 2016/2021

vitra.



ID Soft L	Article no.	without VAT in SEK*	with VAT in SEK*
	431 408 00		
Backrest and seat Silk Mesh		8.848,00	11.060,00
Backrest and seat fabric F30		8.848,00	11.060,00
Backrest and seat fabric F40		9.192,00	11.490,00
Backrest and seat fabric F60		10.064,00	12.580,00
Surcharges mechanical elements			
FlowMotion without forward tilt, without seat depth adjustment	11	0,00	0,00
FlowMotion without forward tilt, with seat depth adjustment	13	560,00	700,00
FlowMotion with forward tilt, with seat depth adjustment	14	1.176,00	1.470,00
FlowMotion conference mechanism	17	0,00	0,00
Surcharges seat			
standard seat	01	0,00	0,00
contour seat (only for mechanism with seat depth adjustment)	02	616,00	770,00
Surcharges armrests			
without armrests	21	0,00	0,00
2D armrests F, polished aluminium	23	1.488,00	1.860,00
2D armrests F, powder-coated aluminium	24	1.488,00	1.860,00
3D armrests F, polished aluminium	25	2.136,00	2.670,00
3D armrests F, powder-coated aluminium	29	2.136,00	2.670,00
ring armrests, polished aluminium	27	2.136,00	2.670,00
ring armrests, powder-coated aluminium	28	2.136,00	2.670,00
Surcharges base			
five-star base, plastic, basic dark	31	0,00	0,00
five-star base, polished aluminium	32	1.592,00	1.990,00
five-star base, powder-coated aluminium	30	1.592,00	1.990,00
four-star base, polished aluminium (only for FlowMotion conference)	33	1.592,00	1.990,00
four-star base, powder-coated aluminium	34	1.592,00	1.990,00
Accessories			
clothes hanger (mounted on chair)	42	944,00	1.180,00

Fabric F30	Fabric F40	Fabric F60	Frame	Castors/Glides
Plano	Laser RE Reflect	Volo	30 basic dark 53 soft grey	02 castors hard, braked for carpet 03 castors soft, braked for hard floor 04 glides for carpet 05 felt glides for hard floor

ID Trim

Antonio Citterio, 2010/2021

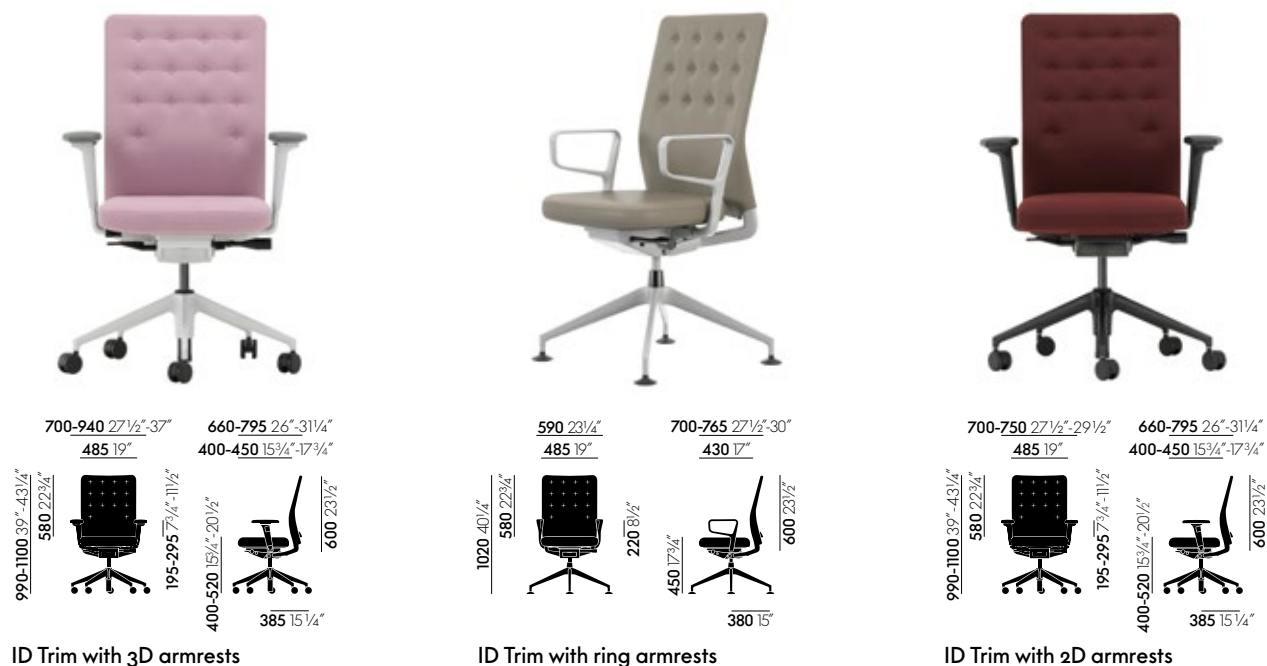

All measurements are pursuant to EN 1335-1:2000

More detailed information is found in the chapter 'Explanation of measurements'.

Office swivel chair with 2D or 3D armrests in accordance with EN 1335, Ergonomic Seal of Approval (LGA Nuremberg). The version equipped with the FlowMotion mechanism with forward tilt and seat depth adjustment complies with BS 5459-2 (24-hour test).

Seat mechanism: FlowMotion mechanism, lockable in upright sitting position. Seat mechanism matches the frame colour (basic dark or soft grey). Optionally with or without synchronous forward tilt (can be disabled) or seat depth adjustment. Individual adjustment of backrest resistance and forward tilt.

Backrest: frame in polyamide (basic dark or soft grey). Optional height-adjustable lumbar cushion. Cover in fabric or leather.

Armrests: 2D armrests with adjustable height and width or 3D armrests with adjustable height, width and depth and 360° swivel function. Armrest supports in aluminium, polished or powder-coated in the colours basic dark or soft grey (to match the frame colour). Armrest sleeves in polyamide are matched to the frame colour (basic dark or soft grey). With PU-foam-free (F) pads in basic dark (for frame colour basic dark) or dim grey (for frame colour soft grey). Optionally available with ring armrests for use in conference settings, made of die-cast aluminium, polished or powder-coated in basic dark or soft grey (to match the frame colour).

Seat: polyurethane foam padding. Optionally available with contoured seat. Seat and back covers in fabric or leather. Leather covers are not recommended for chairs with forward tilt, since a leather surface might cause users to slide off the seat.

Base: five-star base in polyamide (basic dark) or die-cast aluminium, polished or powder-coated in basic dark or soft grey (to match the frame colour), with double castors (Ø 60 mm) or glides.

Accessories: clothes hanger in polyamide (basic dark or soft grey), max. weight load: 2 kg.

Conference version: conference chair (swivel) with four-star base made of die-cast aluminium, polished or powder-coated in basic dark or soft grey (to match frame colour) on glides in accordance with EN 16139. FlowMotion conference mechanism (no forward tilt, no seat depth adjustment) with individual adjustment of backrest resistance; fixed seat height with shock-absorbing seat suspension for added comfort.

ID Trim

Antonio Citterio, 2010/2021

vitra.



ID Trim	Article no.	without VAT in SEK*	with VAT in SEK*
	431 403 00		
Backrest and seat fabric F30		8.008,00	10.010,00
Backrest and seat fabric F40		8.224,00	10.280,00
Backrest and seat fabric F60		9.056,00	11.320,00
Backrest and seat leather L20		17.016,00	21.270,00
Surcharges mechanical elements			
without adjustable lumbar support	51	0,00	0,00
with adjustable lumbar support	52	536,00	670,00
Surcharges mechanical elements			
FlowMotion without forward tilt, without seat depth adjustment	11	0,00	0,00
FlowMotion without forward tilt, with seat depth adjustment	13	560,00	700,00
FlowMotion with forward tilt, with seat depth adjustment	14	1.176,00	1.470,00
FlowMotion conference mechanism	17	0,00	0,00
Surcharges seat			
standard seat	01	0,00	0,00
contour seat (only for mechanism with seat depth adjustment)	02	616,00	770,00
Surcharges armrests			
without armrests	21	0,00	0,00
2D armrests F, polished aluminium	23	1.488,00	1.860,00
2D armrests F, powder-coated aluminium	24	1.488,00	1.860,00
3D armrests F, polished aluminium	25	2.136,00	2.670,00
3D armrests F, powder-coated aluminium	29	2.136,00	2.670,00
ring armrests, polished aluminium	27	2.136,00	2.670,00
ring armrests, powder-coated aluminium	28	2.136,00	2.670,00
Surcharges base			
five-star base, plastic, basic dark	31	0,00	0,00
five-star base, polished aluminium	32	1.592,00	1.990,00
five-star base, powder-coated aluminium	30	1.592,00	1.990,00
four-star base, polished aluminium (only for FlowMotion conference)	33	1.592,00	1.990,00
four-star base, powder-coated aluminium	34	1.592,00	1.990,00
Accessories			
clothes hanger (mounted on chair)	42	912,00	1.140,00

Fabric F30	Fabric F40	Fabric F60	Leather L20	Frame	Castors/Glides
Plano	Laser RE Reflect	Volo	Leather	30 basic dark 53 soft grey	02 castors hard, braked for carpet 03 castors soft, braked for hard floor 04 glides for carpet 05 felt glides for hard floor

* recommended retail price

1/2023 (SE-EN)

39

ID Trim L

Antonio Citterio, 2010/2021



ID Trim L with 3D armrests and clothes hanger

ID Trim L with ring armrests

ID Trim L with ring armrests

All measurements are pursuant to EN 1335-1:2000
 More detailed information is found in the chapter 'Explanation of measurements'.

Office swivel chair with 2D or 3D armrests in accordance with EN 1335, Ergonomic Seal of Approval (LGA Nuremberg). The version equipped with the FlowMotion mechanism with forward tilt and seat depth adjustment complies with BS 5459-2 (24-hour test).

Seat mechanism: FlowMotion mechanism, lockable in upright sitting position. Seat mechanism matches the frame colour (basic dark or soft grey). Optionally with or without synchronous forward tilt (can be disabled) or seat depth adjustment. Individual adjustment of backrest resistance and forward tilt.

Backrest: high backrest with integrated, height-adjustable headrest. Backrest frame in polyamide (basic dark or soft grey). Optional height-adjustable lumbar cushion. Cover in fabric or leather. Headrest for leather upholstery in the corresponding leather colour; for fabric upholstery, headrest covered in dim grey leather or nero leather.

Armrests: 2D armrests with adjustable height and width or 3D armrests with adjustable height, width and depth and 360° swivel function. Armrest supports in aluminium, polished or powder-coated in the colours basic dark or soft grey (to match the frame colour). Armrest sleeves in polyamide are matched to the frame colour (basic dark or soft grey). With PU-foam-free (F) pads in basic dark (for frame colour basic dark) or dim grey (for frame colour soft grey). Optionally available with ring armrests for use in conference settings, made of die-cast aluminium, polished or powder-coated in basic dark or soft grey (to match the frame colour).

Seat: polyurethane foam padding. Optionally available with contoured seat. Seat and back covers in fabric or leather. Leather covers are not recommended for chairs with forward tilt, since a leather surface might cause users to slide off the seat.

Base: five-star base in polyamide (basic dark) or die-cast aluminium, polished or powder-coated in basic dark or soft grey (to match the frame colour), with double castors (Ø 60 mm) or glides.

Accessories: clothes hanger in polyamide (basic dark or soft grey), max. weight load: 2 kg.

Conference version: conference chair (swivel) with four-star base made of die-cast aluminium, polished or powder-coated in basic dark or soft grey (to match frame colour) on glides in accordance with EN 16139. FlowMotion conference mechanism (no forward tilt, no seat depth adjustment) with individual adjustment of backrest resistance; fixed seat height with shock-absorbing seat suspension for added comfort.

ID Trim L

Antonio Citterio, 2010/2021



ID Trim L	Article no.	without VAT in SEK*	with VAT in SEK*
	431 404 00		
Backrest and seat fabric F30		9.096,00	11.370,00
Backrest and seat fabric F40		9.296,00	11.620,00
Backrest and seat fabric F60		10.248,00	12.810,00
Backrest and seat leather L20		18.544,00	23.180,00
Surcharges lumbar support			
without adjustable lumbar support	51	0,00	0,00
with adjustable lumbar support	52	536,00	670,00
Surcharges mechanical elements			
FlowMotion without forward tilt, without seat depth adjustment	11	0,00	0,00
FlowMotion without forward tilt, with seat depth adjustment	13	560,00	700,00
FlowMotion with forward tilt, with seat depth adjustment	14	1.176,00	1.470,00
FlowMotion conference mechanism	17	0,00	0,00
Surcharges seat			
standard seat	01	0,00	0,00
contour seat (only for mechanism with seat depth adjustment)	02	616,00	770,00
Surcharges armrests			
without armrests	21	0,00	0,00
2D armrests F, polished aluminium	23	1.488,00	1.860,00
2D armrests F, powder-coated aluminium	24	1.488,00	1.860,00
3D armrests F, polished aluminium	25	2.136,00	2.670,00
3D armrests F, powder-coated aluminium	29	2.136,00	2.670,00
ring armrests, polished aluminium	27	2.136,00	2.670,00
ring armrests, powder-coated aluminium	28	2.136,00	2.670,00
Surcharges base			
five-star base, plastic, basic dark	31	0,00	0,00
five-star base, polished aluminium	32	1.592,00	1.990,00
five-star base, powder-coated aluminium	30	1.592,00	1.990,00
four-star base, polished aluminium (only for FlowMotion conference)	33	1.592,00	1.990,00
four-star base, powder-coated aluminium	34	1.592,00	1.990,00
Accessories			
clothes hanger (mounted on chair)	42	912,00	1.140,00

Fabric F30	Fabric F40	Fabric F60	Leather L20	Headrest, leather (with fabric cover)	Frame	Castors/Glides
Plano	Laser RE Reflect	Volo	Leather	21 dim grey 66 nero	30 basic dark 53 soft grey	02 castors hard, braked for carpet 03 castors soft, braked for hard floor 04 glides for carpet 05 felt glides for hard floor

Lobby Chair

Charles & Ray Eames, 1960

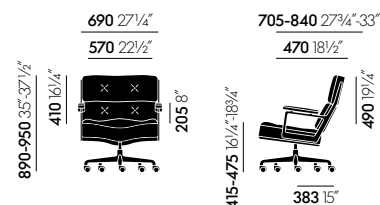

ES 104

All measurements are pursuant to EN 1335-1:2000
 More detailed information is found in the chapter 'Explanation of measurements'.

Seat mechanism: adjustable backward tilt. Continuous seat height adjustment with gas spring. Swivel seat.

Backrest and seat: side frames in chrome-plated die-cast aluminium. Cushion elements covered in leather.

Armrests: upholstered in leather.

Base: five-star base in chrome-plated die-cast aluminium, on castors. Equipped with hard castors for carpet or soft castors for hard floors.

Options: also available as a conference chair equipped with glides or in a wider version especially suited for waiting areas.

ES 104

	Article no.	without VAT in SEK*	with VAT in SEK*
swivel	412 207 00		
with armrests			
Leather L20		68.400,00	85.500,00
Leather L50		73.600,00	92.000,00

Leather L20

Leather

Leather L50

Leather Premium F

Castors

02 castors hard, braked for carpet
 03 castors soft, braked for hard floor

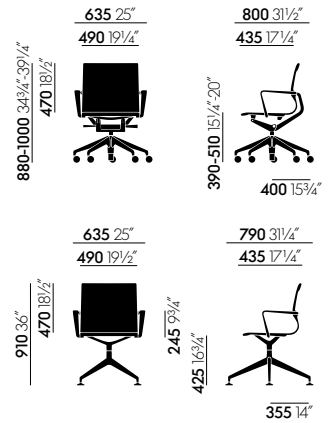

All measurements are pursuant to EN 1335-1:2000
More detailed information is found in the chapter 'Explanation of measurements'.

Office swivel chair in accordance with EN 1335.

Mechanical unit and back braces: powder-coated aluminium in deep black (RAL 9005) or soft grey (RAL 7047). With synchronised movement, individual adjustment of backrest resistance and locking device in upright position. Seat height continuously adjustable via gas spring.

Frame, seat and back: flexible frame and armrests in polyamide (deep black or soft grey). One-piece sling panel for the seat and back in TrioKnit knitted fabric or FleeceNet woven fabric.

Base: five-star base in die-cast aluminium, with a polished finish or powder-coated in deep black or soft grey.

Conference chair (swivel) in accordance with EN 16139.

Frame, seat and back: flexible frame and armrests in polyamide (deep black or soft grey). One-piece sling panel for the seat and back in TrioKnit knitted fabric or FleeceNet woven fabric.

Base: four-star base in die-cast aluminium, with a polished finish or powder-coated in deep black or soft grey.

Physix	Article no.	without VAT in SEK*	with VAT in SEK*
Five-star base	417 210 00		
aluminium base deep black, TrioKnit	01	10.272,00	12.840,00
aluminium base soft grey, TrioKnit	11	10.272,00	12.840,00
aluminium base polished, TrioKnit	21	10.272,00	12.840,00
aluminium base deep black, FleeceNet	03	9.528,00	11.910,00
aluminium base soft grey, FleeceNet	13	9.528,00	11.910,00
aluminium base polished, FleeceNet	23	9.528,00	11.910,00

Physix Conference	Article no.	without VAT in SEK*	with VAT in SEK*
Four-star base	417 211 00		
aluminium base deep black, TrioKnit	01	8.936,00	11.170,00
aluminium base soft grey, TrioKnit	11	8.936,00	11.170,00
aluminium base polished, TrioKnit	21	8.936,00	11.170,00
aluminium base deep black, FleeceNet	03	8.176,00	10.220,00
aluminium base soft grey, FleeceNet	13	8.176,00	10.220,00
aluminium base polished, FleeceNet	23	8.176,00	10.220,00

 Quickship

Physix, cover material TrioKnit, black pearl	Article no.	without VAT in SEK*	with VAT in SEK*
Hard braked castors for carpet	QS1 721 0A	10.272,00	12.840,00
Five-star aluminium base in deep black, frame and mechanical unit in deep black			
Soft braked castors for hard floors	QS1 721 0B	10.272,00	12.840,00
Five-star aluminium base in deep black, frame and mechanical unit in deep black			

 Quickship

Physix, cover material TrioKnit, silver grey	Article no.	without VAT in SEK*	with VAT in SEK*
Hard braked castors for carpet	QS1 721 0E	10.272,00	12.840,00
Five-star aluminium base in soft grey, frame and mechanical unit in soft grey			
Soft braked castors for hard floors	QS1 721 0F	10.272,00	12.840,00
Five-star aluminium base in soft grey, frame and mechanical unit in soft grey			

FleeceNet	TrioKnit	Frame	Castors	Glides
01 black	03 reed	12 deep black	02 castors hard, braked for carpet	04 glides for carpet
03 ice grey	06 black pearl	53 soft grey	03 castors soft, braked for hard floor	05 felt glides for hard floor
07 soft grey	07 silver grey			
08 mid-grey	08 pebble grey			
	09 ice grey			
	10 brick			

Physix Studio

Alberto Meda, 2017

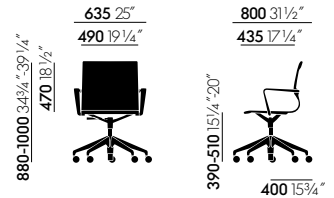

All measurements are pursuant to EN 1335-1:2000
More detailed information is found in the chapter 'Explanation of measurements'.

Studio chair (swivel) in accordance with DIN 68877.

Frame, seat and back: flexible frame and armrests in polyamide (deep black or soft grey). One-piece sling panel for the seat and back in TrioKnit knitted fabric or FleeceNet woven fabric. Continuous seat height adjustment with gas spring.

Base: five-star base in die-cast aluminium, with a polished finish or powder-coated in deep black or soft grey.

Physix Studio

	Article no.	without VAT in SEK*	with VAT in SEK*
Five-star base		417 212 00	
aluminium base deep black, TrioKnit	01	9.632,00	12.040,00
aluminium base soft grey, TrioKnit	11	9.632,00	12.040,00
aluminium base polished, TrioKnit	21	9.632,00	12.040,00
aluminium base deep black, FleeceNet	03	8.832,00	11.040,00
aluminium base soft grey, FleeceNet	13	8.832,00	11.040,00
aluminium base polished, FleeceNet	23	8.832,00	11.040,00

FleeceNet

01 black
03 ice grey
07 soft grey
08 mid-grey

TrioKnit

03 reed
06 black pearl
07 silver grey
08 pebble grey
09 ice grey
10 brick

Frame

12 deep black
53 soft grey

Castors

02 castors hard, braked for carpet
03 castors soft, braked for hard floor

Pivot

Antonio Citterio, 2012

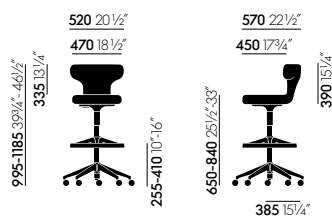

Pivot High Stool

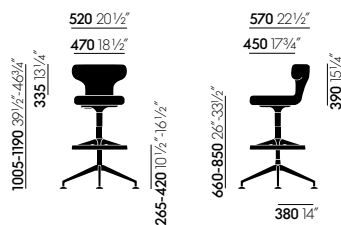

Pivot Counter Stool

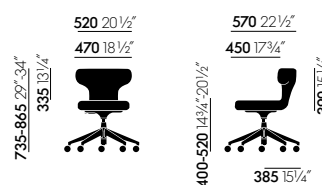

Pivot Stool

All measurements are pursuant to EN 1335-1:2000
 More detailed information is found in the chapter 'Explanation of measurements'.

Seat and back shell: one-piece seat and back shell made of polypropylene and encased in polyurethane foam, covered with SingleKnit fabric.

Pivot High Stool: tall task chair in accordance with DIN 68877. Five-star base in polyamide (basic dark) or polished die-cast aluminium with reverse-brake castors. Adjustable seat height. Fitted with height-adjustable polyamide foot ring with anti-skid finish. Adjustment ring for foot ring height is always in the colour soft green.

Pivot Counter Stool: tall visitor chair in accordance with EN 16139. Four-star base in polished die-cast aluminium on glides. Adjustable seat height. Also fitted with height-adjustable polyamide foot ring with anti-skid finish. Adjustment ring for foot ring height is always in the colour soft green.

Pivot Stool: work chair in accordance with DIN 68877. Without foot ring in normal swivel chair height. Adjustable seat height. Five-star base in polyamide (basic dark) or polished die-cast aluminium, with double castors (Ø 60 mm) or glides.

Pivot

Antonio Citterio, 2012



Pivot High Stool	Article no.	without VAT in SEK*	with VAT in SEK*
Five-star base	421 010 00		
base plastic basic dark, SingleKnit	01	10.736,00	13.420,00
base polished aluminium, SingleKnit	11	12.408,00	15.510,00

Pivot Counter Stool	Article no.	without VAT in SEK*	with VAT in SEK*
Four-star base	421 011 00		
base polished aluminium, SingleKnit	11	12.408,00	15.510,00

Pivot Stool	Article no.	without VAT in SEK*	with VAT in SEK*
Five-star base	421 012 00		
base plastic basic dark, SingleKnit	01	8.376,00	10.470,00
base polished aluminium, SingleKnit	11	10.048,00	12.560,00

Knit	Castors (Pivot High Stool)	Castors (Pivot Stool)	Glides (Pivot Counter Stool)
. SingleKnit	06 castors inversely braked	02 castors hard, braked for carpet 03 castors soft, braked for hard floor	04 glides for carpet 05 felt glides for hard floor

Rookie

Konstantin Grcic, 2018

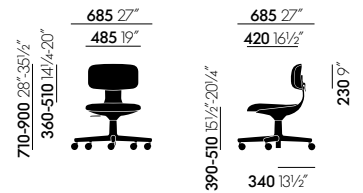

All measurements are pursuant to EN 1335-1:2000
More detailed information is found in the chapter 'Explanation of measurements'.

Studio chair (swivel, height-adjustable) in accordance with EN 16139.

Backrest: back made of polypropylene and back cushion made of polyurethane foam. Back shell in soft grey or deep black; back cushion with fabric or leather cover stretched over padding. Backrest height adjustable up to 55 mm using a quick release lever.

Seat: polypropylene shell in soft grey or deep black; polyurethane foam cushion; fabric or leather cover stretched over padding. Equipped as standard with seat height adjustment.

Base: five-star base made of polyamide in soft grey or deep black; double castors (Ø 60 mm) in basic dark.

Rookie	Article no.	without VAT in SEK*	with VAT in SEK*
	419 011 00		
Fabric F30		4.408,00	5.510,00
Fabric F60		4.536,00	5.670,00
Fabric F80		4.688,00	5.860,00
Leather L20		7.984,00	9.980,00



Rookie, cover material Plano, nero	Article no.	without VAT in SEK*	with VAT in SEK*
Hard braked castors for carpet	Shell colour deep black, five-star plastic base in deep black QS1 901 1B	4.408,00	5.510,00
Soft braked castors for hard floors	Shell colour deep black, five-star plastic base in deep black QS1 901 1A	4.408,00	5.510,00



Rookie, cover material Plano, cream white/sierra grey	Article no.	without VAT in SEK*	with VAT in SEK*
Hard braked castors for carpet	Shell colour soft grey, five-star plastic base in soft grey QS1 901 1D	4.408,00	5.510,00
Soft braked castors for hard floors	Shell colour soft grey, five-star plastic base in soft grey QS1 901 1C	4.408,00	5.510,00

Fabric F30	Fabric F60	Fabric F80	Leather L20	Base and frame	Castors
. Plano	. Twill . Volo	. Tress	. Leather	12 deep black 53 soft grey	02 castors hard, braked for carpet 03 castors soft, braked for hard floor

Rookie High

Konstantin Grcic, 2018

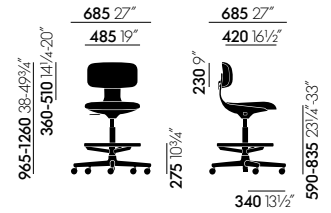

All measurements are pursuant to EN 1335-1:2000
More detailed information is found in the chapter 'Explanation of measurements'.

Counter stool in accordance with EN 16139.

Backrest: back made of polypropylene and back cushion of polyurethane foam. Back shell in soft grey or deep black; back cushion with fabric or leather cover stretched over padding. Backrest height adjustable up to 55 mm using a quick release lever.

Seat: polypropylene shell in soft grey or deep black; polyurethane foam cushion; fabric or leather cover stretched over padding. Equipped as standard with seat height adjustment.

Foot ring: equipped with height-adjustable steel foot ring, powder-coated in deep black with anti-skid finish, or chrome-plated.

Base: five-star base made of polyamide in soft grey or deep black; reverse brake castors (Ø 60 mm) in basic dark.

Rookie High

	Article no.	without VAT in SEK*	with VAT in SEK*
	419 012 00		
Fabric F30		7.832,00	9.790,00
Fabric F60		7.976,00	9.970,00
Fabric F80		8.120,00	10.150,00
Leather L20		11.416,00	14.270,00
Footrest			
powder-coated in deep black	1	0,00	0,00
chromed	2	760,00	950,00

Fabric F30	Fabric F60	Fabric F80	Leather L20	Base and frame	Castors
. Plano	. Twill . Volo	. Tress	. Leather	12 deep black 53 soft grey	06 castors inversely braked

Softshell Chair

Ronan & Erwan Bouroullec, 2008

vitra.

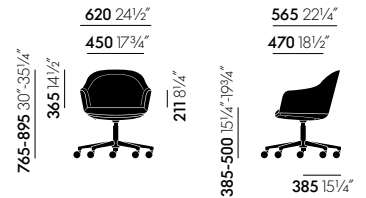

All measurements are pursuant to EN 1335-1:2000
More detailed information is found in the chapter 'Explanation of measurements'.

Backrest and seat: flexible upper backrest shell. Seat and backrest shell in fibreglass-reinforced polyamide. Seat and backrest upholstery in polyurethane foam. Armrests are integrated in the seat shell. With two seams along the sides of the backrest.

Five-star base: powder-coated (basic dark) or polished aluminium.

Softshell Chair

	Article no.	without VAT in SEK*	with VAT in SEK*
Five-star base	423 008 00		
Fabric F30		10.080,00	12.600,00
Fabric F40		10.240,00	12.800,00
Fabric F60		10.720,00	13.400,00
Fabric F80		11.280,00	14.100,00
Fabric F100		12.000,00	15.000,00
Fabric F120		12.560,00	15.700,00
Leather L20		17.680,00	22.100,00
Leather L50		21.440,00	26.800,00
Surcharges base			
aluminium base, powder-coated in basic dark	2	0,00	0,00
aluminium base, polished	3	456,00	570,00

Fabric F30	Fabric F40	Fabric F60	Fabric F80	Fabric F100	Fabric F120	Leather L20	Leather L50	Castors
Plano	Laser RE	Twill Volo	Dumet Linho Tress	Aura Reed	Credo	Leather	Leather Premium F	02 castors hard, braked for carpet 03 castors soft, braked for hard floor

Unix Chair

Antonio Citterio, 2010



Four-star base



Five-star base

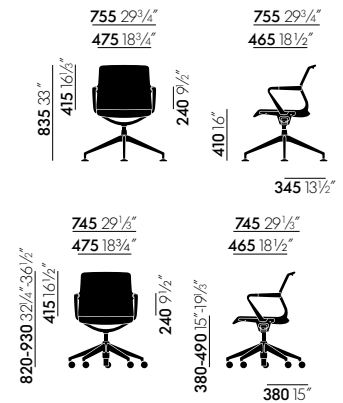

All measurements are pursuant to EN 1335-1:2000
 More detailed information is found in the chapter 'Explanation of measurements'.

Seat frame and armrest sleeves: monochrome polypropylene in basic dark or soft grey.

Seat and back cover: Plano fabric or one of the 3D spacer fabrics Diamond Mesh (mesh look) or Silk Mesh (solid look). For Silk Mesh in the colour soft grey, the reverse side is in soft grey. For Silk Mesh in the colours nero and asphalt, the reverse side is in nero. For Silk Mesh in the colours olive green, smoke blue and dim grey, the reverse side matches the frame colour (soft grey or nero).

Five-star base: polished die-cast aluminium with double castors (Ø 60 mm). Swivel mechanism, height adjustable.

Four-star base: polished die-cast aluminium on glides. Swivel mechanism with vertical spring suspension for added comfort.

Unix Chair

	Article no.	without VAT in SEK*	with VAT in SEK*
Four-star base	431 205 00		
Silk Mesh		8.576,00	10.720,00
Diamond Mesh		8.576,00	10.720,00
Fabric F30		8.576,00	10.720,00

Unix Chair

	Article no.	without VAT in SEK*	with VAT in SEK*
Five-star base	431 206 00		
Silk Mesh		9.408,00	11.760,00
Diamond Mesh		9.408,00	11.760,00
Fabric F30		9.408,00	11.760,00

Fabric F30	Frame	Castors/Glides
Plano	30 basic dark 53 soft grey	02 castors hard, braked for carpet 03 castors soft, braked for hard floor 04 glides for carpet 05 felt glides for hard floor

Chairs



.03
Maarten Van Severen
56



.05
Maarten Van Severen
58



AC 5 Meet
Antonio Citterio
59



EA101/103/104
Charles & Ray Eames
61



EA 105/107/108
Charles & Ray Eames
63



EA 205/207/208
Charles & Ray Eames
65



APC
Jasper Morrison
72



Belleville Chair
R & E Bouroullec
73



Chaise Tout Bois
Jean Prouvé
75



DAR Fiberglass
Charles & Ray Eames
76



DAW Fiberglass
Charles & Ray Eames
76



DAX Fiberglass
Charles & Ray Eames
76



LAR Fiberglass
Charles & Ray Eames
78



DSR Fiberglass
Charles & Ray Eames
80



DSW Fiberglass
Charles & Ray Eames
82



DSX Fiberglass
Charles & Ray Eames
84



LSR Fiberglass
Charles & Ray Eames
85



DAR
Charles & Ray Eames
86



DAW
Charles & Ray Eames
86



DAL
Charles & Ray Eames
89



DAX
Charles & Ray Eames
89



LAR
Charles & Ray Eames
92



DSR
Charles & Ray Eames
94



DSW
Charles & Ray Eames
96



DSX
Charles & Ray Eames
98



LSR
Charles & Ray Eames
99



DSS
Charles & Ray Eames
100



DSS-N
Charles & Ray Eames
102



EVO-C
Jasper Morrison
104



Fauteuil Direction
Jean Prouvé
105



HAL RE Wood
Jasper Morrison
106



HAL Ply Wood
Jasper Morrison
106



HAL RE Tube
Jasper Morrison
108



HAL Ply Tube
Jasper Morrison
108



HAL RE Tube Armrest
Jasper Morrison
113

Office and conference chairs (swivel)



HAL Tube Writing Tablet
Jasper Morrison
113



HAL RE Cantilever
Jasper Morrison
115



HAL RE Sledge
Jasper Morrison
115

Chairs



Tables



HAL RE Armchair Wood
Jasper Morrison
117



HAL RE Armchair Tube
Jasper Morrison
117



HAL Soft Wood
Jasper Morrison
110

Desks

Public waiting areas



HAL Soft Tube
Jasper Morrison
111



HAL Soft Tube Stackable
Jasper Morrison
112



HAL RE Stool Medium,
HAL RE Stool High
Jasper Morrison
119

Lounge chairs and armchairs

Sofas



HAL Ply Stool Medium,
HAL Ply Stool High
Jasper Morrison
119



HAL RE Barstool
Jasper Morrison
121



ID Visitor Air
Antonio Citterio
124

Coffee and side tables

Stools and benches



ID Visitor Mesh
Antonio Citterio
124



ID Visitor Soft
Antonio Citterio
126



ID Visitor Trim
Antonio Citterio
126

Storage and partition elements

Accessories

Living, dining, decorative objects, home office,
clocks, lighting, publications



Landi Chair
Hans Coray
128



Lobby Chair ES 105
Charles & Ray Eames
129



Lobby Chair ES 108
Charles & Ray Eames
129

Quick Ship programme

General terms, conditions
and information

Chairs



Moca
Jasper Morrison
130



MedaSlim
Alberto Meda
131



Organic Chair
Charles Eames &
Eero Saarinen
133



Organic Conference
Charles Eames &
Eero Saarinen
134



Panton Chair Classic
Verner Panton
135



Panton Chair
Verner Panton
136



Panton Junior
Verner Panton
137



DCM
Charles & Ray Eames
138



DCW
Charles & Ray Eames
138



Softshell Chair
R & E Bouroullec
141



Softshell Side Chair
R & E Bouroullec
143



Standard
Jean Prouvé
144



Standard SP
Jean Prouvé
145



Stool-Tool
Konstantin Grcic
146



Tabouret Haut
Jean Prouvé
147



Tip Ton
Barber & Osgerby
148



Tip Ton RE
Barber & Osgerby
149



Unix Chair
Antonio Citterio
151



Unix Chair
Antonio Citterio
152



Wiggle Side Chair
Frank Gehry
153



DKR, DKR-2, DKR-5
Charles & Ray Eames
154



DKW, DKW-2, DKW-5
Charles & Ray Eames
156



DKX, DKX-2, DKX-5
Charles & Ray Eames
157



LKR, LKR-2, LKR-5
Charles & Ray Eames
158

Other products in this chapter

(This chapter presents all of the products belonging to a single product family, regardless of their field of application.)



AC 5 Studio
Antonio Citterio
60



EA 117/118/119
Charles & Ray Eames
67



EA 217/219
Charles & Ray Eames
69



EA 124/125
Charles & Ray Eames
70



EA 222/223
Charles & Ray Eames
71



RAR Fiberglass
Charles & Ray Eames
79



PACC
Charles & Ray Eames
91



RAR
Charles & Ray Eames
93



PSCC
Charles & Ray Eames
103



HAL RE Armchair Studio
Jasper Morrison
117



HAL RE Studio
Jasper Morrison
117



LCM
Charles & Ray Eames
129

Office and conference chairs (swivel)



Chairs

Tables

Desks

Public waiting areas

Lounge chairs and armchairs

Sofas

Coffee and side tables

Stools and benches

Storage and partition elements

Accessories

Living, dining, decorative objects, home office, clocks, lighting, publications

Quick Ship programme

General terms, conditions and information



LCW
Charles & Ray Eames
130



Softshell Chair
R & E Bouroullec
142



Unix Chair
Antonio Citterio
150



Wiggle Stool
Frank Gehry
153

.03

Maarten Van Severen, 1998

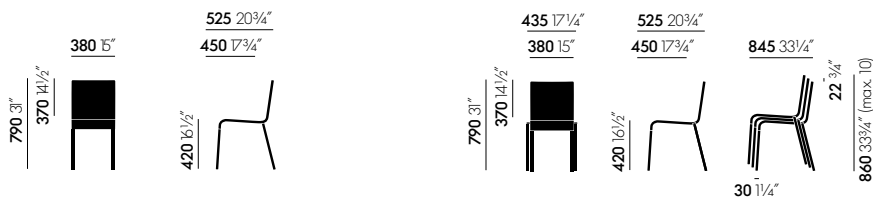

All measurements are pursuant to EN 1335-1:2000
 More detailed information is found in the chapter 'Explanation of measurements'.

Seat shell: integral skin polyurethane foam. Shell with upholstered effect, self-supporting on a tubular steel frame. Flexible backrest with integrated leaf springs.

Base/stackability: back legs in tubular steel, front legs in aluminium profile, powder-coated or chrome-plated. Stacking and non-stacking versions. Up to 10 chairs can be stacked on the floor, up to 20 chairs on a stacking trolley. Fitted with plastic glides for carpet or felt glides for hard floors.

Maarten Van Severen, 1998

.03	Article no.	without VAT in SEK*	with VAT in SEK*
non-stacking	440 426 00		
Base powder-coated in black	55	5.912,00	7.390,00
Base powder-coated in silver, smooth finish	16	5.912,00	7.390,00
Base chrome-plated	01	6.392,00	7.990,00
stacking	440 427 00		
Base powder-coated in black	55	6.160,00	7.700,00
Base powder-coated in silver, smooth finish	16	6.160,00	7.700,00
Base chrome-plated	01	6.600,00	8.250,00

Stacking dolly	Article no.	without VAT in SEK*	with VAT in SEK*
Suitable for up to 20 chairs	442 040 00	12.880,00	16.100,00

End connectors	Article no.	without VAT in SEK*	with VAT in SEK*	
plastic	basic dark	442 042 00	144,00	180,00

End cap	Article no.	without VAT in SEK*	with VAT in SEK*
Plastic element for numbering the row of chairs	442 043 00	128,00	160,00

Number clips	Article no.	without VAT in SEK*	with VAT in SEK*
Set of 10 items	442 044 00		
	01	176,00	220,00

Seat shell	Glides	Number clips
01 basic dark	04 glides for carpet	01 numbers (1 set 1-10)
10 bright red	05 felt glides for hard floor	02 numbers (1 set 11-20)
77 dark green		03 numbers (1 set 21-30)
78 mango		04 numbers (1 set 31-40)
		05 numbers (1 set 41-50)

.05

Maarten Van Severen, 2004

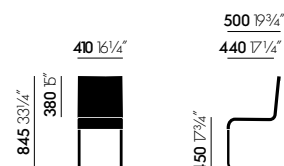

All measurements are pursuant to EN 1335-1:2000
More detailed information is found in the chapter 'Explanation of measurements'.

Seat shell: cantilever chair with seat shell made of integral skin polyurethane foam. Shell with upholstered effect, self-supporting on a tubular stainless steel frame. Flexible backrest with integrated leaf springs.

Base: stackable (max. 5 chairs) or non-stackable base in stainless steel with satin finish or powder coating. Fitted with plastic glides for carpet or felt glides for hard floors.

Use: suited for outdoor use.

Note: special additives retard the fading of colours due to UV radiation. However, if the chair is exposed to sunlight for prolonged periods, the colour may change over time. We recommend limited exposure to sunlight.

.05	Article no.	without VAT in SEK*	with VAT in SEK*
non-stacking	440 121 00		
Base stainless steel, suitable for outdoor use	01	6.920,00	8.650,00
Base powder-coated in black, suitable for outdoor use	55	6.920,00	8.650,00
stacking	440 122 00		
Base stainless steel, suitable for outdoor use	01	7.480,00	9.350,00
Base powder-coated in black, suitable for outdoor use	55	7.480,00	9.350,00

Seat shell

01 basic dark
10 bright red
77 dark green

Glides

04 glides for carpet
05 felt glides for hard floor

AC 5 Meet

Antonio Citterio, 2017

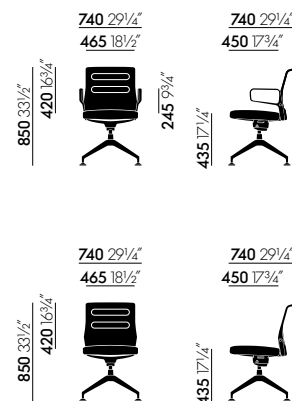

All measurements are pursuant to EN 1335-1:2000
More detailed information is found in the chapter 'Explanation of measurements'.

Conference chair (swivel) in accordance with EN 16139.

Seat mechanism: tilt mechanism, lockable in upright position. Mechanism housing in polished aluminium.

Backrest: self-supporting backrest construction with horizontally stitched padding. Cover in fabric or leather.

Seat: polyurethane foam padding. Cover in fabric or leather.

Armrests: without armrests or with polished die-cast aluminium ring armrests, optional leather pads (pads are matched to the leather upholstery; for chairs with fabric covers, the leather armrest pads are in the colour nero).

Base: four-star base in polished die-cast aluminium on glides. Swivel mount with shock-absorbing seat suspension.

AC 5 Meet	Article no.	without VAT in SEK*	with VAT in SEK*
four-star base	421 021 00		
Fabric F30		9.424,00	11.780,00
Fabric F60		9.976,00	12.470,00
Leather L20		16.584,00	20.730,00
Surcharges armrests			
without armrests	11	0,00	0,00
aluminium ring armrests	14	2.224,00	2.780,00
leather-covered aluminium ring armrest	15	3.000,00	3.750,00

Fabric F30	Fabric F60	Leather L20	Glides
. Plano	. Hopsak . Twill	. Leather	04 glides for carpet 05 felt glides for hard floor

AC 5 Studio

Antonio Citterio, 2017

vitra.

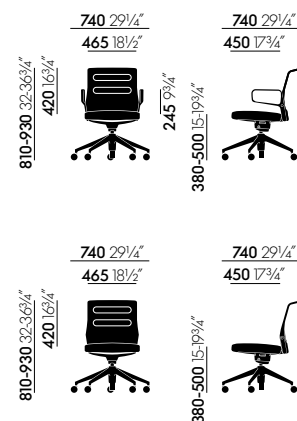

All measurements are pursuant to EN 1335-1:2000
More detailed information is found in the chapter 'Explanation of measurements'.

Studio chair (swivel, height-adjustable) in accordance with EN 16139.

Seat mechanism: tilt mechanism, lockable in upright position. Mechanism housing in polished aluminium.

Backrest: self-supporting backrest construction with horizontally stitched padding. Cover in fabric or leather.

Seat: polyurethane foam padding. Cover in fabric or leather.

Armrests: without armrests or with polished die-cast aluminium ring armrests, optional leather pads (pads are matched to the leather upholstery; for chairs with fabric covers, the leather armrest pads are in the colour nero).

Base: five-star base in polished die-cast aluminium or plastic (basic dark) on double castors (Ø 60 mm). Swivel mount, height adjustable.

AC 5 Studio

	Article no.	without VAT in SEK*	with VAT in SEK*
five-star base	421 020 00		
Fabric F30		7.832,00	9.790,00
Fabric F60		8.384,00	10.480,00
Leather L20		14.992,00	18.740,00
Surcharges armrests			
without armrests	11	0,00	0,00
aluminium ring armrests	14	2.224,00	2.780,00
leather-covered aluminium ring armrest	15	3.000,00	3.750,00
Surcharges base			
plastic basic dark	0	0,00	0,00
polished aluminium	1	1.592,00	1.990,00

Fabric F30	Fabric F60	Leather L20	Castors
. Plano	. Hopsak . Twill	. Leather	02 castors hard, braked for carpet 03 castors soft, braked for hard floor

Aluminium Chairs EA 101/103/104

Charles & Ray Eames, 1958

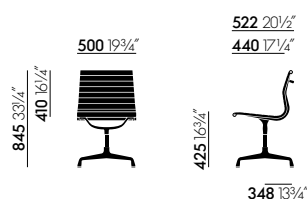

EA 101

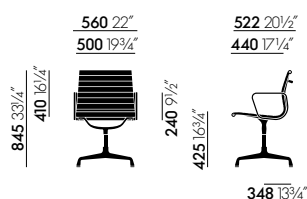

EA 103

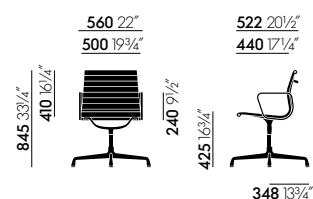

EA 104

All measurements are pursuant to EN 1335-1:2000

More detailed information is found in the chapter 'Explanation of measurements'.

Backrest and seat: chair with medium-height backrest; for table seating. Seat in mesh fabric or upholstered with high-frequency welded horizontal ribbing in fabric or leather. Side profiles and spreaders in die-cast aluminium, with a polished or chrome-plated finish or powder-coated in deep black.

Armrests: die-cast aluminium, with a polished or chrome-plated finish or powder-coated in deep black.

Base: four-star base in die-cast aluminium, with a polished or chrome-plated finish or powder-coated in deep black.

Aluminium Chairs EA 101/103/104

Charles & Ray Eames, 1958

vitra.

EA 101	Article no.	without VAT in SEK*	with VAT in SEK*
non-swivel	412 321 00		
without armrests			
Netweave		16.400,00	20.500,00
Fabric F60		16.400,00	20.500,00
Leather L20		22.080,00	27.600,00
Leather L50		26.560,00	33.200,00
Surcharges base			
polished	1	0,00	0,00
powder-coated in deep black	4	0,00	0,00
chromed	0	1.520,00	1.900,00

EA 103	Article no.	without VAT in SEK*	with VAT in SEK*
non-swivel	412 323 00		
with armrests			
Netweave		18.480,00	23.100,00
Fabric F60		18.480,00	23.100,00
Leather L20		24.160,00	30.200,00
Leather L50		28.640,00	35.800,00
Surcharges base			
polished	1	0,00	0,00
powder-coated in deep black	4	0,00	0,00
chromed	0	1.680,00	2.100,00

EA 104	Article no.	without VAT in SEK*	with VAT in SEK*
swivel	412 324 00		
with armrests			
Netweave		18.480,00	23.100,00
Fabric F60		18.480,00	23.100,00
Leather L20		24.160,00	30.200,00
Leather L50		28.640,00	35.800,00
Surcharges base			
polished	1	0,00	0,00
powder-coated in deep black	4	0,00	0,00
chromed	0	1.680,00	2.100,00

Fabric F60	Leather L20	Leather L50	Glides
. Hopsak	. Leather/back panel Plano	. Leather Premium F/back panel Plano	04 glides for carpet 05 felt glides for hard floor

Aluminium Chairs EA 105/107/108

Charles & Ray Eames, 1958

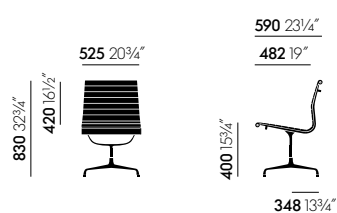

EA 105

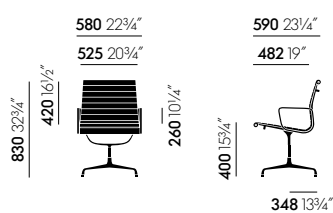

EA 107

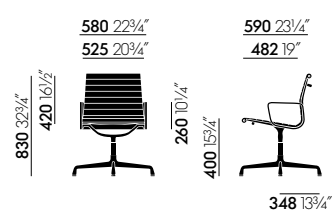

EA 108

All measurements are pursuant to EN 1335-1:2000

More detailed information is found in the chapter 'Explanation of measurements'.

Backrest and seat: chair with medium-high backrest. Seat in mesh fabric or upholstered with high-frequency welded horizontal ribbing in fabric or leather. Side profiles and spreaders in die-cast aluminium, with a polished or chrome-plated finish or powder-coated in deep black.

Armrests: die-cast aluminium, with a polished or chrome-plated finish or powder-coated in deep black.

Base: four-star base in die-cast aluminium, with a polished or chrome-plated finish or powder-coated in deep black.

Aluminium Chairs EA 105/107/108

Charles & Ray Eames, 1958

vitra.

EA 105	Article no.	without VAT in SEK*	with VAT in SEK*
non-swivel	412 358 00		
without armrests			
Netweave		19.040,00	23.800,00
Fabric F60		19.040,00	23.800,00
Leather L20		25.440,00	31.800,00
Leather L50		30.560,00	38.200,00
Surcharges base			
polished	1	0,00	0,00
powder-coated in deep black	4	0,00	0,00
chromed	0	1.872,00	2.340,00

EA 107	Article no.	without VAT in SEK*	with VAT in SEK*
non-swivel	412 360 00		
with armrests			
Netweave		21.120,00	26.400,00
Fabric F60		21.120,00	26.400,00
Leather L20		27.520,00	34.400,00
Leather L50		32.640,00	40.800,00
Surcharges base			
polished	1	0,00	0,00
powder-coated in deep black	4	0,00	0,00
chromed	0	2.032,00	2.540,00

EA 108	Article no.	without VAT in SEK*	with VAT in SEK*
swivel	412 361 00		
with armrests			
Netweave		21.120,00	26.400,00
Fabric F60		21.120,00	26.400,00
Leather L20		27.520,00	34.400,00
Leather L50		32.640,00	40.800,00
Surcharges base			
polished	1	0,00	0,00
powder-coated in deep black	4	0,00	0,00
chromed	0	2.032,00	2.540,00

Fabric F60	Leather L20	Leather L50	Glides
. Hopsak	. Leather/back panel Plano	. Leather Premium F/back panel Plano	04 glides for carpet 05 felt glides for hard floor

Soft Pad Chairs EA 205/207/208

Charles & Ray Eames, 1969

vitra.

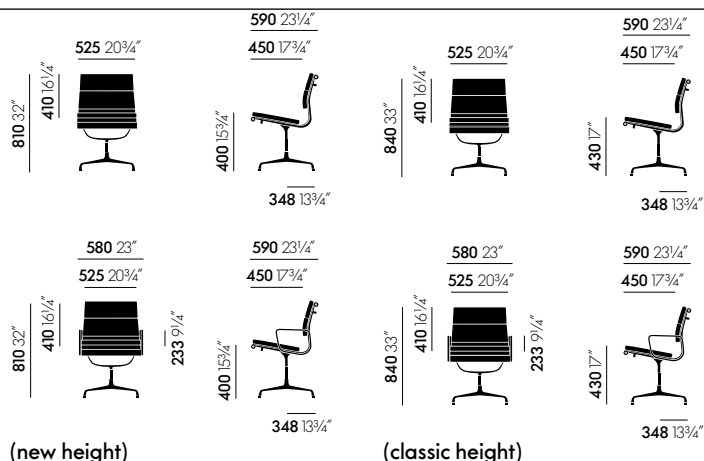

EA 208

All measurements are pursuant to EN 1335-1:2000
More detailed information is found in the chapter 'Explanation of measurements'.

Backrest and seat: chair with medium-high backrest. Three sewn-on cushions with polyurethane foam upholstery in leather. Side profiles and spreaders in die-cast aluminium, with a polished or chrome-plated finish or powder-coated in deep black.

Armrests: die-cast aluminium, with a polished or chrome-plated finish or powder-coated in deep black.

Base: four-star base in die-cast aluminium, with a polished or chrome-plated finish or powder-coated in deep black. Available in two different heights.

EA 205 (new height)

	Article no.	without VAT in SEK*	with VAT in SEK*
non-swivel	412 325 00		
without armrests			
Leather L20		27.760,00	34.700,00
Leather L50		33.360,00	41.700,00
Surcharges base			
polished	1	0,00	0,00
powder-coated in deep black	4	0,00	0,00
chromed	0	1.872,00	2.340,00

EA 207 (new height)

	Article no.	without VAT in SEK*	with VAT in SEK*
non-swivel	412 327 00		
with armrests			
Leather L20		29.840,00	37.300,00
Leather L50		35.440,00	44.300,00
Surcharges base			
polished	1	0,00	0,00
powder-coated in deep black	4	0,00	0,00
chromed	0	2.032,00	2.540,00

EA 208 (new height)

	Article no.	without VAT in SEK*	with VAT in SEK*
swivel	412 328 00		
with armrests			
Leather L20		29.840,00	37.300,00
Leather L50		35.440,00	44.300,00
Surcharges base			
polished	1	0,00	0,00
powder-coated in deep black	4	0,00	0,00
chromed	0	2.032,00	2.540,00

Soft Pad Chairs EA 205/207/208

Charles & Ray Eames, 1969

vitra.

EA 205 (classic height)	Article no.	without VAT in SEK*	with VAT in SEK*
non-swivel			
	412 375 00		
without armrests			
Leather L20		27.760,00	34.700,00
Leather L50		33.360,00	41.700,00
Surcharges base			
polished	1	0,00	0,00
powder-coated in deep black	4	0,00	0,00
chromed	0	1.872,00	2.340,00

EA 207 (classic height)	Article no.	without VAT in SEK*	with VAT in SEK*
non-swivel			
	412 377 00		
with armrests			
Leather L20		29.840,00	37.300,00
Leather L50		35.440,00	44.300,00
Surcharges base			
polished	1	0,00	0,00
powder-coated in deep black	4	0,00	0,00
chromed	0	2.032,00	2.540,00

EA 208 (classic height)	Article no.	without VAT in SEK*	with VAT in SEK*
swivel			
	412 378 00		
with armrests			
Leather L20		29.840,00	37.300,00
Leather L50		35.440,00	44.300,00
Surcharges base			
polished	1	0,00	0,00
powder-coated in deep black	4	0,00	0,00
chromed	0	2.032,00	2.540,00

Leather L20

Leather/back panel Plano

Leather L50

Leather Premium F (contrast seam)/back panel Plano

Glides

04 glides for carpet
05 felt glides for hard floor

Aluminium Chairs EA 117/118/119

Charles & Ray Eames, 1958



EA 117



EA 118



EA 119

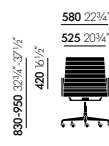

EA 117

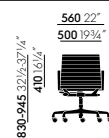
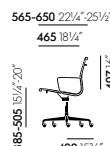

EA 118

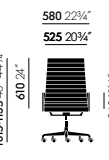
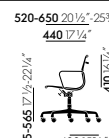

EA 119



All measurements are pursuant to EN 1335-1:2000

More detailed information is found in the chapter 'Explanation of measurements'.

Backrest and seat: EA 117 with medium-height backrest; EA 118 with medium-height backrest and table-oriented sitting position; EA 119 with high backrest. High-frequency welded horizontal ribbing in fabric or leather. Side profiles and spreaders in die-cast aluminium, with a polished or chrome-plated finish or powder-coated in deep black.

Seat mechanism: adjustable backward tilt, lockable in the forward position. Continuous seat height adjustment with gas spring.

Armrests: die-cast aluminium, with a polished or chrome-plated finish or powder-coated in deep black.

Base: five-star base in die-cast aluminium, with a polished or chrome-plated finish or powder-coated in deep black. Equipped with hard castors for carpet or soft castors for hard floors. Castor covers in black for polished and black base, with chrome-plated finish for chrome base.

Aluminium Chairs EA 117/118/119

Charles & Ray Eames, 1958

vitra.

EA 117	Article no.	without VAT in SEK*	with VAT in SEK*
medium-high backrest, swivel	412 364 00		
with armrests			
Fabric F60		26.080,00	32.600,00
Leather L20		32.400,00	40.500,00
Leather L50		37.200,00	46.500,00
Surcharges base			
polished	1	0,00	0,00
powder-coated in deep black	4	0,00	0,00
chromed	0	2.032,00	2.540,00

EA 118	Article no.	without VAT in SEK*	with VAT in SEK*
medium-high backrest, swivel	412 329 00		
with armrests			
Fabric F60		23.680,00	29.600,00
Leather L20		29.360,00	36.700,00
Leather L50		34.000,00	42.500,00
Surcharges base			
polished	1	0,00	0,00
powder-coated in deep black	4	0,00	0,00
chromed	0	2.032,00	2.540,00

EA 119	Article no.	without VAT in SEK*	with VAT in SEK*
high backrest, swivel	412 365 00		
with armrests			
Fabric F60		31.840,00	39.800,00
Leather L20		38.960,00	48.700,00
Leather L50		44.320,00	55.400,00
Surcharges base			
polished	1	0,00	0,00
powder-coated in deep black	4	0,00	0,00
chromed	0	2.920,00	3.650,00

Fabric F60	Leather L20	Leather L50	Castors
. Hopsak	. Leather/back panel Plano	. Leather Premium F/back panel Plano	02 castors hard, braked for carpet 03 castors soft, braked for hard floor

Soft Pad Chairs EA 217/219

Charles & Ray Eames, 1969

vitra.



EA 217



EA 219

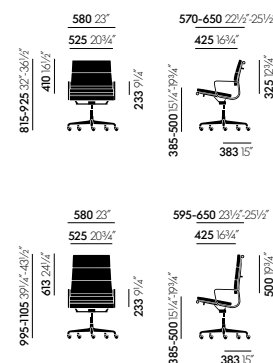

All measurements are pursuant to EN 1335-1:2000
More detailed information is found in the chapter 'Explanation of measurements'.

Backrest and seat: EA 217 with medium-high backrest, EA 219 with high backrest. Sewn-on cushions with polyurethane foam upholstery in leather. Side profiles and spreaders in die-cast aluminium, with a polished or chrome-plated finish or powder-coated in deep black.

Seat mechanism: adjustable backward tilt, lockable in the forward position. Continuous seat height adjustment with gas spring.

Armrests: die-cast aluminium, with a polished or chrome-plated finish or powder-coated in deep black.

Base: five-star base in die-cast aluminium, with a polished or chrome-plated finish or powder-coated in deep black. Equipped with hard castors for carpet or soft castors for hard floors. Castor covers in black for polished and black powder-coated base, with chrome-plated finish for chrome base.

EA 217	Article no.	without VAT in SEK*	with VAT in SEK*
medium-high backrest, swivel	412 381 00		
with armrests			
Leather L20		34.400,00	43.000,00
Leather L50		40.240,00	50.300,00
Surcharges base			
polished	1	0,00	0,00
powder-coated in deep black	4	0,00	0,00
chromed	0	2.032,00	2.540,00

EA 219	Article no.	without VAT in SEK*	with VAT in SEK*
high backrest, swivel	412 382 00		
with armrests			
Leather L20		42.080,00	52.600,00
Leather L50		49.600,00	62.000,00
Surcharges base			
polished	1	0,00	0,00
powder-coated in deep black	4	0,00	0,00
chromed	0	2.920,00	3.650,00

Leather L20

Leather L50

Castors

Leather/back panel Plano Leather Premium F (contrast seam)/back panel Plano 02 castors hard, braked for carpet
03 castors soft, braked for hard floor

Aluminium Chair EA 124/125

Charles & Ray Eames, 1958

vitra.



EA 124



EA 125

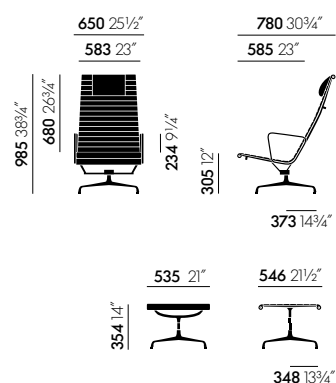

All measurements are pursuant to EN 1335-1:2000
More detailed information is found in the chapter 'Explanation of measurements'.

EA 124

Backrest and seat: chair with high backrest. High-frequency welded upholstery with horizontal ribbing; cover in fabric or leather. Side profiles and spreaders in die-cast aluminium, with a polished or chrome-plated finish or powder-coated in deep black.

Seat mechanism: adjustable backward tilt.

Armrests: die-cast aluminium, with a polished or chrome-plated finish or powder-coated in deep black.

Base: four-star base in die-cast aluminium, with a polished or chrome-plated finish or powder-coated in deep black.

EA 125

Seat: non-swivel. Upholstered with high-frequency welded ribbing in fabric or leather. Side profiles and spreaders in die-cast aluminium, with a polished or chrome-plated finish or powder-coated in deep black.

Base: four-star base in die-cast aluminium, with a polished or chrome-plated finish or powder-coated in deep black.

EA 124

	Article no.	without VAT in SEK*	with VAT in SEK*
swivel		412 366 00	
with armrests			
Fabric F60		32.800,00	41.000,00
Leather L20		40.240,00	50.300,00
Leather L50		46.400,00	58.000,00
Surcharges base			
polished	1	0,00	0,00
powder-coated in deep black	4	0,00	0,00
chromed	0	2.920,00	3.650,00

EA 125

	Article no.	without VAT in SEK*	with VAT in SEK*
stool		412 367 00	
non-swivel			
Fabric F60		13.520,00	16.900,00
Leather L20		16.400,00	20.500,00
Leather L50		18.080,00	22.600,00
Surcharges base			
polished	1	0,00	0,00
powder-coated in deep black	4	0,00	0,00
chromed	0	864,00	1.080,00

Fabric F60

. Hopsak

Leather L20

. Leather/back panel Plano

Leather L50

. Leather Premium F/back panel Plano

Glides

04 glides for carpet
05 felt glides for hard floor

Soft Pad Chair EA 222/223

Charles & Ray Eames, 1969



EA 222



EA 223

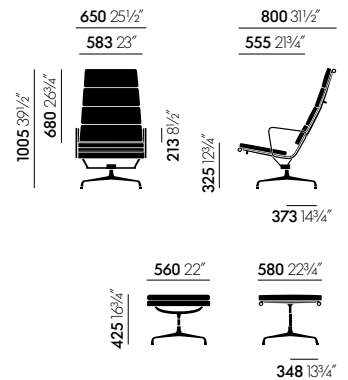

All measurements are pursuant to EN 1335-1:2000
More detailed information is found in the chapter 'Explanation of measurements'.

EA 222

Backrest and seat: chair with high backrest. Five sewn-on cushions with polyurethane foam upholstery in leather. Side profiles and spreaders in die-cast aluminium, with a polished or chrome-plated finish or powder-coated in deep black.

Seat mechanism: adjustable backward tilt.

Armrests: die-cast aluminium, with a polished or chrome-plated finish or powder-coated in deep black.

Base: four-star base in die-cast aluminium, with a polished or chrome-plated finish or powder-coated in deep black.

EA 223

Seat: non-swivel. Sewn-on cushion with polyurethane foam upholstery in leather. Side profiles and spreaders in die-cast aluminium, with a polished or chrome-plated finish or powder-coated in deep black.

Base: four-star base in die-cast aluminium, with a polished or chrome-plated finish or powder-coated in deep black.

EA 222

	Article no.	without VAT in SEK*	with VAT in SEK*
swivel		412 383 00	
with armrests			
Leather L20		42.960,00	53.700,00
Leather L50		49.280,00	61.600,00
Surcharges base			
polished	1	0,00	0,00
powder-coated in deep black	4	0,00	0,00
chromed	0	2.920,00	3.650,00

EA 223

	Article no.	without VAT in SEK*	with VAT in SEK*
Stool		412 384 00	
non-swivel			
Leather L20		17.600,00	22.000,00
Leather L50		20.320,00	25.400,00
Surcharges base			
polished	1	0,00	0,00
powder-coated in deep black	4	0,00	0,00
chromed	0	864,00	1.080,00

Leather L20

Leather L50

Glides

Leather/back panel Plano Leather Premium F (contrast seam)/back panel Plano 04 glides for carpet
05 felt glides for hard floor

APC

Jasper Morrison, 2016

vitra.

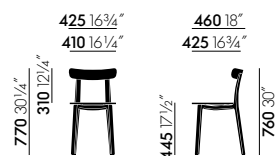

All measurements are pursuant to EN 1335-1:2000
More detailed information is found in the chapter 'Explanation of measurements'.

Backrest, seat and base: dyed-through polypropylene.

Glides: fitted with carpet glides or felt glides for hard floors.

Applications: suitable for outdoor use.

APC

Polypropylene, suitable for outdoor use

Article no.	without VAT in SEK*	with VAT in SEK*
440 388 00	3.032,00	3.790,00

Polypropylene

- 01 white - two-tone
- 02 ice grey - two-tone
- 03 graphite grey - two-tone
- 04 ivy two-tone
- 05 brick - two-tone
- 07 buttercup - two-tone

Glides

- 04 glides for carpet
- 05 felt glides for hard floor

Belleville Chair

Ronan & Erwan Bouroullec, 2015

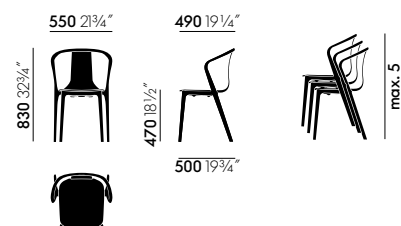

Belleville Armchair

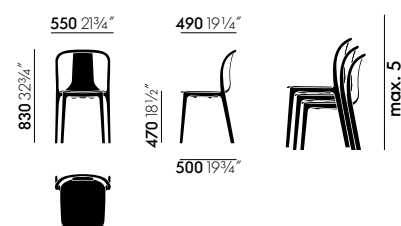

Belleville Chair

All measurements are pursuant to EN 1335-1:2000
More detailed information is found in the chapter 'Explanation of measurements'.

Belleville Chair

Seat shell, base and frame: injection-moulded polyamide. Stackable up to 5 high.

Belleville Chair Wood

Seat shell: moulded plywood, protective natural lacquer finish.

Base and frame: injection-moulded polyamide. Stackable up to 5 high.

Belleville Chair

Ronan & Erwan Bouroullec, 2015

vitra.

Belleville Chair Plastic	Article no.	without VAT in SEK*	with VAT in SEK*
polyamide seat shell, stacking, suitable for outdoor use	440 298 00		
Base deep black	12	3.352,00	4.190,00

Belleville Chair Wood	Article no.	without VAT in SEK*	with VAT in SEK*
wooden seat shell, stacking	440 292 00		
Base deep black	12	4.760,00	5.950,00

Belleville Armchair Plastic	Article no.	without VAT in SEK*	with VAT in SEK*
polyamide seat shell, stacking, suitable for outdoor use	440 299 00		
Base deep black	12	3.880,00	4.850,00

Belleville Armchair Wood	Article no.	without VAT in SEK*	with VAT in SEK*
wooden seat shell, stacking	440 293 00		
Base deep black	12	5.192,00	6.490,00

Seat shell Plastic

12 deep black
30 cream
35 basalt
83 sea blue
94 moss grey

Seat shell Wood

04 dark oak, with protective varnish
10 natural oak, with protective varnish
68 black ash

Glides

04 glides for carpet
05 felt glides for hard floor

Chaise Tout Bois

Jean Prouvé, 1941

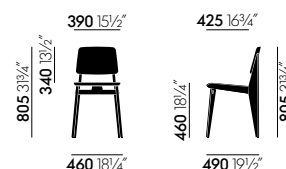

All measurements are pursuant to EN 1335-1:2000
More detailed information is found in the chapter 'Explanation of measurements'.

Seat and backrest: moulded plywood veneer in natural or dark-stained oak, protective natural lacquer finish.

Base: non-stackable solid wood base; same type of wood as backrest and seat in natural or dark-stained oak, protective natural lacquer finish.

Origin of wood: solid oak (*Quercus robur*) from Croatia, veneer wood from the USA.

Chaise Tout Bois	Article no.	without VAT in SEK*	with VAT in SEK*
	210 645 00		
Oak, with protective varnish		7.920,00	9.900,00

Back and seat, veneer (Chaise Tout Bois)

04 dark oak, with protective varnish
10 natural oak, with protective varnish

Wooden base, solid wood (Chaise Tout Bois)

04 dark stained solid oak, with protective varnish
10 natural oak, with protective varnish

Glides

04 glides for carpet
05 felt glides for hard floor

Eames Fiberglass Chairs

Charles & Ray Eames, 1950

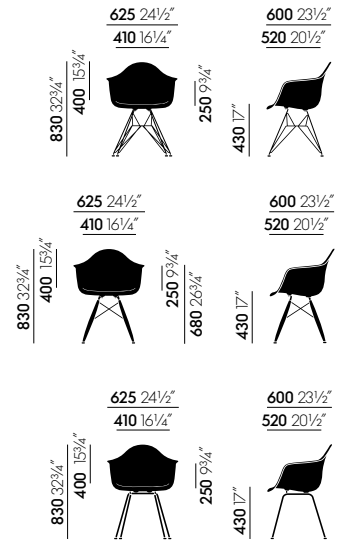

All measurements are pursuant to EN 1335-1:2000
 More detailed information is found in the chapter 'Explanation of measurements'.

Seat shell: dyed-through, glass-fibre reinforced polyester (fibreglass). Just like the earliest models, today's fibreglass shells are also slightly transparent in some colours. Optionally available with a moulded foam seat cushion (screwed to the seat shell); cushion can be replaced by the Vitra service team.

DAR

	Article no.	without VAT in SEK*	with VAT in SEK*
wire base with cross struts	440 440 00		
without upholstery			
		7.616,00	9.520,00
wire base with cross struts	440 441 00		
with seat upholstery			
Fabric F60		8.568,00	10.710,00
Fabric F200		9.816,00	12.270,00

Eames Fiberglass Chairs

Charles & Ray Eames, 1950



DAW	Article no.	without VAT in SEK*	with VAT in SEK*
wood base with cross struts		440 445 00	
without upholstery			
maple	04	9.088,00	11.360,00
ash	05	9.424,00	11.780,00
wood and wire base with cross struts		440 446 00	
with seat upholstery			
maple, fabric F60	04	10.040,00	12.550,00
ash, fabric F60	05	10.376,00	12.970,00
maple, fabric F200	04	11.288,00	14.110,00
ash, fabric F200	05	11.624,00	14.530,00

DAX	Article no.	without VAT in SEK*	with VAT in SEK*
four-legged tubular steel base		440 450 00	
without upholstery			
		7.264,00	9.080,00
four-legged tubular steel base		440 451 00	
with seat upholstery			
Fabric F60		8.216,00	10.270,00
Fabric F200		9.464,00	11.830,00

Fabric F60	Fabric F200	Seat shell (Eames Fiberglass Armchair)	
02 Hopsak	01 Checker	01 Eames Parchment	
		04 Eames Elephant Hide Grey	
		05 Eames Sea Foam Green	
		06 Eames Raw Umber	

Base DAW	Base DAR	Base DAX	Glides
02 golden maple	01 chrome	01 chrome	04 basic dark for carpet
30 black maple	04 white powder-coated (smooth)	04 white powder-coated (smooth)	05 felt basic dark for hard floor
65 honey-toned ash	30 basic dark powder-coated (smooth)	30 basic dark powder-coated (smooth)	14 white for carpet
95 dark maple			15 felt white for hard floor

Eames Fiberglass Chairs

Charles & Ray Eames, 1950

vitra.

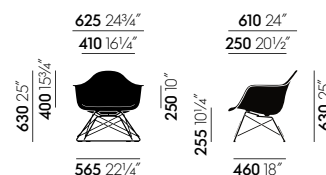

All measurements are pursuant to EN 1335-1:2000
More detailed information is found in the chapter 'Explanation of measurements'.

Seat shell: dyed-through, glass-fibre reinforced polyester (fibreglass). Just like the earliest models, today's fibreglass shells are also slightly transparent in some colours. Optionally available with a moulded foam seat cushion (screwed to the seat shell); cushion can be replaced by the Vitra service team.

LAR	Article no.	without VAT in SEK*	with VAT in SEK*
wire base with cross struts	440 460 00		
without upholstery		8.592,00	10.740,00
wire base with cross struts	440 461 00		
with seat upholstery			
Fabric F60		9.544,00	11.930,00
Fabric F200		10.792,00	13.490,00

Fabric F60	Fabric F200	Seat shell (Eames Fiberglass Armchair)	Base LAR	Glides
. Hopsak	. Checker	01 Eames Parchment 04 Eames Elephant Hide Grey 05 Eames Sea Foam Green 06 Eames Raw Umber	01 chrome 04 white powder-coated (smooth) 30 basic dark powder-coated (smooth)	04 basic dark for carpet 05 felt basic dark for hard floor

Eames Fiberglass Chairs

Charles & Ray Eames, 1950

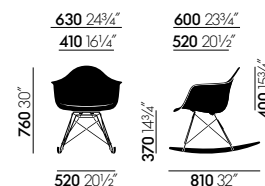

All measurements are pursuant to EN 1335-1:2000
More detailed information is found in the chapter 'Explanation of measurements'.

Seat shell: dyed-through, glass-fibre reinforced polyester (fibreglass). Just like the earliest models, today's fibreglass shells are also slightly transparent in some colours. Optionally available with a moulded foam seat cushion (screwed to the seat shell); cushion can be replaced by the Vitra service team.

RAR	Article no.	without VAT in SEK*	with VAT in SEK*
rocking chair	440 455 00		
without upholstery		9.480,00	11.850,00
rocking chair	440 456 00		
with seat upholstery			
Fabric F60		10.432,00	13.040,00
Fabric F200		11.680,00	14.600,00

Fabric F60	Fabric F200	Seat shell (Eames Fiberglass Armchair)	Base RAR	Rocking skids RAR
Hopsak	Checker	01 Eames Parchment 04 Eames Elephant Hide Grey 05 Eames Sea Foam Green 06 Eames Raw Umber	01 chrome 04 white powder-coated (smooth) 30 basic dark powder-coated (smooth)	02 golden maple 95 dark maple

Eames Fiberglass Chairs

Charles & Ray Eames, 1950

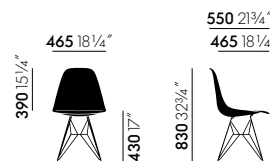

All measurements are pursuant to EN 1335-1:2000
More detailed information is found in the chapter 'Explanation of measurements'.

Seat shell: dyed-through, glass-fibre reinforced polyester (fibreglass). Just like the earliest models, today's fibreglass shells are also slightly transparent in some colours. Optionally available with a moulded foam seat cushion (screwed to the seat shell); cushion can be replaced by the Vitra service team.

Base: non-stacking four-legged wire base with cross struts. (DSR = Dining Height Side Chair Rod Base)

DSR	Article no.	without VAT in SEK*	with VAT in SEK*
wire base with cross struts, non-stacking	440 400 00		
without upholstery		5.928,00	7.410,00
wire base with cross struts, non-stacking	440 401 00		
with seat upholstery			
Fabric F60		6.952,00	8.690,00
Fabric F200		8.136,00	10.170,00

Seat shell (Eames Fiberglass Side Chair)	Fabric F60	Fabric F200	Base DSR	Glides
01 Eames Parchment	Hopsak	Checker	01 chrome	04 basic dark for carpet
02 Eames Navy Blue			04 white powder-coated (smooth)	05 felt basic dark for hard floor
03 Eames Red Orange			30 basic dark powder-coated (smooth)	14 white for carpet
04 Eames Elephant Hide Grey				15 felt white for hard floor
05 Eames Sea Foam Green				
06 Eames Raw Umber				
07 Eames Ochre Light				
08 Eames Ochre Dark				
09 Eames Classic Red				

Eames Fiberglass Chairs

Charles & Ray Eames, 1950

 Quickship

Eames Fiberglass Side Chair DSR, seat shell in colour Eames Elephant Hide Grey		Article no.	without VAT in SEK*	with VAT in SEK*
Base powder-coated in basic dark (smooth)	Felt glides for hard floors in basic dark	QS4 040 0A	5.928,00	7.410,00
Base powder-coated in basic dark (smooth)	Carpet glides in basic dark	QS4 040 0C	5.928,00	7.410,00

 Quickship

Eames Fiberglass Side Chair DSR, shell colour Eames Sea Foam Green		Article no.	without VAT in SEK*	with VAT in SEK*
Base powder-coated in basic dark (smooth)	Felt glides for hard floors in basic dark	QS4 040 0B	5.928,00	7.410,00
Base powder-coated in basic dark (smooth)	Carpet glides in basic dark	QS4 040 0D	5.928,00	7.410,00

Eames Fiberglass Chairs

Charles & Ray Eames, 1950



All measurements are pursuant to EN 1335-1:2000
More detailed information is found in the chapter 'Explanation of measurements'.

Seat shell: dyed-through, glass-fibre reinforced polyester (fibreglass). Just like the earliest models, today's fibreglass shells are also slightly transparent in some colours. Optionally available with a moulded foam seat cushion (screwed to the seat shell); cushion can be replaced by the Vitra service team.

Base: non-stackable wooden base in various shades of maple or honey-toned ash, stained and lacquered finish. Steel rod cross struts in basic dark. (DSW = Dining Height Side Chair Wood Base)

Origin of wood: ash (*Fraxinus excelsior*) and maple (*Acer platanoides*) from Western Europe and/or Poland.

DSW	Article no.	without VAT in SEK*	with VAT in SEK*
wood and wire base with cross struts, non-stacking	440 405 00		
without upholstery			
Base maple		7.400,00	9.250,00
Base ash		7.736,00	9.670,00
wood and wire base with cross struts, non-stacking	440 406 00		
with seat upholstery			
maple, fabric F60		8.424,00	10.530,00
ash, fabric F60		8.760,00	10.950,00
maple, fabric F200		9.608,00	12.010,00
ash, fabric F200		9.944,00	12.430,00

Seat shell (Eames Fiberglass Side Chair)	Fabric F60	Fabric F200	Base DSW	Glides
01 Eames Parchment	Hopsak	Checker	02 golden maple	04 basic dark for carpet
02 Eames Navy Blue			30 black maple	05 felt basic dark for hard floor
03 Eames Red Orange			65 honey-toned ash	14 white for carpet
04 Eames Elephant Hide Grey			95 dark maple	15 felt white for hard floor
05 Eames Sea Foam Green				
06 Eames Raw Umber				
07 Eames Ochre Light				
08 Eames Ochre Dark				
09 Eames Classic Red				

Eames Fiberglass Chairs

Charles & Ray Eames, 1950



Eames Fiberglass Side Chair DSW, shell colour Eames Elephant Hide Grey

		Article no.	without VAT in SEK*	with VAT in SEK*
Base in black maple	Felt glides for hard floors in basic dark	QS4 040 5A	7.400,00	9.250,00
Base in black maple	Carpet glides in basic dark	QS4 040 5E	7.400,00	9.250,00
Base in dark maple	Felt glides for hard floors in basic dark	QS4 040 5B	7.400,00	9.250,00
Base in dark maple	Carpet glides in basic dark	QS4 040 5F	7.400,00	9.250,00



Eames Fiberglass Side Chair DSW, shell colour Eames Sea Foam Green

		Article no.	without VAT in SEK*	with VAT in SEK*
Base in black maple	Felt glides for hard floors in basic dark	QS4 040 5C	7.400,00	9.250,00
Base in black maple	Carpet glides in basic dark	QS4 040 5G	7.400,00	9.250,00
Base in dark maple	Felt glides for hard floors in basic dark	QS4 040 5D	7.400,00	9.250,00
Base in dark maple	Carpet glides in basic dark	QS4 040 5H	7.400,00	9.250,00

Eames Fiberglass Chairs

Charles & Ray Eames, 1950

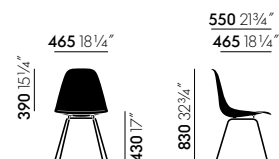

All measurements are pursuant to EN 1335-1:2000
More detailed information is found in the chapter 'Explanation of measurements'.

Seat shell: dyed-through, glass-fibre reinforced polyester (fibreglass). Just like the earliest models, today's fibreglass shells are also slightly transparent in some colours. Optionally available with a moulded foam seat cushion (screwed to the seat shell); cushion can be replaced by the Vitra service team.

Base: non-stacking four-legged tubular steel base. (DSX = Dining Height Side Chair X-Base)

DSX	Article no.	without VAT in SEK*	with VAT in SEK*
four-legged tubular steel base, non-stacking	440 410 00		
without upholstery		5.576,00	6.970,00
four-legged tubular steel base, non-stacking	440 411 00		
with seat upholstery			
Fabric F60		6.600,00	8.250,00
Fabric F200		7.784,00	9.730,00

Seat shell (Eames Fiberglass Side Chair)	Fabric F60	Fabric F200	Base DSX	Glides
01 Eames Parchment	Hopsak	Checker	01 chrome	04 basic dark for carpet
02 Eames Navy Blue			04 white powder-coated (smooth)	05 felt basic dark for hard floor
03 Eames Red Orange			30 basic dark powder-coated (smooth)	14 white for carpet
04 Eames Elephant Hide Grey				15 felt white for hard floor
05 Eames Sea Foam Green				
06 Eames Raw Umber				
07 Eames Ochre Light				
08 Eames Ochre Dark				
09 Eames Classic Red				

Eames Fiberglass Chairs

Charles & Ray Eames, 1950

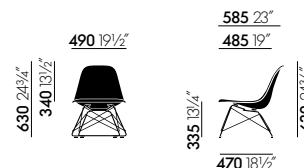

All measurements are pursuant to EN 1335-1:2000
More detailed information is found in the chapter 'Explanation of measurements'.

Seat shell: dyed-through, glass-fibre reinforced polyester (fibreglass). Just like the earliest models, today's fibreglass shells are also slightly transparent in some colours. Optionally available with a moulded foam seat cushion (screwed to the seat shell); cushion can be replaced by the Vitra service team.

Base: wire base with cross struts, chrome-plated or powder-coated finish. Seat height 260 mm. (LSR = Lounge Height Side Chair, Rod Base)

LSR	Article no.	without VAT in SEK*	with VAT in SEK*
wire base with cross struts, non-stacking	440 495 00		
without upholstery		6.904,00	8.630,00
wire base with cross struts, non-stacking	440 496 00		
with seat upholstery			
Fabric F60		7.928,00	9.910,00
Fabric F200		9.112,00	11.390,00

Seat shell (Eames Fiberglass Side Chair)	Fabric F60	Fabric F200	Base LSR	Glides
01 Eames Parchment	Hopsak	Checker	01 chrome	04 basic dark for carpet
02 Eames Navy Blue			04 white powder-coated (smooth)	05 felt basic dark for hard floor
03 Eames Red Orange			30 basic dark powder-coated (smooth)	
04 Eames Elephant Hide Grey				
05 Eames Sea Foam Green				
06 Eames Raw Umber				
07 Eames Ochre Light				
08 Eames Ochre Dark				
09 Eames Classic Red				

Eames Plastic Chairs

Charles & Ray Eames, 1950

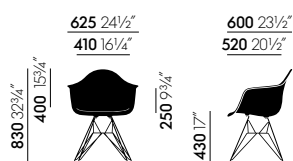

DAR, new height

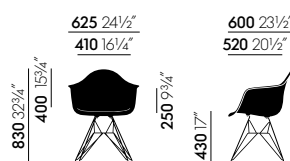

DAR, new height

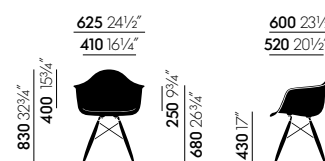

DAW, new height

All measurements are pursuant to EN 1335-1:2000
More detailed information is found in the chapter 'Explanation of measurements'.

Seat shell: dyed-through polypropylene. All models are available with a seat cushion (screwed to the seat shell) or full upholstery. The fully upholstered version has moulded polyurethane foam padding covered in fabric, attached to the shell with a welted edge. Different shell and upholstery colours and various bases provide a multitude of possible combinations.

Options: the Eames Plastic Chair is available as a visitor chair, dining chair, rocking chair, swivel chair or in stacking versions and with ganging brackets for row seating. Beam-mounted shells are suited for use in waiting areas.

Eames Plastic Armchair DAR

Base: wire base with cross struts, chrome-plated or powder-coated finish. The powder-coated version is suitable for outdoor use. (DAR = Dining Height Armchair Rod Base)

Note: special additives retard the fading of colours due to UV radiation. However, if the chair is exposed to sunlight for prolonged periods, the colour may change over time. We recommend limited exposure to sunlight.

Eames Plastic Armchair DAW

Base: wooden base in various shades of maple or honey-toned ash, stained and lacquered finish. Steel rod cross struts in basic dark. (DAW = Dining Height Armchair Wood Base)

Origin of wood: ash (*Fraxinus excelsior*) and maple (*Acer platanoides*) from Western Europe and/or Poland.

Eames Plastic Chairs

Charles & Ray Eames, 1950

vitra.

DAR (new height)	Article no.	without VAT in SEK*	with VAT in SEK*
wire base with cross struts	440 320 00		
without upholstery		4.088,00	5.110,00
wire base with cross struts	440 321 00		
with seat upholstery			
Fabric F60		5.040,00	6.300,00
Fabric F200		6.288,00	7.860,00
wire base with cross struts	440 322 00		
with full upholstery			
Fabric F60		6.904,00	8.630,00
DAW (new height)	Article no.	without VAT in SEK*	with VAT in SEK*
wood and wire base with cross struts	440 325 00		
without upholstery			
maple		5.560,00	6.950,00
ash		5.896,00	7.370,00
wood and wire base with cross struts	440 326 00		
with seat upholstery			
Maple, fabric F60		6.512,00	8.140,00
Ash, fabric F60		6.848,00	8.560,00
Maple, fabric F200		7.760,00	9.700,00
Ash, fabric F200		8.096,00	10.120,00
wood and wire base with cross struts	440 327 00		
with full upholstery			
Maple, fabric F60		8.376,00	10.470,00
Ash, fabric F60		8.712,00	10.890,00

Fabric F60	Fabric F200	Seat shell	Base DAW	Base DAR	Edge	Glides
Hopsak	Checker	03 poppy red 04 white 11 pebble 12 deep black 23 ice grey 24 light grey 26 sunlight	34 mustard 41 pale rose 42 green 43 rusty orange 48 forest 56 granite grey 83 sea blue	02 golden maple 30 black maple 65 honey-toned ash 95 dark maple	01 chrome 04 white powder-coated (smooth) 30 basic dark powder-coated (smooth)	01 basic dark 04 white 05 felt basic dark for hard floor 14 white for carpet 15 felt white for hard floor

Eames Plastic Chairs

Charles & Ray Eames, 1950

vitra.

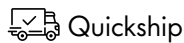

Eames Plastic Armchair DAR, shell colour white

		Article no.	without VAT in SEK*	with VAT in SEK*
chrome-plated base	Felt glides for hard floors in basic dark	QS4 032 0A	4.088,00	5.110,00
Chrome-plated base	Carpet glides in basic dark	QS4 032 0C	4.088,00	5.110,00

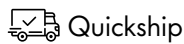

Eames Plastic Armchair DAR, shell colour deep black

		Article no.	without VAT in SEK*	with VAT in SEK*
chrome-plated base	Felt glides for hard floors in basic dark	QS4 032 0B	4.088,00	5.110,00
chrome-plated base	Carpet glides in basic dark	QS4 032 0D	4.088,00	5.110,00

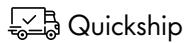

Eames Plastic Armchair DAW, shell colour white

		Article no.	without VAT in SEK*	with VAT in SEK*
Base in honey-toned ash	Felt glides for hard floors in basic dark	QS4 032 5A	5.896,00	7.370,00
Base in honey-toned ash	Carpet glides in basic dark	QS4 032 5F	5.896,00	7.370,00
Base in golden maple	Felt glides for hard floors in basic dark	QS4 032 5B	5.560,00	6.950,00
Base in golden maple	Carpet glides in basic dark	QS4 032 5E	5.560,00	6.950,00



Eames Plastic Armchair DAW, shell colour deep black

		Article no.	without VAT in SEK*	with VAT in SEK*
Base in honey-toned ash	Felt glides for hard floors in basic dark	QS4 032 5C	5.896,00	7.370,00
Base in honey-toned ash	Carpet glides in basic dark	QS4 032 5H	5.896,00	7.370,00
Base in golden maple	Felt glides for hard floors in basic dark	QS4 032 5D	5.560,00	6.950,00
Base in golden maple	Carpet glides in basic dark	QS4 032 5G	5.560,00	6.950,00

Fabric F60	Fabric F200	Seat shell		Base DAW		Base DAR		Edge	Glides
Hopsak	Checker	03 poppy red	34 mustard	02 golden maple	01 chrome	01 basic dark	04 basic dark for carpet	04 white	05 felt basic dark for hard floor
		04 white	41 pale rose	30 black maple	04 white powder-coated (smooth)		14 white for carpet		15 felt white for hard floor
		11 pebble	42 green	65 honey-toned ash	30 basic dark powder-coated (smooth)				
		12 deep black	43 rusty orange	95 dark maple					
		23 ice grey	48 forest						
		24 light grey	56 granite grey						
		26 sunlight	83 sea blue						

Eames Plastic Chairs

Charles & Ray Eames, 1950

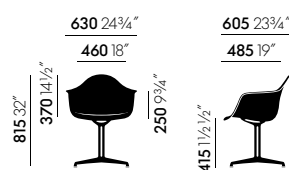

DAL

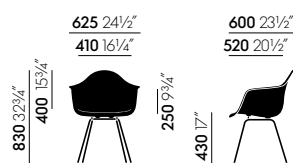

DAX, new height

All measurements are pursuant to EN 1335-1:2000
More detailed information is found in the chapter 'Explanation of measurements'.

Seat shell: dyed-through polypropylene. All models are available with a seat cushion (screwed to the seat shell) or full upholstery. The fully upholstered version has moulded polyurethane foam padding covered in fabric, attached to the shell with a welted edge. Different shell and upholstery colours and various bases provide a multitude of possible combinations.

Options: the Eames Plastic Chair is available as a visitor chair, dining chair, rocking chair, swivel chair or in stacking versions and with ganging brackets for row seating. Beam-mounted shells are suited for use in waiting areas.

Eames Plastic Armchair DAL

Base: La Fonda base in polished die-cast aluminium. (DAL = Dining Height Armchair La Fonda Base)

Eames Plastic Armchair DAX

Base: four-legged tubular steel base, chrome-plated or powder-coated. The powder-coated version is suitable for outdoor use. (DAX = Dining Height Armchair X-Base)

Note: special additives retard the fading of colours due to UV radiation. However, if the chair is exposed to sunlight for prolonged periods, the colour may change over time. We recommend limited exposure to sunlight.

Eames Plastic Chairs

Charles & Ray Eames, 1950

vitra.

DAL	Article no.	without VAT in SEK*	with VAT in SEK*
polished die-cast aluminium base	440 360 00		
without upholstery		7.256,00	9.070,00
polished die-cast aluminium base	440 361 00		
with seat upholstery			
Fabric F60		8.208,00	10.260,00
Fabric F200		9.456,00	11.820,00
polished die-cast aluminium base	440 362 00		
with full upholstery			
Fabric F60		10.072,00	12.590,00
DAX (new height)	Article no.	without VAT in SEK*	with VAT in SEK*
four-legged tubular steel base	440 330 00		
without upholstery		3.736,00	4.670,00
four-legged tubular steel base	440 331 00		
with seat upholstery			
Fabric F60		4.688,00	5.860,00
Fabric F200		5.936,00	7.420,00
four-legged tubular steel base	440 332 00		
with full upholstery			
Fabric F60		6.552,00	8.190,00

Fabric F60	Fabric F200	Seat shell	Base DAL	Base DAX	Edge	Glides
Hopsak	Checker	03 poppy red 04 white 11 pebble 12 deep black 23 ice grey 24 light grey 26 sunlight	34 mustard 41 pale rose 42 green 43 rusty orange 48 forest 56 granite grey 83 sea blue	03 polished aluminium 01 chrome 04 white powder-coated (smooth) 30 basic dark powder-coated (smooth)	01 basic dark 04 white	04 basic dark for carpet 05 felt basic dark for hard floor 14 white for carpet 15 felt white for hard floor

Eames Plastic Chairs

Charles & Ray Eames, 1950

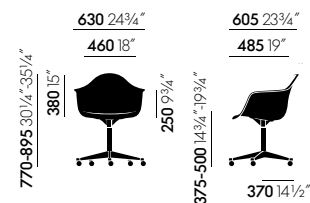

All measurements are pursuant to EN 1335-1:2000
More detailed information is found in the chapter 'Explanation of measurements'.

Seat shell: dyed-through polypropylene. All models are available with a seat cushion (screwed to the seat shell) or full upholstery. The fully upholstered version has moulded polyurethane foam padding covered in fabric, attached to the shell with a welted edge. Different shell and upholstery colours and various bases provide a multitude of possible combinations.

Options: the Eames Plastic Chair is available as a visitor chair, dining chair, rocking chair, swivel chair or in stacking versions and with ganging brackets for row seating. Beam-mounted shells are suited for use in waiting areas.

Eames Plastic Armchair PACC

Base: five-star base in polished die-cast aluminium with double castors in basic dark. (PACC = Pivot Armchair Cast Base on Castors)

PACC	Article no.	without VAT in SEK*	with VAT in SEK*
castor-based swivel chair, height-adjustable	440 355 00		
without upholstery		6.984,00	8.730,00
castor-based swivel chair, height-adjustable	440 356 00		
with seat upholstery			
Fabric F60		7.936,00	9.920,00
Fabric F200		9.184,00	11.480,00
castor-based swivel chair, height-adjustable	440 357 00		
with full upholstery			
Fabric F60		9.800,00	12.250,00

Fabric F60	Fabric F200	Seat shell	Edge	Castors
Hopsak	Checker	03 poppy red 04 white 11 pebble 12 deep black 23 ice grey 24 light grey 26 sunlight	34 mustard 41 pale rose 42 green 43 rusty orange 48 forest 56 granite grey 83 sea blue	01 basic dark 04 white 02 castors hard, braked for carpet 03 castors soft, braked for hard floor

Eames Plastic Chairs

Charles & Ray Eames, 1950

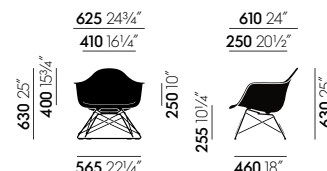

All measurements are pursuant to EN 1335-1:2000
More detailed information is found in the chapter 'Explanation of measurements'.

Seat shell: dyed-through polypropylene. All models are available with a seat cushion (screwed to the seat shell) or full upholstery. The fully upholstered version has moulded polyurethane foam padding covered in fabric, attached to the shell with a welted edge. Different shell and upholstery colours and various bases provide a multitude of possible combinations.

Options: the Eames Plastic Chair is available as a visitor chair, dining chair, rocking chair, swivel chair or in stacking versions and with ganging brackets for row seating. Beam-mounted shells are suited for use in waiting areas.

LAR base: wire base with cross struts, chrome-plated or powder-coated finish. Seat height 256 mm. (LAR = Lounge Height Armchair, Rod Base)

LAR	Article no.	without VAT in SEK*	with VAT in SEK*
wire base with cross struts	440 475 00		
without upholstery		5.064,00	6.330,00
wire base with cross struts	440 476 00		
with seat upholstery			
Fabric F60		6.016,00	7.520,00
Fabric F200		7.264,00	9.080,00
wire base with cross struts	440 477 00		
with full upholstery			
Fabric F60		7.880,00	9.850,00

Fabric F60	Fabric F200	Seat shell	Base LAR	Edge	Glides
Hopsak	Checker	03 poppy red 04 white 11 pebble 12 deep black 23 ice grey 24 light grey 26 sunlight	34 mustard 41 pale rose 42 green 43 rusty orange 48 forest 56 granite grey 83 sea blue	01 chrome 04 white powder-coated (smooth) 30 basic dark powder-coated (smooth)	01 basic dark 04 white 04 basic dark for carpet 05 felt basic dark for hard floor

Eames Plastic Armchair RAR

Charles & Ray Eames, 1950

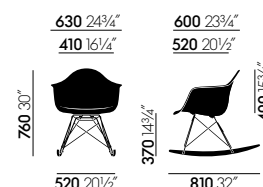

All measurements are pursuant to EN 1335-1:2000
More detailed information is found in the chapter 'Explanation of measurements'.

Seat shell: dyed-through polypropylene. All models are available with a seat cushion (screwed to the seat shell) or full upholstery. The fully upholstered version has moulded polyurethane foam padding covered in fabric, attached to the shell with a welted edge. Different shell and upholstery colours and various bases provide a multitude of possible combinations.

Options: the Eames Plastic Chair is available as a visitor chair, dining chair, rocking chair, swivel chair or in stacking versions and with ganging brackets for row seating. Beam-mounted shells are suited for use in waiting areas.

Eames Plastic Armchair RAR

RAR base: wire base with cross struts, chrome-plated or powder-coated, solid maple runners. (RAR = Rocking Armchair Rod Base)

Origin of wood: maple (*Acer platanoides*) from Western Europe and/or Poland.

RAR	Article no.	without VAT in SEK*	with VAT in SEK*
rocking chair	440 365 00		
without seat upholstery		5.952,00	7.440,00
rocking chair	440 366 00		
with seat upholstery			
Fabric F60		6.904,00	8.630,00
Fabric F200		8.152,00	10.190,00
rocking chair	440 367 00		
with full upholstery			
Fabric F60		8.768,00	10.960,00

Fabric F60	Fabric F200	Seat shell	Base RAR	Edge	Rocking skids RAR
Hopsak	Checker	03 poppy red 04 white 11 pebble 12 deep black 23 ice grey 24 light grey 26 sunlight	34 mustard 41 pale rose 42 green 43 rusty orange 48 forest 56 granite grey 83 sea blue	01 basic dark 04 white	02 golden maple 95 dark maple
			01 chrome 04 white powder-coated (smooth) 30 basic dark powder-coated (smooth)		

Eames Plastic Chairs

Charles & Ray Eames, 1950

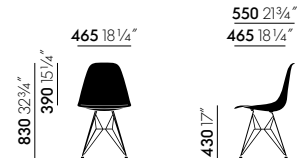

DSR, new height

All measurements are pursuant to EN 1335-1:2000
More detailed information is found in the chapter 'Explanation of measurements'.

Seat shell: dyed-through polypropylene. All models are available with a seat cushion (screwed to the seat shell) or full upholstery. The fully upholstered version has moulded polyurethane foam padding covered in fabric, attached to the shell with a welted edge. Different shell and upholstery colours and various bases provide a multitude of possible combinations.

Options: the Eames Plastic Chair is available as a visitor chair, dining chair, rocking chair, swivel chair or in stacking versions and with ganging brackets for row seating. Beam-mounted shells are suited for use in waiting areas.

Base: non-stacking four-legged wire base with cross struts. The powder-coated version is suitable for outdoor use. (DSR = Dining Height Side Chair Rod Base)

Note: special additives retard the fading of colours due to UV radiation. However, if the chair is exposed to sunlight for prolonged periods, the colour may change over time. We recommend limited exposure to sunlight.

DSR (new height)

	Article no.	without VAT in SEK*	with VAT in SEK*
wire base with cross struts, non-stacking	440 300 00		
without upholstery		2.952,00	3.690,00
wire base with cross struts, non-stacking	440 301 00		
with seat upholstery			
Fabric F60		3.976,00	4.970,00
Fabric F200		5.160,00	6.450,00
wire base with cross struts, non-stacking	440 302 00		
with full upholstery			
Fabric F60		4.984,00	6.230,00
Fabric F200		7.384,00	9.230,00

Fabric F60	Fabric F200	Seat shell	Base DSR	Edge	Glides	
Hopsak	Checker	03 poppy red 04 white 11 pebble 12 deep black 23 ice grey 24 light grey 26 sunlight	34 mustard 41 pale rose 42 green 43 rusty orange 48 forest 56 granite grey 83 sea blue	01 chrome 04 white powder-coated (smooth) 30 basic dark powder-coated (smooth)	01 basic dark 04 white	04 basic dark for carpet 05 felt basic dark for hard floor 14 white for carpet 15 felt white for hard floor

Eames Plastic Chairs

Charles & Ray Eames, 1950



DSR Colours

	Article no.	without VAT in SEK*	with VAT in SEK*
Wire base with cross struts, powder-coated, non-stacking, glides in black			
without upholstery			
Shell in pebble 11, base in Eames Sea Foam Green 31	440 300 01	2.952,00	3.690,00
Shell in mustard 34, base in citron 92	440 300 02	2.952,00	3.690,00
Shell in sea blue 83, base in sky blue 93	440 300 03	2.952,00	3.690,00
Shell in forest 48, base in dark green 24	440 300 04	2.952,00	3.690,00

Quickship

Eames Plastic Side Chair DSR, shell colour white

		Article no.	without VAT in SEK*	with VAT in SEK*
Chrome-plated base	Felt glides for hard floors in basic dark	QS4 030 0A	2.952,00	3.690,00
Chrome-plated base	Carpet glides in basic dark	QS4 030 0C	2.952,00	3.690,00

Quickship

Eames Plastic Side Chair DSR, shell colour deep black

		Article no.	without VAT in SEK*	with VAT in SEK*
Chrome-plated base	Felt glides for hard floors in basic dark	QS4 030 0B	2.952,00	3.690,00
Chrome-plated base	Carpet glides in basic dark	QS4 030 0D	2.952,00	3.690,00

Eames Plastic Chairs

Charles & Ray Eames, 1950

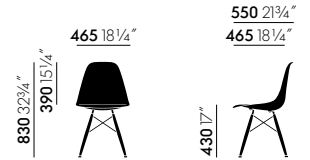

DSW, new height

All measurements are pursuant to EN 1335-1:2000
More detailed information is found in the chapter 'Explanation of measurements'.

Seat shell: dyed-through polypropylene. All models are available with a seat cushion (screwed to the seat shell) or full upholstery. The fully upholstered version has moulded polyurethane foam padding covered in fabric, attached to the shell with a welted edge. Different shell and upholstery colours and various bases provide a multitude of possible combinations.

Options: the Eames Plastic Chair is available as a visitor chair, dining chair, rocking chair, swivel chair or in stacking versions and with ganging brackets for row seating. Beam-mounted shells are suited for use in waiting areas.

Base: non-stackable wooden base in various shades of maple or honey-toned ash, stained and lacquered finish. Steel rod cross struts in basic dark. (DSW = Dining Height Side Chair Wood Base)

Origin of wood: ash (*Fraxinus excelsior*) and maple (*Acer platanoides*) from Western Europe and/or Poland.

DSW (new height)

	Article no.	without VAT in SEK*	with VAT in SEK*
wood and wire base with cross struts, non-stacking	440 305 00		
without upholstery			
maple		4.424,00	5.530,00
ash		4.760,00	5.950,00
wood and wire base with cross struts, non-stacking	440 306 00		
with seat upholstery			
Maple, Fabric F60		5.448,00	6.810,00
Ash, fabric F60		5.784,00	7.230,00
Maple, fabric F200		6.632,00	8.290,00
Ash, fabric F200		6.968,00	8.710,00
wood and wire base with cross struts, non-stacking	440 307 00		
with full upholstery			
Maple, Fabric F60		6.456,00	8.070,00
Ash, fabric F60		6.792,00	8.490,00
Maple, fabric F200		8.856,00	11.070,00
Ash, fabric F200		9.192,00	11.490,00

Fabric F60	Fabric F200	Seat shell	Base DSW	Edge	Glides
Hopsak	Checker	03 poppy red	34 mustard	02 golden maple	04 basic dark for carpet
		04 white	41 pale rose	30 black maple	05 felt basic dark for hard floor
		11 pebble	42 green	65 honey-toned ash	14 white for carpet
		12 deep black	43 rusty orange	95 dark maple	15 felt white for hard floor
		23 ice grey	48 forest		
		24 light grey	56 granite grey		
		26 sunlight	83 sea blue		

Eames Plastic Chairs

Charles & Ray Eames, 1950



Eames Plastic Side Chair DSW, shell colour white

		Article no.	without VAT in SEK*	with VAT in SEK*
Base in honey-toned ash	Felt glides for hard floors in basic dark	QS4 030 5B	4.760,00	5.950,00
Base in honey-toned ash	Carpet glides in basic dark	QS4 030 5F	4.760,00	5.950,00
Base in golden maple	Felt glides for hard floors in basic dark	QS4 030 5A	4.424,00	5.530,00
Base in golden maple	Carpet glides in basic dark	QS4 030 5E	4.424,00	5.530,00



Eames Plastic Side Chair DSW, shell colour deep black

		Article no.	without VAT in SEK*	with VAT in SEK*
Base in honey-toned ash	Felt glides for hard floors in basic dark	QS4 030 5D	4.760,00	5.950,00
Base in honey-toned ash	Carpet glides in basic dark	QS4 030 5H	4.760,00	5.950,00
Base in golden maple	Felt glides for hard floors in basic dark	QS4 030 5C	4.424,00	5.530,00
Base in golden maple	Carpet glides in basic dark	QS4 030 5G	4.424,00	5.530,00

Eames Plastic Chairs

Charles & Ray Eames, 1950

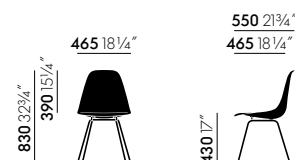

DSX, new height

All measurements are pursuant to EN 1335-1:2000
More detailed information is found in the chapter 'Explanation of measurements'.

Seat shell: dyed-through polypropylene. All models are available with a seat cushion (screwed to the seat shell) or full upholstery. The fully upholstered version has moulded polyurethane foam padding covered in fabric, attached to the shell with a welted edge. Different shell and upholstery colours and various bases provide a multitude of possible combinations.

Options: the Eames Plastic Chair is available as a visitor chair, dining chair, rocking chair, swivel chair or in stacking versions and with ganging brackets for row seating. Beam-mounted shells are suited for use in waiting areas.

Base: non-stacking four-legged tubular steel base. The powder-coated version is suitable for outdoor use. (DSX = Dining Height Side Chair X-Base)

Note: special additives retard the fading of colours due to UV radiation. However, if the chair is exposed to sunlight for prolonged periods, the colour may change over time. We recommend limited exposure to sunlight.

DSX (new height)	Article no.	without VAT in SEK*	with VAT in SEK*
four-legged tubular steel base, non-stacking	440 310 00		
without upholstery		2.600,00	3.250,00
four-legged tubular steel base, non-stacking	440 311 00		
with seat upholstery			
Fabric F60		3.624,00	4.530,00
Fabric F200		4.808,00	6.010,00
four-legged tubular steel base, non-stacking	440 312 00		
with full upholstery			
Fabric F60		4.632,00	5.790,00
Fabric F200		7.032,00	8.790,00

Fabric F60	Fabric F200	Seat shell	Base DSX	Edge	Glides
Hopsak	Checker	03 poppy red 04 white 11 pebble 12 deep black 23 ice grey 24 light grey 26 sunlight	34 mustard 41 pale rose 42 green 43 rusty orange 48 forest 56 granite grey 83 sea blue	01 chrome 04 white powder-coated (smooth) 30 basic dark powder-coated (smooth)	01 basic dark 04 white 04 basic dark for carpet 05 felt basic dark for hard floor 14 white for carpet 15 felt white for hard floor

Eames Plastic Chairs

Charles & Ray Eames, 1950

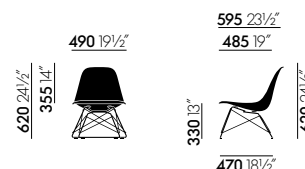

LSR

All measurements are pursuant to EN 1335-1:2000
More detailed information is found in the chapter 'Explanation of measurements'.

Seat shell: dyed-through polypropylene. All models are available with a seat cushion (screwed to the seat shell) or full upholstery. The fully upholstered version has moulded polyurethane foam padding covered in fabric, attached to the shell with a welted edge. Different shell and upholstery colours and various bases provide a multitude of possible combinations.

Options: the Eames Plastic Chair is available as a visitor chair, dining chair, rocking chair, swivel chair or in stacking versions and with ganging brackets for row seating. Beam-mounted shells are suited for use in waiting areas.

Base: wire base with cross struts, chrome-plated or powder-coated finish. The powder-coated version is suitable for outdoor use. Seat height 260 mm. (LSR = Lounge Height Side Chair, Rod Base)

Note: special additives retard the fading of colours due to UV radiation. However, if the chair is exposed to sunlight for prolonged periods, the colour may change over time. We recommend limited exposure to sunlight.

LSR	Article no.	without VAT in SEK*	with VAT in SEK*
wire base with cross struts, non-stacking	440 490 00		
without upholstery		3.928,00	4.910,00
wire base with cross struts, non-stacking	440 491 00		
with seat upholstery			
Fabric F60		4.952,00	6.190,00
Fabric F200		6.136,00	7.670,00
wire base with cross struts, non-stacking	440 492 00		
with full upholstery			
Fabric F60		5.960,00	7.450,00
Fabric F200		8.360,00	10.450,00

Fabric F60	Fabric F200	Seat shell	Base LSR	Glides	
Hopsak	Checker	03 poppy red 04 white 11 pebble 12 deep black 23 ice grey 24 light grey 26 sunlight	34 mustard 41 pale rose 42 green 43 rusty orange 48 forest 56 granite grey 83 sea blue	01 chrome 04 white powder-coated (smooth) 30 basic dark powder-coated (smooth)	04 basic dark for carpet 05 felt basic dark for hard floor

Eames Plastic Chairs

Charles & Ray Eames, 1950



DSS

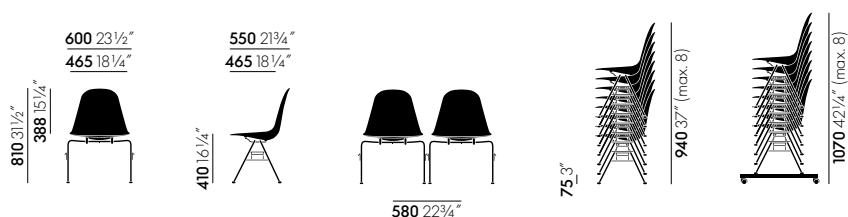

All measurements are pursuant to EN 1335-1:2000
 More detailed information is found in the chapter 'Explanation of measurements'.

Seat shell: dyed-through polypropylene. All models are available with a seat cushion (screwed to the seat shell) or full upholstery. The fully upholstered version has moulded polyurethane foam padding covered in fabric, attached to the shell with a welted edge. Different shell and upholstery colours and various bases provide a multitude of possible combinations.

Options: the Eames Plastic Chair is available as a visitor chair, dining chair, rocking chair, swivel chair or in stacking versions and with ganging brackets for row seating. Beam-mounted shells are suited for use in waiting areas.

Base: chrome-plated tubular steel base, DSS with ganging bracket. (DSS = Dining Height Side Chair Stacking Base)

Stacking: Version without upholstery can be stacked up to 8 chairs on the floor or on a stacking trolley. Version with seat and full upholstery: up to 5 chairs can be stacked on the floor, up to 6 chairs on a stacking trolley.

Eames Plastic Chairs

Charles & Ray Eames, 1950

vitra.

DSS	Article no.	without VAT in SEK*	with VAT in SEK*
stacking and linking	440 345 00		
without upholstery		2.600,00	3.250,00
stacking and linking	440 346 00		
with seat upholstery			
Fabric F60		3.624,00	4.530,00
Fabric F200		4.808,00	6.010,00
stacking and linking	440 347 00		
with full upholstery			
Fabric F60		4.632,00	5.790,00
Fabric F200		7.032,00	8.790,00

Stacking dolly	Article no.	without VAT in SEK*	with VAT in SEK*
for up to 8 upholstered chairs	442 027 00	6.160,00	7.700,00
for 4 chairs with seat cushions or 6 with full upholstery	442 028 00	6.600,00	8.250,00

Number clips	Article no.	without VAT in SEK*	with VAT in SEK*
Set of 10 items	442 044 00		
	01	176,00	220,00

Row numbering element	Article no.	without VAT in SEK*	with VAT in SEK*
Plastic sign to clip to the chair at the end of a row	442 021 00	104,00	130,00

Fabric F60	Fabric F200	Seat shell	Number clips	Edge	Glides
Hopsak	Checker	03 poppy red 04 white 11 pebble 12 deep black 23 ice grey 24 light grey 26 sunlight	34 mustard 41 pale rose 42 green 43 rusty orange 48 forest 56 granite grey 83 sea blue	01 numbers (1 set 1-10) 02 numbers (1 set 11-20) 03 numbers (1 set 21-30) 04 numbers (1 set 31-40) 05 numbers (1 set 41-50)	01 basic dark 04 white 04 basic dark for carpet 05 felt basic dark for hard floor 14 white for carpet 15 felt white for hard floor

Eames Plastic Chairs

Charles & Ray Eames, 1950

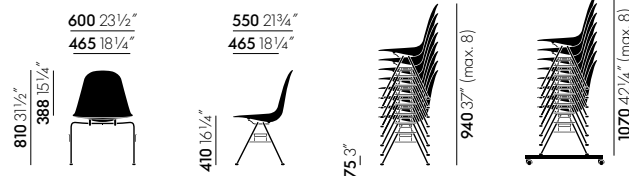

DSS-N

All measurements are pursuant to EN 1335-1:2000
More detailed information is found in the chapter 'Explanation of measurements'.

Seat shell: dyed-through polypropylene. All models are available with a seat cushion (screwed to the seat shell) or full upholstery. The fully upholstered version has moulded polyurethane foam padding covered in fabric, attached to the shell with a welted edge. Different shell and upholstery colours and various bases provide a multitude of possible combinations.

Options: the Eames Plastic Chair is available as a visitor chair, dining chair, rocking chair, swivel chair or in stacking versions and with ganging brackets for row seating. Beam-mounted shells are suited for use in waiting areas.

Base: chrome-plated tubular steel base, DSS-N without ganging brackets. (DSS-N = Dining Height Side Chair Stacking Base Non-Link)

Stacking: Version without upholstery can be stacked up to 8 chairs on the floor or on a stacking trolley. Version with seat and full upholstery: up to 5 chairs can be stacked on the floor, up to 6 chairs on a stacking trolley.

DSS-N	Article no.	without VAT in SEK*	with VAT in SEK*
stacking	440 340 00		
without upholstery		2.600,00	3.250,00
stacking	440 341 00		
with seat upholstery			
Fabric F60		3.624,00	4.530,00
Fabric F200		4.808,00	6.010,00
stacking	440 342 00		
with full upholstery			
Fabric F60		4.632,00	5.790,00
Fabric F200		7.032,00	8.790,00
Stacking dolly	Article no.	without VAT in SEK*	with VAT in SEK*
for up to 8 unupholstered chairs	442 027 00	6.160,00	7.700,00
for 4 chairs with seat cushions or 6 with full upholstery	442 028 00	6.600,00	8.250,00

Fabric F60	Fabric F200	Seat shell	Number clips	Edge	Glides
Hopsak	Checker	03 poppy red	34 mustard	01 basic dark	04 basic dark for carpet
		04 white	41 pale rose	04 white	05 felt basic dark for hard floor
		11 pebble	42 green		14 white for carpet
		12 deep black	43 rusty orange		15 felt white for hard floor
		23 ice grey	48 forest		
		24 light grey	56 granite grey		
		26 sunlight	83 sea blue		

Eames Plastic Chairs

Charles & Ray Eames, 1950

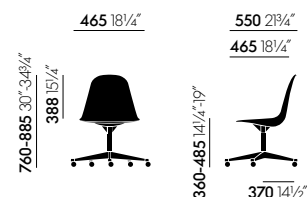

PSCC

All measurements are pursuant to EN 1335-1:2000
More detailed information is found in the chapter 'Explanation of measurements'.

Seat shell: dyed-through polypropylene. All models are available with a seat cushion (screwed to the seat shell) or full upholstery. The fully upholstered version has moulded polyurethane foam padding covered in fabric, attached to the shell with a welted edge. Different shell and upholstery colours and various bases provide a multitude of possible combinations.

Options: the Eames Plastic Chair is available as a visitor chair, dining chair, rocking chair, swivel chair or in stacking versions and with ganging brackets for row seating. Beam-mounted shells are suited for use in waiting areas.

Base: five-star base in polished die-cast aluminium with double castors in basic dark. (PSCC = Pivot Side Chair Cast Base on Castors)

PSCC

	Article no.	without VAT in SEK*	with VAT in SEK*
castor-based swivel chair, height-adjustable	440 335 00		
without upholstery			
		5.848,00	7.310,00
castor-based swivel chair, height-adjustable	440 336 00		
with seat upholstery			
Fabric F60		6.872,00	8.590,00
Fabric F200		8.056,00	10.070,00
castor-based swivel chair, height-adjustable	440 337 00		
with full upholstery			
Fabric F60		7.880,00	9.850,00
Fabric F200		10.280,00	12.850,00

Fabric F60	Fabric F200	Seat shell	Edge	Castors
Hopsak	Checker	03 poppy red 04 white 11 pebble 12 deep black 23 ice grey 24 light grey 26 sunlight	34 mustard 41 pale rose 42 green 43 rusty orange 48 forest 56 granite grey 83 sea blue	01 basic dark 04 white 02 castors hard, braked for carpet 03 castors soft, braked for hard floor

EVO-C

Jasper Morrison, 2020

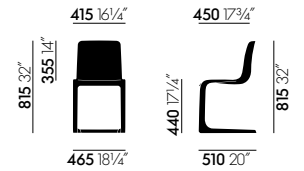

All measurements are pursuant to EN 1335-1:2000
 More detailed information is found in the chapter 'Explanation of measurements'.

Back, seat and base: dyed-through polypropylene, 100% recyclable. Matt finish.

EVO-C

All-plastic chair

Polypropylene, recyclable

Article no. without VAT with VAT
 in SEK* in SEK*

440 478 00

3.592,00 **4.490,00**

Plastic

- 03 poppy red
- 49 ivory
- 54 graphite grey
- 62 light mint

Fauteuil Direction

Jean Prouvé, 1951

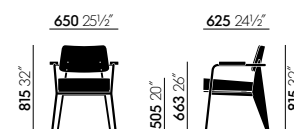

Seat and backrest: polyurethane filling; cover in fabric or leather.

Seat height: 505 mm (445 mm with applied load, measured in accordance with EN 1335-1:2000).

Armrests: solid wood in natural oak with oiled finish, dark stained oak with protective natural lacquer finish, or American walnut with oiled finish.

Base: bent sheet steel and tubular steel, powder-coated (smooth).

Glides: hard glides for carpet or felt glides for hard floors.

Origin of wood: oak (*Quercus robur*) from Western Europe and/or Poland; American walnut (*Juglans nigra*) from the USA.

Note: the steel frame in Métal Brut has a raw irregular surface protected by a transparent powder coating.

Fauteuil Direction

	Article no.	without VAT in SEK*	with VAT in SEK*
	210 439 00		
Fabric F60		20.880,00	26.100,00
Fabric F80		21.360,00	26.700,00
Fabric F100		21.760,00	27.200,00
Leather L50		26.400,00	33.000,00
Surcharges base			
Colour group 1		0,00	0,00
Colour group 2		920,00	1.150,00

Fabric F60	Fabric F80	Fabric F100	Leather L50	Armrests	Glides
Twill	Tress	Nubia	Leather Premium F	04 dark stained solid oak, with protective varnish	04 glides for carpet
Volo				70 natural solid oak, oiled	05 felt glides for hard floor
				75 solid American walnut, oiled	

Base frame Colour group 1

06 Japanese red powder-coated (smooth)
12 deep black powder-coated (smooth)
88 Prouvé Blanc Colombe (Ecrú) powder-coated (smooth)

Base frame Colour group 2

13 Prouvé Gris Vermeer powder-coated (smooth)
14 Prouvé Bleu Dynastie powder-coated (smooth)
18 Prouvé Blé Vert powder-coated (smooth)
41 Prouvé Bleu Marcoule powder-coated (smooth)
94 Prouvé Métal Brut powder-coated (transparent, smooth)

HAL

Jasper Morrison, 2010/2014

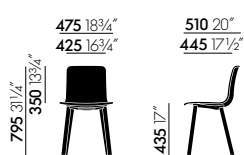

HAL RE Wood

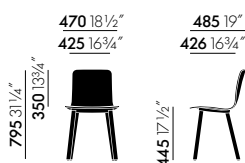

HAL Ply Wood

All measurements are pursuant to EN 1335-1:2000

More detailed information is found in the chapter 'Explanation of measurements'.

HAL RE Wood

Seat shell: recycled, dyed-through polypropylene, with optional seat cushion (screwed to the seat shell).

Base: non-stackable wooden base in natural or dark oak. Connecting element between shell and base in die-cast aluminium, powder-coated in dim grey.

Origin of wood: oak (*Quercus robur*) from Western Europe and/or Poland.

HAL Ply Wood

Seat shell: plywood.

Base: non-stackable wooden base in natural oak or dark oak. Connecting element between shell and base in die-cast aluminium, powder-coated in dim grey.

Origin of wood: oak (*Quercus robur*) from Western Europe and/or Poland.

Glides: colour matched to the small attachment parts for the seat shell, choice of white (except HAL Wood and HAL Ply Wood) or deep black. All bases fitted with glides for carpet; felt glides optionally available for hard floors.

HAL

Jasper Morrison, 2010/2014

HAL RE Wood	Article no.	without VAT in SEK*	with VAT in SEK*
wood base, non-stacking	440 500 00		
Base natural oak, with protective varnish, without seat upholstery	10	4.376,00	5.470,00
Base dark oak, with protective varnish, without seat upholstery	04	4.376,00	5.470,00
wood base, non-stacking	440 501 00		
Base natural oak, with protective varnish, with seat upholstery F60	10	5.464,00	6.830,00
Base dark oak, with protective varnish, with seat upholstery F60	04	5.464,00	6.830,00

HAL Ply Wood	Article no.	without VAT in SEK*	with VAT in SEK*
wooden base, non-stacking	440 222 00		
Seat shell natural oak, with protective varnish	01	6.360,00	7.950,00
Seat shell dark oak, with protective varnish	02	6.360,00	7.950,00

Seat fabric F60	Seat shell HAL RE	Colours (Glides)	Glides
Hopsak	12 deep black RE 14 ivy RE 23 ice grey RE 29 brick RE 31 warm grey RE 35 basalt RE 85 cotton white RE 86 cardboard RE	04 white 12 deep black	04 glides for carpet 05 felt glides for hard floor

HAL

Jasper Morrison, 2010/2014

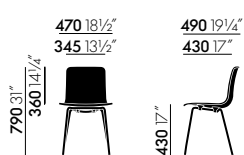

HAL RE Tube

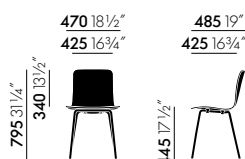

HAL Ply Tube



HAL Ply Tube Stackable

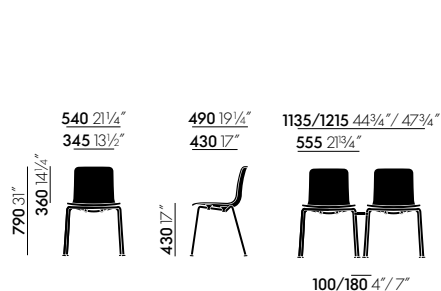

HAL RE Tube Stackable

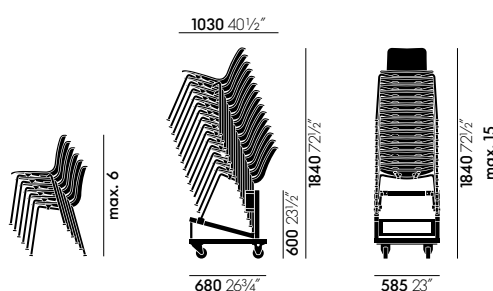

All measurements are pursuant to EN 1335-1:2000

More detailed information is found in the chapter 'Explanation of measurements'.

HAL RE Tube

Seat shell: dyed-through recycled polypropylene, with optional seat cushion (screwed to the seat shell).

Base: four-legged base in tubular steel, non-stackable, chrome-plated or powder-coated in ivory or basic dark. The powder-coated version is suitable for outdoor use.

HAL Ply Tube

Seat shell: plywood (USA).

Base: four-legged base in tubular steel, non-stackable, chrome-plated or powder-coated in ivory or basic dark.

HAL RE Tube Stackable

Seat shell: dyed-through, recycled polypropylene.

Base: stackable four-legged base made of tubular steel, chrome-plated or powder-coated in basic dark. Up to 6 chairs can be stacked on the floor, up to 15 chairs on a stacking trolley.

Note: as stacking can cause scratches, we recommend the chrome version for this purpose.

HAL Ply Tube Stackable

Seat shell: plywood (USA).

Base: stackable four-legged base made of tubular steel, chrome-plated or powder-coated in basic dark. Up to 6 chairs can be stacked on the floor, up to 11 chairs on a stacking trolley.

Note: as stacking can cause scratches, we recommend the chrome version for this purpose.

Glides: colour matched to the small attachment parts for the seat shell, choice of white (except HAL Wood and HAL Ply Wood) or deep black. All bases fitted with glides for carpet; felt glides optionally available for hard floors.

HAL RE Tube	Article no.	without VAT in SEK*	with VAT in SEK*
four-legged tubular steel base, non-stacking	440 502 00		
Base chromed	01	2.520,00	3.150,00
Base powder-coated basic dark, suitable for outdoor use	30	2.520,00	3.150,00
Base powder-coated ivory, suitable for outdoor use	49	2.520,00	3.150,00
four-legged tubular steel base, non-stacking	440 503 00		
Base chromed, with seat upholstery F60	01	3.608,00	4.510,00
Base powder-coated basic dark, with seat upholstery F60	30	3.608,00	4.510,00
Base powder-coated ivory, with seat upholstery F60	49	3.608,00	4.510,00

HAL Ply Tube	Article no.	without VAT in SEK*	with VAT in SEK*
four-legged tubular steel base, non-stacking	440 221 00		
Seat shell natural oak, with protective varnish	01	4.504,00	5.630,00
Seat shell dark oak, with protective varnish	02	4.504,00	5.630,00

HAL RE Tube Stackable	Article no.	without VAT in SEK*	with VAT in SEK*
four-legged tubular steel base, stackable	440 504 00		
Base chromed, without seat upholstery	01	2.832,00	3.540,00
Base basic dark without seat upholstery	30	2.832,00	3.540,00

HAL Ply Tube Stackable	Article no.	without VAT in SEK*	with VAT in SEK*
four-legged tubular steel base, stacking	440 215 00		
Base chrome-plated, Seat shell natural oak, with protective varnish	0101	4.816,00	6.020,00
Base chrome-plated, Seat shell dark oak, with protective varnish	0102	4.816,00	6.020,00
Base powder-coated in basic dark, Seat shell natural oak, with protective varnish	3001	4.816,00	6.020,00
Base powder-coated in basic dark, Seat shell dark oak, with protective varnish	3002	4.816,00	6.020,00

Seat fabric F60	Seat shell HAL RE	Base HAL Ply Tube	Colours (Glides)	Glides
Hopsak	12 deep black RE 14 ivy RE 23 ice grey RE 29 brick RE 31 warm grey RE 35 basalt RE 85 cotton white RE 86 cardboard RE	01 chrome 30 basic dark powder-coated (smooth) 49 ivory powder-coated (textured)	04 white 12 deep black	04 glides for carpet 05 felt glides for hard floor

HAL Soft Wood

Jasper Morrison, 2021

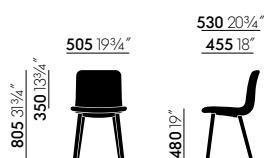

HAL Soft Wood

All measurements are pursuant to EN 1335-1:2000
More detailed information is found in the chapter 'Explanation of measurements'.

HAL Soft Wood

Seat shell: glass-fibre reinforced polyamide. Polyurethane foam padding, replaceable fabric cover (to be carried out by Vitra Service only).

Base: non-stackable wooden base in natural or dark oak.

Seat shell and base connection: die-cast aluminium, powder-coated finish.

HAL Soft Wood

	Article no.	without VAT in SEK*	with VAT in SEK*
wood base, non-stacking	440 485 00		
Seat			
Fabric F30		7.080,00	8.850,00
Fabric F40		7.280,00	9.100,00
Fabric F60		7.672,00	9.590,00
Fabric F80		7.992,00	9.990,00
Fabric F120		8.720,00	10.900,00

Fabric F30	Fabric F40	Fabric F60	Fabric F80	Fabric F120	Glides	Base HAL Wood, HAL Ply Wood, HAL Soft Wood
Plano	Laser RE	Volo	Dumet	Credo	04 glides for carpet 05 felt glides for hard floor	04 dark stained solid oak, with protective varnish 10 natural oak, with protective varnish

HAL Soft Tube

Jasper Morrison, 2021

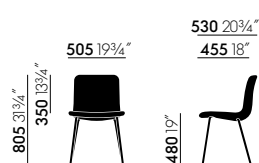

HAL Soft Tube

All measurements are pursuant to EN 1335-1:2000
More detailed information is found in the chapter 'Explanation of measurements'.

HAL Soft Tube

Seat shell: glass-fibre reinforced polyamide. Polyurethane foam padding, replaceable fabric cover (to be carried out by Vitra Service only).

Base: four-legged tubular steel base, chrome-plated finish or powder-coated in basic dark.

HAL Soft Tube

	Article no.	without VAT in SEK*	with VAT in SEK*
four-legged tubular steel base, non-stacking	440 486 00		
Seat			
Fabric F30		5.752,00	7.190,00
Fabric F40		5.960,00	7.450,00
Fabric F60		6.360,00	7.950,00
Fabric F80		6.640,00	8.300,00
Fabric F120		7.400,00	9.250,00

Fabric F30	Fabric F40	Fabric F60	Fabric F80	Fabric F120	Glides	Base
Plano	Laser RE	Volo	Dumet	Credo	04 glides for carpet 05 felt glides for hard floor	01 chrome 30 basic dark powder-coated (textured)

HAL Soft Tube Stackable

Jasper Morrison, 2021



HAL Soft Tube Stackable

All measurements are pursuant to EN 1335-1:2000
More detailed information is found in the chapter 'Explanation of measurements'.

HAL Soft Tube Stackable

Seat shell: glass-fibre reinforced polyamide. Polyurethane foam padding, replaceable fabric cover (to be carried out by Vitra Service only).

Base: stackable four-legged tubular steel base, chrome-plated finish or powder-coated in basic dark. Up to 6 chairs can be stacked on the floor.

HAL Soft Tube Stackable

	Article no.	without VAT in SEK*	with VAT in SEK*
four-legged tubular steel base, stackable	440 487 00		
Seat			
Fabric F30		6.040,00	7.550,00
Fabric F40		6.280,00	7.850,00
Fabric F60		6.632,00	8.290,00
Fabric F80		6.952,00	8.690,00
Fabric F120		7.672,00	9.590,00

Fabric F30	Fabric F40	Fabric F60	Fabric F80	Fabric F120	Glides	Base
Plano	Laser RE	Volo	Dumet	Credo	04 glides for carpet 05 felt glides for hard floor	01 chrome 30 basic dark powder-coated (textured)

HAL

Jasper Morrison, 2010/2014

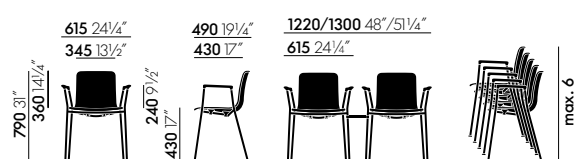

HAL RE Tube Armrest

100/180 4'7"

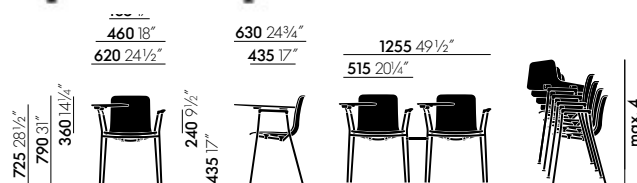

HAL RE Tube Writing Tablet

180 7"

All measurements are pursuant to EN 1335-1:2000

More detailed information is found in the chapter 'Explanation of measurements'.

HAL RE Tube Armrest**Seat shell:** dyed-through, recycled polypropylene.**Base:** four-legged tubular steel base, chrome-plated finish. Up to 6 chairs can be stacked on the floor or on a stacking trolley. Armrest colour matched to seat shell.**HAL RE Tube Writing Tablet****Seat shell:** dyed-through, recycled polypropylene.**Base:** four-legged base in tubular steel, with a foldable tablet desk in black, always mounted on the right (from a seated position). Up to 4 chairs can be stacked on the floor or on a stacking trolley.**Glides:** colour matched to the small attachment parts for the seat shell, choice of white (except HAL Wood and HAL Ply Wood) or deep black. All bases fitted with glides for carpet; felt glides optionally available for hard floors.

HAL RE Tube Armrest	Article no.	without VAT in SEK*	with VAT in SEK*
four-legged tubular steel base, stackable	440 505 00		
Base chromed		3.616,00	4.520,00

HAL RE Tube Writing Tablet	Article no.	without VAT in SEK*	with VAT in SEK*
tubular steel base, stacking	440 506 00		
Base chromed		6.056,00	7.570,00

Seat shell HAL RE	Colours (Glides)	Glides
12 deep black RE	04 white	04 glides for carpet
14 ivy RE	12 deep black	05 felt glides for hard floor
23 ice grey RE		
29 brick RE		
31 warm grey RE		
35 basalt RE		
85 cotton white RE		
86 cardboard RE		

HAL

Jasper Morrison, 2010/2014



HAL RE Sledge

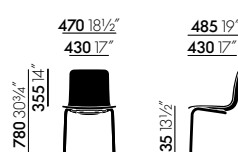

HAL RE Cantilever



All measurements are pursuant to EN 1335-1:2000

More detailed information is found in the chapter 'Explanation of measurements'.

HAL RE Sledge

Seat shell: dyed-through, recycled polypropylene.

Base: sledge base in chrome-plated tubular steel. Up to 6 chairs can be stacked on the floor, up to 13 chairs on a stacking trolley. Also available with row connectors.

HAL RE Cantilever

Seat shell: dyed-through, recycled polypropylene, with optional seat cushion (screwed to the seat shell).

Base: cantilever base in chrome-plated tubular steel, non-stackable.

Glides: colour matched to the small attachment parts for the seat shell, choice of white (except HAL Wood and HAL Ply Wood) or deep black. All bases fitted with glides for carpet; felt glides optionally available for hard floors.

HAL RE Sledge	Article no.	without VAT in SEK*	with VAT in SEK*
sledge tubular steel base, stacking, with row connectors	440 507 00		
Base chromed		3.312,00	4.140,00
sledge tubular steel base, stacking, without row connectors	440 508 00		
Base chromed		2.760,00	3.450,00
HAL RE Cantilever	Article no.	without VAT in SEK*	with VAT in SEK*
cantilever tubular steel base, non-stacking	440 509 00		
Base chromed, without seat upholstery		3.432,00	4.290,00
cantilever tubular steel base, non-stacking	440 510 00		
Base chromed, with seat upholstery F60		4.520,00	5.650,00

Seat fabric F60	Seat shell HAL RE	Colours (Glides)	Glides
Hopsak	12 deep black RE 14 ivy RE 23 ice grey RE 29 brick RE 31 warm grey RE 35 basalt RE 85 cotton white RE 86 cardboard RE	04 white 12 deep black	04 glides for carpet 05 felt glides for hard floor

HAL

Jasper Morrison, 2010/2014

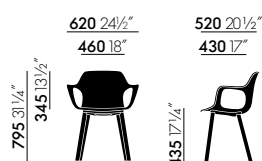

HAL RE Armchair Wood

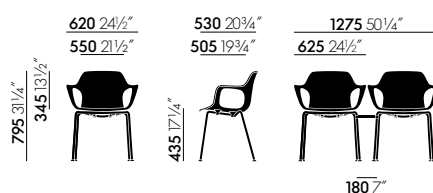

HAL RE Armchair Tube Stackable

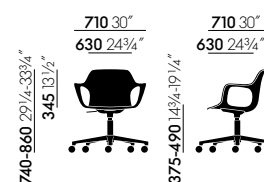

HAL RE Armchair Studio

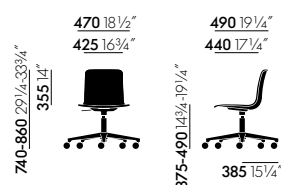

HAL RE Studio

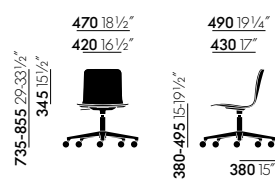

HAL Ply Studio

All measurements are pursuant to EN 1335-1:2000

More detailed information is found in the chapter 'Explanation of measurements'.

HAL RE Armchair Wood

Seat shell: dyed-through, recycled polypropylene, with optional seat cushion (screwed to the seat shell).

Base: non-stackable wooden base in natural or dark oak. Connecting element between shell and base in die-cast aluminium, powder-coated in dim grey.

Origin of wood: oak (*Quercus robur*) from Western Europe and/or Poland.

HAL RE Armchair Tube Stackable

Seat shell: dyed-through, recycled polypropylene.

Base: stackable four-legged tubular steel base, chrome-plated finish or powder-coated in basic dark. Up to 6 chairs can be stacked on the floor or on a stacking trolley. Chairs with seat cushions should not be stacked, since stacking could damage the upholstery.

Note: as stacking can cause scratches, we recommend the chrome version for this purpose.

HAL RE Armchair Studio

Seat shell: dyed-through recycled polypropylene, with optional seat cushion (screwed to the seat shell).

Base: five-star base in die-cast aluminium powder-coated in basic dark. Swivel mechanism with shock-absorbing seat suspension, height-adjustable.

HAL RE Studio

Seat shell: dyed-through, recycled polypropylene.

Base: five-star base in die-cast aluminium powder-coated in basic dark. Swivel mechanism with shock-absorbing seat suspension, height-adjustable.

HAL Ply Studio

Seat shell: plywood (USA).

Base: five-star base in die-cast aluminium powder-coated in basic dark. Swivel mechanism with shock-absorbing seat suspension, height-adjustable.

Glides: colour matched to the small attachment parts for the seat shell, choice of white (except HAL Wood and HAL Ply Wood) or deep black. All bases fitted with glides for carpet; felt glides optionally available for hard floors.

HAL RE Armchair Wood	Article no.	without VAT in SEK*	with VAT in SEK*
wood base, non-stacking	440 511 00		
Base natural oak, with protective varnish, without seat upholstery	10	5.736,00	7.170,00
Base dark oak, with protective varnish, without seat upholstery	04	5.736,00	7.170,00
wood base, non-stacking	440 512 00		
Base natural oak, with protective varnish, with seat upholstery F60	10	6.824,00	8.530,00
Base dark oak, with protective varnish, with seat upholstery F60	04	6.824,00	8.530,00

HAL RE Armchair Tube Stackable	Article no.	without VAT in SEK*	with VAT in SEK*
four-legged tubular steel base, stackable	440 513 00		
Base chromed, without seat upholstery	01	4.192,00	5.240,00
Base basic dark without seat upholstery	30	4.192,00	5.240,00
four-legged tubular steel base, non-stacking	440 514 00		
Base chromed, with seat upholstery F60	01	4.968,00	6.210,00
Base basic dark, with seat upholstery F60	30	4.968,00	6.210,00

HAL RE Armchair Studio	Article no.	without VAT in SEK*	with VAT in SEK*
five-star base	440 515 00		
Base powder-coated basic dark, without seat upholstery		4.976,00	6.220,00
five-star base	440 516 00		
Base powder-coated basic dark, with seat upholstery F60		6.064,00	7.580,00

HAL RE Studio	Article no.	without VAT in SEK*	with VAT in SEK*
five-star base	440 517 00		
Base powder-coated basic dark, without seat upholstery		4.376,00	5.470,00
five-star base	440 518 00		
Base powder-coated basic dark, with seat upholstery F60		5.464,00	6.830,00

HAL Ply Studio	Article no.	without VAT in SEK*	with VAT in SEK*
five-star base	440 229 00		
Base powder-coated basic dark, seat shell natural oak, with protective varnish	01	6.360,00	7.950,00
Base powder-coated basic dark, seat shell dark oak, with protective varnish	02	6.360,00	7.950,00

Seat fabric F60	Seat shell HAL RE	Colours (Glides)	Glides	Castors
Hopsak	12 deep black RE 14 ivy RE 23 ice grey RE 29 brick RE 31 warm grey RE 35 basalt RE 85 cotton white RE 86 cardboard RE	04 white 12 deep black	04 glides for carpet 05 felt glides for hard floor	02 castors hard, braked for carpet 03 castors soft, braked for hard floor

HAL

Jasper Morrison, 2010/2014



HAL RE Stool Medium

HAL RE Stool High

HAL Ply Stool High

HAL Ply Stool Medium

All measurements are pursuant to EN 1335-1:2000
 More detailed information is found in the chapter 'Explanation of measurements'.

HAL RE Stool Medium

Seat shell: dyed-through, recycled polypropylene, with optional seat cushion (screwed to the seat shell).

Base: chrome-plated tubular steel, non-stackable.

HAL RE Stool High

Seat shell: dyed-through, recycled polypropylene, with optional seat cushion (screwed to the seat shell).

Base: chrome-plated tubular steel with anti-skid footrest, non-stacking.

HAL Ply Stool Medium

Seat shell: plywood (USA).

Base: chrome-plated tubular steel, non-stackable.

HAL Ply Stool High

Seat shell: plywood (USA).

Base: chrome-plated tubular steel with anti-skid footrest, non-stacking.

Glides: colour matched to the small attachment parts for the seat shell, choice of white (except HAL Wood and HAL Ply Wood) or deep black. All bases fitted with glides for carpet; felt glides optionally available for hard floors.

HAL RE Stool Medium	Article no.	without VAT in SEK*	with VAT in SEK*
bar stool, four-legged tubular steel base, non-stacking	440 519 00		
Base chromed, without seat upholstery		3.312,00	4.140,00
bar stool, four-legged tubular steel base, non-stacking	440 520 00		
Base chromed, with seat upholstery F60		4.400,00	5.500,00

HAL RE Stool High	Article no.	without VAT in SEK*	with VAT in SEK*
bar stool, four-legged tubular steel base, non-stacking	440 521 00		
Base chromed, without seat upholstery		3.912,00	4.890,00
bar stool, four-legged tubular steel base, non-stacking	440 522 00		
Base chromed, with seat upholstery F60		5.000,00	6.250,00

HAL Ply Stool Medium	Article no.	without VAT in SEK*	with VAT in SEK*
bar stool, four-legged tubular steel base, non-stacking	440 224 00		
Seat shell natural oak, with protective varnish	01	5.296,00	6.620,00
Seat shell dark oak, with protective varnish	02	5.296,00	6.620,00

HAL Ply Stool High	Article no.	without VAT in SEK*	with VAT in SEK*
bar stool, four-legged tubular steel base, non-stacking	440 223 00		
Seat shell natural oak, with protective varnish	01	5.896,00	7.370,00
Seat shell dark oak, with protective varnish	02	5.896,00	7.370,00

Seat fabric F60	Seat shell HAL RE	Colours (Glides)	Glides
Hopsak	12 deep black RE 14 ivy RE 23 ice grey RE 29 brick RE 31 warm grey RE 35 basalt RE 85 cotton white RE 86 cardboard RE	04 white 12 deep black	04 glides for carpet 05 felt glides for hard floor

HAL

Jasper Morrison, 2010/2014

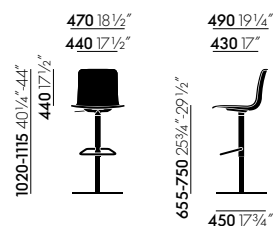

HAL RE Barstool

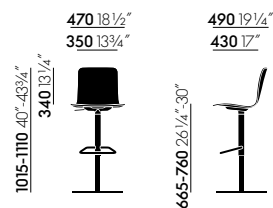

HAL Ply Barstool

All measurements are pursuant to EN 1335-1:2000
More detailed information is found in the chapter 'Explanation of measurements'.

HAL RE Barstool

Seat shell: dyed-through recycled polypropylene, swivel mechanism, with optional seat cushion (screwed to the seat shell).

Base: height-adjustable tubular steel pedestal, gas spring powder-coated in basic dark, column sleeve and footrest in chrome-plated tubular steel with anti-skid surface. Seat shell and base connection in die-cast aluminium, powder-coated in dim grey. Steel base plate with brushed stainless steel cover (matt); felt bottom.

HAL Ply Barstool

Seat shell: plywood (USA); swivel mount.

Base: height-adjustable tubular steel pedestal, gas spring powder-coated in basic dark, column sleeve and footrest in chrome-plated tubular steel with anti-skid surface. Connecting element between shell and base in die-cast aluminium, powder-coated in dim grey. Steel base plate with brushed stainless steel cover (matt); felt bottom.

HAL RE Barstool

	Article no.	without VAT in SEK*	with VAT in SEK*
Height-adjustable bar stool	440 523 00		
Tubular steel base, powder-coated basic dark, without seat upholstery		6.664,00	8.330,00
Height-adjustable bar stool	440 524 00		
Tubular steel base, powder-coated basic dark, with seat upholstery F60		7.752,00	9.690,00

HAL Ply Barstool

	Article no.	without VAT in SEK*	with VAT in SEK*
Height-adjustable bar stool	440 227 00		
Tubular steel base, powder-coated in basic dark			
Seat shell natural oak, with protective varnish	01	8.648,00	10.810,00
Seat shell dark oak, with protective varnish	02	8.648,00	10.810,00

Seat fabric F60**Seat shell HAL RE**

Hopsak	12 deep black RE
	14 ivy RE
	23 ice grey RE
	29 brick RE
	31 warm grey RE
	35 basalt RE
	85 cotton white RE
	86 cardboard RE

HAL

Jasper Morrison, 2010/2014

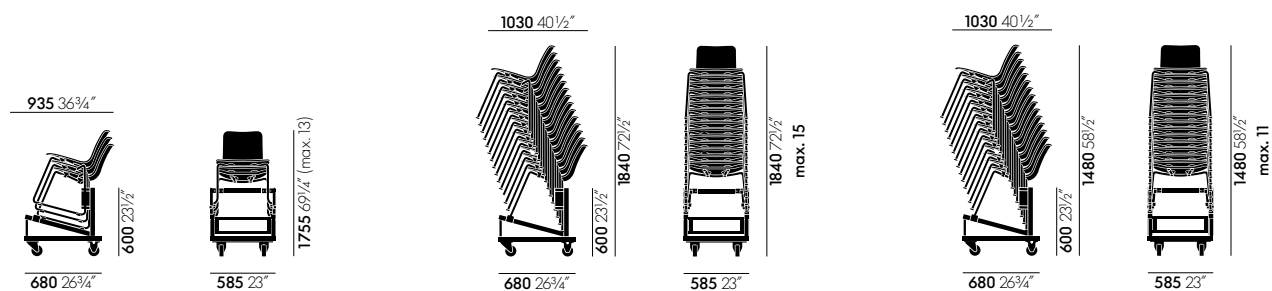

HAL RE Sledge

HAL RE Tube Stackable

HAL Ply Tube Stackable

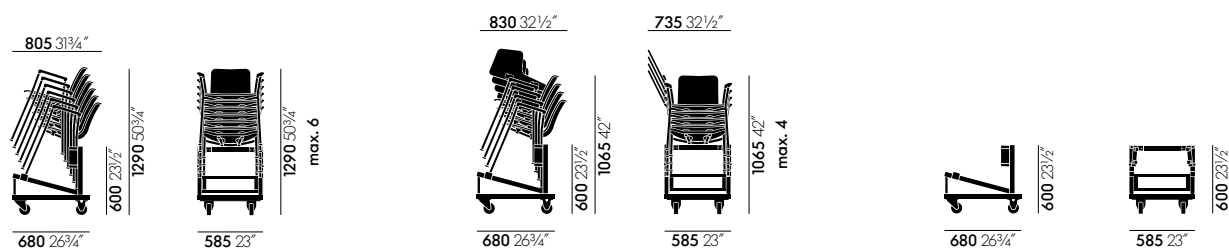

HAL RE Tube Armrest

HAL RE Tube Writing Tablet

HAL Stacking dolly

All measurements are pursuant to EN 1335-1:2000

More detailed information is found in the chapter 'Explanation of measurements'.

HAL Stacking Trolley

HAL Stacking Trolley is suitable for use with all stackable HAL models, with the exception of HAL Soft Tube stackable.

HAL seat cover

The fabric covers for the seat shells of HAL and HAL Ply provide enhanced comfort. They are available in various colours and can be easily attached and removed.

HAL seat cover: 100% polyester/polyurethane; two reverse flaps fit over top of backrest and front of seat. Available in Plano fabric in predefined colours (see Price List supplement for upholstery materials). Additional colours in the Plano collection can be selected for orders of 6 or more seat covers.

HAL row connector

The HAL row connector is a linking element in two sizes: 100 mm for a smaller and 180 mm for a larger distance between the chairs. The number clips of the linking elements for the .03 also match the new HAL linking element.

For the following HAL chairs, the linking elements can be used in both sizes:

- HAL RE Tube Stackable
- HAL Ply Tube Stackable
- HAL RE Tube Armrest

For the following HAL chairs, only the linking element of 180 mm can be used:

- HAL RE Armchair Tube Stackable
- HAL RE Tube Writing Tablet

HAL

Jasper Morrison, 2010/2014

vitra.

HAL Stacking Trolley		Article no.	without VAT in SEK*	with VAT in SEK*
Trolley suited for all stackable HAL chair models		440 219 00	12.904,00	16.130,00
HAL Seat Cover		Article no.	without VAT in SEK*	with VAT in SEK*
		440 209 00		
Plano			1.312,00	1.640,00
HAL Ply seat cover		Article no.	without VAT in SEK*	with VAT in SEK*
		440 225 00		
Plano			1.312,00	1.640,00
HAL row connector		Article no.	without VAT in SEK*	with VAT in SEK*
row connector, 100 mm, set of 10	plastic, basic dark	442 045 00	616,00	770,00
row connector, 180 mm, set of 10	plastic, basic dark	442 046 00	696,00	870,00
Number clips		Article no.	without VAT in SEK*	with VAT in SEK*
Set of 10 items		442 044 00		
		01	176,00	220,00

Seat cover, Plano

05 cream white/sierra grey
07 orange
12 light grey/ice blue
54 brown
69 dark grey
84 poppy red/champagne

ID Visitor

Antonio Citterio, 2021



ID Visitor Air



ID Visitor Mesh

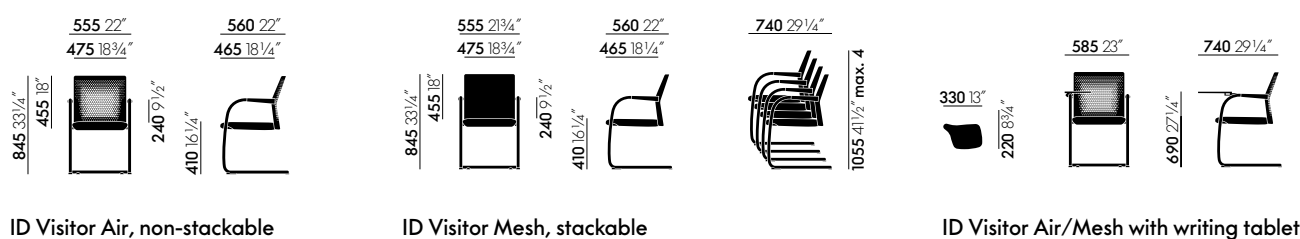

ID Visitor Air, non-stackable

ID Visitor Mesh, stackable

ID Visitor Air/Mesh with writing tablet

All measurements are pursuant to EN 1335-1:2000
More detailed information is found in the chapter 'Explanation of measurements'.

ID Visitor Air

Backrest: perforated plastic backrest in basic dark or soft grey, unupholstered. Armrests made of polypropylene in basic dark or dim grey.

Seat cushion: polyurethane foam or optional PU-foam-free padding (F). Seat cover in fabric or leather.

Base: tubular steel cantilever base, in chrome or powder-coated in basic dark or soft grey. Can be stacked (max. 4 chairs).

Note: as stacking can cause scratches, we recommend the chrome version for this purpose. In the stackable version, the seat cover is in basic dark (with armrests in basic dark) or soft grey (with armrests in dim grey).

Optional accessory: a multipurpose folding desk tablet in black plastic is available for the version in chrome.

ID Visitor Mesh

Backrest: plastic backrest covered with 3D spacer fabric; double seam around the edge. Armrests made of polypropylene in basic dark or dim grey.

Seat cushion: polyurethane foam or optional PU-foam-free padding (F). Seat cover in woven fabric or 3D spacer fabric.

Base: tubular steel cantilever base, in chrome or powder-coated in basic dark or soft grey. Can be stacked (max. 4 chairs).

Note: as stacking can cause scratches, we recommend the chrome version for this purpose. In the stackable version, the seat cover is in basic dark (with armrests in basic dark) or soft grey (with armrests in dim grey).

Optional accessory: a multipurpose folding desk tablet in black plastic is available for the version in chrome.

ID Visitor

Antonio Citterio, 2021

ID Visitor Air	Article no.	without VAT in SEK*	with VAT in SEK*
	431 500 00		
Seat Silk Mesh		4.064,00	5.080,00
Seat fabric F30		4.064,00	5.080,00
Seat fabric F40		4.112,00	5.140,00
Seat fabric F60		4.304,00	5.380,00
Seat leather L20		6.592,00	8.240,00
Surcharges upholstery			
standard	01	0,00	0,00
polyurethane foam free (F) (in Plano, Silk Mesh or Reflect)	02	568,00	710,00
Surcharges base			
powder-coated, non-stackable	11	0,00	0,00
chromed, non-stackable	12	616,00	770,00
powder-coated, stackable	13	0,00	0,00
chromed, stackable	14	616,00	770,00

ID Visitor Mesh	Article no.	without VAT in SEK*	with VAT in SEK*
	431 501 00		
Backrest Diamond Mesh, seat Silk Mesh		4.728,00	5.910,00
Backrest Diamond Mesh, seat fabric F30		4.728,00	5.910,00
Backrest Diamond Mesh, seat fabric F40		4.792,00	5.990,00
Backrest Diamond Mesh, seat fabric F60		4.976,00	6.220,00
Surcharges upholstery			
standard	01	0,00	0,00
polyurethane foam free (F) (in Plano, Silk Mesh or Reflect)	02	568,00	710,00
Surcharges base			
powder-coated, non-stackable	11	0,00	0,00
chromed, non-stackable	12	616,00	770,00
powder-coated, stackable	13	0,00	0,00
chromed, stackable	14	616,00	770,00

Universal writing tablet	Article no.	without VAT in SEK*	with VAT in SEK*	
Right side	black plastic	416 242 00	2.040,00	2.550,00

Fabric F30	Fabric F40	Fabric F60	Leather L20	Backrest ID Visitor Air	Armrests	Base coated	Glides
. Plano	. Laser RE . Reflect	. Volo	. Leather	30 basic dark 53 soft grey	21 dim grey 30 basic dark	30 basic dark powder-coated (textured) 53 soft grey powder-coated (textured)	04 glides for carpet 05 felt glides for hard floor

ID Visitor

Antonio Citterio, 2021



ID Visitor Soft

ID Visitor Trim

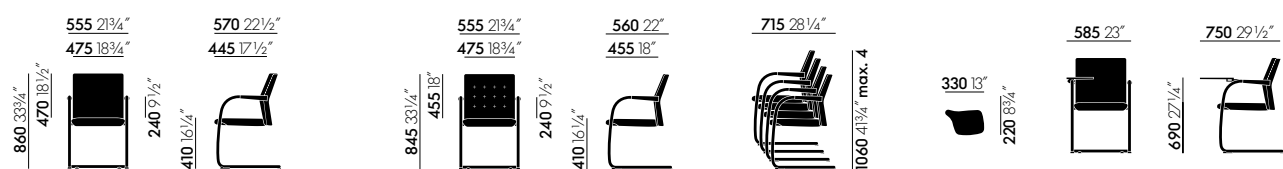

ID Visitor Soft, non-stackable

ID Visitor Trim, stackable

ID Visitor Soft/Trim with writing tablet

All measurements are pursuant to EN 1335-1:2000
More detailed information is found in the chapter 'Explanation of measurements'.

ID Visitor Soft

Backrest: plastic backrest with soft polyurethane or polyurethane-free padding; fabric or leather cover. The version in leather has a double seam in the centre. Armrests made of polypropylene in basic dark or dim grey.

Seat cushion: polyurethane foam or optional PU-foam-free padding (F). Seat and back covers in fabric or leather.

Base: tubular steel cantilever base, in chrome or powder-coated in basic dark or soft grey. Can be stacked (max. 4 chairs).

Note: as stacking can cause scratches, we recommend the chrome version for this purpose. In the stackable version, the seat cover is in basic dark (with armrests in basic dark) or soft grey (with armrests in dim grey).

Optional accessory: a multipurpose folding desk tablet in black plastic is available for the version in chrome.

ID Visitor Trim

Backrest: plastic backrest with polyurethane or polyurethane-free padding; fabric cover with double seam around the edge. Armrests made of polypropylene in basic dark or dim grey.

Seat cushion: polyurethane foam or optional PU-foam-free padding (F). Seat and back covers in fabric.

Base: tubular steel cantilever base, in chrome or powder-coated in basic dark or soft grey. Can be stacked (max. 4 chairs).

Note: as stacking can cause scratches, we recommend the chrome version for this purpose. In the stackable version, the seat cover is in basic dark (with armrests in basic dark) or soft grey (with armrests in dim grey).

Optional accessory: a multipurpose folding desk tablet in black plastic is available for the version in chrome.

ID Visitor

Antonio Citterio, 2021

ID Visitor Soft	Article no.	without VAT in SEK*	with VAT in SEK*
	431 502 00		
Backrest and seat fabric F30		5.392,00	6.740,00
Backrest and seat fabric F40		5.544,00	6.930,00
Backrest and seat fabric F60		5.936,00	7.420,00
Backrest and seat leather L20		10.080,00	12.600,00

Surcharges upholstery

standard	01	0,00	0,00
polyurethane foam free (F) (in Plano, Silk Mesh or Reflect)	02	928,00	1.160,00

Surcharges base

powder-coated, non-stackable	11	0,00	0,00
chromed, non-stackable	12	616,00	770,00
powder-coated, stackable	13	0,00	0,00
chromed, stackable	14	616,00	770,00

ID Visitor Trim	Article no.	without VAT in SEK*	with VAT in SEK*
	431 503 00		
Backrest and seat fabric F30		5.392,00	6.740,00
Backrest and seat fabric F40		5.544,00	6.930,00
Backrest and seat fabric F60		5.936,00	7.420,00

Surcharges upholstery

standard	01	0,00	0,00
polyurethane foam free (F) (in Plano, Silk Mesh or Reflect)	02	928,00	1.160,00

Surcharges base

powder-coated, non-stackable	11	0,00	0,00
chromed, non-stackable	12	616,00	770,00
powder-coated, stackable	13	0,00	0,00
chromed, stackable	14	616,00	770,00

Universal writing tablet	Article no.	without VAT in SEK*	with VAT in SEK*
Right side	black plastic	416 242 00	2.040,00
			2.550,00

Fabric F30	Fabric F40	Fabric F60	Leather L20	Armrests	Base coated	Glides
. Plano	. Laser RE . Reflect	. Volo	. Leather	21 dim grey 30 basic dark	30 basic dark powder-coated (textured) 53 soft grey powder-coated (textured)	04 glides for carpet 05 felt glides for hard floor

Landi Chair

Hans Coray, 1938

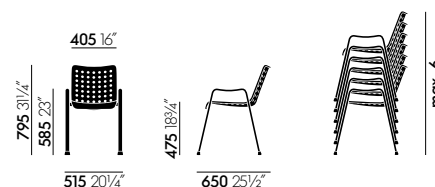

All measurements are pursuant to EN 1335-1:2000
More detailed information is found in the chapter 'Explanation of measurements'.

Seat shell: seat shell in pressed aluminium sheeting with 91 punched holes, matte anodised surface.

Base: armrests and legs from bent aluminium profiles, with welded aluminium cross braces, matt anodised surface.

Glides: glides in light grey injection-moulded TPE.

Applications: ideal for outdoor use in both private and public spaces, such as home patios or balconies, restaurant terraces, open-air cafés etc.

Note: as in the original design, the Landi Chair can be stacked up to 6 units high. Vitra's re-edition of the classic stays true to the original while making the most of the latest technical possibilities. The anodised aluminium surface of the chair is durable and weather-resistant but may develop signs of wear and tear if the chairs are stacked.

Landi Chair

	Article no.	without VAT in SEK*	with VAT in SEK*
aluminium anodized matt	440 270 00	8.080,00	10.100,00

Lobby Chair

Charles & Ray Eames, 1960



ES 105



ES 108

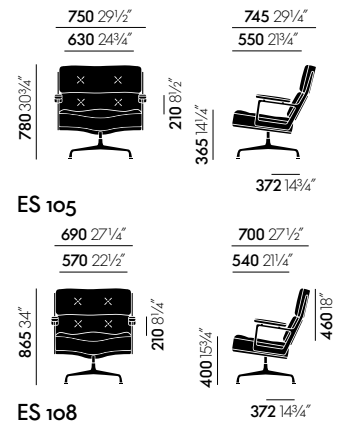

All measurements are pursuant to EN 1335-1:2000
 More detailed information is found in the chapter 'Explanation of measurements'.

ES 105

Furniture type: lounge chair

Backrest and seat: side frames in chrome-plated die-cast aluminium. Cushion elements covered in leather. Fixed seat height, swivel seat.

Armrests: upholstered in leather.

Base: four-star base in chrome-plated die-cast aluminium.

ES 108

Furniture type: conference chair

Backrest and seat: side frames in chrome-plated die-cast aluminium. Cushion elements covered in leather. Fixed seat height, swivel seat.

Armrests: upholstered in leather.

Base: four-star base in chrome-plated die-cast aluminium.

ES 105

	Article no.	without VAT in SEK*	with VAT in SEK*
swivel	412 078 00		
with armrests			
Leather L20		67.200,00	84.000,00
Leather L50		72.400,00	90.500,00

ES 108

	Article no.	without VAT in SEK*	with VAT in SEK*
swivel	412 079 00		
with armrests			
Leather L20		65.760,00	82.200,00
Leather L50		70.720,00	88.400,00

Leather L20

Leather

Leather L50

Leather Premium F

Glides

04 glides for carpet
 05 felt glides for hard floor

Moca

Jasper Morrison, 2020

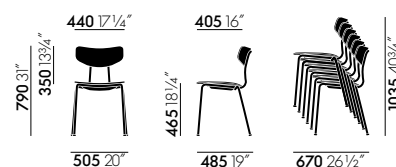

All measurements are pursuant to EN 1335-1:2000
More detailed information is found in the chapter 'Explanation of measurements'.

Seat and backrest: moulded plywood veneer in natural oak (Germany) or dark-stained oak (USA), protective natural lacquer finish.

Base: stackable metal base (up to 6 chairs), chrome-plated or powder-coated finish.

Moca	Article no.	without VAT in SEK*	with VAT in SEK*
	210 649 00		
Oak, with protective varnish		4.560,00	5.700,00

Backrest and seat	Base	Glides
04 dark oak, with protective varnish	01 chrome	04 glides for carpet
10 natural oak, with protective varnish	30 basic dark powder-coated (textured)	05 felt glides for hard floor

MedaSlim

Alberto Meda, 2004



MedaSlim without armrests, stacking



MedaSlim without armrests, stacking



MedaSlim with armrests, stacking

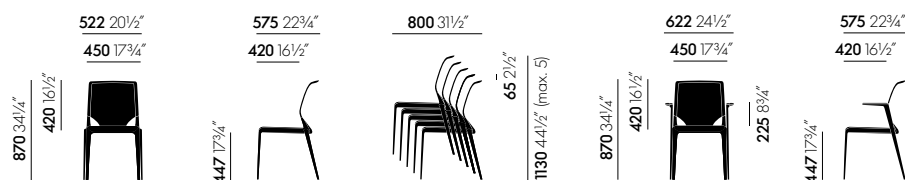

All measurements are pursuant to EN 1335-1:2000
More detailed information is found in the chapter 'Explanation of measurements'.

Backrest: netweave sling cover (Netline).

Seat upholstery: polyurethane foam padding with fabric or leather cover.

Armrests: die-cast aluminium with polished or chrome-plated finish or powder-coated in basic dark.

Base and backrest: backrest frame, front legs and seat shell moulded from a single piece of fibreglass-reinforced polyamide (basic dark). Back legs in aluminium with polished or chrome-plated finish or powder-coated in basic dark.

Note: only MedaSlim chairs with chrome-plated legs are suitable for stacking (up to 5 chairs). The polished and powder-coated versions should not be stacked as this could scratch the surface.

MedaSlim

Alberto Meda, 2004

vitra.

MedaSlim	Article no.	without VAT in SEK*	with VAT in SEK*
without armrests	417 301 00		
Seat fabric F20, backrest Netline		5.488,00	6.860,00
Seat fabric F30, backrest Netline		5.600,00	7.000,00
Seat leather L20, backrest Netline		8.136,00	10.170,00
Surcharges base			
coated	0	0,00	0,00
polished	1	528,00	660,00
chromed (stackable)	2	1.296,00	1.620,00
with armrests	417 302 00		
Seat fabric F20, backrest Netline		6.384,00	7.980,00
Seat fabric F30, backrest Netline		6.472,00	8.090,00
Seat leather L20, backrest Netline		9.032,00	11.290,00
Surcharges base			
coated	0	0,00	0,00
polished	1	528,00	660,00
chromed (stackable)	2	1.296,00	1.620,00

Number clips	Article no.	without VAT in SEK*	with VAT in SEK*
Set of 10 items	442 044 00		
	01	176,00	220,00

Fabric F20	Fabric F30	Leather L20	Glides	Number clips
. Nova	. Plano	. Leather	04 glides for carpet 05 felt glides for hard floor	01 numbers (1 set 1-10) 02 numbers (1 set 11-20) 03 numbers (1 set 21-30) 04 numbers (1 set 31-40) 05 numbers (1 set 41-50)

Organic Chair

Charles Eames & Eero Saarinen, 1940

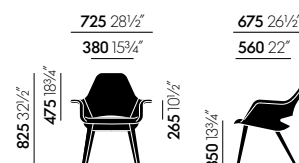

Organic Chair

All measurements are pursuant to EN 1335-1:2000
More detailed information is found in the chapter 'Explanation of measurements'.

Seat shell: laminated.

Upholstery: polyurethane foam with fabric cover.

Legs: black ash or natural oak.

Glides: fitted with plastic glides for carpet, felt glides for hard floors additionally included.

Origin of wood: oak (*Quercus robur*) and ash (*Fraxinus excelsior*) from Western Europe and/or Poland.

Organic Chair

	Article no.	without VAT in SEK*	with VAT in SEK*
	210 010 00		
Fabric F60		18.800,00	23.500,00
Fabric F80		19.600,00	24.500,00
Fabric F100		20.320,00	25.400,00
Fabric F120		21.120,00	26.400,00

Fabric F60

. Hopsak

Fabric F80

. Cosy 2

Fabric F100

. Tonus

Fabric F120

. Credo

Legs

10 natural oak, with protective varnish
68 black ash

Organic Conference

Charles Eames & Eero Saarinen, 1940

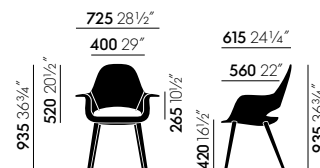

Organic Conference

All measurements are pursuant to EN 1335-1:2000
More detailed information is found in the chapter 'Explanation of measurements'.

Seat shell: laminated.

Upholstery: polyurethane foam with fabric cover.

Legs: black ash or natural oak.

Glides: fitted with plastic glides for carpet, felt glides for hard floors additionally included.

Origin of wood: oak (*Quercus robur*) and ash (*Fraxinus excelsior*) from Western Europe and/or Poland.

Organic Conference

	Article no.	without VAT in SEK*	with VAT in SEK*
	210 011 00		
Fabric F60		18.800,00	23.500,00
Fabric F80		19.600,00	24.500,00
Fabric F100		20.320,00	25.400,00
Fabric F120		21.120,00	26.400,00

Fabric F60

· Hopsak

Fabric F80

· Cosy 2

Fabric F100

· Tonus

Fabric F120

· Credo

Legs

10 natural oak, with protective varnish
68 black ash

Panton Chair Classic

Verner Panton, 1959

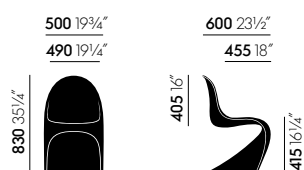

All measurements are pursuant to EN 1335-1:2000
More detailed information is found in the chapter 'Explanation of measurements'.

Shell: rigid polyurethane foam.

Surface: glossy lacquer finish.

Panton Chair Classic

	Article no.	without VAT in SEK*	with VAT in SEK*
Polyurethane	406 001 00		
lacquered	00	14.080,00	17.600,00

Seat shell

11 white
12 black
15 red
42 green

Panton Chair

Verner Panton, 1999

vitra.

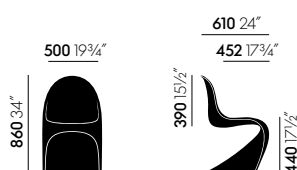

All measurements are pursuant to EN 1335-1:2000
More detailed information is found in the chapter 'Explanation of measurements'.

Back, seat and base: dyed-through polypropylene, 100% recyclable. Matt finish. Suited for outdoor use.

Note: special additives retard the fading of colours due to UV radiation. However, if the chair is exposed to sunlight for prolonged periods, the colour may change over time. We recommend limited exposure to sunlight.

Panton Chair (new height)

	Article no.	without VAT in SEK*	with VAT in SEK*
polypropylene	440 035 00		
		3.032,00	3.790,00

 Quickship

Panton Chair

	Article no.	without VAT in SEK*	with VAT in SEK*
Chair in white	QS4 003 5A	3.032,00	3.790,00

Seat shell

- 04 white
- 12 deep black
- 28 classic red
- 37 glacier blue
- 41 pale rose
- 57 soft mint
- 98 bordeaux

Panton Junior

Verner Panton, 1959/1960

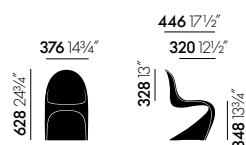

All measurements are pursuant to EN 1335-1:2000
More detailed information is found in the chapter 'Explanation of measurements'.

Back, seat and base: dyed-through polypropylene. Matt finish. Suited for outdoor use.

Note: special additives retard the fading of colours due to UV radiation. However, if the chair is exposed to sunlight for prolonged periods, the colour may change over time. We recommend limited exposure to sunlight.

Safety information: chair suitable for children aged 3 to 10 and for max. 34 kg (74 lbs). For children under the age of 3, there is an increased risk of a fall or of the chair tipping over. Do not let your child climb on the chair. Always make sure the chair is used in a safe place. A chair standing by a window, for example, may result in a child falling from a dangerous height.



Panton Junior
classic red
210 196 18
SEK* 1.680,00 / **2.100,00**



Panton Junior
soft mint
210 196 05
SEK* 1.680,00 / **2.100,00**



Panton Junior
sea blue
210 196 06
SEK* 1.680,00 / **2.100,00**



Panton Junior
white
210 196 04
SEK* 1.680,00 / **2.100,00**



Panton Junior
pale rose
210 196 07
SEK* 1.680,00 / **2.100,00**



Panton Junior
golden yellow
210 196 08
SEK* 1.680,00 / **2.100,00**

Plywood Group

Charles & Ray Eames, 1945/1946

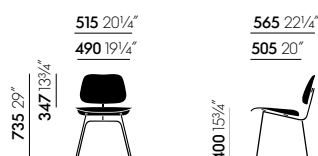

DCM



DCW

All measurements are pursuant to EN 1335-1:2000
More detailed information is found in the chapter 'Explanation of measurements'.

DCM = Dining Chair Metal

Back/seat: moulded plywood with face veneer in ash or walnut.

Base: tubular steel, chrome-plated or powder-coated. Seat and backrest attached to the base with shock mounts (bonded rubber and metal connectors).

DCW = Dining Chair Wood

Back/seat: moulded plywood with face veneer in ash or walnut.

Base: moulded plywood with same face veneer as the back and seat. Seat and backrest attached to the base with shock mounts (bonded rubber and metal connectors).

DCM	Article no.	without VAT in SEK*	with VAT in SEK*
	210 546 00		
natural ash (new)	64	9.120,00	11.400,00
black ash	68	9.120,00	11.400,00
black-pigmented walnut	45	10.080,00	12.600,00

DCW	Article no.	without VAT in SEK*	with VAT in SEK*
	210 547 00		
natural ash (new)	64	15.200,00	19.000,00
black ash	68	15.200,00	19.000,00
black-pigmented walnut	45	17.520,00	21.900,00

Base (DCM, LCM)

01 chrome
30 basic dark powder-coated (smooth)

Glides (DCM, LCM)

04 glides for carpet
05 felt glides for hard floor

Plywood Group

Charles & Ray Eames, 1945/1946

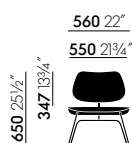

LCM

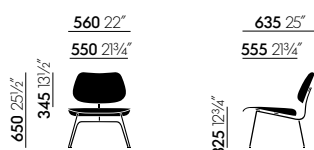

LCM Calf's Skin

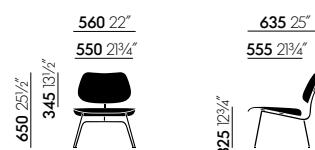

LCM Leather

All measurements are pursuant to EN 1335-1:2000
More detailed information is found in the chapter 'Explanation of measurements'.

LCM = Lounge Chair Metal

Back/seat: moulded plywood with face veneer in ash or walnut.

Upholstery: thin foam padding, covered in leather (LCW Leather) or calfskin hide (LCW Calf's Skin).

Base: tubular steel, chrome-plated or powder-coated. Seat and backrest attached to the base with shock mounts (bonded rubber and metal connectors).

LCM

	Article no.	without VAT in SEK*	with VAT in SEK*
			210 548 00
natural ash (new)	64	9.600,00	12.000,00
black ash	68	9.600,00	12.000,00
black-pigmented walnut	45	10.480,00	13.100,00

LCM Calf's Skin

	Article no.	without VAT in SEK*	with VAT in SEK*
			210 549 00
natural ash (new), hide brown / white	64	21.360,00	26.700,00
black ash, hide black / white	68	21.360,00	26.700,00

LCM Leather

	Article no.	without VAT in SEK*	with VAT in SEK*
			210 550 00
natural ash (new), leather nero	64	19.120,00	23.900,00
black ash, leather nero	68	19.120,00	23.900,00
black-pigmented walnut, leather nero	45	20.000,00	25.000,00

Base (DCM, LCM)

01 chrome
30 basic dark powder-coated (smooth)

Glides (DCM, LCM)

04 glides for carpet
05 felt glides for hard floor

Plywood Group

Charles & Ray Eames, 1945/1946



LCW



LCW Calf's Skin



LCW Leather

All measurements are pursuant to EN 1335-1:2000
More detailed information is found in the chapter 'Explanation of measurements'.

LCW = Lounge Chair Wood

Back/seat: moulded plywood with face veneer in ash or walnut.

Upholstery: thin foam padding, covered in leather (LCW Leather) or calfskin hide (LCW Calf's Skin).

Base: moulded plywood with same face veneer as the back and seat. Seat and backrest attached to the base with shock mounts (bonded rubber and metal connectors).

LCW

	Article no.	without VAT in SEK*	with VAT in SEK*
			210 551 00
natural ash	64	15.200,00	19.000,00
black ash	68	15.200,00	19.000,00
black-pigmented walnut	45	17.520,00	21.900,00

LCW Calf's Skin

	Article no.	without VAT in SEK*	with VAT in SEK*
			210 552 00
natural ash (new), hide brown / white	64	27.360,00	34.200,00
black ash, hide black / white	68	27.360,00	34.200,00

LCW Leather

	Article no.	without VAT in SEK*	with VAT in SEK*
			210 553 00
natural ash (new), leather nero	64	25.120,00	31.400,00
black ash, leather nero	68	25.120,00	31.400,00
black-pigmented walnut, leather nero	45	27.520,00	34.400,00

Softshell Chair

Ronan & Erwan Bouroullec, 2008

vitra.



Softshell Chair four-legged base



Softshell Chair four-star base

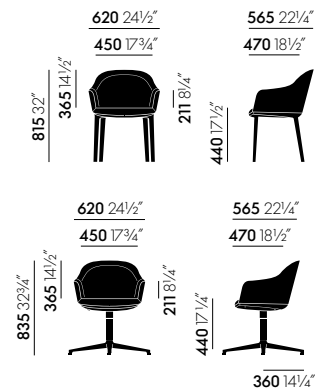

All measurements are pursuant to EN 1335-1:2000
More detailed information is found in the chapter 'Explanation of measurements'.

Backrest and seat: flexible upper backrest shell. Seat and backrest shell in fibreglass-reinforced polyamide. Seat and backrest upholstery in polyurethane foam. Armrests are integrated in the seat shell. Version in Laser fabric and in leather with two seams along the sides of the backrest.

Four-legged base: polyamide in basic dark with glides.

Backrest and seat: flexible upper backrest shell. Seat and backrest shell in fibreglass-reinforced polyamide. Seat and backrest upholstery in polyurethane foam. Armrests are integrated in the seat shell. With two seams along the sides of the backrest.

Four-star base: aluminium powder-coated in basic dark or with polished finish (swivel function with comfortable seat depth suspension).

Softshell Chair

	Article no.	without VAT in SEK*	with VAT in SEK*
Four-legged base	423 006 00		
Fabric F30		7.160,00	8.950,00
Fabric F40		7.480,00	9.350,00
Fabric F60		7.920,00	9.900,00
Fabric F80		8.400,00	10.500,00
Fabric F100		8.880,00	11.100,00
Fabric F120		9.520,00	11.900,00
Leather L20		15.040,00	18.800,00
Leather L50		18.720,00	23.400,00

Softshell Chair

	Article no.	without VAT in SEK*	with VAT in SEK*
Four-star base	423 007 00		
Fabric F30		10.080,00	12.600,00
Fabric F40		10.240,00	12.800,00
Fabric F60		10.720,00	13.400,00
Fabric F80		11.280,00	14.100,00
Fabric F100		12.000,00	15.000,00
Fabric F120		12.560,00	15.700,00
Leather L20		17.680,00	22.100,00
Leather L50		21.440,00	26.800,00
Surcharges base			
aluminium base, powder-coated in basic dark	2	0,00	0,00
aluminium base, polished	3	456,00	570,00

Fabric F30	Fabric F40	Fabric F60	Fabric F80	Fabric F100	Fabric F120	Leather L20	Leather L50	Glides
Plano	Laser RE	Twill Volo	Dumet Linho Tress	Aura Reed	Credo	Leather	Leather Premium F	04 glides for carpet 05 felt glides for hard floor

Softshell Chair

Ronan & Erwan Bouroullec, 2008

vitra.

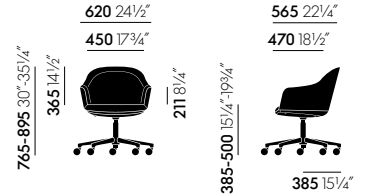

All measurements are pursuant to EN 1335-1:2000
More detailed information is found in the chapter 'Explanation of measurements'.

Backrest and seat: flexible upper backrest shell. Seat and backrest shell in fibreglass-reinforced polyamide. Seat and backrest upholstery in polyurethane foam. Armrests are integrated in the seat shell. With two seams along the sides of the backrest.

Five-star base: powder-coated (basic dark) or polished aluminium.

Softshell Chair

	Article no.	without VAT in SEK*	with VAT in SEK*
Five-star base	423 008 00		
Fabric F30		10.080,00	12.600,00
Fabric F40		10.240,00	12.800,00
Fabric F60		10.720,00	13.400,00
Fabric F80		11.280,00	14.100,00
Fabric F100		12.000,00	15.000,00
Fabric F120		12.560,00	15.700,00
Leather L20		17.680,00	22.100,00
Leather L50		21.440,00	26.800,00
Surcharges base			
aluminium base, powder-coated in basic dark	2	0,00	0,00
aluminium base, polished	3	456,00	570,00

Fabric F30	Fabric F40	Fabric F60	Fabric F80	Fabric F100	Fabric F120	Leather L20	Leather L50	Castors
Plano	Laser RE	Twill Volo	Dumet Linho Tress	Aura Reed	Credo	Leather	Leather Premium F	02 castors hard, braked for carpet 03 castors soft, braked for hard floor

Softshell Side Chair

Ronan & Erwan Bouroullec, 2017

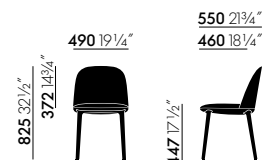

All measurements are pursuant to EN 1335-1:2000
More detailed information is found in the chapter 'Explanation of measurements'.

Backrest and seat: seat and backrest shell in fibreglass-reinforced polyamide, flexible upper backrest shell. Seat and backrest upholstery in polyurethane foam.

Four-legged base: polyamide in basic dark with glides.

Softshell Side Chair

	Article no.	without VAT in SEK*	with VAT in SEK*
Four-legged base	423 010 00		
Fabric F30		6.072,00	7.590,00
Fabric F40		6.240,00	7.800,00
Fabric F60		6.720,00	8.400,00
Fabric F80		7.192,00	8.990,00
Fabric F100		7.512,00	9.390,00
Fabric F120		8.240,00	10.300,00
Leather L20		13.840,00	17.300,00
Leather L50		16.960,00	21.200,00

Fabric F30	Fabric F40	Fabric F60	Fabric F80	Fabric F100	Fabric F120	Leather L20	Leather L50	Glides
Plano	Laser RE	Twill Volo	Dumet Linho Tress	Aura Reed	Credo	Leather	Leather Premium F	04 glides for carpet 05 felt glides for hard floor

Standard

Jean Prouvé, 1934/1950

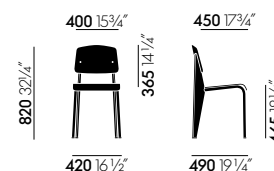

All measurements are pursuant to EN 1335-1:2000
More detailed information is found in the chapter 'Explanation of measurements'.

Seat and backrest: oak (natural or dark finish) or walnut (black-pigmented finish), USA.

Base: bent sheet steel and tubular steel, powder-coated finish (smooth).

Note: the steel frame in Métal Brut has a raw irregular surface protected by a transparent powder coating.

Standard

	Article no.	without VAT in SEK*	with VAT in SEK*
	210 435 00		
Seat and backrest in wood		7.752,00	9.690,00

Back and seat, veneer (Standard)

04 dark oak, with protective varnish
10 natural oak, with protective varnish
45 black pigmented walnut

Base

06 Japanese red powder-coated (smooth)
12 deep black powder-coated (smooth)
13 Prouvé Gris Vermeer powder-coated (smooth)
14 Prouvé Bleu Dynastie powder-coated (smooth)
18 Prouvé Blé Vert powder-coated (smooth)
41 Prouvé Bleu Marcoule powder-coated (smooth)
88 Prouvé Blanc Colombe (Ecrú) powder-coated (smooth)
94 Prouvé Métal Brut powder-coated (transparent, smooth)

Glides

04 glides for carpet
05 felt glides for hard floor

Standard SP

Jean Prouvé, 1934/1950

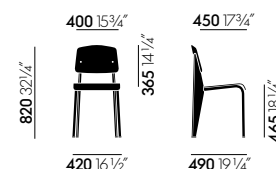

All measurements are pursuant to EN 1335-1:2000
More detailed information is found in the chapter 'Explanation of measurements'.

Seat and backrest: ASA plastic (fine-textured).

Base: bent sheet steel and tubular steel, powder-coated finish (smooth).

Note: the steel frame in Métal Brut has a raw irregular surface protected by a transparent powder coating.

Standard SP

	Article no.	without VAT in SEK*	with VAT in SEK*
	210 436 00		
Seat and backrest in plastic		5.352,00	6.690,00

Back and seat (Standard SP)

12 deep black
31 warm grey
35 basalt

Base

06 Japanese red powder-coated (smooth)
12 deep black powder-coated (smooth)
13 Prouvé Gris Vermeer powder-coated (smooth)
14 Prouvé Bleu Dynastie powder-coated (smooth)
18 Prouvé Blé Vert powder-coated (smooth)
41 Prouvé Bleu Marcoule powder-coated (smooth)
88 Prouvé Blanc Colombe (Ecrú) powder-coated (smooth)
94 Prouvé Métal Brut powder-coated (transparent, smooth)

Glides

04 glides for carpet
05 felt glides for hard floor

Stool-Tool

Konstantin Grcic, 2016

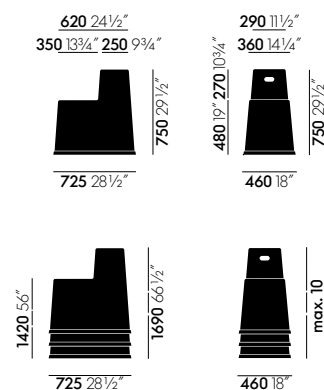

Stool-Tool

All measurements are pursuant to EN 1335-1:2000
 More detailed information is found in the chapter 'Explanation of measurements'.

Stool: polypropylene, 5.5 kg, up to 10 units can be stacked on the floor, incl. stacking protectors.

Glides: universal glides.

Applications: all colours are suited for outdoor use.

Note: special additives retard the fading of colours due to UV radiation. However, if Stool-Tool is exposed to sunlight for prolonged periods, the colour may change over time. For this reason, limited exposure to sunlight is advisable.

Stool-Tool

	Article no.	without VAT in SEK*	with VAT in SEK*
stackable	440 396 00	2.800,00	3.500,00

Stool

- 03 poppy red
- 24 light grey
- 76 industrial green

Tabouret Haut

Jean Prouvé, 1942

vitra.



All measurements are pursuant to EN 1335-1:2000
More detailed information is found in the chapter 'Explanation of measurements'.

Seat: solid oak, natural or dark stain, clear protective lacquer finish.

Base: solid oak legs, natural or dark stain, clear protective lacquer finish. Footrest: chrome-plated tubular steel, anti-skid surface.

Origin of wood: oak (Quercus robur) from Western Europe and/or Poland.

Tabouret Haut

	Article no.	without VAT in SEK*	with VAT in SEK*
	212 016 00		
natural oak, with protective varnish	1	8.080,00	10.100,00
dark oak, with protective varnish	2	8.080,00	10.100,00

Tip Ton

Edward Barber & Jay Osgerby, 2011



All measurements are pursuant to EN 1335-1:2000
More detailed information is found in the chapter 'Explanation of measurements'.

Backrest, seat, base: polypropylene.

Glides: polyethylene.

Stacking: Tip Ton can be stacked up to 4 chairs high on the floor, up to 11 on a stacking trolley. A stacking trolley is separately available.

Outdoor use: Tip Ton is suitable for outdoor use.

Note: special additives retard the fading of colours due to UV radiation. However, if the chair is exposed to sunlight for prolonged periods, the colour may change over time. We recommend limited exposure to sunlight.

Tip Ton

	Article no.	without VAT in SEK*	with VAT in SEK*
stackable	440 230 00		
Shell in all colours		3.000,00	3.750,00

Stacking trolley

	Article no.	without VAT in SEK*	with VAT in SEK*
Suitable for up to 11 chairs	440 235 00	14.720,00	18.400,00

Plastic chair

- 01 basic dark
- 04 white
- 23 ice grey
- 35 basalt
- 37 glacier blue
- 74 olive
- 76 industrial green
- 78 mango

Tip Ton RE

Edward Barber & Jay Osgerby, 2011/2020



All measurements are pursuant to EN 1335-1:2000
More detailed information is found in the chapter 'Explanation of measurements'.

Back, seat, base: recycled polypropylene, 100% recyclable.

Glides: recycled polyethylene.

Stacking: Tip Ton RE can be stacked up to 4 chairs high on the floor, up to 11 on a stacking trolley. A stacking trolley is separately available.

Outdoor use: Tip Ton RE is suitable for outdoor use.

Tip Ton RE

	Article no.	without VAT in SEK*	with VAT in SEK*
stacking	440 231 00		
recycled polypropylene		3.000,00	3.750,00

Recycled polypropylene

22 dark grey RE

Unix Chair

Antonio Citterio, 2010

vitra.



Four-star base



Five-star base

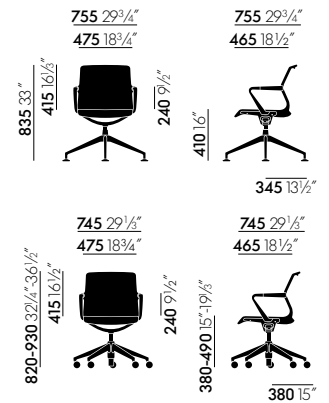

All measurements are pursuant to EN 1335-1:2000
More detailed information is found in the chapter 'Explanation of measurements'.

Seat frame and armrest sleeves: monochrome polypropylene in basic dark or soft grey.

Seat and back cover: Plano fabric or one of the 3D spacer fabrics Diamond Mesh (mesh look) or Silk Mesh (solid look). For Silk Mesh in the colour soft grey, the reverse side is in soft grey. For Silk Mesh in the colours nero and asphalt, the reverse side is in nero. For Silk Mesh in the colours olive green, smoke blue and dim grey, the reverse side matches the frame colour (soft grey or nero).

Five-star base: polished die-cast aluminium with double castors (Ø 60 mm). Swivel mechanism, height adjustable.

Four-star base: polished die-cast aluminium on glides. Swivel mechanism with vertical spring suspension for added comfort.

Unix Chair

	Article no.	without VAT in SEK*	with VAT in SEK*
Four-star base	431 205 00		
Silk Mesh		8.576,00	10.720,00
Diamond Mesh		8.576,00	10.720,00
Fabric F30		8.576,00	10.720,00

Unix Chair

	Article no.	without VAT in SEK*	with VAT in SEK*
Five-star base	431 206 00		
Silk Mesh		9.408,00	11.760,00
Diamond Mesh		9.408,00	11.760,00
Fabric F30		9.408,00	11.760,00

Fabric F30

Frame

Castors/Glides

Plano	30 basic dark 53 soft grey	02 castors hard, braked for carpet 03 castors soft, braked for hard floor 04 glides for carpet 05 felt glides for hard floor
-------	-------------------------------	---

Unix Chair

Antonio Citterio, 2010

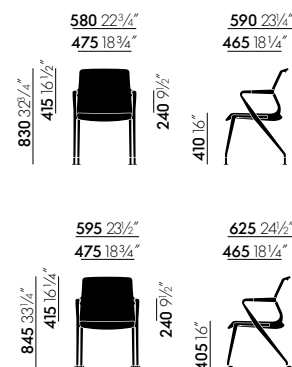

Unix Chair four-leg chair

Four-legged castor-based chair

All measurements are pursuant to EN 1335-1:2000
More detailed information is found in the chapter 'Explanation of measurements'.

Seat frame and armrest sleeves: monochrome polypropylene in basic dark or soft grey.

Seat and back cover: Plano fabric or one of the 3D spacer fabrics Diamond Mesh (mesh look) or Silk Mesh (solid look). For Silk Mesh in the colour soft grey, the reverse side is in soft grey. For Silk Mesh in the colours nero and asphalt, the reverse side is in nero. For Silk Mesh in the colours olive green, smoke blue and dim grey, the reverse side matches the frame colour (soft grey or nero).

Four-legged base: polished, die-cast aluminium equipped with glides or castors (Ø 60 mm).

Unix Chair	Article no.	without VAT in SEK*	with VAT in SEK*
Four-legged base	431 201 00		
Silk Mesh		7.288,00	9.110,00
Diamond Mesh		7.288,00	9.110,00
Fabric F30		7.288,00	9.110,00
Four-legged castor-based chair	431 202 00		
Silk Mesh		7.288,00	9.110,00
Diamond Mesh		7.288,00	9.110,00
Fabric F30		7.288,00	9.110,00

Fabric F30	Frame	Castors/Glides
Plano	30 basic dark 53 soft grey	02 castors hard, braked for carpet 03 castors soft, braked for hard floor 04 glides for carpet 05 felt glides for hard floor

Unix Chair

Antonio Citterio, 2010



Unix Chair Cantilever

All measurements are pursuant to EN 1335-1:2000
More detailed information is found in the chapter 'Explanation of measurements'.

Seat frame and armrest sleeves: monochrome polypropylene in basic dark or soft grey.

Seat and back cover: Plano fabric or one of the 3D spacer fabrics Diamond Mesh (mesh look) or Silk Mesh (solid look). For Silk Mesh in the colour soft grey, the reverse side is in soft grey. For Silk Mesh in the colours nero and asphalt, the reverse side is in nero. For Silk Mesh in the colours olive green, smoke blue and dim grey, the reverse side matches the frame colour (soft grey or nero).

Cantilever base: chrome-plated tubular steel on glides. Non-stacking and stacking versions (max. 4 chairs).

Unix Chair	Article no.	without VAT in SEK*	with VAT in SEK*
Cantilever tubular steel base	431 203 00		
Silk Mesh		7.072,00	8.840,00
Diamond Mesh		7.072,00	8.840,00
Fabric F30		7.072,00	8.840,00
Cantilever tubular steel base, stacking	431 204 00		
Silk Mesh		7.792,00	9.740,00
Diamond Mesh		7.792,00	9.740,00
Fabric F30		7.792,00	9.740,00

Fabric F30	Frame	Castors/Glides
Plano	30 basic dark 53 soft grey	02 castors hard, braked for carpet 03 castors soft, braked for hard floor 04 glides for carpet 05 felt glides for hard floor

Wiggle Side Chair & Wiggle Stool

Frank Gehry, 1972



Wiggle Side Chair

Structure: corrugated cardboard.

Edges: hardboard.

Wiggle Side Chair

	Article no.	without VAT in SEK*	with VAT in SEK*
natural	210 186 01	9.440,00	11.800,00



Wiggle Stool

Structure: corrugated cardboard.

Edges: hardboard.

Wiggle Stool

	Article no.	without VAT in SEK*	with VAT in SEK*
natural	210 226 01	5.032,00	6.290,00

Wire Chair DKR

Charles & Ray Eames, 1951



DKR



DKR-2



DKR-5

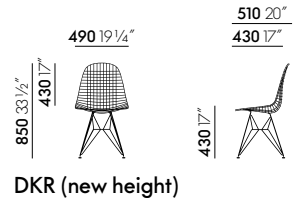

DKR (new height)

All measurements are pursuant to EN 1335-1:2000
More detailed information is found in the chapter 'Explanation of measurements'.

Upholstery: unupholstered, with seat cushion or with seat and back pad. Seat and back pads can be removed and reattached; available in Hopsak fabric or leather. For the back pad in leather, the rear is always covered in Plano fabric, except for the version in leather snow, which is used on both the front and back.

DKR: Dining Height K-Wire Shell R-Wire Base

Seat shell: bent and welded steel wire, chrome-plated or powder-coated. The powder-coated version is suitable for outdoor use.

Base: four-legged base with cross struts, surface finish matched to seat shell. Fitted with plastic glides for carpet; felt glides for hard floors optionally available.

DKR (new height)

	Article no.	without VAT in SEK*	with VAT in SEK*
wire base with cross struts, non-stacking	412 150 00		
without cover			
Frame chrome-plated or powder-coated	1	4.360,00	5.450,00

DKR-2 (new height)

	Article no.	without VAT in SEK*	with VAT in SEK*
wire base with cross struts, non-stacking	412 152 00		
with seat and back pads			
Fabric F60		6.016,00	7.520,00
Fabric F200		7.976,00	9.970,00
Leather L20		6.696,00	8.370,00
Leather L50		7.376,00	9.220,00

DKR-5 (new height)

	Article no.	without VAT in SEK*	with VAT in SEK*
wire base with cross struts, non-stacking	412 151 00		
with seat pad			
Fabric F60		5.360,00	6.700,00
Leather L20		5.800,00	7.250,00
Leather L50		6.472,00	8.090,00

Fabric F60	Fabric F200	Leather L20	Leather L50	Seat and base	Glides
. Hopsak	. Checker	. Leather	. Leather Premium F	01 chrome 04 white powder-coated (smooth) 30 basic dark powder-coated (smooth)	04 basic dark for carpet 05 felt basic dark for hard floor 14 white for carpet 15 felt white for hard floor

Wire Chair DKR

Charles & Ray Eames, 1951

vitra.



DKR Colours

Wire base with cross struts, powder-coated,
non-stacking, glides in black

without cover

	Article no.	without VAT in SEK*	with VAT in SEK*
Eames Sea Foam Green 31	412 150 01	4.360,00	5.450,00
citron 92	412 150 02	4.360,00	5.450,00
sky blue 93	412 150 03	4.360,00	5.450,00
dark green 24	412 150 04	4.360,00	5.450,00

Wire Chair DKW

Charles & Ray Eames, 1951



DKW



DKW-2



DKW-5



DKW (new height)

All measurements are pursuant to EN 1335-1:2000
More detailed information is found in the chapter 'Explanation of measurements'.

Upholstery: unupholstered, with seat cushion or with seat and back pad. Seat and back pads can be removed and reattached; available in Hopsak fabric or leather. For the back pad in leather, the rear is always covered in Plano fabric, except for the version in leather snow, which is used on both the front and back.

DKW: Dining Height K-Wire Shell Wood-Base

Seat shell: bent and welded steel wire, powder-coated in basic dark.

Base: solid maple with stained finish, steel rod cross struts. Fitted with plastic glides for carpet; felt glides for hard floors optionally available.

Origin of wood: maple (*Acer platanoides*) from Western Europe and/or Poland.

DKW (new height)

	Article no.	without VAT in SEK*	with VAT in SEK*
wood base with cross struts, non-stacking	412 160 00		
without cover			
Base maple		5.832,00	7.290,00

DKW-2 (new height)

	Article no.	without VAT in SEK*	with VAT in SEK*
wood base with cross struts, non-stacking	412 162 00		
with seat and back pads			
Fabric F60		7.488,00	9.360,00
Fabric F200		9.448,00	11.810,00
Leather L20		8.168,00	10.210,00
Leather L50		8.848,00	11.060,00

DKW-5 (new height)

	Article no.	without VAT in SEK*	with VAT in SEK*
wood base with cross struts, non-stacking	412 161 00		
with seat pad			
Fabric F60		6.832,00	8.540,00
Leather L20		7.272,00	9.090,00
Leather L50		7.944,00	9.930,00

Fabric F60	Fabric F200	Leather L20	Leather L50	Seat	Base	Glides
. Hopsak	. Checker	. Leather	. Leather Premium F	01 chrome 04 white powder-coated (smooth) 30 basic dark powder-coated (smooth)	02 golden maple 30 black maple 95 dark maple	04 basic dark for carpet 05 felt basic dark for hard floor 14 white for carpet 15 felt white for hard floor

Wire Chair DKX

Charles & Ray Eames, 1951



DKX



DKX-2



DKX-5



DKX (new height)

All measurements are pursuant to EN 1335-1:2000
More detailed information is found in the chapter 'Explanation of measurements'.

Upholstery: unupholstered, with seat cushion or with seat and back pad. Seat and back pads can be removed and reattached; available in Hopsak fabric or leather. For the back pad in leather, the rear is always covered in Plano fabric, except for the version in leather snow, which is used on both the front and back.

DKX: Dining Height K-Wire Shell X-Base

Seat shell: bent and welded steel wire, chrome-plated or powder-coated. The powder-coated version is suitable for outdoor use.

Base: four-legged tubular steel base, surface finish matched to seat shell. Fitted with plastic glides for carpet; felt glides for hard floors optionally available.

DKX (new height)

	Article no.	without VAT in SEK*	with VAT in SEK*
four-legged tubular steel base, non-stacking	412 155 00		
without cover			
Frame chrome-plated or powder-coated		4.008,00	5.010,00

DKX-2 (new height)

	Article no.	without VAT in SEK*	with VAT in SEK*
four-legged tubular steel base, non-stacking	412 157 00		
with seat and back pads			
Fabric F60		5.664,00	7.080,00
Fabric F200		7.624,00	9.530,00
Leather L20		6.344,00	7.930,00
Leather L50		7.024,00	8.780,00

DKX-5 (new height)

	Article no.	without VAT in SEK*	with VAT in SEK*
four-legged tubular steel base, non-stacking	412 156 00		
with seat pad			
Fabric F60		5.008,00	6.260,00
Leather L20		5.448,00	6.810,00
Leather L50		6.120,00	7.650,00

Fabric F60	Fabric F200	Leather L20	Leather L50	Seat and base	Glides
. Hopsak	. Checker	. Leather	. Leather Premium F	01 chrome 04 white powder-coated (smooth) 30 basic dark powder-coated (smooth)	04 basic dark for carpet 05 felt basic dark for hard floor 14 white for carpet 15 felt white for hard floor

Wire Chair LKR

Charles & Ray Eames, 1951



LKR



LKR-2



LKR-5

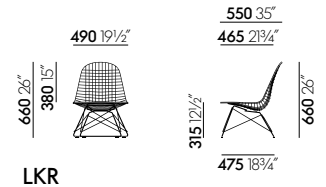

All measurements are pursuant to EN 1335-1:2000
More detailed information is found in the chapter 'Explanation of measurements'.

Upholstery: unupholstered, with seat cushion or with seat and back pad. Seat and back pads can be removed and reattached; available in Hopsak fabric or leather. For the back pad in leather, the rear is always covered in Plano fabric, except for the version in leather snow, which is used on both the front and back.

LKR: Lounge Height K-Wire Shell, Rod base.

Seat shell: bent and welded steel wire, chrome-plated or powder-coated. The powder-coated version is suitable for outdoor use.

Base: wire base with cross struts, chrome-plated or powder-coated finish. Surface finish matched to seat shell. The powder-coated version is suitable for outdoor use. Seat height 260 mm.

LKR	Article no.	without VAT in SEK*	with VAT in SEK*
wire base with cross struts, non-stacking		412 254 00	
without cover			
Base chrome		5.336,00	6.670,00

LKR-2	Article no.	without VAT in SEK*	with VAT in SEK*
wire base with cross struts, non-stacking		412 256 00	
with seat and back cushions			
Fabric F60		6.992,00	8.740,00
Fabric F200		8.952,00	11.190,00
Leather L20		7.672,00	9.590,00
Leather L50		8.352,00	10.440,00

LKR-5	Article no.	without VAT in SEK*	with VAT in SEK*
wire base with cross struts, non-stacking		412 255 00	
with seat cushion			
Fabric F60		6.336,00	7.920,00
Leather L20		6.776,00	8.470,00
Leather L50		7.448,00	9.310,00

Fabric F60	Leather L20	Leather L50	Seat and base	Glides
. Hopsak	. Leather	. Leather Premium F	01 chrome 04 white powder-coated (smooth) 30 basic dark powder-coated (smooth)	04 basic dark for carpet 05 felt basic dark for hard floor 14 white for carpet 15 felt white for hard floor

Wire Chair LKR

Charles & Ray Eames, 1951

vitra.



LKR Colours

Wire base with cross struts, powder-coated,
non-stacking, glides in black

without cover

	Article no.	without VAT in SEK*	with VAT in SEK*
Eames Sea Foam Green 31	412 254 01	5.336,00	6.670,00
citron 92	412 254 02	5.336,00	6.670,00
sky blue 93	412 254 03	5.336,00	6.670,00
dark green 24	412 254 04	5.336,00	6.670,00

Tables



Belleville Table
R & E Bouroullec
162



Bistro Table
R & E Bouroullec
164



Eames Contract Tables
Charles & Ray Eames
168



Eames Segmented Tables Dining
Charles & Ray Eames
170



EM Table
Jean Prouvé
172



Dining Table
Isamu Noguchi
176



Guéridon
Jean Prouvé
177



Plate Dining Table
Jasper Morrison
178



Super Fold Table
Jasper Morrison
180



Super Fold Table
Jasper Morrison
182



Table S.A.M. Bois
Jean Prouvé
184



Trapèze
Jean Prouvé
185

Office and conference chairs (swivel)

Chairs

Tables

Desks

Public waiting areas

Lounge chairs and armchairs

Sofas

Coffee and side tables

Stools and benches

Storage and partition elements

Accessories

Living, dining, decorative objects, home office,
clocks, lighting, publications

Quick Ship programme

General terms, conditions
and information

Belleville Table

Ronan & Erwan Bouroullec, 2015



Ø 796 31¼"



Ø 796 31¼"

Round table, Ø 796 mm

1060 41¾"

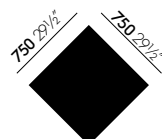
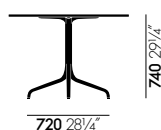

Square table, 750 x 750 mm

1600 63"



Rectangular table, 1600 x 750 mm

Table top: oak veneer in natural or dark oak (20 mm); melamine faced in white with smooth straight plastic edge (19 mm); or solid core material with black edge (12 mm) in the colours white or black. Solid core table top in black with anti-fingerprint coating.

Base: powder-coated with finely textured finish in deep black (RAL 9005). The height of the base including screw-in glides is 720 mm; the glides can be adjusted (max. extension 10 mm) for levelling on uneven floors.

Applications: table with top in solid core material and powder-coated base is suited for outdoor use. We recommend limited exposure to sunlight. The powder-coated bases are pre-galvanised.

Belleville Table

Ronan & Erwan Bouroullec, 2015

vitra.

Round table, indoor, Ø 796 mm

	Article no.	without VAT in SEK*	with VAT in SEK*
	443 024 01		
Base deep black, melamine white	1203	6.552,00	8.190,00
Base deep black, veneer dark oak	1204	11.200,00	14.000,00
Base deep black, veneer light oak	1217	11.200,00	14.000,00

Round table, outdoor, Ø 796 mm

	Article no.	without VAT in SEK*	with VAT in SEK*
	443 025 01		
Base deep black, solid core material white	1201	8.160,00	10.200,00
Base deep black, solid core material black	1230	8.160,00	10.200,00

Square table, indoor, 750 x 750 mm

	Article no.	without VAT in SEK*	with VAT in SEK*
	443 026 01		
Base deep black, melamine white	1203	6.552,00	8.190,00
Base deep black, veneer dark oak	1204	11.200,00	14.000,00
Base deep black, veneer light oak	1217	11.200,00	14.000,00

Square table, outdoor, 750 x 750 mm

	Article no.	without VAT in SEK*	with VAT in SEK*
	443 027 01		
Base deep black, solid core material white	1201	8.160,00	10.200,00
Base deep black, solid core material black	1230	8.160,00	10.200,00

Rectangular table, indoor, 1600 x 750 mm

	Article no.	without VAT in SEK*	with VAT in SEK*
	443 028 01		
Base deep black, melamine white	1203	15.360,00	19.200,00
Base deep black, veneer dark oak	1204	20.960,00	26.200,00
Base deep black, veneer light oak	1217	20.960,00	26.200,00

Rectangular table, outdoor, 1600 x 750 mm

	Article no.	without VAT in SEK*	with VAT in SEK*
	443 029 01		
Base deep black, solid core material white	1201	16.640,00	20.800,00
Base deep black, solid core material black	1230	16.640,00	20.800,00

Bistro Stand-up Table

Ronan & Erwan Bouroullec, 2010



Ø 796 Ø 31¼"



Ø 796 Ø 31¼"



1100 43¼"

Ø 642 Ø 25¼"



Ø 642 Ø 25¼"



1100 43¼"

Table tops available in three materials: melamine faced, white surface, smooth straight plastic edge (19 mm); light or dark oak veneer (Europe) (19 mm); solid core laminate in the colours white or black with black edge (12 mm). The solid core table top in black has an additional anti-fingerprint coating.

Base: powder-coated in basic dark (RAL 9004). The height of the base including screw-in glides is 1080 mm; the glides can be adjusted (max. extension 10 mm) for levelling on uneven floors.

Applications: table with top in solid core laminate is also suited for outdoor use. We recommend limiting the table's exposure to sunlight. Pre-galvanised base.

Round table, indoor, Ø 796 mm

	Article no.	without VAT in SEK*	with VAT in SEK*
443 010 00			
basic dark, melamine white	3001	6.792,00	8.490,00
basic dark, compact laminate white	3004	8.400,00	10.500,00
basic dark, compact laminate black	3005	9.360,00	11.700,00
basic dark, light oak veneer	3002	12.240,00	15.300,00
basic dark, dark oak veneer	3003	12.240,00	15.300,00
package of 10			
443 010 01			
basic dark, melamine white	3001	67.920,00	84.900,00
basic dark, compact laminate white	3004	84.000,00	105.000,00
basic dark, compact laminate black	3005	93.600,00	117.000,00
basic dark, light oak veneer	3002	122.400,00	153.000,00
basic dark, dark oak veneer	3003	122.400,00	153.000,00

Bistro Stand-up Table

Ronan & Erwan Bouroullec, 2010

vitra.

Round table, outdoor, Ø 796 mm	Article no.	without VAT in SEK*	with VAT in SEK*
	443 011 00		
basic dark, compact laminate white	3004	10.080,00	12.600,00
basic dark, compact laminate black	3005	10.960,00	13.700,00
package of 10	443 011 01		
basic dark, compact laminate white	3004	100.800,00	126.000,00
basic dark, compact laminate black	3005	109.600,00	137.000,00

Round table, indoor, Ø 642 mm	Article no.	without VAT in SEK*	with VAT in SEK*
	443 012 00		
basic dark, melamine white	3001	6.680,00	8.350,00
basic dark, compact laminate white	3004	8.320,00	10.400,00
basic dark, compact laminate black	3005	9.120,00	11.400,00
basic dark, light oak veneer	3002	12.160,00	15.200,00
basic dark, dark oak veneer	3003	12.160,00	15.200,00
package of 10	443 012 01		
basic dark, melamine white	3001	66.800,00	83.500,00
basic dark, compact laminate white	3004	83.200,00	104.000,00
basic dark, compact laminate black	3005	91.200,00	114.000,00
basic dark, light oak veneer	3002	121.600,00	152.000,00
basic dark, dark oak veneer	3003	121.600,00	152.000,00

Round table, outdoor, Ø 642 mm	Article no.	without VAT in SEK*	with VAT in SEK*
	443 013 00		
basic dark, compact laminate white	3004	9.840,00	12.300,00
basic dark, compact laminate black	3005	10.640,00	13.300,00
package of 10	443 013 01		
basic dark, compact laminate white	3004	98.400,00	123.000,00
basic dark, compact laminate black	3005	106.400,00	133.000,00

Bistro Table

Ronan & Erwan Bouroullec, 2009/2010



Ø796 Ø31¼"



Ø796 Ø31¼"



740 29¼"

640 25¼"



796 31¼"

640 25¼"



740 31¼"

Table tops available in three materials: melamine faced, white surface, smooth straight plastic edge (19 mm); light or dark oak veneer (Europe) (19 mm); solid core laminate in the colours white or black with black edge (12 mm). The solid core table top in black has an additional anti-fingerprint coating.

Base: powder-coated in basic dark (RAL 9004). The height of the base including screw-in glides is 715 mm; the glides can be adjusted (max. extension 10 mm) for levelling on uneven floors.

Applications: table with top in solid core laminate is also suited for outdoor use. We recommend limiting the table's exposure to sunlight. Pre-galvanised base.

Round table, indoor, Ø 796 mm

	Article no.	without VAT in SEK*	with VAT in SEK*
443 008 00			
basic dark, melamine white	3001	6.600,00	8.250,00
basic dark, compact laminate white	3004	8.320,00	10.400,00
basic dark, compact laminate black	3005	9.200,00	11.500,00
basic dark, light oak veneer	3002	12.160,00	15.200,00
basic dark, dark oak veneer	3003	12.160,00	15.200,00
package of 10			
443 008 01			
basic dark, melamine white	3001	66.000,00	82.500,00
basic dark, compact laminate white	3004	83.200,00	104.000,00
basic dark, compact laminate black	3005	92.000,00	115.000,00
basic dark, light oak veneer	3002	121.600,00	152.000,00
basic dark, dark oak veneer	3003	121.600,00	152.000,00

Bistro Table

Ronan & Erwan Bouroullec, 2009/2010

vitra.

Round table, outdoor, Ø 796 mm

	Article no.	without VAT in SEK*	with VAT in SEK*
	443 009 00		
basic dark, compact laminate white	3004	9.840,00	12.300,00
basic dark, compact laminate black	3005	10.800,00	13.500,00
package of 10	443 009 01		
basic dark, compact laminate white	3004	98.400,00	123.000,00
basic dark, compact laminate black	3005	108.000,00	135.000,00

Rectangular table, indoor, 640 x 796 mm

	Article no.	without VAT in SEK*	with VAT in SEK*
	443 006 00		
basic dark, melamine white	3001	6.680,00	8.350,00
basic dark, compact laminate white	3004	7.832,00	9.790,00
basic dark, compact laminate black	3005	8.240,00	10.300,00
basic dark, light oak veneer	3002	11.760,00	14.700,00
basic dark, dark oak veneer	3003	11.760,00	14.700,00
package of 10	443 006 01		
basic dark, melamine white	3001	66.800,00	83.500,00
basic dark, compact laminate white	3004	78.320,00	97.900,00
basic dark, compact laminate black	3005	82.400,00	103.000,00
basic dark, light oak veneer	3002	117.600,00	147.000,00
basic dark, dark oak veneer	3003	117.600,00	147.000,00

Rectangular table, outdoor, 640 x 796 mm

	Article no.	without VAT in SEK*	with VAT in SEK*
	443 007 00		
basic dark, compact laminate white	3004	9.360,00	11.700,00
basic dark, compact laminate black	3005	9.760,00	12.200,00
package of 10	443 007 01		
basic dark, compact laminate white	3004	93.600,00	117.000,00
basic dark, compact laminate black	3005	97.600,00	122.000,00

Eames Contract Tables

Charles & Ray Eames, 1968

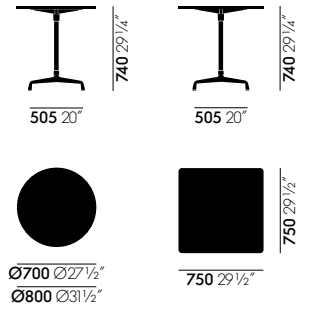

Table tops: available in four materials: melamine faced white surface (25 mm) with smooth straight plastic edge in white; light or dark oak veneer (Europe) (25 mm) with straight veneer edge; solid core laminate in white (12 mm) with black edge; HPL (25 mm) with black edge.

Base: stable pedestal base, four-star legs in die-cast aluminium. Available in four versions: base polished or chrome-plated with column in basic dark (RAL 9004), all chrome or all powder-coated (textured finish) in deep black (RAL 9005) or white (RAL 9010). The height of the base including screw-in glides is 71 cm; the glides can be adjusted (max. extension 10 mm) for levelling on uneven floors.

Applications: the powder-coated base can be paired with a solid core table top for outdoor use.

Eames Contract Tables

Charles & Ray Eames, 1968

Round table, Ø 70

	Article no.	without VAT in SEK*	with VAT in SEK*
443 039 01			
Table top			
melamine white	03	6.672,00	8.340,00
compact laminate white, suitable for outdoor use	01	7.744,00	9.680,00
HPL white, plastic edge black	12	8.592,00	10.740,00
light oak veneer	17	10.160,00	12.700,00
dark oak veneer	04	10.160,00	12.700,00
Universal base			
base polished, column powder-coated in basic dark	40	0,00	0,00
base chrome, column powder-coated in basic dark	10	472,00	590,00
base and column powder-coated in deep black, suitable for outdoor use	51	472,00	590,00
base and column powder-coated in white, suitable for outdoor use	61	472,00	590,00
base and column chrome	20	832,00	1.040,00

Round table, Ø 80

	Article no.	without VAT in SEK*	with VAT in SEK*
443 040 01			
Table top			
melamine white	03	6.904,00	8.630,00
compact laminate white, suitable for outdoor use	01	8.200,00	10.250,00
HPL white, plastic edge black	12	9.176,00	11.470,00
light oak veneer	17	11.344,00	14.180,00
dark oak veneer	04	11.344,00	14.180,00
Universal base			
base polished, column powder-coated in basic dark	40	0,00	0,00
base chrome, column powder-coated in basic dark	10	472,00	590,00
base and column powder-coated in deep black, suitable for outdoor use	51	472,00	590,00
base and column powder-coated in white, suitable for outdoor use	61	472,00	590,00
base and column chrome	20	832,00	1.040,00

Square table, 75 x 75

	Article no.	without VAT in SEK*	with VAT in SEK*
443 042 01			
Table top			
melamine white	03	6.904,00	8.630,00
compact laminate white, suitable for outdoor use	01	8.200,00	10.250,00
HPL white, plastic edge black	12	9.176,00	11.470,00
light oak veneer	17	11.344,00	14.180,00
dark oak veneer	04	11.344,00	14.180,00
Universal base			
base polished, column powder-coated in basic dark	40	0,00	0,00
base chrome, column powder-coated in basic dark	10	472,00	590,00
base and column powder-coated in deep black, suitable for outdoor use	51	472,00	590,00
base and column powder-coated in white, suitable for outdoor use	61	472,00	590,00
base and column chrome	20	832,00	1.040,00

Eames Segmented Tables Dining

Charles & Ray Eames, 1964

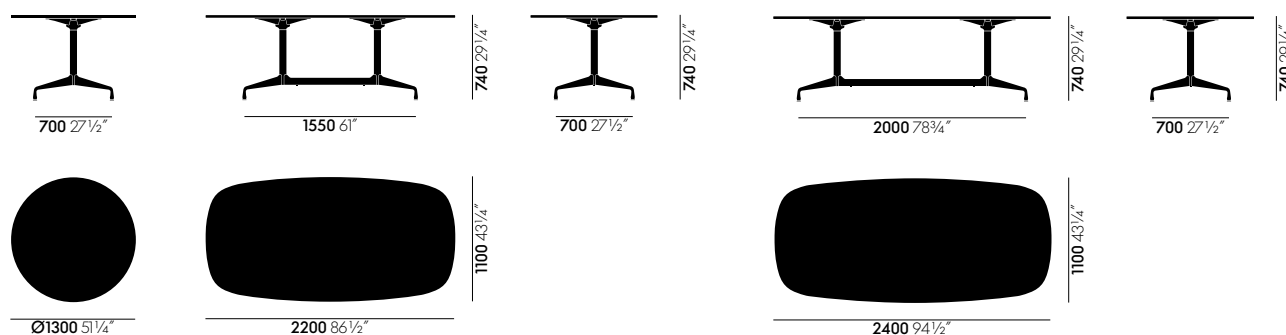

Table top: 25 mm thick, solid wood in natural oak with oiled finish, dark stained oak with protective natural lacquer finish, or American walnut with oiled finish; or HPL (high-pressure laminate) surface with black edges.

Base: components for segmented base include legs, spreader connectors, spreaders, columns and spiders. Legs polished or chrome-plated with column in basic dark (RAL 9004), all chrome or all powder-coated (textured finish) in deep black (RAL 9005).

Origin of wood: oak (*Quercus robur*) from Western Europe and/or Poland; American walnut (*Juglans nigra*) from the USA.

Eames Segmented Tables Dining

Charles & Ray Eames, 1964

vitra.

Round table Ø 130

	Article no.	without VAT in SEK*	with VAT in SEK*
H 740 x Ø 1300 mm	403 115 01		
Table top			
HPL white, plastic edge black	M1S12	16.880,00	21.100,00
solid natural oak, oiled finish	G1S70	36.320,00	45.400,00
dark solid oak, with protective varnish	G1S04	44.080,00	55.100,00
solid American walnut, oiled finish	G1S75	50.640,00	63.300,00
Base			
legs polished, column basic dark	OF40	0,00	0,00
legs and column deep black	OF51	0,00	0,00
legs chrome, column basic dark	OF10	1.184,00	1.480,00
legs and column chrome	OF20	2.232,00	2.790,00
	Basic price:	16.880,00	21.100,00

Boat-shaped table 220 x 110

	Article no.	without VAT in SEK*	with VAT in SEK*
H 740 x W 2200 x D 1100 mm	403 116 01		
Table top			
HPL white, plastic edge black	M1S12	28.640,00	35.800,00
solid natural oak, oiled finish	G1S70	53.600,00	67.000,00
dark solid oak, with protective varnish	G1S04	64.720,00	80.900,00
solid American walnut, oiled finish	G1S75	74.560,00	93.200,00
Base			
legs polished, column basic dark	OF40	0,00	0,00
legs and column deep black	OF51	0,00	0,00
legs chrome, column basic dark	OF10	1.640,00	2.050,00
base and column chrome	OF20	4.392,00	5.490,00
	Basic price:	28.640,00	35.800,00

Boat-shaped table 240 x 110

	Article no.	without VAT in SEK*	with VAT in SEK*
H 740 x W 2400 x D 1100 mm	403 117 01		
Table top			
HPL white, plastic edge black	M1S12	36.880,00	46.100,00
solid natural oak, oiled finish	G1S70	68.720,00	85.900,00
dark solid oak, with protective varnish	G1S04	83.120,00	103.900,00
solid American walnut, oiled finish	G1S75	95.520,00	119.400,00
Base			
legs polished, column basic dark	OF40	0,00	0,00
legs and column deep black	OF51	0,00	0,00
legs chrome, column basic dark	OF10	1.640,00	2.050,00
base and column chrome	OF20	4.720,00	5.900,00
	Basic price:	36.880,00	46.100,00

EM Table

Jean Prouvé, 1950



EM Table



EM Table (HPL)

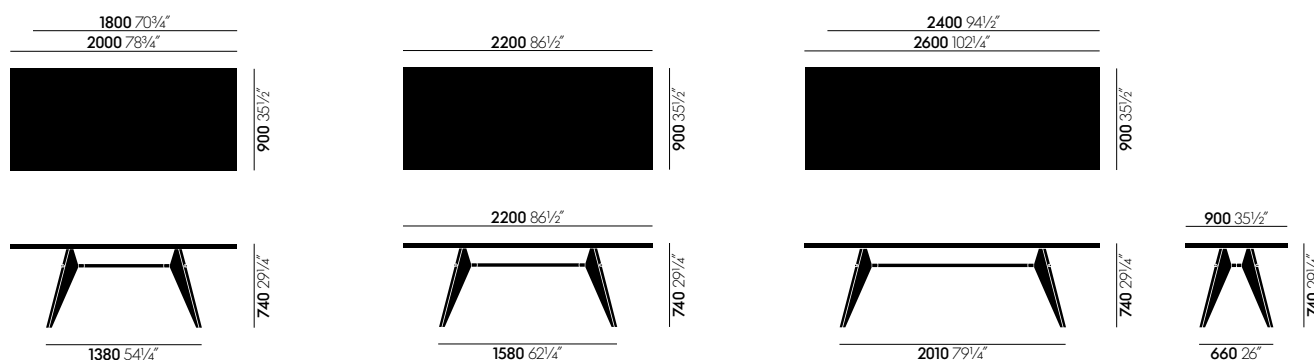

Solid wood table top: 34 mm thick; natural oak with oiled finish, dark stained oak with protective natural lacquer finish, or American walnut with oiled finish.

Base: bent sheet steel and tubular steel, powder-coated.

Note: the steel frame in Métal Brut has a raw irregular surface protected by a transparent powder coating.

Origin of wood: oak (*Quercus robur*) from Western Europe and/or Poland; American walnut (*Juglans nigra*) from the USA.

Veneer table top: 39 mm thick; natural or dark stained oak (Europe), protective natural lacquer finish.

Base: bent sheet steel and tubular steel, powder-coated.

HPL table top: 40 mm thick, high pressure laminate surface and edges.

Base: bent sheet steel and tubular steel, powder-coated.

EM Table

Jean Prouvé, 1950

EM Table (wood)	Article no.	without VAT in SEK*	with VAT in SEK*
H 740 x W 900 x L 1800 mm	212 033 00		
natural oak veneer with protective varnish	03	34.160,00	42.700,00
dark oak veneer with protective varnish	04	34.160,00	42.700,00
natural solid oak, oiled	70	40.080,00	50.100,00
dark solid oak, with protective varnish	44	48.640,00	60.800,00
solid American walnut, oiled	75	55.520,00	69.400,00
H 740 x W 900 x L 2000 mm	212 034 00		
natural oak, veneer with protective varnish	03	37.200,00	46.500,00
dark oak, veneer with protective varnish	04	37.200,00	46.500,00
solid oak, natural, oiled	70	43.600,00	54.500,00
dark solid oak, with protective varnish	44	53.120,00	66.400,00
solid American walnut, oiled	75	60.160,00	75.200,00
H 740 x W 900 x L 2200 mm	212 035 00		
natural oak veneer with protective varnish	03	38.960,00	48.700,00
dark oak veneer with protective varnish	04	38.960,00	48.700,00
natural solid oak, oiled	70	45.760,00	57.200,00
dark solid oak, with protective varnish	44	55.600,00	69.500,00
solid American walnut, oiled	75	63.360,00	79.200,00
H 740 x W 900 x L 2400 mm	212 036 00		
natural oak, veneer with protective varnish	03	42.640,00	53.300,00
dark oak, veneer with protective varnish	04	42.640,00	53.300,00
solid oak, natural, oiled	70	50.160,00	62.700,00
dark solid oak, with protective varnish	44	60.800,00	76.000,00
solid American walnut, oiled	75	69.680,00	87.100,00
H 740 x W 900 x L 2600 mm	212 037 00		
natural oak veneer with protective varnish	03	46.400,00	58.000,00
dark oak veneer with protective varnish	04	46.400,00	58.000,00
natural solid oak, oiled	70	54.640,00	68.300,00
dark solid oak, with protective varnish	44	66.160,00	82.700,00
solid American walnut, oiled	75	76.000,00	95.000,00
Surcharges base			
Colour group 1		0,00	0,00
Colour group 2		1.352,00	1.690,00

Base frame Colour group 1

06 Japanese red powder-coated (smooth)
12 deep black powder-coated (smooth)
88 Prouvé Blanc Colombe (Ecrú) powder-coated (smooth)

Base frame Colour group 2

13 Prouvé Gris Vermeer powder-coated (smooth)
14 Prouvé Bleu Dynastie powder-coated (smooth)
18 Prouvé Blé Vert powder-coated (smooth)
41 Prouvé Bleu Marcoule powder-coated (smooth)
94 Prouvé Métal Brut powder-coated (transparent, smooth)

EM Table

Jean Prouvé, 1950

vitra.

EM Table (HPL)	Article no.	without VAT in SEK*	with VAT in SEK*
H 740 x W 900 x L 1800 mm	212 038 00		
HPL ivory	49	26.800,00	33.500,00
HPL asphalt	67	26.800,00	33.500,00
H 740 x W 900 x L 2000 mm	212 039 00		
HPL ivory	49	27.920,00	34.900,00
HPL asphalt	67	27.920,00	34.900,00
H 740 x W 900 x L 2200 mm	212 040 00		
HPL ivory	49	30.720,00	38.400,00
HPL asphalt	67	30.720,00	38.400,00
H 740 x W 900 x L 2400 mm	212 041 00		
HPL ivory	49	33.440,00	41.800,00
HPL asphalt	67	33.440,00	41.800,00
H 740 x W 900 x L 2600 mm	212 042 00		
HPL ivory	49	36.640,00	45.800,00
HPL asphalt	67	36.640,00	45.800,00
Surcharges base			
Colour group 1		0,00	0,00
Colour group 2		1.352,00	1.690,00

Base frame Colour group 1

06 Japanese red powder-coated (smooth)
12 deep black powder-coated (smooth)
88 Prouvé Blanc Colombe (Ecrû) powder-coated (smooth)

Base frame Colour group 2

13 Prouvé Gris Vermeer powder-coated (smooth)
14 Prouvé Bleu Dynastie powder-coated (smooth)
18 Prouvé Blé Vert powder-coated (smooth)
41 Prouvé Bleu Marcoule powder-coated (smooth)
94 Prouvé Métal Brut powder-coated (transparent, smooth)

Dining Table

Isamu Noguchi, 1957

vitra.

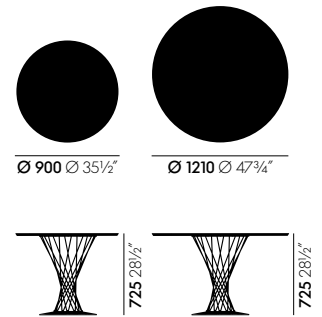

Table top: plywood with hard laminate surface, black-stained edge.

Base: cast iron with black lacquer finish, chrome-plated steel wire.

Range of use: recommended for residential use only.

Dining Table

		Article no.	without VAT in SEK*	with VAT in SEK*
Ø 900 mm	white table top	201 328 02	39.600,00	49.500,00
Ø 1210 mm	white table top	201 328 01	41.600,00	52.000,00

Guéridon

Jean Prouvé, 1949

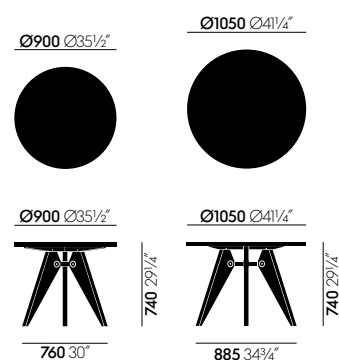

Table top: solid wood in natural oak with oiled finish, dark stained oak with protective natural lacquer finish, or American walnut with oiled finish.

Base: legs matched to table top, solid wood in natural oak with oiled finish, dark stained oak with protective natural lacquer finish, or American walnut with oiled finish; tubular steel crossbar with powder-coated finish (smooth)

Origin of wood: oak (*Quercus robur*) from Western Europe and/or Poland; American walnut (*Juglans nigra*) from the USA.

Guéridon	Article no.	without VAT in SEK*	with VAT in SEK*
Ø 900 x H 740 mm	212 024 00		
solid natural oak, oiled	70	21.040,00	26.300,00
solid dark oak, with protective varnish	04	24.640,00	30.800,00
solid American walnut, oiled	75	29.520,00	36.900,00
Ø 1050 x H 740 mm	212 025 00		
solid natural oak, oiled	70	22.560,00	28.200,00
solid dark oak, with protective varnish	04	26.560,00	33.200,00
solid American walnut, oiled	75	31.760,00	39.700,00

Plate Dining Table

Jasper Morrison, 2018

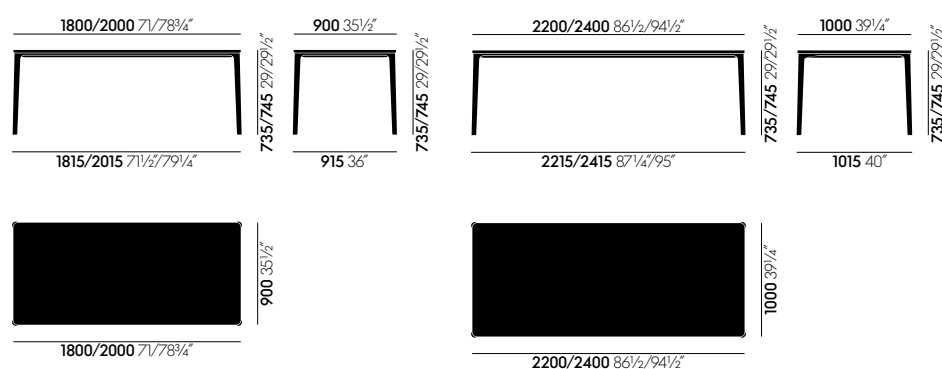

MDF table tops: 25 mm thick, powder-coated finish.

Solid wood table tops: 22 mm thick, oiled; natural oak or dark oak with protective natural lacquer finish.

Glass table top: 12 mm thick, float glass with satin finish, lacquered underside, ground edge.

Marble table top: 15 mm thick, Carrara marble, brushed and waxed.

Base: legs in die-cast aluminium, extruded crossbars, powder-coated.

Origin of wood: oak (*Quercus robur*) from Germany and France.

Plate Dining Table

Jasper Morrison, 2018

Plate Dining Table	Article no.	without VAT in SEK*	with VAT in SEK*
H 735/745 x W 900 x L 1800 mm	212 053 00		
MDF, powder-coated in white	04	25.360,00	31.700,00
MDF, powder-coated in basic dark	30	25.360,00	31.700,00
satin-finished glass, underside lacquered in light grey	83	31.440,00	39.300,00
satin-finished glass, underside lacquered in white	82	31.440,00	39.300,00
solid natural oak, oiled finish	70	36.560,00	45.700,00
solid dark oak, with protective varnish	44	44.320,00	55.400,00
Carrara marble	50	72.800,00	91.000,00
H 735/745 x W 900 x L 2000 mm	212 054 00		
MDF, powder-coated in white	04	27.520,00	34.400,00
MDF, powder-coated in basic dark	30	27.520,00	34.400,00
satin-finished glass, underside lacquered in light grey	83	34.400,00	43.000,00
satin-finished glass, underside lacquered in white	82	34.400,00	43.000,00
solid natural oak, oiled finish	70	39.680,00	49.600,00
solid dark oak, with protective varnish	44	48.000,00	60.000,00
Carrara marble	50	78.880,00	98.600,00
H 735/745 x W 1000 x L 2200 mm	212 055 00		
MDF, powder-coated in white	04	29.120,00	36.400,00
MDF, powder-coated in basic dark	30	29.120,00	36.400,00
satin-finished glass, underside lacquered in light grey	83	36.160,00	45.200,00
satin-finished glass, underside lacquered in white	82	36.160,00	45.200,00
solid natural oak, oiled finish	70	41.680,00	52.100,00
solid dark oak, with protective varnish	44	50.560,00	63.200,00
Carrara marble	50	83.120,00	103.900,00
H 735/745 x W 1000 x L 2400 mm	212 056 00		
MDF, powder-coated in white	04	31.440,00	39.300,00
MDF, powder-coated in basic dark	30	31.440,00	39.300,00
satin-finished glass, underside lacquered in light grey	83	39.600,00	49.500,00
satin-finished glass, underside lacquered in white	82	39.600,00	49.500,00
solid natural oak, oiled finish	70	45.680,00	57.100,00
solid dark oak, with protective varnish	44	55.200,00	69.000,00
Carrara marble	50	90.480,00	113.100,00

Table top glass	Table top marble	Table top MDF	Table top solid wood	Base
82 white satin finish 83 light grey satin finish	50 marble Carrara	04 white powder-coated 30 basic dark powder-coated (textured)	04 dark stained solid oak, with protective varnish 70 natural solid oak, oiled	04 white powder-coated (textured) 30 basic dark powder-coated (textured)

Super Fold Table

Jasper Morrison, 2015

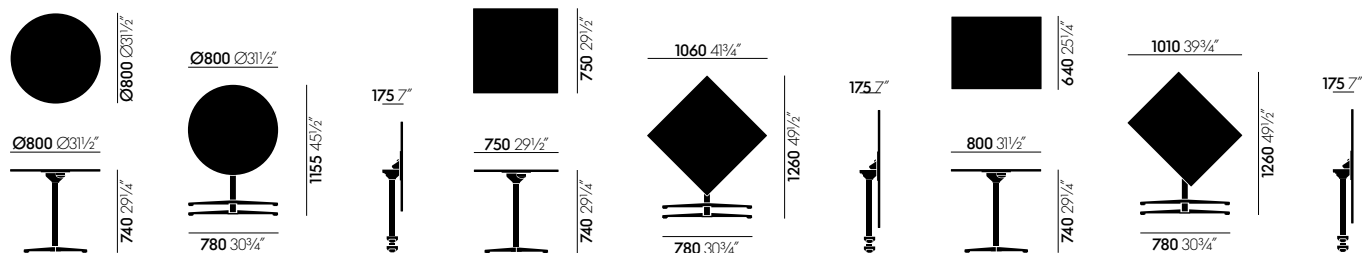

Table top: melamine faced in white with smooth straight plastic edge (19 mm), oak veneer (Europe) in natural or dark oak (19 mm) or solid core material with black edge (12 mm) in the colours white or black. Solid core table top in black with anti-fingerprint coating.

Folding mechanism: die-cast zinc.

Column: powder-coated steel in basic dark.

Base: die-cast aluminium.

Super Fold Table

Jasper Morrison, 2015

vitra.

Round table, indoor, Ø 796 mm

	Article no.	without VAT in SEK*	with VAT in SEK*
	443 021 01		
white melamine	03	11.440,00	14.300,00
white solid core material	01	12.880,00	16.100,00
black solid core material	30	12.880,00	16.100,00
light oak veneer	17	16.160,00	20.200,00
dark oak veneer	04	16.160,00	20.200,00

Rectangular table, indoor, 640 x 796 mm

	Article no.	without VAT in SEK*	with VAT in SEK*
	443 022 01		
melamine white	03	11.440,00	14.300,00
solid core material white	01	12.880,00	16.100,00
solid core material black	30	12.880,00	16.100,00
veneer light oak	17	16.160,00	20.200,00
veneer dark oak	04	16.160,00	20.200,00

Square table, indoor, 750 x 750 mm

	Article no.	without VAT in SEK*	with VAT in SEK*
	443 023 01		
melamine white	03	11.440,00	14.300,00
solid core material white	01	12.880,00	16.100,00
solid core material black	30	12.880,00	16.100,00
veneer light oak	17	16.160,00	20.200,00
veneer dark oak	04	16.160,00	20.200,00

Super Fold Table High

Jasper Morrison, 2015

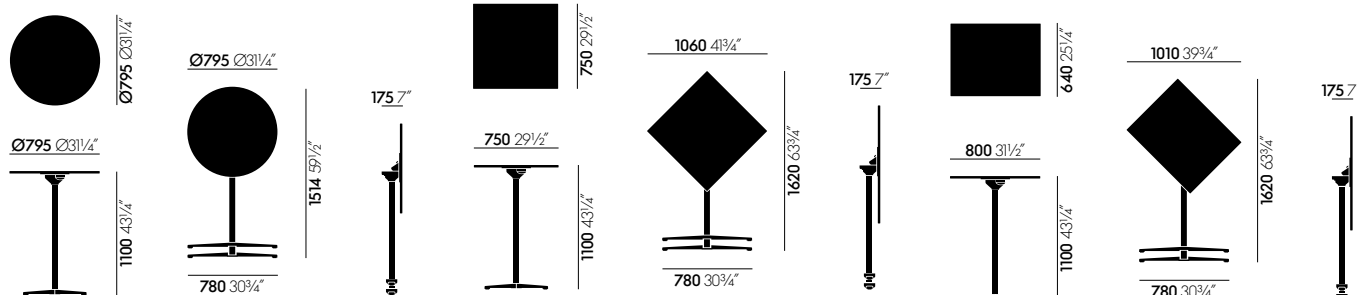

Table top: melamine faced in white with smooth straight plastic edge (19 mm), oak veneer (Europe) in natural or dark oak (19 mm) or solid core material with black edge (12 mm) in the colours white or black. Solid core table top in black with anti-fingerprint coating.

Folding mechanism: die-cast zinc.

Column: powder-coated steel in basic dark.

Base: die-cast aluminium.

Super Fold Table High

Jasper Morrison, 2015

vitra.

Round stand-up table, indoor, Ø 796 mm

	Article no.	without VAT in SEK*	with VAT in SEK*
	443 036 01		
white melamine	03	12.480,00	15.600,00
white solid core material	01	14.160,00	17.700,00
black solid core material	30	14.160,00	17.700,00
dark oak veneer	04	17.280,00	21.600,00
light oak veneer	17	17.280,00	21.600,00

Square stand-up table, indoor, 750 x 750 mm

	Article no.	without VAT in SEK*	with VAT in SEK*
	443 038 01		
white melamine	03	12.480,00	15.600,00
white solid core material	01	14.160,00	17.700,00
black solid core material	30	14.160,00	17.700,00
dark oak veneer	04	17.280,00	21.600,00
light oak veneer	17	17.280,00	21.600,00

Rectangular stand-up table, indoor, 640 x 796 mm

	Article no.	without VAT in SEK*	with VAT in SEK*
	443 037 01		
white melamine	03	12.480,00	15.600,00
white solid core material	01	14.160,00	17.700,00
black solid core material	30	14.160,00	17.700,00
dark oak veneer	04	17.280,00	21.600,00
light oak veneer	17	17.280,00	21.600,00

Table S.A.M. Bois

Jean Prouvé, 1941

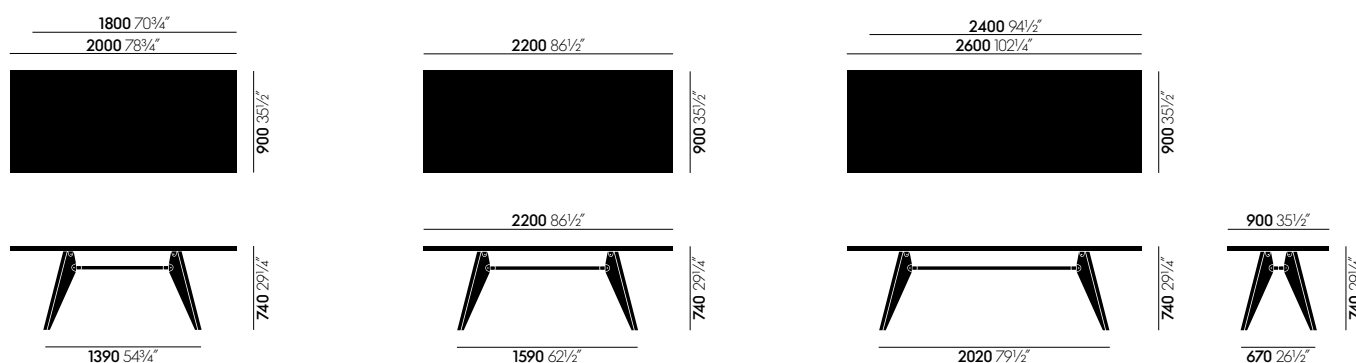

Table top: 34 mm thick; solid wood in natural oak with oiled finish, dark stained oak with protective natural lacquer finish, or American walnut with oiled finish.

Base: legs matched to table top, solid wood in natural oak with oiled finish, dark stained oak with protective natural lacquer finish, or American walnut with oiled finish; tubular steel crossbar with powder-coated finish (smooth).

Origin of wood: oak (*Quercus robur*) from Western Europe and/or Poland; American walnut (*Juglans nigra*) from the USA.

Table S.A.M. Bois

	Article no.	without VAT in SEK*	with VAT in SEK*
H 740 x W 900 x L 1800 mm	212 028 00		
natural solid oak, oiled	70	44.800,00	56.000,00
dark solid oak, with protective varnish	04	54.080,00	67.600,00
solid American walnut, oiled	75	63.680,00	79.600,00
H 740 x W 900 x L 2000 mm	212 029 00		
natural solid oak, oiled	70	48.160,00	60.200,00
dark solid oak, with protective varnish	04	56.400,00	70.500,00
solid American walnut, oiled	75	73.680,00	92.100,00
H 740 x W 900 x L 2200 mm	212 030 00		
natural solid oak, oiled	70	49.920,00	62.400,00
dark solid oak, with protective varnish	04	58.720,00	73.400,00
solid American walnut, oiled	75	78.800,00	98.500,00
H 740 x W 900 x L 2400 mm	212 031 00		
natural solid oak, oiled	70	58.000,00	72.500,00
dark solid oak, with protective varnish	04	68.000,00	85.000,00
solid American walnut, oiled	75	84.240,00	105.300,00
H 740 x W 900 x L 2600 mm	212 032 00		
natural solid oak, oiled	70	67.200,00	84.000,00
dark solid oak, with protective varnish	04	77.600,00	97.000,00
solid American walnut, oiled	75	88.880,00	111.100,00

Trapèze

Jean Prouvé, 1950/1954

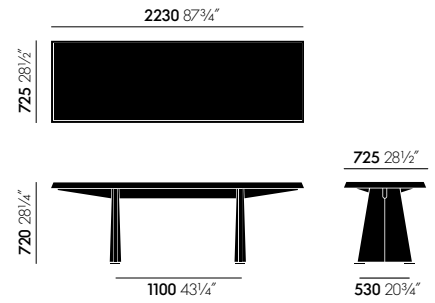

Table top: high-pressure laminate, black surface coating.

Base (legs and crossbeam): bent sheet steel, powder-coated in black.

Trapèze

		Article no.	without VAT in SEK*	with VAT in SEK*
H 720 x W 2230 x D 725 mm	black HPL	412 391 00	55.920,00	69.900,00

Desks



Compas Direction
Jean Prouvé
188



Eames Desk Unit EDU
Charles & Ray Eames
189



Home Desk
George Nelson
190

Office and conference chairs (swivel)

Chairs

Tables

Desks



Public waiting areas

Lounge chairs and armchairs

Sofas

Coffee and side tables

Stools and benches

Storage and partition elements

Accessories

Living, dining, decorative objects, home office,
clocks, lighting, publications

Quick Ship programme

General terms, conditions
and information

Compas Direction

Jean Prouvé, 1953

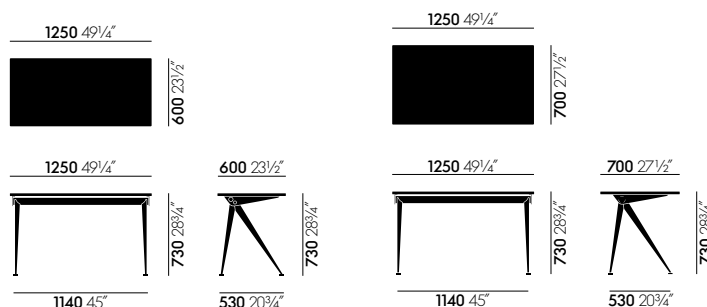

Table top: solid wood in natural oak with oiled finish, dark stained oak with protective natural lacquer finish, or American walnut with oiled finish.

Base: bent sheet steel, powder-coated finish (smooth).

Note: the steel frame in Métal Brut has a raw irregular surface protected by a transparent powder coating.

Origin of wood: oak (*Quercus robur*) from Western Europe and/or Poland; American walnut (*Juglans nigra*) from the USA.

Compas Direction

	Article no.	without VAT in SEK*	with VAT in SEK*
1250 x 600 mm	212 027 00		
solid natural oak, oiled	70	25.320,00	31.650,00
solid dark oak, with protective varnish	04	25.320,00	31.650,00
solid American walnut, oiled	75	27.560,00	34.450,00
Surcharges base			
Colour group 1		0,00	0,00
Colour group 2		1.352,00	1.690,00
1250 x 700 mm	212 060 00		
solid natural oak, oiled	70	26.200,00	32.750,00
solid dark oak, with protective varnish	04	26.200,00	32.750,00
solid American walnut, oiled	75	28.440,00	35.550,00
Surcharges base			
Base chocolate powder-coated (smooth), Color group 1	40	0,00	0,00
Colour group 2		1.352,00	1.690,00

Base frame Colour group 1

- 06 Japanese red powder-coated (smooth)
- 12 deep black powder-coated (smooth)
- 88 Prouvé Blanc Colombe (Ecrú) powder-coated (smooth)

Base frame Colour group 2

- 13 Prouvé Gris Vermeer powder-coated (smooth)
- 14 Prouvé Bleu Dynastie powder-coated (smooth)
- 18 Prouvé Blé Vert powder-coated (smooth)
- 41 Prouvé Bleu Marcoule powder-coated (smooth)
- 94 Prouvé Métal Brut powder-coated (transparent, smooth)

Eames Desk Unit EDU

Charles & Ray Eames, 1949

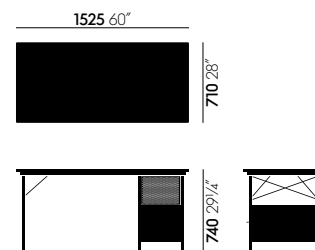

Table top: plywood with birch veneer (Poland and Finland).

Metal surfaces: black powder-coated finish.

Panels: powder-coated aluminium.

Shelves: maple plywood with birch face veneer (Poland and Finland), transparent lacquer finish.

Legs: individual levelling adjustment.

Applications: recommended for residential use only.

EDU

Article no.	without VAT in SEK*	with VAT in SEK*
213 025 11	14.680,00	18.350,00

Home Desk

George Nelson, 1958

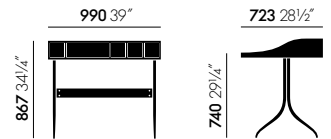

Top surfaces: high-pressure laminate in white, wooden side sections in walnut veneer.

Shelf dividers: polystyrene.

Base: swaged metal tubing, chrome-plated.

Range of use: recommended for residential use only.

Home Desk

		Article no.	without VAT in SEK*	with VAT in SEK*
walnut veneer	white HPL	412 503 00	34.320,00	42.900,00



Public Waiting



.04 beam seating
Maarten Van Severen
194



AIRLINE
Norman Foster
196



EPAC beam seating
Charles & Ray Eames
200



EPSC beam seating
Charles & Ray Eames
202



Tandem Seating
Charles & Ray Eames
204



HAL beam seating
Jasper Morrison
206



Meda Gate
Alberto Meda
209



Soft Wait
Barber & Osgerby
Prices and configurations can be found in OSC pro and pCon.



Soft Work
Barber & Osgerby
Prices and configurations can be found in OSC pro and pCon.

Chairs with row connectors in other chapters



DSS, DSS-N
Charles & Ray Eames
100



MedaSlim
Alberto Meda
131

Office and conference chairs (swivel)

Chairs

Tables

Desks

Public waiting areas

Lounge chairs and armchairs

Sofas

Coffee and side tables

Stools and benches

Storage and partition elements

Accessories

Living, dining, decorative objects, home office,
clocks, lighting, publications

Quick Ship programme

General terms, conditions
and information



.04 beam seating

Maarten Van Severen, 2000

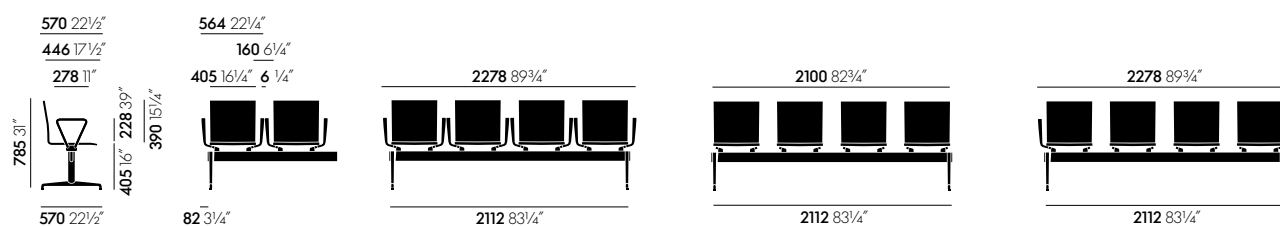

Backrest and seat: flexible backrest with integrated leaf springs. Polyurethane integral foam seat shell with upholstered effect, self-supporting on a steel frame.

Armrests: with or without armrests in integral foam.

Table units: black solid core material.

Base: T-beam and aluminium legs epoxy-coated. Equipped with plastic glides for carpet or anti-slip glides for hard floors.

.04 beam seating

Maarten Van Severen, 2000

.04 seat unit	Article no.	without VAT in SEK*	with VAT in SEK*
	440 084 00		
AO - without armrests	01	5.432,00	6.790,00
AR - with 1 armrest installed on the right	02	6.040,00	7.550,00
AL - with 1 armrest installed on the left	03	6.040,00	7.550,00
AB - with 2 armrests	04	6.760,00	8.450,00

.04 stretchers	Article no.	without VAT in SEK*	with VAT in SEK*
	440 086 00		
AO with 2 units	02	5.720,00	7.150,00
AR with 3 units	03	6.632,00	8.290,00
AL with 4 units	04	7.512,00	9.390,00
AB with 5 units	05	8.240,00	10.300,00

.04 table unit	Article no.	without VAT in SEK*	with VAT in SEK*
	440 085 00		
compact laminate black, 40 x 40 cm	01	3.912,00	4.890,00

Example of a three-seater

1 x AO	440 084 01 01	Unit without armrest
1 x T	440 085 00	Table unit
1 x AL	440 084 00 02	Unit with one armrest fitted on right
1 x	440 086 00 03	Unit with one armrest fitted on left
1 x	440 086 00	Stretcher for four units incl. two legs

The configuration is defined from right to left in sitting position.

The following combinations are possible using the table element
(version with and without armrests):



Seat shell

01 basic dark
10 bright red

Glides

04 glides for carpet
09 anti-slip glides

Airline

Norman Foster, 1998



Seat and back in polyurethane integral foam

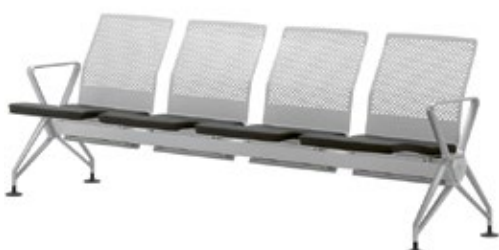

Back perforated, seat upholstered



Seat and back in maple veneer

All measurements are pursuant to EN 1335-1:2000
More detailed information is found in the chapter 'Explanation of measurements'.

Seat and backrest elements available in four versions: moulded maple plywood (clear lacquer finish); perforated steel; steel with padding (black vinyl cover); polyurethane integral skin foam (robust seat shell with upholstered effect, cantilevered on steel frame).

Armrests: die-cast aluminium, silver-colour coating.

Table units: black solid core material.

Base: triangular aluminium profile as the loadbearing element, anodised in silver-grey; die-cast aluminium legs, silver-colour coating; plastic glides for carpet.

Optional: side table with a top made of black solid core material.

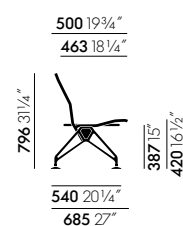

540 20¹/₄"
685 27"

500 19³/₄"
463 18¹/₄"

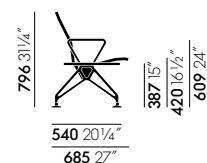

540 20¹/₄"
685 27"

500 19³/₄"
463 18¹/₄"

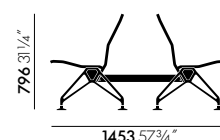

Airline

Norman Foster, 1998

Seat and back	Article no.	without VAT in SEK*	with VAT in SEK*
418 100 00			
S1 - seat and backrest perforated, non-upholstered	01	9.440,00	11.800,00
S3 - seat sheet steal non-perforated, upholstered; backrest perforated	03	10.720,00	13.400,00
S2 - seat and backrest sheet steel non-perforated, upholstered	02	11.840,00	14.800,00
W1 - seat and backrest in maple veneer	11	9.520,00	11.900,00
P1 - seat and backrest in polyurethane integral foam black	21	9.280,00	11.600,00
P3 - seat polyurethane integral foam; backrest maple veneer	23	9.280,00	11.600,00
Stretcher			
418 101 00			
B1 - 2 seat units	01	3.640,00	4.550,00
B2 - 3 seat units	02	4.920,00	6.150,00
B3 - 4 seat units	03	6.232,00	7.790,00
Leg			
418 102 00			
F1 - without armrest, with bridge	01	3.480,00	4.350,00
F2 - with armrest	02	4.080,00	5.100,00
Armrest between seating units			
418 103 00			
A1 - silver grey with fitting for double row connection	01	2.632,00	3.290,00
A2 - silver grey without fitting for double row connection, with fixation component	02	2.680,00	3.350,00
Table unit			
418 104 00			
TS - 300 x 500 mm, black	01	3.640,00	4.550,00
TB - 500 x 500 mm, black	02	5.080,00	6.350,00
Double row connection			
418 007 00			
L1 - with connection to the armrest	01	896,00	1.120,00
L2 - with connection to stretcher	02	1.800,00	2.250,00
Side table			
418 008 00			
textured silver grey	31	19.040,00	23.800,00

Airline

Norman Foster, 1998

MW: Factory assembled

MB: Assembled on site (assembly equipment on request)

Possible configurations:

- single row
- double row (back to back)
- single row with alternately positioned seats facing front and back ("kissing position")

Examples of orders for versions with integrated foam seat and back:

3 x P1	418 100 00 21	Integrated foam seat and back
1 x B3	418 101 00 03	base frame for four seating units
2 x F2	418 102 00 02	Leg with armrest
1 x TB	418 104 00 02	black compact laminate table unit

The configuration is defined from right to left in sitting position.

Sample configuration:

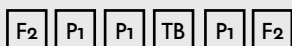

Notes:

Only the TS component can be used as a side table.

With two side tables the minimum configuration consists of three seating units.



A maximum of four elements (seating/table unit TB) and two side table units (TS) can be mounted on a stretcher with two legs. A double bench is always made up of at least two double connections (L1 or L2).

In the case of assembly ex works be sure to state the configuration sitting from right to left (see order example above).

Airline

Norman Foster, 1998

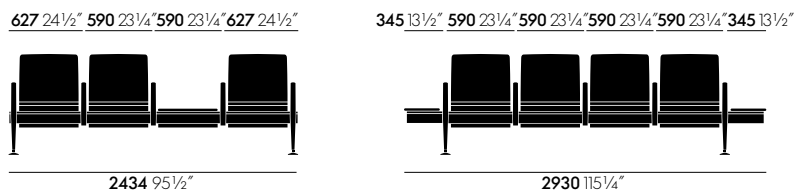
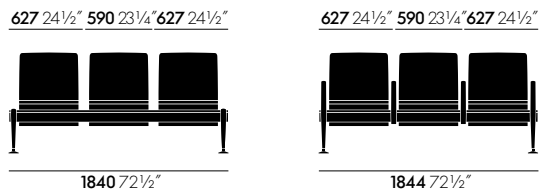
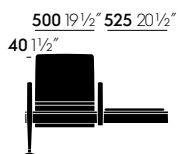
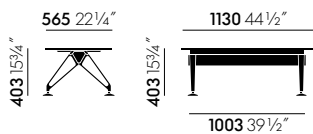
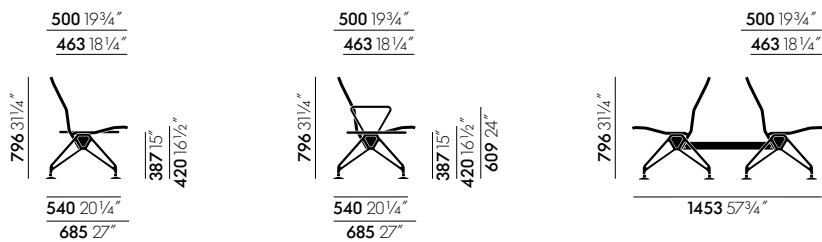

Eames Plastic Armchair beam seating

Charles & Ray Eames, 1950

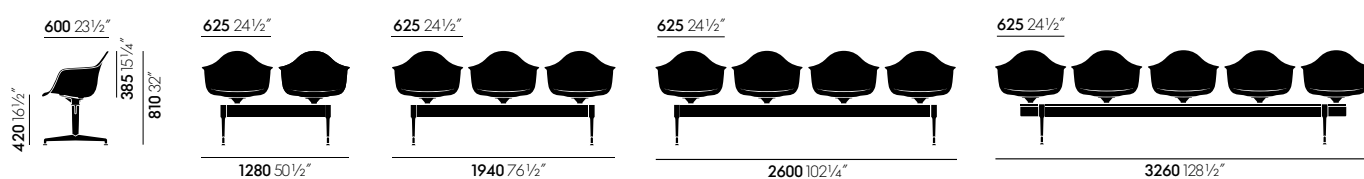

All measurements are pursuant to EN 1335-1:2000

More detailed information is found in the chapter 'Explanation of measurements'.

Seat shell: dyed-through polypropylene. All models are available with a seat cushion (screwed to the seat shell) or full upholstery. The fully upholstered version has moulded polyurethane foam padding covered in fabric, attached to the shell with a welted edge. Different shell and upholstery colours and various bases provide a multitude of possible combinations.

Options: the Eames Plastic Chair is available as a visitor chair, dining chair, rocking chair, swivel chair or in stacking versions and with ganging brackets for row seating. Beam-mounted shells are suited for use in waiting areas.

Table unit: black solid core material (560 x 430 mm).

Base: two-legged beam support in different lengths accommodates 2 to 5 chair shells or table units. T-beam: epoxy-coated in basic dark, polished aluminium legs. Fitted with plastic glides for carpet or anti-skid felt glides for hard floors.

Eames Plastic Armchair beam seating

Charles & Ray Eames, 1950

vitra.

Eames Plastic Armchair on beam

	Article no.	without VAT in SEK*	with VAT in SEK*
without upholstery	440 119 22		
2 seat units, 0 table units	51	18.720,00	23.400,00
2 seat units, 1 table unit	01	22.400,00	28.000,00
2 seat units, 2 table units	31	26.880,00	33.600,00
3 seat units, 0 table units	71	22.000,00	27.500,00
3 seat units, 1 table unit	11	26.400,00	33.000,00
3 seat units, 2 table units	41	30.720,00	38.400,00
4 seat units, 0 table units	81	26.320,00	32.900,00
4 seat units, 1 table unit	21	30.320,00	37.900,00
5 seat units, 0 table units	91	29.840,00	37.300,00
with seat upholstery fabric F60			
2 seat units, 0 table units	52	20.720,00	25.900,00
2 seat units, 1 table unit	02	24.640,00	30.800,00
2 seat units, 2 table units	32	29.040,00	36.300,00
3 seat units, 0 table units	72	25.120,00	31.400,00
3 seat units, 1 table unit	12	29.440,00	36.800,00
3 seat units, 2 table units	42	33.360,00	41.700,00
4 seat units, 0 table units	82	30.320,00	37.900,00
4 seat units, 1 table unit	22	34.000,00	42.500,00
5 seat units, 0 table units	92	34.640,00	43.300,00
with full upholstery fabric F60	440 169 00		
2 seat units, 0 table units	53	26.320,00	32.900,00
2 seat units, 1 table unit	03	30.320,00	37.900,00
2 seat units, 2 table units	33	34.640,00	43.300,00
3 seat units, 0 table units	73	33.360,00	41.700,00
3 seat units, 1 table unit	13	38.000,00	47.500,00
3 seat units, 2 table units	43	41.760,00	52.200,00
4 seat units, 0 table units	83	41.200,00	51.500,00
4 seat units, 1 table unit	23	44.960,00	56.200,00
5 seat units, 0 table units	93	48.320,00	60.400,00

Fabric F60	Seat shell	Edge	Glides
Hopsak	03 poppy red 04 white 11 pebble 12 deep black 23 ice grey 24 light grey 26 sunlight	34 mustard 41 pale rose 42 green 43 rusty orange 48 forest 56 granite grey 83 sea blue	01 basic dark 04 white 04 glides for carpet 09 anti-slip glides

Eames Plastic Side Chair beam seating

Charles & Ray Eames, 1950

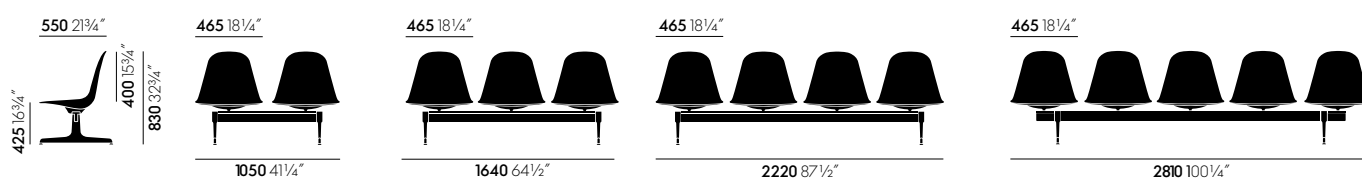

Seat shell: dyed-through polypropylene. All models are available with a seat cushion (screwed to the seat shell) or full upholstery. The fully upholstered version has moulded polyurethane foam padding covered in fabric, attached to the shell with a welted edge. Different shell and upholstery colours and various bases provide a multitude of possible combinations.

Options: the Eames Plastic Chair is available as a visitor chair, dining chair, rocking chair, swivel chair or in stacking versions and with ganging brackets for row seating. Beam-mounted shells are suited for use in waiting areas.

Table units: black solid core material (560 x 430 mm).

Base: two-legged base beams in different lengths accommodate 2 to 5 chair shells or table units. T-beam, epoxy-coated in basic dark, polished aluminium legs. Equipped with plastic glides for carpet or anti-skid felt glides for hard floors.

Eames Plastic Side Chair beam seating

Charles & Ray Eames, 1950

vitra.

Eames Plastic Side Chair on beam	Article no.	without VAT in SEK*	with VAT in SEK*
without upholstery	440 027 00		
2 seating units / 0 table unit	02	15.920,00	19.900,00
2 seating units / 1 table unit	21	19.760,00	24.700,00
2 seating un. / 2 table units	22	23.680,00	29.600,00
3 seating units / 0 table unit	03	18.160,00	22.700,00
3 seating units / 1 table unit	31	22.400,00	28.000,00
3 seating un. / 2 table units	32	26.320,00	32.900,00
4 seating units / 0 table unit	04	20.720,00	25.900,00
4 seating units / 1 table unit	41	24.640,00	30.800,00
5 seating units / 0 table unit	05	23.200,00	29.000,00
with seat upholstery fabric F60	440 177 00		
2 seating units / 0 table unit	02	18.160,00	22.700,00
2 seating units / 1 table unit	21	21.920,00	27.400,00
3 seating units / 0 table unit	03	21.360,00	26.700,00
3 seating units / 1 table unit	31	25.120,00	31.400,00
3 seating un. / 2 table units	32	29.040,00	36.300,00
4 seating units / 0 table unit	04	24.640,00	30.800,00
4 seating units / 1 table unit	41	28.480,00	35.600,00
5 seating units / 0 table unit	05	28.000,00	35.000,00
with full upholstery fabric F60	440 157 00		
2 seating units / 0 table unit	02	21.360,00	26.700,00
2 seating units / 1 table unit	21	25.280,00	31.600,00
3 seating units / 0 table unit	03	26.880,00	33.600,00
3 seating units / 1 table unit	31	30.800,00	38.500,00
3 seating un. / 2 table units	32	35.120,00	43.900,00
4 seating units / 0 table unit	04	32.480,00	40.600,00
4 seating units / 1 table unit	41	36.160,00	45.200,00
5 seating units / 0 table unit	05	38.000,00	47.500,00

Fabric F60	Seat shell	Edge	Glides
Hopsak	03 poppy red 04 white 11 pebble 12 deep black 23 ice grey 24 light grey 26 sunlight	34 mustard 41 pale rose 42 green 43 rusty orange 48 forest 56 granite grey 83 sea blue	01 basic dark 04 white 04 glides for carpet 09 anti-slip glides

Eames Tandem Seating ETS

Charles & Ray Eames, 1962

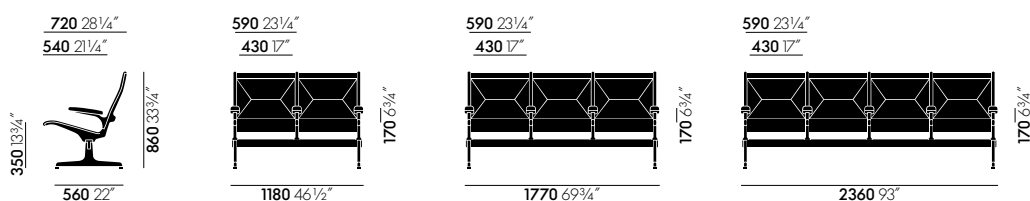

Backrest and seat: seat and back panels covered in vinyl or leather, padded sections with welded seams. Frame and armrest supports: chrome-plated die-cast aluminium.

Armrests: frame supports in chrome-plated die-cast aluminium, armrest pads made of integral polyurethane foam.

Base: substructure with T-beam in basic dark. T-legs in chrome-plated die-cast aluminium. Equipped with plastic glides for carpet or non-slip felt glides for hard floors.

Eames Tandem Seating ETS

Charles & Ray Eames, 1962

Basic seating unit TS-12	Article no.	without VAT in SEK*	with VAT in SEK*
2 armrests	962 037 00		
Vinyl		36.720,00	45.900,00
Leather L20		43.120,00	53.900,00

Additional seat unit TS-11	Article no.	without VAT in SEK*	with VAT in SEK*
	962 038 00		
Vinyl		24.080,00	30.100,00
Leather L20		30.240,00	37.800,00

TS single row	Article no.	without VAT in SEK*	with VAT in SEK*
TS-1 for 1 unit	926 018 00		
Base chromed	30	12.640,00	15.800,00
TS-2 for 2 units	926 019 00		
Base chromed	30	14.720,00	18.400,00
TS-3 for 3 units	926 020 00		
Base chromed	30	16.800,00	21.000,00
TS-4 for 4 units	926 021 00		
Base chromed	30	18.560,00	23.200,00

Leather L20	Vinyl ETS	Glides
Leather	76 antra II	04 glides for carpet 09 anti-slip glides

HAL beam seating

Jasper Morrison, 2019

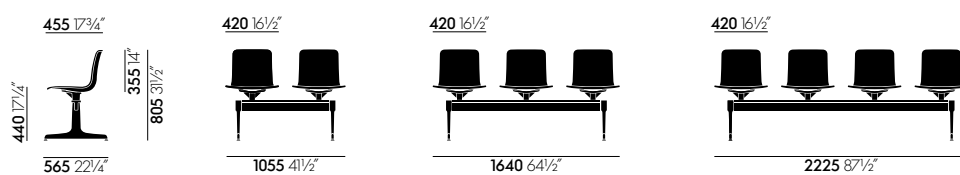

All measurements are pursuant to EN 1335-1:2000
 More detailed information is found in the chapter 'Explanation of measurements'.

Seat shell: dyed-through recycled polypropylene or plywood.

Table unit: black solid core material (560 x 430 mm).

Base: two-legged beam support in different lengths accommodates 2 to 5 chair shells or table units. T-beam with powder-coated finish, aluminium legs. Equipped with plastic glides for carpet or non-slip glides for hard floors.

HAL beam seating

Jasper Morrison, 2019

HAL beam seating	Article no.	without VAT in SEK*	with VAT in SEK*
	440 525 00		
2 seat units or table units	02	13.344,00	16.680,00
3 seat units or table units	03	16.288,00	20.360,00
4 seat units or table units	04	18.392,00	22.990,00
5 seat units or table units	05	20.272,00	25.340,00
2-seater bench			
Position 1			
seat, recycled polypropylene	01	848,00	1.060,00
seat, plywood	02	2.832,00	3.540,00
table unit, solid core mat.	03	1.352,00	1.690,00
Position 2			
seat, recycled polypropylene	01	848,00	1.060,00
seat, plywood	02	2.832,00	3.540,00
table unit, solid core mat.	03	1.352,00	1.690,00
3-seater bench			
Position 1			
seat, recycled polypropylene	01	848,00	1.060,00
seat, plywood	02	2.832,00	3.540,00
table unit, solid core mat.	03	1.352,00	1.690,00
Position 2			
seat, recycled polypropylene	01	848,00	1.060,00
seat, plywood	02	2.832,00	3.540,00
table unit, solid core mat.	03	1.352,00	1.690,00
Position 3			
seat, recycled polypropylene	01	848,00	1.060,00
seat, plywood	02	2.832,00	3.540,00
table unit, solid core mat.	03	1.352,00	1.690,00
4-seater bench			
Position 1			
seat, recycled polypropylene	01	848,00	1.060,00
seat, plywood	02	2.832,00	3.540,00
table unit, solid core mat.	03	1.352,00	1.690,00
Position 2			
seat, recycled polypropylene	01	848,00	1.060,00
seat, plywood	02	2.832,00	3.540,00
table unit, solid core mat.	03	1.352,00	1.690,00
Position 3			
seat, recycled polypropylene	01	848,00	1.060,00
seat, plywood	02	2.832,00	3.540,00
table unit, solid core mat.	03	1.352,00	1.690,00
Position 4			
seat, recycled polypropylene	01	848,00	1.060,00
seat, plywood	02	2.832,00	3.540,00
table unit, solid core mat.	03	1.352,00	1.690,00

Seat shell HAL RE	Seat shell HAL Ply	Glides
12 deep black RE	04 dark oak, with protective varnish	04 glides for carpet
14 ivy RE	10 natural oak, with protective varnish	09 anti-slip glides
23 ice grey RE		
29 brick RE		
31 warm grey RE		
35 basalt RE		
85 cotton white RE		
86 cardboard RE		

HAL beam seating

Jasper Morrison, 2019

vitra.

HAL beam seating	Article no.	without VAT in SEK*	with VAT in SEK*
5-seater bench			
Position 1			
seat, recycled polypropylene	01	848,00	1.060,00
seat, plywood	02	2.832,00	3.540,00
table unit, solid core mat.	03	1.352,00	1.690,00
Position 2			
seat, recycled polypropylene	01	848,00	1.060,00
seat, plywood	02	2.832,00	3.540,00
table unit, solid core mat.	03	1.352,00	1.690,00
Position 3			
seat, recycled polypropylene	01	848,00	1.060,00
seat, plywood	02	2.832,00	3.540,00
table unit, solid core mat.	03	1.352,00	1.690,00
Position 4			
seat, recycled polypropylene	01	848,00	1.060,00
seat, plywood	02	2.832,00	3.540,00
table unit, solid core mat.	03	1.352,00	1.690,00
Position 5			
seat, recycled polypropylene	01	848,00	1.060,00
seat, plywood	02	2.832,00	3.540,00
table unit, solid core mat.	03	1.352,00	1.690,00

Seat shell HAL RE

12 deep black RE
14 ivy RE
23 ice grey RE
29 brick RE
31 warm grey RE
35 basalt RE
85 cotton white RE
86 cardboard RE

Seat shell HAL Ply

04 dark oak, with protective varnish
10 natural oak, with protective varnish

Glides

04 glides for carpet
09 anti-slip glides

Meda Gate

Alberto Meda, 2011

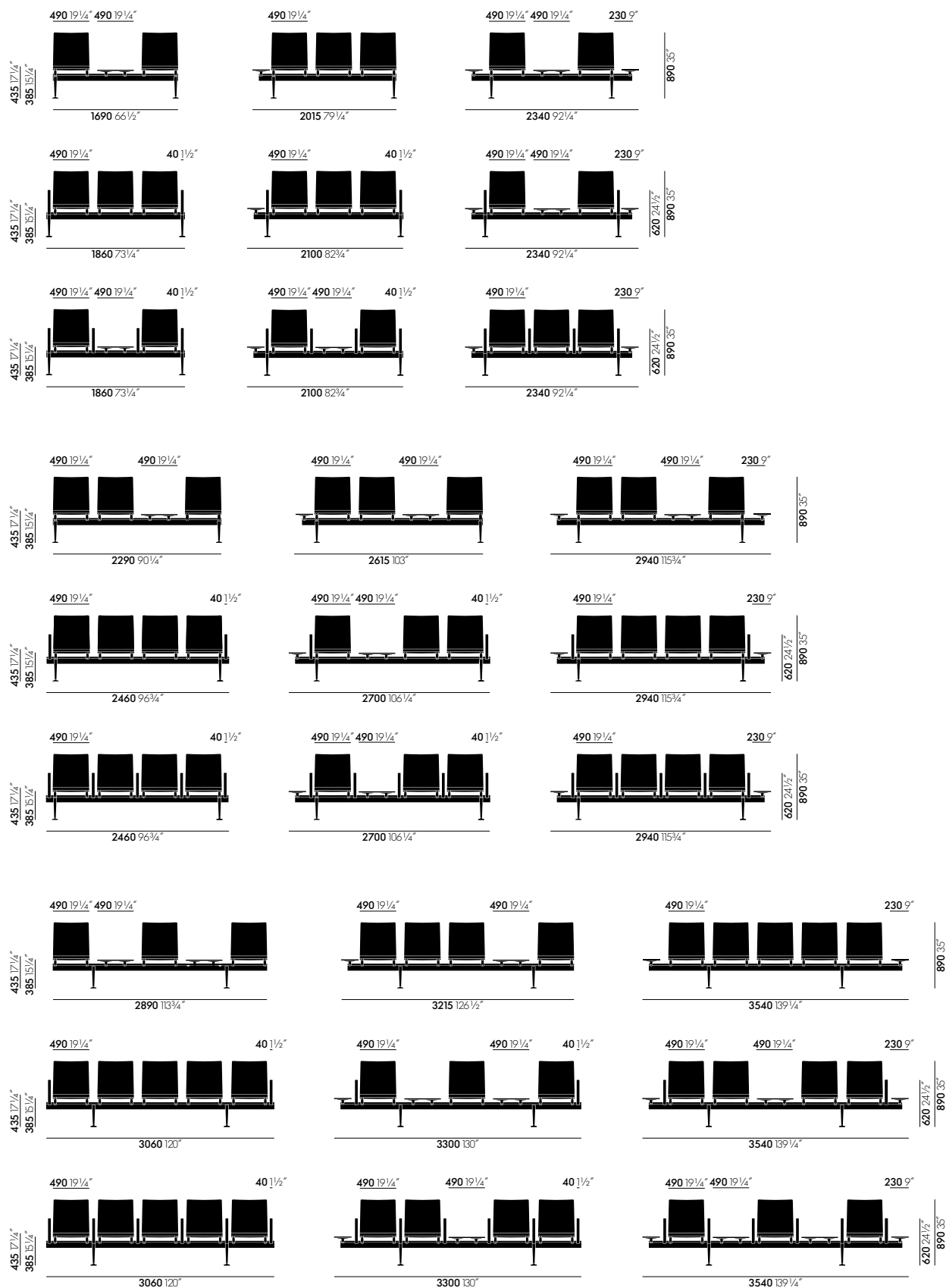

Meda Gate

Alberto Meda, 2011

vitra.

2 recliners with 3 table units (1x 490 x 520 mm / 2x 230 x 520 mm), with armrests	Article no.	without VAT in SEK*	with VAT in SEK*
	418 205 00		
Seat polyurethane foam, support profile anodised natural, legs coated	11	66.720,00	83.400,00
Seat leather, support profile anodised gloss, legs polished	22	86.160,00	107.700,00

Four-seater double bench with armrests	Article no.	without VAT in SEK*	with VAT in SEK*
	418 204 00		
Seat polyurethane foam, support profile anodised natural, legs coated	11	118.080,00	147.600,00
Seat leather, support profile anodised gloss, legs polished	22	174.800,00	218.500,00

Three-seater bench	Article no.	without VAT in SEK*	with VAT in SEK*
	418 220 00		
Position 1			
seat polyurethane integral foam	01	9.920,00	12.400,00
seat leather	02	15.280,00	19.100,00
table	03	6.712,00	8.390,00
Position 2			
seat polyurethane integral foam	01	9.920,00	12.400,00
seat leather	02	15.280,00	19.100,00
table	03	6.712,00	8.390,00
Position 3			
seat polyurethane integral foam	01	9.920,00	12.400,00
seat leather	02	15.280,00	19.100,00
table	03	6.712,00	8.390,00
Base and support profile			
powder-coated and natural anodised	01	11.760,00	14.700,00
polished/ gloss anodised	02	17.760,00	22.200,00
Armrests			
none	00	0,00	0,00
only outside	01	2.800,00	3.500,00
at all seats	02	5.560,00	6.950,00
Table unit lateral			
none	00	0,00	0,00
left (view from the front)	01	3.720,00	4.650,00
right (view from the front)	02	3.720,00	4.650,00
both sides	03	7.320,00	9.150,00
	Basic price:	41.520,00	51.900,00

Seat shell, polyurethane

01 basic dark
40 chocolate

Seat shell, leather Liso

66 nero
68 chocolate

Glides

04 glides for carpet
09 anti-slip glides

Meda Gate

Alberto Meda, 2011

vitra.

	Article no.	without VAT in SEK*	with VAT in SEK*
Four-seater bench			
		418 222 00	
Position 1			
seat polyurethane integral foam	01	9.920,00	12.400,00
seat leather	02	15.280,00	19.100,00
table	03	6.712,00	8.390,00
Position 2			
seat polyurethane integral foam	01	9.920,00	12.400,00
seat leather	02	15.280,00	19.100,00
table	03	6.712,00	8.390,00
Position 3			
seat polyurethane integral foam	01	9.920,00	12.400,00
seat leather	02	15.280,00	19.100,00
table	03	6.712,00	8.390,00
Position 4			
seat polyurethane integral foam	01	9.920,00	12.400,00
seat leather	02	15.280,00	19.100,00
table	03	6.712,00	8.390,00
Base and support profile			
powder-coated and natural anodised	01	12.800,00	16.000,00
polished/ gloss anodised	02	19.440,00	24.300,00
Armrests			
none	00	0,00	0,00
only outside	01	2.800,00	3.500,00
at all seats	02	6.840,00	8.550,00
Table unit lateral			
none	00	0,00	0,00
left (view from the front)	01	3.720,00	4.650,00
right (view from the front)	02	3.720,00	4.650,00
both sides	03	7.320,00	9.150,00
	Basic price:	52.480,00	65.600,00

Seat shell, polyurethane

01 basic dark
40 chocolate

Seat shell, leather Liso

66 nero
68 chocolate

Glides

04 glides for carpet
09 anti-slip glides

Five-seater bench	Article no.	without VAT in SEK*	with VAT in SEK*
		418 224 00	
Position 1			
seat polyurethane integral foam	01	9.920,00	12.400,00
seat leather	02	15.280,00	19.100,00
table	03	6.712,00	8.390,00
Position 2			
seat polyurethane integral foam	01	9.920,00	12.400,00
seat leather	02	15.280,00	19.100,00
table	03	6.712,00	8.390,00
Position 3			
seat polyurethane integral foam	01	9.920,00	12.400,00
seat leather	02	15.280,00	19.100,00
table	03	6.712,00	8.390,00
Position 4			
seat polyurethane integral foam	01	9.920,00	12.400,00
seat leather	02	15.280,00	19.100,00
table	03	6.712,00	8.390,00
Position 5			
seat polyurethane integral foam	01	9.920,00	12.400,00
seat leather	02	15.280,00	19.100,00
table	03	6.712,00	8.390,00
Base and support profile			
powder-coated and natural anodised	01	14.080,00	17.600,00
polished/ gloss anodised	02	21.360,00	26.700,00
Armrests			
none	00	0,00	0,00
only outside	01	2.800,00	3.500,00
at all seats	02	8.240,00	10.300,00
Table unit lateral			
none	00	0,00	0,00
left (view from the front)	01	3.720,00	4.650,00
right (view from the front)	02	3.720,00	4.650,00
both sides	03	7.320,00	9.150,00
	Basic price:	63.680,00	79.600,00

Seat shell, polyurethane

01 basic dark
40 chocolate

Seat shell, leather Liso

66 nero
68 chocolate

Glides

04 glides for carpet
09 anti-slip glides

Lounge chairs and armchairs



Amoebe
Verner Panton
216



EA 124/125
Charles & Ray Eames
217



EA 222/223
Charles & Ray Eames
218



ES 106
Charles & Ray Eames
219



Citizen Lowback
Konstantin Grcic
220



Citizen Highback
Konstantin Grcic
221



Cité
Jean Prouvé
222



Coconut Chair
George Nelson
223



Cone Chair
Verner Panton
224



Heart Cone Chair
Verner Panton
225



RAR Fiberglass
Charles & Ray Eames
226



RAR
Charles & Ray Eames
227



East River Chair
Hella Jongerius
228



Fauteuil de Salon
Jean Prouvé
229



Grand Relax
Antonio Citterio
230



HAL Lounge Chair
Jasper Morrison
232



Lounge Chair
Charles & Ray Eames
234



La Chaise
Charles & Ray Eames
242



LCM
Charles & Ray Eames
243



LCW
Charles & Ray Eames
244



Organic Highback
Charles Eames &
Eero Saarinen
245



Repos
Antonio Citterio
246



Grand Repos
Antonio Citterio
248



Petit Repos
Antonio Citterio
251



Slow Chair
R & E Bouroullec
252

Compatible products in other chapters



Mariposa Club Armchair
Barber & Osgerby
309



Suita Club Armchair
Antonio Citterio
356

Office and conference chairs (swivel)

Chairs

Tables

Desks

Public waiting areas

Lounge chairs and armchairs

Sofas

Coffee and side tables

Stools and benches

Storage and partition elements

Accessories

Living, dining, decorative objects, home office,
clocks, lighting, publications

Quick Ship programme

General terms, conditions
and information



Amoebe

Verner Panton, 1970

vitra.



Amoebe

Amoebe Highback



Backrest: laminated frame.

Upholstery: polyurethane foam.

Seat height: 350 mm (215 mm with applied load, measured in accordance with EN 1335-1:2000).

Amoebe	Article no.	without VAT in SEK*	with VAT in SEK*
	210 004 00		
Fabric F60		14.080,00	17.600,00
Fabric F100		16.240,00	20.300,00

Amoebe Highback	Article no.	without VAT in SEK*	with VAT in SEK*
	210 235 00		
Fabric F60		21.600,00	27.000,00
Fabric F100		24.880,00	31.100,00

Fabric F60

Fabric F100

. Velo

. Tonus

Aluminium Chair EA 124/125

Charles & Ray Eames, 1958



EA 124



EA 125

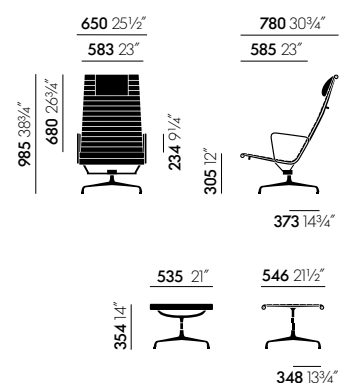

All measurements are pursuant to EN 1335-1:2000
More detailed information is found in the chapter 'Explanation of measurements'.

EA 124

Backrest and seat: chair with high backrest. High-frequency welded upholstery with horizontal ribbing; cover in fabric or leather. Side profiles and spreaders in die-cast aluminium, with a polished or chrome-plated finish or powder-coated in deep black.

Seat mechanism: adjustable backward tilt.

Armrests: die-cast aluminium, with a polished or chrome-plated finish or powder-coated in deep black.

Base: four-star base in die-cast aluminium, with a polished or chrome-plated finish or powder-coated in deep black.

EA 125

Seat: non-swivel. Upholstered with high-frequency welded ribbing in fabric or leather. Side profiles and spreaders in die-cast aluminium, with a polished or chrome-plated finish or powder-coated in deep black.

Base: four-star base in die-cast aluminium, with a polished or chrome-plated finish or powder-coated in deep black.

EA 124

	Article no.	without VAT in SEK*	with VAT in SEK*
swivel	412 366 00		
with armrests			
Fabric F60		32.800,00	41.000,00
Leather L20		40.240,00	50.300,00
Leather L50		46.400,00	58.000,00
Surcharges base			
polished	1	0,00	0,00
powder-coated in deep black	4	0,00	0,00
chromed	0	2.920,00	3.650,00

EA 125

	Article no.	without VAT in SEK*	with VAT in SEK*
stool	412 367 00		
non-swivel			
Fabric F60		13.520,00	16.900,00
Leather L20		16.400,00	20.500,00
Leather L50		18.080,00	22.600,00
Surcharges base			
polished	1	0,00	0,00
powder-coated in deep black	4	0,00	0,00
chromed	0	864,00	1.080,00

Fabric F60

· Hopsak

Leather L20

· Leather/back panel Plano

Leather L50

· Leather Premium F/back panel Plano

Glides

04 glides for carpet
05 felt glides for hard floor

Soft Pad Chair EA 222/223

Charles & Ray Eames, 1969

vitra.



EA 222



EA 223

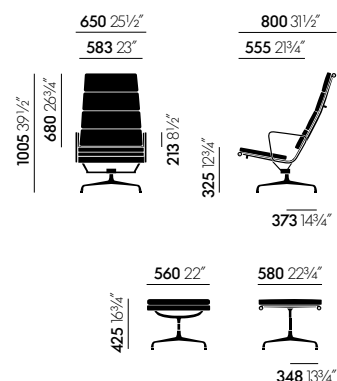

All measurements are pursuant to EN 1335-1:2000

More detailed information is found in the chapter 'Explanation of measurements'.

EA 222

Backrest and seat: chair with high backrest. Five sewn-on cushions with polyurethane foam upholstery in leather. Side profiles and spreaders in die-cast aluminium, with a polished or chrome-plated finish or powder-coated in deep black.

Seat mechanism: adjustable backward tilt.

Armrests: die-cast aluminium, with a polished or chrome-plated finish or powder-coated in deep black.

Base: four-star base in die-cast aluminium, with a polished or chrome-plated finish or powder-coated in deep black.

EA 223

Seat: non-swivel. Sewn-on cushion with polyurethane foam upholstery in leather. Side profiles and spreaders in die-cast aluminium, with a polished or chrome-plated finish or powder-coated in deep black.

Base: four-star base in die-cast aluminium, with a polished or chrome-plated finish or powder-coated in deep black.

EA 222

	Article no.	without VAT in SEK*	with VAT in SEK*
swivel	412 383 00		
with armrests			
Leather L20		42.960,00	53.700,00
Leather L50		49.280,00	61.600,00
Surcharges base			
polished	1	0,00	0,00
powder-coated in deep black	4	0,00	0,00
chromed	0	2.920,00	3.650,00

EA 223

	Article no.	without VAT in SEK*	with VAT in SEK*
Stool	412 384 00		
non-swivel			
Leather L20		17.600,00	22.000,00
Leather L50		20.320,00	25.400,00
Surcharges base			
polished	1	0,00	0,00
powder-coated in deep black	4	0,00	0,00
chromed	0	864,00	1.080,00

Leather L20

Leather/back panel Plano

Leather L50

Leather Premium F (contrast seam)/back panel Plano

Glides

04 glides for carpet
05 felt glides for hard floor

Soft Pad Chaise ES 106

Charles & Ray Eames, 1968

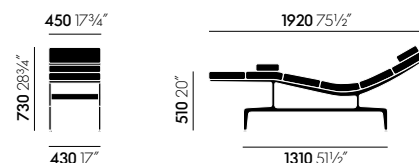

Upholstery/cover: padded leather upholstery, six fixed and two loose cushions.

Base: die-cast aluminium, powder-coated (smooth).

Range of use: recommended for residential use only.

ES 106

	Article no.	without VAT in SEK*	with VAT in SEK*
	412 034 00		
Leather L20		62.560,00	78.200,00
Leather L50		71.200,00	89.000,00

Leather L20

Leather/back panel Plano

Leather L50

Leather Premium F (contrast seam)/back panel Plano

Glides

04 glides for carpet
05 felt glides for hard floor



Citizen

Konstantin Grcic, 2020

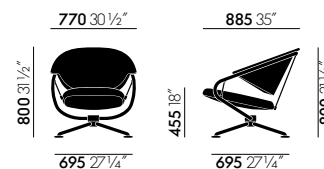

Citizen Lowback

All measurements are pursuant to EN 1335-1:2000
More detailed information is found in the chapter 'Explanation of measurements'.

Frame: tubular steel, powder-coated in deep black (textured finish).

Back: support shell in rigid polyurethane foam, encased in moulded polyurethane foam.

Neck cushion (Citizen Highback): filled with a mix of 50% polyester fibre and 50% ball fibre.

Seat: metal inserts, encased in moulded polyurethane foam. Suspended on frame by means of three steel cables, cathodic dip coating in black.

Cover: fabric or leather.

Seat height: 455 mm (320 mm with applied load, measured in accordance with EN 1335-1:2000).

Base: four-star swivel base made of tubular steel, powder-coated in deep black (textured finish), plastic glides with felt inserts.

Citizen Lowback	Article no.	without VAT in SEK*	with VAT in SEK*
		210 652 00	
Fabric F30		24.560,00	30.700,00
Fabric F40		24.880,00	31.100,00
Fabric F80		26.480,00	33.100,00
Fabric F120		28.000,00	35.000,00
Leather L20		32.560,00	40.700,00
Leather L50		39.440,00	49.300,00

Fabric F30	Fabric F40	Fabric F80	Fabric F120	Leather L20	Leather L50
. Plano	. Laser RE	. Cosy 2	. Credo . Track	. Leather	. Leather Premium F

Citizen

Konstantin Grcic, 2020

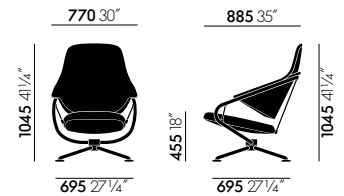

Citizen Highback

All measurements are pursuant to EN 1335-1:2000
More detailed information is found in the chapter 'Explanation of measurements'.

Frame: tubular steel, powder-coated in deep black (textured finish).

Back: support shell in rigid polyurethane foam, encased in moulded polyurethane foam.

Neck cushion (Citizen Highback): filled with a mix of 50% polyester fibre and 50% ball fibre.

Seat: metal inserts, encased in moulded polyurethane foam. Suspended on frame by means of three steel cables, cathodic dip coating in black.

Cover: fabric or leather.

Seat height: 455 mm (320 mm with applied load, measured in accordance with EN 1335-1:2000).

Base: four-star swivel base made of tubular steel, powder-coated in deep black (textured finish), plastic glides with felt inserts.

Citizen Highback

	Article no.	without VAT in SEK*	with VAT in SEK*
		210 651 00	
Fabric F30		32.080,00	40.100,00
Fabric F40		32.400,00	40.500,00
Fabric F80		34.320,00	42.900,00
Fabric F120		36.160,00	45.200,00
Leather L20		43.760,00	54.700,00
Leather L50		52.000,00	65.000,00
Surcharges neck support cushion			
Fabric F30		1.368,00	1.710,00
Fabric F40		1.432,00	1.790,00
Fabric F80		1.800,00	2.250,00
Fabric F100		1.912,00	2.390,00
Fabric F120		2.120,00	2.650,00
Leather L20		3.192,00	3.990,00
Leather L50		4.200,00	5.250,00

Fabric F30	Fabric F40	Fabric F80	Fabric F100 - for neck cushion	Fabric F120	Leather L20	Leather L50
· Plano	· Laser RE	· Cosy 2	· Aura	· Credo Track	· Leather	· Leather Premium F

Cité

Jean Prouvé, 1930

vitra.

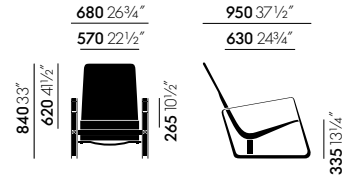

Cover: seat and backrest with a continuous cover in fabric or leather.

Upholstery: neck cushion in polyurethane foam, height-adjustable.

Seat height: 335 mm (210 mm with applied load, measured in accordance with EN 1335-1).

Base: bent sheet steel, powder-coated finish (smooth).

Glides: fitted with plastic glides for carpet; felt glides for hard floors optionally available.

Note: the steel frame in Métal Brut has a raw irregular surface protected by a transparent powder coating.

Cité

	Article no.	without VAT in SEK*	with VAT in SEK*
	210 437 00		
Fabric F40		31.680,00	39.600,00
Fabric F80		33.440,00	41.800,00
Leather L50		43.360,00	54.200,00
Surcharges base			
Colour group 1		0,00	0,00
Colour group 2		920,00	1.150,00

Fabric F40	Fabric F80	Leather L50
. Mello	. Tress	. Leather Premium F

Base frame Colour group 1

06 Japanese red powder-coated (smooth)
12 deep black powder-coated (smooth)
88 Prouvé Blanc Colombe (Ecrú) powder-coated (smooth)

Base frame Colour group 2

13 Prouvé Gris Vermeer powder-coated (smooth)
14 Prouvé Bleu Dynastie powder-coated (smooth)
18 Prouvé Blé Vert powder-coated (smooth)
41 Prouvé Bleu Marcoule powder-coated (smooth)
94 Prouvé Métal Brut powder-coated (transparent, smooth)

Glides

04 glides for carpet
05 felt glides for hard floor

Coconut Chair

George Nelson, 1955



Shell: glass fibre reinforced plastic in white.

Upholstery: one-piece polyurethane foam padding.

Seat height: 295 mm (255 mm with applied load, measured in accordance with EN 1335-1:2000).

Base: tubular steel, polished chrome finish.

Glides: fitted with plastic glides for carpet; felt glides for hard floors optionally available.

Coconut Chair

	Article no.	without VAT in SEK*	with VAT in SEK*
		210 459 00	
Fabric F60		35.920,00	44.900,00
Leather L20		50.240,00	62.800,00
Leather L50		56.160,00	70.200,00

Fabric F60

. Hopsak

Leather L20

. Leather

Leather L50

. Leather Premium F

Glides

04 glides for carpet
05 felt glides for hard floor



Cone Chair

Verner Panton, 1958

vitra.

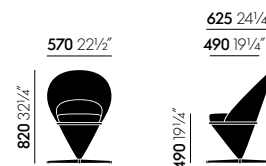
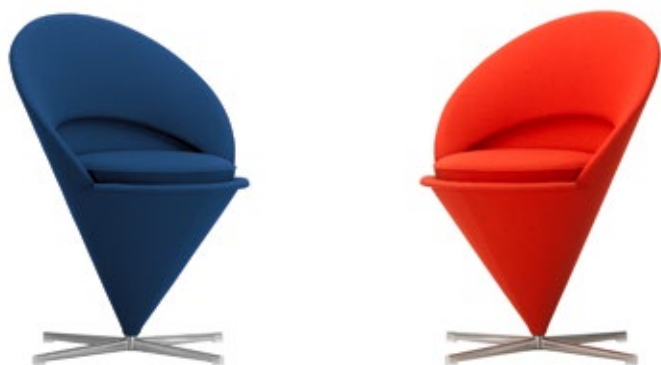

Body: GRP (glass fibre reinforced plastic laminate).

Upholstery: lightly padded with polyurethane foam. Seat cushion.

Base: stainless steel cruciform base, satin finish.

Glides: plastic.

Cone Chair

	Article no.	without VAT in SEK*	with VAT in SEK*
	406 004 00		
Fabric F100		21.280,00	26.600,00

Fabric F100

. Tonus

Heart Cone Chair

Verner Panton, 1958

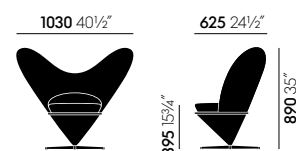

Body: GRP (glass fibre reinforced plastic laminate).

Upholstery: polyurethane foam.

Seat height: 395 mm (applied load 380 mm, measured in accordance with EN 1335-1:2000).

Base: stainless steel cruciform base, satin finish.

Glides: plastic.

Heart Cone Chair

	Article no.	without VAT in SEK*	with VAT in SEK*
	406 003 00		
Fabric F100		30.720,00	38.400,00

Fabric F100

. Tonus

Eames Fiberglass Chairs

Charles & Ray Eames, 1950

vitra.

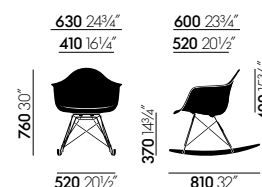

All measurements are pursuant to EN 1335-1:2000
More detailed information is found in the chapter 'Explanation of measurements'.

Seat shell: dyed-through, glass-fibre reinforced polyester (fibreglass). Just like the earliest models, today's fibreglass shells are also slightly transparent in some colours. Optionally available with a moulded foam seat cushion (screwed to the seat shell); cushion can be replaced by the Vitra service team.

RAR

	Article no.	without VAT in SEK*	with VAT in SEK*
rocking chair	440 455 00		
without upholstery		9.480,00	11.850,00
rocking chair	440 456 00		
with seat upholstery			
Fabric F60		10.432,00	13.040,00
Fabric F200		11.680,00	14.600,00

Fabric F60	Fabric F200	Seat shell (Eames Fiberglass Armchair)	Base RAR	Rocking skids RAR
· Hopsak	· Checker	01 Eames Parchment 04 Eames Elephant Hide Grey 05 Eames Sea Foam Green 06 Eames Raw Umber	01 chrome 04 white powder-coated (smooth) 30 basic dark powder-coated (smooth)	02 golden maple 95 dark maple

Eames Plastic Armchair RAR

Charles & Ray Eames, 1950

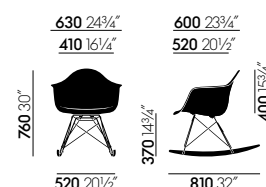

All measurements are pursuant to EN 1335-1:2000
More detailed information is found in the chapter 'Explanation of measurements'.

Seat shell: dyed-through polypropylene. All models are available with a seat cushion (screwed to the seat shell) or full upholstery. The fully upholstered version has moulded polyurethane foam padding covered in fabric, attached to the shell with a welted edge. Different shell and upholstery colours and various bases provide a multitude of possible combinations.

Options: the Eames Plastic Chair is available as a visitor chair, dining chair, rocking chair, swivel chair or in stacking versions and with ganging brackets for row seating. Beam-mounted shells are suited for use in waiting areas.

Eames Plastic Armchair RAR

RAR base: wire base with cross struts, chrome-plated or powder-coated, solid maple runners. (RAR = Rocking Armchair Rod Base)

Origin of wood: maple (*Acer platanoides*) from Western Europe and/or Poland.

RAR	Article no.	without VAT in SEK*	with VAT in SEK*
rocking chair	440 365 00		
without seat upholstery		5.952,00	7.440,00
rocking chair	440 366 00		
with seat upholstery			
Fabric F60		6.904,00	8.630,00
Fabric F200		8.152,00	10.190,00
rocking chair	440 367 00		
with full upholstery			
Fabric F60		8.768,00	10.960,00

Fabric F60	Fabric F200	Seat shell	Base RAR	Rocking skids RAR
Hopsak	Checker	03 poppy red 04 white 11 pebble 12 deep black 23 ice grey 24 light grey 26 sunlight	34 mustard 41 pale rose 42 green 43 rusty orange 48 forest 56 granite grey 83 sea blue	01 chrome 04 white powder-coated (smooth) 30 basic dark powder-coated (smooth) 02 golden maple 95 dark maple

East River Chair

Hella Jongerius, 2014

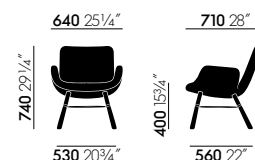

Seat shell: laminated.

Upholstery: polyurethane foam with fabric and leather cover.

Cover: Premium Leather and various fabrics (Laser, Hopsak, Plano) in coordinated colour combinations.

Seat height: 400 mm (330 mm with applied load, measured in accordance with EN 1335-1).

Base: legs in natural oak with steel cross braces powder-coated in ivory or dark oak legs with braces powder-coated in coffee.

Glides: fitted with plastic glides for carpet, felt glides for hard floors additionally included.

Origin of wood: oak (Quercus robur) from Western Europe and/or Poland.

East River Chair

	Article no.	without VAT in SEK*	with VAT in SEK*
	210 441 00		
Fabric mix		22.320,00	27.900,00

Note: you will find an overview of the colour and fabric combinations for the different sofa versions in the supplement entitled 'Cover materials'.

Light mix 01

- 05 Plano - cream white/sierra grey
- 65 Laser RE - ice blue/cream
- 71 Leather Premium F - sand
- 71 Hopsak - yellow/pastel green

Red mix 02

- 63 Hopsak - red/poppy red
- 71 Leather Premium F - sand
- 74 Laser RE - nude/light red
- 96 Plano - red/cognac

Green mix 04

- 63 Laser RE - warm grey/cream
- 67 Leather Premium F - asphalt
- 69 Plano - dark grey
- 70 Hopsak - grass green/forest

Blue mix 05

- 20 Laser RE - ice blue/moor brown
- 66 Plano - nero
- 67 Leather Premium F - asphalt
- 84 Hopsak - blue/moor brown

Base

- 04 dark stained solid oak, with protective varnish
- 10 natural oak, with protective varnish

Fauteuil de Salon

Jean Prouvé, 1939

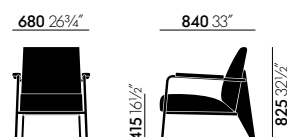

Seat and backrest: polyurethane filling; cover in fabric or leather.

Seat height: 415 mm (340 mm with applied load, measured in accordance with EN 1335-1:2000).

Armrests: solid wood in natural oak with oiled finish, dark stained oak with protective natural lacquer finish, or American walnut with oiled finish.

Base: bent sheet steel and tubular steel, powder-coated (smooth).

Glides: hard glides for carpet or felt glides for hard floors.

Origin of wood: oak (*Quercus robur*) from Western Europe and/or Poland; American walnut (*Juglans nigra*) from the USA.

Note: the steel frame in „Métal Brut“ has a raw irregular surface protected by a transparent powder coating.

Fauteuil de Salon

	Article no.	without VAT in SEK*	with VAT in SEK*
	210 438 00		
Fabric F60		26.080,00	32.600,00
Fabric F80		26.720,00	33.400,00
Fabric F100		27.280,00	34.100,00
Leather L50		36.160,00	45.200,00
Surcharges base			
Colour group 1		0,00	0,00
Colour group 2		920,00	1.150,00

Fabric F60	Fabric F80	Fabric F100	Leather L50	Armrests	Glides
· Twill	· Tress	· Nubia	· Leather Premium F	04 dark stained solid oak, with protective varnish	04 glides for carpet
· Valo				70 natural solid oak, oiled	05 felt glides for hard floor
				75 solid American walnut, oiled	

Base frame Colour group 1

06 Japanese red powder-coated (smooth)
12 deep black powder-coated (smooth)
88 Prouvé Blanc Colombe (Ecrú) powder-coated (smooth)

Base frame Colour group 2

13 Prouvé Gris Vermeer powder-coated (smooth)
14 Prouvé Bleu Dynastie powder-coated (smooth)
18 Prouvé Blé Vert powder-coated (smooth)
41 Prouvé Bleu Marcoule powder-coated (smooth)
94 Prouvé Métal Brut powder-coated (transparent, smooth)

Grand Relax

Antonio Citterio, 2019



Seat/body: moulded polyurethane foam with plastic frame and integrated synchronised mechanism with locking device.

Seat heights: 415 mm (310 mm with applied load, measured in accordance with EN 1335-1:2000) or 465 mm (360 mm with applied load, measured in accordance with EN 1335-1:2000).

Base: four-star swivel base in die-cast aluminium, polished or powder-coated finish.

Seat cushion: chamber cushion filled with polyurethane foam lozenges and ball fibres.

Back cushion and neck cushion: chamber cushion filled with polyurethane foam cubes and a mix of goose feathers and down.

Note: Cushions should be regularly shaken and plumped to retain their original fullness and shape.

Note: The back shell, the understructure of the seat and ottoman, and the adjustment knob for backrest resistance are covered in Leather Forte (decorative split leather).

Note: The base version determines the finish of the other metal parts (mechanism control lever, cap on resistance adjustment knob).

Note: total height with headrest in highest position 1080 or 1130 mm.

Ottoman: MDF panel covered with polyurethane foam and polyester fleece; chamber cushion filled with polyurethane foam lozenges and ball fibres.

Base: non-swivel four-star base in die-cast aluminium, polished or powder-coated finish.

Glides: fitted with plastic glides for soft floors or felt glides for hard floors.

Grand Relax

Antonio Citterio, 2019

vitra.

Grand Relax	Article no.	without VAT in SEK*	with VAT in SEK*
	210 590 00		
Fabric F80		49.120,00	61.400,00
Fabric F100		51.120,00	63.900,00
Leather L50		65.360,00	81.700,00

Grand Relax & Ottoman	Article no.	without VAT in SEK*	with VAT in SEK*
	210 592 00		
Fabric F80		65.680,00	82.100,00
Fabric F100		68.320,00	85.400,00
Leather L50		89.200,00	111.500,00

Grand Relax Ottoman	Article no.	without VAT in SEK*	with VAT in SEK*
	210 591 00		
Fabric F80		16.560,00	20.700,00
Fabric F100		17.200,00	21.500,00
Leather L50		23.840,00	29.800,00

Fabric F80	Fabric F100	Leather L50	Leather Forte (deco)
. Corsaro	. Nubia	. Leather Premium F	01 cognac (dark)
. Cosy 2			02 marron (dark)
. Dumet			03 umbra grey
			04 chocolate
			05 nero
			07 sand

Base	Glides	Seat height	Height Ottoman
03 polished aluminium	04 glides for carpet	01 low (415 mm)	01 low (395 mm)
30 basic dark powder-coated (smooth)	05 felt glides for hard floor	02 high (465 mm)	02 high (445 mm)



HAL Lounge Chair

Jasper Morrison, 2021

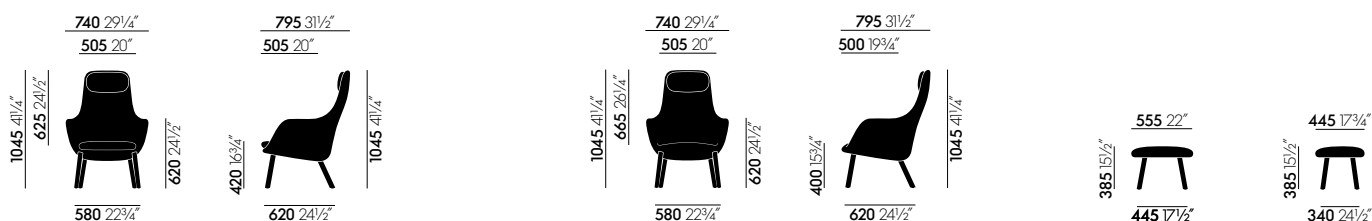

HAL Lounge Chair with loose cushion

HAL Lounge Chair integrated cushion

HAL Lounge Chair Ottoman

All measurements are pursuant to EN 1335-1:2000

More detailed information is found in the chapter 'Explanation of measurements'.

Chair/body: fibreglass-reinforced plastic shell made from post-industrial recycled ABS plastic, encased in moulded polyurethane foam.

Neck cushion filling: ball fibres and siliconised fibres.

Filling loose seat cushion: polyurethane foam.

Base: natural oak or dark oak; connection between shell and base made of die-cast aluminium, powder-coated in dim grey.

Seat heights: armchair with loose seat cushion 420 mm (320 mm with applied load, measured in accordance with EN 1335-1:2000); armchair with integrated seat cushion 400 mm (320 mm with applied load, measured in accordance with EN 1335-1:2000).

Ottoman: plywood panel, polyurethane foam and polyester fibre.

Base: natural oak or dark oak, leg connection in fibreglass-reinforced plastic.

Origin of wood: oak (*Quercus robur*) from Western Europe and/or Poland.

Glides: plastic glides for carpet or felt glides for hard floors.

Covers: removable.

HAL Lounge Chair

Jasper Morrison, 2021

vitra.

HAL Lounge Chair	Article no.	without VAT in SEK*	with VAT in SEK*
with integrated seat cushion	440 481 00		
Fabric F40		24.640,00	30.800,00
Fabric F60		26.320,00	32.900,00
Fabric F80		27.840,00	34.800,00
Fabric F100		28.720,00	35.900,00
Fabric F120		30.320,00	37.900,00
Leather L50		40.480,00	50.600,00
with loose seat cushion	440 480 00		
Fabric F40		27.520,00	34.400,00
Fabric F60		29.200,00	36.500,00
Fabric F80		30.960,00	38.700,00
Fabric F100		31.920,00	39.900,00
Fabric F120		33.600,00	42.000,00
Leather L50		43.840,00	54.800,00

HAL Lounge Chair & Ottoman	Article no.	without VAT in SEK*	with VAT in SEK*
with integrated seat cushion	440 483 00		
Fabric F40		33.280,00	41.600,00
Fabric F60		35.200,00	44.000,00
Fabric F80		37.040,00	46.300,00
Fabric F100		38.080,00	47.600,00
Fabric F120		40.480,00	50.600,00
Leather L50		52.960,00	66.200,00
with loose seat cushion	440 482 00		
Fabric F40		36.160,00	45.200,00
Fabric F60		38.080,00	47.600,00
Fabric F80		40.160,00	50.200,00
Fabric F100		41.280,00	51.600,00
Fabric F120		43.760,00	54.700,00
Leather L50		56.320,00	70.400,00

HAL Lounge Ottoman	Article no.	without VAT in SEK*	with VAT in SEK*
	440 484 00		
Fabric F40		8.640,00	10.800,00
Fabric F60		8.880,00	11.100,00
Fabric F80		9.200,00	11.500,00
Fabric F100		9.360,00	11.700,00
Fabric F120		10.160,00	12.700,00
Leather L50		12.480,00	15.600,00

Fabric F40	Fabric F60	Fabric F80	Fabric F100	Fabric F120	Leather L50	Glides	Base
· Laser RE	· Volo	· Cosy 2 · Dumet	· Nubia	· Credo	· Leather Premium F	04 glides for carpet 05 felt glides for hard floor	04 dark stained solid oak, with protective varnish 10 natural oak, with protective varnish

Lounge Chair

Charles & Ray Eames, 1956

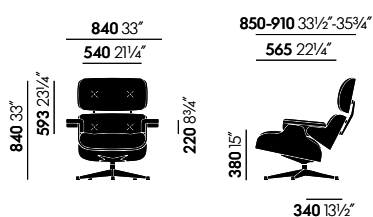

Lounge Chair classic dimensions

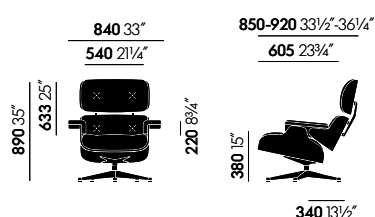

Lounge Chair new dimensions

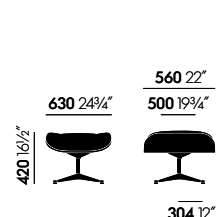

Lounge Chair Ottoman

Seat and back: moulded plywood, different face veneers. Classic version in American cherry (USA), santos palisander (Bolivia; certified sustainability) or black-pigmented walnut (USA). White version: white-pigmented walnut (USA). Black version: ash with a black lacquer finish (Germany).

Upholstery/Cover: removable cushion units, covers in leather.

Seat height: 380 mm (250 mm with applied load, measured in accordance with EN 1335-1:2000).

Armrests: upholstered in leather, attached to the seat and back shells with shock mounts (bonded rubber and metal connectors).

Base: five-star swivel base or four-star non-swivel base (Ottoman). Both base and back braces in die-cast aluminium.

Glides: all bases fitted with hard glides for carpet; felt glides optionally available for hard floors.

Lounge Chair

Charles & Ray Eames, 1956

Lounge Chair & Ottoman - santos palisander	Article no.	without VAT in SEK*	with VAT in SEK*
		412 122 00	
polished	1	100.648,00	125.810,00
polished / sides black	2	98.568,00	123.210,00
Surcharge Leather			
Leather L50		0,00	0,00
Leather L60		10.864,00	13.580,00

Lounge Chair - santos palisander	Article no.	without VAT in SEK*	with VAT in SEK*
		412 123 00	
polished	1	73.904,00	92.380,00
polished / sides black	2	72.864,00	91.080,00
Surcharge Leather			
Leather L50		0,00	0,00
Leather L60		8.004,00	10.005,00

Ottoman - santos palisander	Article no.	without VAT in SEK*	with VAT in SEK*
		412 124 00	
polished	1	26.744,00	33.430,00
polished / sides black	2	25.704,00	32.130,00
Surcharge leather			
Leather L50		0,00	0,00
Leather L60		2.860,00	3.575,00

Note: the choice of colours for the Lounge Chair is coordinated with the veneer and cannot be modified.

Leather Premium F (Santos palisander) - L50

66 nero
68 chocolate
72 snow
77 brown
87 plum
93 brandy

Leather Natural F (Santos palisander) - L60

01 caramel
66 nero
68 chocolate
78 dark sand

Glides

04 glides for carpet
05 felt glides for hard floor

Dimensions

01 classic dimensions
02 new dimensions



Lounge Chair

Charles & Ray Eames, 1956

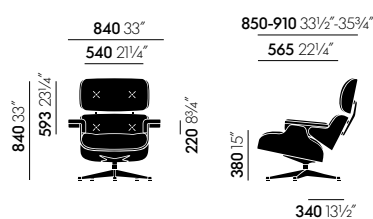

Lounge Chair classic dimensions

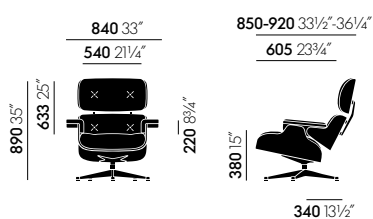

Lounge Chair new dimensions

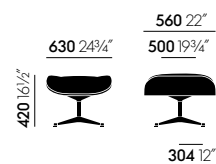

Lounge Chair Ottoman

Seat and back: moulded plywood, different face veneers. Classic version in American cherry (USA), santos palisander (Bolivia; certified sustainability) or black-pigmented walnut (USA). White version: white-pigmented walnut (USA). Black version: ash with a black lacquer finish (Germany).

Upholstery/Cover: removable cushion units, covers in leather.

Seat height: 380 mm (250 mm with applied load, measured in accordance with EN 1335-1:2000).

Armrests: upholstered in leather, attached to the seat and back shells with shock mounts (bonded rubber and metal connectors).

Base: five-star swivel base or four-star non-swivel base (Ottoman). Both base and back braces in die-cast aluminium.

Glides: all bases fitted with hard glides for carpet; felt glides optionally available for hard floors.

Lounge Chair

Charles & Ray Eames, 1956

Lounge Chair & Ottoman - black-pigmented walnut	Article no.	without VAT in SEK*	with VAT in SEK*
		412 125 00	
polished	1	89.752,00	112.190,00
polished / sides black	2	87.672,00	109.590,00
Surcharge leather			
Leather L50		0,00	0,00
Leather L60		10.864,00	13.580,00

Lounge Chair - black-pigmented walnut	Article no.	without VAT in SEK*	with VAT in SEK*
		412 126 00	
polished	1	66.608,00	83.260,00
polished / sides black	2	65.568,00	81.960,00
Surcharge leather			
Leather L50		0,00	0,00
Leather L60		8.004,00	10.005,00

Ottoman - black-pigmented walnut	Article no.	without VAT in SEK*	with VAT in SEK*
		412 127 00	
polished	1	23.144,00	28.930,00
polished / sides black	2	22.104,00	27.630,00
Surcharge leather			
Leather L50		0,00	0,00
Leather L60		2.860,00	3.575,00

Note: the choice of colours for the Lounge Chair is coordinated with the veneer and cannot be modified.

Leather Premium F (black-pigmented walnut) - L50

61 umbra grey
66 nero
68 chocolate
69 marron
72 snow
77 brown

Leather Natural F (black-pigmented walnut) - L60

01 caramel
66 nero
68 chocolate
78 dark sand

Glides

04 glides for carpet
05 felt glides for hard floor

Dimensions

01 classic dimensions
02 new dimensions

Lounge Chair

Charles & Ray Eames, 1956

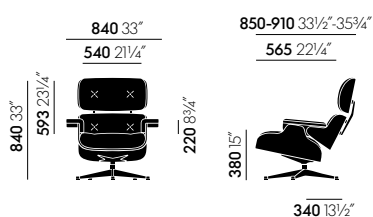

Lounge Chair classic dimensions

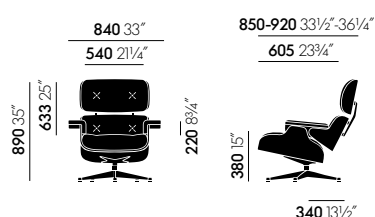

Lounge Chair new dimensions

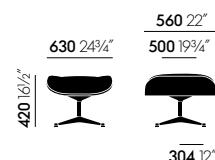

Lounge Chair Ottoman

Seat and back: moulded plywood, different face veneers. Classic version in American cherry (USA), santos palisander (Bolivia; certified sustainability) or black-pigmented walnut (USA). White version: white-pigmented walnut (USA). Black version: ash with a black lacquer finish (Germany).

Upholstery/Cover: removable cushion units, covers in leather.

Seat height: 380 mm (250 mm with applied load, measured in accordance with EN 1335-1:2000).

Armrests: upholstered in leather, attached to the seat and back shells with shock mounts (bonded rubber and metal connectors).

Base: five-star swivel base or four-star non-swivel base (Ottoman). Both base and back braces in die-cast aluminium.

Glides: all bases fitted with hard glides for carpet; felt glides optionally available for hard floors.

Lounge Chair

Charles & Ray Eames, 1956

Lounge Chair & Ottoman - american cherry	Article no.	without VAT in SEK*	with VAT in SEK*
	412 133 00		
polished	1	81.056,00	101.320,00
polished / sides black	2	78.976,00	98.720,00
Surcharge leather			
Leather L50		0,00	0,00
Leather L60		10.864,00	13.580,00

Lounge Chair - american cherry	Article no.	without VAT in SEK*	with VAT in SEK*
	412 134 00		
polished	1	59.516,00	74.395,00
polished / sides black	2	58.476,00	73.095,00
Surcharge leather			
Leather L50		0,00	0,00
Leather L60		8.004,00	10.005,00

Ottoman - american cherry	Article no.	without VAT in SEK*	with VAT in SEK*
	412 135 00		
polished	1	21.540,00	26.925,00
polished / sides black	2	20.500,00	25.625,00
Surcharge leather			
Leather L50		0,00	0,00
Leather L60		2.860,00	3.575,00

Note: the choice of colours for the Lounge Chair is coordinated with the veneer and cannot be modified.

Leather Premium F (American cherry) - L50

58 khaki
61 umbra grey
66 nero
68 chocolate
71 sand
72 snow
77 brown

Leather Natural F (American cherry) - L60

01 caramel
66 nero
68 chocolate
78 dark sand

Glides

04 glides for carpet
05 felt glides for hard floor

Dimensions

01 classic dimensions
02 new dimensions



Lounge Chair

Charles & Ray Eames, 1956

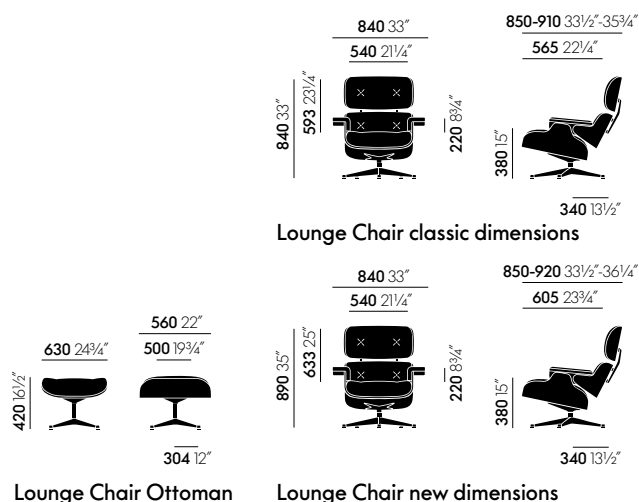

Seat and back: moulded plywood, different face veneers. Classic version in American cherry (USA), santos palisander (Bolivia; certified sustainability) or black-pigmented walnut (USA). White version: white-pigmented walnut (USA). Black version: ash with a black lacquer finish (Germany).

Upholstery/Cover: removable cushion units, covers in leather.

Seat height: 380 mm (250 mm with applied load, measured in accordance with EN 1335-1:2000).

Armrests: upholstered in leather, attached to the seat and back shells with shock mounts (bonded rubber and metal connectors).

Base: five-star swivel base or four-star non-swivel base (Ottoman). Both base and back braces in die-cast aluminium.

Glides: all bases fitted with hard glides for carpet; felt glides optionally available for hard floors.

Lounge Chair & Ottoman - white-pigmented walnut

	Article no.	without VAT in SEK*	with VAT in SEK*
		412 116 00	
polished	1	89.752,00	112.190,00
Surcharge leather			
Leather L50		0,00	0,00
Leather L60		10.864,00	13.580,00

Lounge Chair - white-pigmented walnut

	Article no.	without VAT in SEK*	with VAT in SEK*
		412 117 00	
polished	1	66.608,00	83.260,00
Surcharge leather			
Leather L50		0,00	0,00
Leather L60		8.004,00	10.005,00

Ottoman - white-pigmented walnut

	Article no.	without VAT in SEK*	with VAT in SEK*
		412 118 00	
polished	1	23.144,00	28.930,00
Surcharge leather			
Leather L50		0,00	0,00
Leather L60		2.860,00	3.575,00

Note: the choice of colours for the Lounge Chair is coordinated with the veneer and cannot be modified.

Leather Premium F (white-pigmented walnut) - L50

72 snow
73 clay
74 olive

Leather Natural F (white-pigmented walnut) - L60

78 dark sand

Glides

04 glides for carpet
05 felt glides for hard floor

Dimensions

01 classic dimensions
02 new dimensions

Lounge Chair

Charles & Ray Eames, 1956

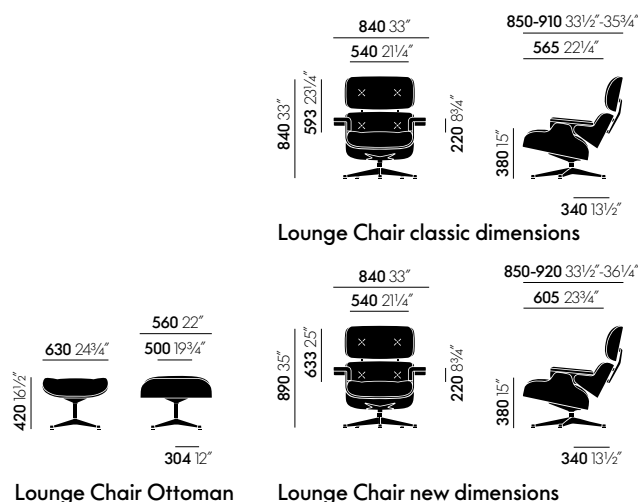

Seat and back: moulded plywood, different face veneers. Classic version in American cherry (USA), santos palisander (Bolivia; certified sustainability) or black-pigmented walnut (USA). White version: white-pigmented walnut (USA). Black version: ash with a black lacquer finish (Germany).

Upholstery/Cover: removable cushion units, covers in leather.

Seat height: 380 mm (250 mm with applied load, measured in accordance with EN 1335-1:2000).

Armrests: upholstered in leather, attached to the seat and back shells with shock mounts (bonded rubber and metal connectors).

Base: five-star swivel base or four-star non-swivel base (Ottoman). Both base and back braces in die-cast aluminium.

Glides: all bases fitted with hard glides for carpet; felt glides optionally available for hard floors.

Lounge Chair & Ottoman - black ash

	Article no.	without VAT in SEK*	with VAT in SEK*
	412 119 00		
black coated	3	89.752,00	112.190,00
Surcharge leather			
Leather L50		0,00	0,00
Leather L60		10.864,00	13.580,00

Lounge Chair - black ash

	Article no.	without VAT in SEK*	with VAT in SEK*
	412 120 00		
black coated	3	66.608,00	83.260,00
Surcharge leather			
Leather L50		0,00	0,00
Leather L60		8.004,00	10.005,00

Ottoman - black ash

	Article no.	without VAT in SEK*	with VAT in SEK*
	412 121 00		
black coated	3	23.144,00	28.930,00
Surcharge leather			
Leather L50		0,00	0,00
Leather L60		2.860,00	3.575,00

Note: the choice of colours for the Lounge Chair is coordinated with the veneer and cannot be modified.

Leather Premium F (black ash) - L50	Leather Natural F (black ash) - L60	Glides	Dimensions
66 nero	66 nero	04 glides for carpet	01 classic dimensions
67 asphalt	68 chocolate	05 felt glides for hard floor	02 new dimensions
68 chocolate			

La Chaise

Charles & Ray Eames, 1948

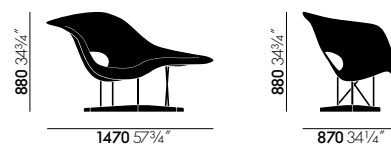

Shell: polyester resin, white lacquer finish.

Base: chrome-plated tubular steel.

Cruciform base: solid natural oak, protective natural lacquer finish.

Origin of wood: oak (*Quercus robur*) from Western Europe and/or Poland.

La Chaise

	Article no.	without VAT in SEK*	with VAT in SEK*
white shell	412 100 01	89.040,00	111.300,00

Plywood Group

Charles & Ray Eames, 1945/1946

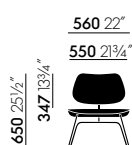

LCM

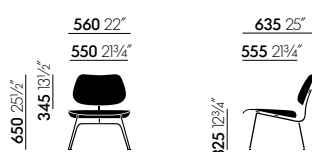

LCM Calf's Skin

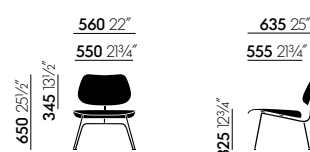

LCM Leather

All measurements are pursuant to EN 1335-1:2000
More detailed information is found in the chapter 'Explanation of measurements'.

LCM = Lounge Chair Metal

Back/seat: moulded plywood with face veneer in ash or walnut.

Upholstery: thin foam padding, covered in leather (LCW Leather) or calfskin hide (LCW Calf's Skin).

Base: tubular steel, chrome-plated or powder-coated. Seat and backrest attached to the base with shock mounts (bonded rubber and metal connectors).

LCM

	Article no.	without VAT in SEK*	with VAT in SEK*
			210 548 00
natural ash (new)	64	9.600,00	12.000,00
black ash	68	9.600,00	12.000,00
black-pigmented walnut	45	10.480,00	13.100,00

LCM Calf's Skin

	Article no.	without VAT in SEK*	with VAT in SEK*
			210 549 00
natural ash (new), hide brown / white	64	21.360,00	26.700,00
black ash, hide black / white	68	21.360,00	26.700,00

LCM Leather

	Article no.	without VAT in SEK*	with VAT in SEK*
			210 550 00
natural ash (new), leather nero	64	19.120,00	23.900,00
black ash, leather nero	68	19.120,00	23.900,00
black-pigmented walnut, leather nero	45	20.000,00	25.000,00

Base (DCM, LCM)

01 chrome
30 basic dark powder-coated (smooth)

Glides (DCM, LCM)

04 glides for carpet
05 felt glides for hard floor

Plywood Group

Charles & Ray Eames, 1945/1946



LCW



LCW Calf's Skin



LCW Leather

All measurements are pursuant to EN 1335-1:2000
More detailed information is found in the chapter 'Explanation of measurements'.

LCW = Lounge Chair Wood

Back/seat: moulded plywood with face veneer in ash or walnut.

Upholstery: thin foam padding, covered in leather (LCW Leather) or calfskin hide (LCW Calf's Skin).

Base: moulded plywood with same face veneer as the back and seat. Seat and backrest attached to the base with shock mounts (bonded rubber and metal connectors).

LCW

	Article no.	without VAT in SEK*	with VAT in SEK*
			210 551 00
natural ash	64	15.200,00	19.000,00
black ash	68	15.200,00	19.000,00
black-pigmented walnut	45	17.520,00	21.900,00

LCW Calf's Skin

	Article no.	without VAT in SEK*	with VAT in SEK*
			210 552 00
natural ash (new), hide brown / white	64	27.360,00	34.200,00
black ash, hide black / white	68	27.360,00	34.200,00

LCW Leather

	Article no.	without VAT in SEK*	with VAT in SEK*
			210 553 00
natural ash (new), leather nero	64	25.120,00	31.400,00
black ash, leather nero	68	25.120,00	31.400,00
black-pigmented walnut, leather nero	45	27.520,00	34.400,00

Organic Highback

Charles Eames & Eero Saarinen, 1940

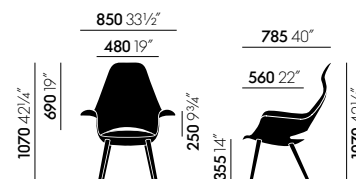

All measurements are pursuant to EN 1335-1:2000
More detailed information is found in the chapter 'Explanation of measurements'.

Seat shell: laminated.

Upholstery: polyurethane foam with fabric cover.

Legs: black ash or natural oak.

Glides: fitted with plastic glides for carpet, felt glides for hard floors additionally included.

Origin of wood: oak (*Quercus robur*) and ash (*Fraxinus excelsior*) from Western Europe and/or Poland.

Organic Highback

	Article no.	without VAT in SEK*	with VAT in SEK*
	210 009 00		
Fabric F60		22.240,00	27.800,00
Fabric F80		23.360,00	29.200,00
Fabric F100		24.240,00	30.300,00
Fabric F120		25.040,00	31.300,00

Fabric F60

. Hopsak

Fabric F80

. Cosy 2

Fabric F100

. Tonus

Fabric F120

. Credo

Legs

10 natural oak, with protective varnish
68 black ash

Repos

Antonio Citterio, 2011



Repos & Ottoman

Panchina 750

Repos

Chair/body: moulded polyurethane foam with webbed plastic frame and integrated synchronised mechanism with locking device.

Cover: fabric or leather, removable.

Seat heights: 400 mm (310 mm with applied load, measured in accordance with EN 1335-1:2000) or 450 mm (360 mm with applied load, measured in accordance with EN 1335-1:2000).

Base: four-star base in die-cast aluminium, polished or powder-coated finish.

Note: the base version determines the finish of the mechanism control lever.

Neck pillow: filled with feathers.

Repos

Antonio Citterio, 2011

vitra.

Repos	Article no.	without VAT in SEK*	with VAT in SEK*
	210 746 00		
Fabric F60		38.800,00	48.500,00
Fabric F80		39.680,00	49.600,00
Fabric F100		41.440,00	51.800,00
Fabric F120		43.840,00	54.800,00
Leather L20		45.600,00	57.000,00
Leather L50		61.440,00	76.800,00
Leather L60		71.920,00	89.900,00

Repos & Ottoman	Article no.	without VAT in SEK*	with VAT in SEK*
	210 747 00		
Fabric F60		53.040,00	66.300,00
Fabric F80		54.400,00	68.000,00
Fabric F100		56.640,00	70.800,00
Fabric F120		60.000,00	75.000,00
Leather L20		62.720,00	78.400,00
Leather L50		85.360,00	106.700,00
Leather L60		99.280,00	124.100,00

Repos & Panchina	Article no.	without VAT in SEK*	with VAT in SEK*
W 750 mm	210 748 00		
Fabric F60		47.760,00	59.700,00
Fabric F80		48.880,00	61.100,00
Fabric F100		50.800,00	63.500,00
Fabric F120		54.320,00	67.900,00
Leather L20		55.840,00	69.800,00
Leather L50		74.800,00	93.500,00
Leather L60		86.480,00	108.100,00

Fabric F60	Fabric F80	Fabric F100	Fabric F120	Leather L20	Leather L50	Leather L60
. Valo . Dumet	. Cosy 2 (cross stitch) . Dumet	. Nubia	. Credo	. Leather (contrast seam)	. Leather Premium F (contrast seam)	. Leather Natural F (contrast seam)

Base	Glides	Seat height	Height Ottoman
03 polished aluminium 30 basic dark powder-coated (smooth)	04 glides for carpet 05 felt glides for hard floor	01 low (400 mm) 02 high (450 mm)	01 low (425 mm) 02 high (475 mm)

Grand Repos

Antonio Citterio, 2011



Grand Repos & Ottoman

Panchina 750

Grand Repos

Chair/body: moulded polyurethane foam with webbed plastic frame and integrated synchronised mechanism with locking device.

Cover: fabric or leather, removable.

Seat heights: 400 mm (310 mm with applied load, measured in accordance with EN 1335-1:2000) or 450 mm (360 mm with applied load, measured in accordance with EN 1335-1:2000).

Base: four-star base in die-cast aluminium, polished or powder-coated finish.

Note: the base version determines the finish of the mechanism control lever.

Neck pillow: filled with feathers.

Grand Repos

Antonio Citterio, 2011

vitra.

Grand Repos	Article no.	without VAT in SEK*	with VAT in SEK*
	210 749 00		
Fabric F60		42.880,00	53.600,00
Fabric F80		43.840,00	54.800,00
Fabric F100		45.680,00	57.100,00
Fabric F120		48.080,00	60.100,00
Leather L20		50.480,00	63.100,00
Leather L50		67.280,00	84.100,00
Leather L60		79.440,00	99.300,00

Grand Repos & Ottoman	Article no.	without VAT in SEK*	with VAT in SEK*
	210 750 00		
Fabric F60		57.120,00	71.400,00
Fabric F80		58.560,00	73.200,00
Fabric F100		60.880,00	76.100,00
Fabric F120		64.240,00	80.300,00
Leather L20		67.600,00	84.500,00
Leather L50		91.200,00	114.000,00
Leather L60		106.800,00	133.500,00

Grand Repos & Panchina	Article no.	without VAT in SEK*	with VAT in SEK*
W 750 mm	210 751 00		
Fabric F60		51.840,00	64.800,00
Fabric F80		53.040,00	66.300,00
Fabric F100		55.040,00	68.800,00
Fabric F120		58.560,00	73.200,00
Leather L20		60.720,00	75.900,00
Leather L50		80.640,00	100.800,00
Leather L60		94.000,00	117.500,00

Fabric F60	Fabric F80	Fabric F100	Fabric F120	Leather L20	Leather L50	Leather L60
· Valo · Dumet	· Cosy 2 (cross stitch) · Dumet	· Nubia	· Credo	· Leather (contrast seam)	· Leather Premium F (contrast seam)	· Leather Natural F (contrast seam)

Base	Glides	Seat height	Height Ottoman
03 polished aluminium 30 basic dark powder-coated (smooth)	04 glides for carpet 05 felt glides for hard floor	01 low (400 mm) 02 high (450 mm)	01 low (425 mm) 02 high (475 mm)



Ottoman

Antonio Citterio, 2011

vitra.



Panchina 750



Ottoman

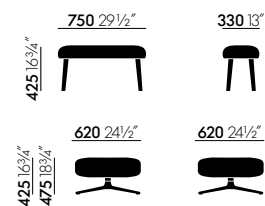

Panchina: plywood board, polyurethane foam and polyester fibre.

Cover: fabric or leather, removable.

Legs: die-cast aluminium, polished or powder-coated finish.

Glides Panchina: only available with plastic glides.

Ottoman: plastic panel, polyurethane foam and polyester fibre.

Cover: fabric or leather, removable.

Four-star base: die-cast aluminium, polished or powder-coated finish.

Glides Ottoman: fitted with plastic glides for soft floors or felt glides for hard floors.

Ottoman

	Article no.	without VAT in SEK*	with VAT in SEK*
	210 752 00		
Fabric F60		14.240,00	17.800,00
Fabric F80		14.720,00	18.400,00
Fabric F100		15.200,00	19.000,00
Fabric F120		16.160,00	20.200,00
Leather L20		17.120,00	21.400,00
Leather L50		23.920,00	29.900,00
Leather L60		27.360,00	34.200,00

Panchina

	Article no.	without VAT in SEK*	with VAT in SEK*
	210 753 00		
Fabric F60		8.960,00	11.200,00
Fabric F80		9.200,00	11.500,00
Fabric F100		9.360,00	11.700,00
Fabric F120		10.480,00	13.100,00
Leather L20		10.240,00	12.800,00
Leather L50		13.360,00	16.700,00
Leather L60		14.560,00	18.200,00

Fabric F60	Fabric F80	Fabric F100	Fabric F120	Leather L20	Leather L50	Leather L60
. Volo	. Cosy 2 (cross stitch) . Dumet	. Nubia	. Credo	. Leather (contrast seam)	. Leather Premium F (contrast seam)	. Leather Natural F (contrast seam)

Base	Glides	Seat height	Height Ottoman
03 polished aluminium	04 glides for carpet	01 low (400 mm)	01 low (425 mm)
30 basic dark powder-coated (smooth)	05 felt glides for hard floor	02 high (450 mm)	02 high (475 mm)

Petit Repos

Antonio Citterio, 2013

vitra.



Chair/body: moulded polyurethane foam with plastic frame.

Seat heights: 405 mm (330 mm with applied load, measured in accordance with EN 1335-1:2000) or 445 mm (370 mm with applied load, measured in accordance with EN 1335-1:2000).

Base: four-star swivel base in die-cast aluminium, polished or powder-coated finish.

Petit Repos	Article no.	without VAT in SEK*	with VAT in SEK*
	210 425 00		
Fabric F60		24.160,00	30.200,00
Fabric F80		24.720,00	30.900,00
Fabric F100		25.760,00	32.200,00
Fabric F120		26.720,00	33.400,00
Leather L20		27.920,00	34.900,00
Leather L50		37.680,00	47.100,00
Leather L60		43.760,00	54.700,00

Fabric F60	Fabric F80	Fabric F100	Fabric F120	Leather L20	Leather L50	Leather L60
. Volo . Dumet	. Cosy 2 (cross stitch) . Dumet	. Nubia	. Credo	. Leather (contrast seam)	. Leather Premium F (contrast seam)	. Leather Natural F (contrast seam)
Base	Glides		Seat height			
03 polished aluminium 30 basic dark powder-coated (smooth)	04 glides for carpet 05 felt glides for hard floor	01 low (400 mm) 02 high (450 mm)				

Slow Chair & Ottoman

Ronan & Erwan Bouroullec, 2006



Slow Chair

Ottoman

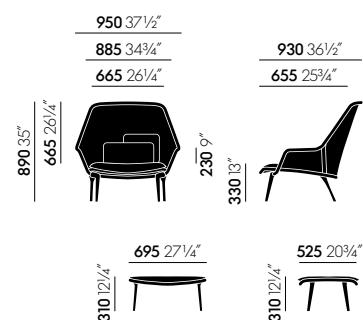

Frame/Cover: tubular steel frame with extremely strong, precisely shaped knitted fabric which is stretched over the frame.

Upholstery: polyurethane foam and polyester fibre, including a seat cushion and two backrest cushions.

Seat height: 330 mm (230 mm with applied load, measured in accordance with EN 1335-1).

Base: die-cast aluminium legs with polished or powder-coated finish.

Glides: all legs fitted with hard glides for carpet; felt glides optionally available for hard floors.

Applications: recommended for home use only.

Slow Chair

	Article no.	without VAT in SEK*	with VAT in SEK*
	210 223 00		
Base chocolate powder-coated	2	29.280,00	36.600,00
Base polished	1	30.080,00	37.600,00

Slow Chair Ottoman

	Article no.	without VAT in SEK*	with VAT in SEK*
	210 242 00		
Base chocolate powder-coated	2	12.800,00	16.000,00
Base polished	1	14.240,00	17.800,00

Slow Chair & Ottoman

	Article no.	without VAT in SEK*	with VAT in SEK*
	210 245 00		
Base chocolate powder-coated	2	42.080,00	52.600,00
Base polished	1	44.320,00	55.400,00

Note: you will find an overview of the colour and fabric combinations for the different sofa versions in the appendix entitled 'Cover materials'.

Slow Chair - black	Slow Chair - blue/green	Slow Chair - brown	Slow Chair - brown/cream	Slow Chair - red/cream	Glides
Tricot - black Intreccio - anthracite Tonus - moss-green Laser - black	Tricot - blue/green Twill - ink blue Laser - dark blue/forest Hopsak - nero/forest	Tricot - brown Intreccio - anthracite Tonus - moss-green Aura - blackberry	Tricot - brown/cream Panamone - dark brown Panamone - moss grey Laser - green	Tricot - red/cream Tonus - moss green Coda - cream Laser - green	04 glides for carpet 05 felt glides for hard floor



Sofas



Abalon Sofa
R & E Bouroullec
257



Alcove Sofa
R & E Bouroullec
260



Alcove Cabin
R & E Bouroullec
272



Alcove Work
R & E Bouroullec
279



Alcove Plus Sofa
R & E Bouroullec
283



Alcove Plus Work
R & E Bouroullec
285



Alcove Plus Desk
R & E Bouroullec
288



Alcove Plus Paravent
R & E Bouroullec
296



Grand Sofà
Antonio Citterio
297



Freeform Sofa
Isamu Noguchi
308



Mariposa Sofa
Barber & Osgerby
310



Polder
Hella Jongerius
313



Soft Modular Sofa
Jasper Morrison
315



Suita Sofa Classic
Antonio Citterio
324



Suita Sofa pointed cushions
Antonio Citterio
333



Suita Sofa tufted
Antonio Citterio
344



Suita Daybed
Antonio Citterio
351



Suita Club Sofa
Antonio Citterio
355



Vlinder Sofa
Hella Jongerius
357

Other products in this chapter



Mariposa Club Armchair
Barber & Osgerby
309



Suita Club Armchair
Antonio Citterio
356



Sofa Tray
Antonio Citterio
307



Suita cushions
Antonio Citterio
352

Office and conference chairs (swivel)

Chairs

Tables

Desks

Public waiting areas

Lounge chairs and armchairs

Sofas



Coffee and side tables

Stools and benches

Storage and partition elements

Accessories

Living, dining, decorative objects, home office,
clocks, lighting, publications

Quick Ship programme

General terms, conditions
and information

Abalon

Ronan & Erwan Bouroullec, 2022

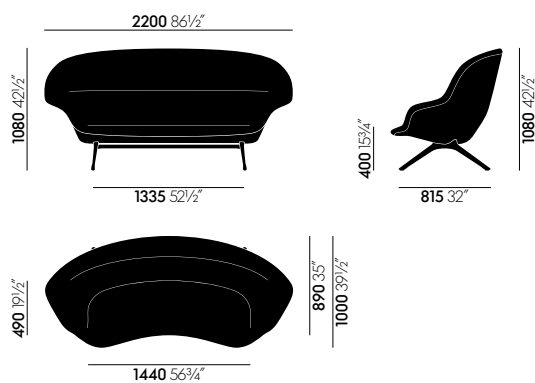

Abalon Sofa



Abalon Platform

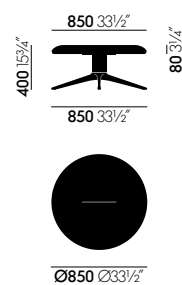

Abalon Table

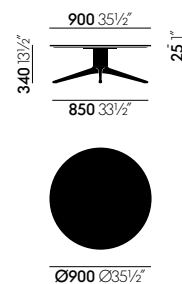

All measurements are pursuant to EN 1335-1:2000
More detailed information is found in the chapter 'Explanation of measurements'.

Abalon

Ronan & Erwan Bouroullec, 2022

Abalon Sofa

Body: metal frame with moulded polyurethane foam and polyester fleece.

Seat height: 400 mm (340 mm with applied load, measured in accordance with EN 1335-1).

Covers: knit fabric, removable. Front and back covers are separate and in different colours.

Legs: die-cast aluminium, powder-coated.

Beam: rectangular tubular steel, powder-coated.

Glides: non-slip plastic glides, suitable for soft and hard floors.

Abalon Platform

Seat surface: plywood panel with moulded polyurethane foam and polyester fleece.

Seat height: 400 mm (340 mm with applied load, measured in accordance with EN 1335-1).

Cover: knit fabric, removable.

Base: non-swivel four-star base in die-cast aluminium, powder-coated finish, pedestal in steel, powder-coated finish.

Glides: plastic glides for soft floors or felt glides for hard floors.

Abalon Table

Table top: base material MDF (medium-density fibreboard) in real oak veneer or textured powder-coated finish; table thickness 25 mm with 15° bevelled edge.

Base: non-swivel four-star base in die-cast aluminium, powder-coated finish, pedestal in steel, powder-coated finish.

Glides: plastic glides for soft floors or felt glides for hard floors.

Planum	Drop	Base	Glides (Platform and Table)
01 silver grey (111)	01 dark green/green (961)	12 deep black powder-coated (smooth)	04 glides for carpet
02 dark green (971)	02 dark green/ochre (951)	91 mint powder-coated (smooth)	05 felt glides for hard floor
03 black (1191)	03 dark green/grey (971)		
	04 dark red/red (691)		
	05 dark red/mauve (671)		
	06 light grey/cream (121)		
	07 dark grey/mauve (261)		
	08 mauve/beige (221)		
	09 beige/cream (101)		
	10 black/dark grey (191)		

Abalon

Ronan & Erwan Bouroullec, 2022

vitra.

Abalon Sofa	Article no.	without VAT in SEK*	with VAT in SEK*
	210 740 00		
Front in Drop / back in Planum		58.640,00	73.300,00

Abalon Platform	Article no.	without VAT in SEK*	with VAT in SEK*
	210 742 00		
Drop		15.760,00	19.700,00

Abalon Table	Article no.	without VAT in SEK*	with VAT in SEK*
	210 743 00		
MDF powder-coated in soft light	B1S52	10.720,00	13.400,00
MDF powder-coated in basic dark	B1S30	10.720,00	13.400,00
light oak	C1S17	17.200,00	21.500,00
dark oak	C1S04	17.200,00	21.500,00

Planum	Drop	Base	Glides (Platform and Table)
01 silver grey (111)	01 dark green/green (961)	12 deep black powder-coated (smooth)	04 glides for carpet
02 dark green (971)	02 dark green/ochre (951)	91 mint powder-coated (smooth)	05 felt glides for hard floor
03 black (1191)	03 dark green/grey (971)		
	04 dark red/red (691)		
	05 dark red/mauve (671)		
	06 light grey/cream (121)		
	07 dark grey/mauve (261)		
	08 mauve/beige (221)		
	09 beige/cream (101)		
	10 black/dark grey (191)		



Alcove Sofa

Ronan & Erwan Bouroullec, 2006/2021

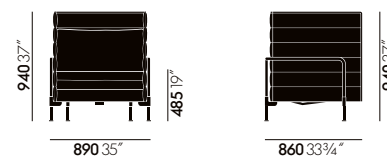

Alcove Fauteuil Lowback (Lounge upholstery)

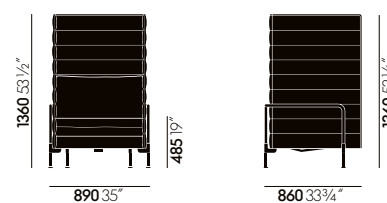

Alcove Fauteuil Highback (Lounge upholstery)

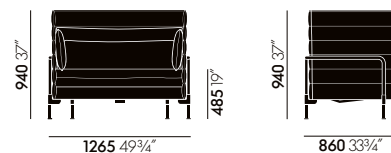

Alcove Love Seat Lowback (Lounge upholstery, with cushion set)

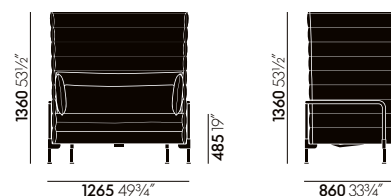

Alcove Love Seat Highback (Work upholstery, with cushion set)

All measurements are pursuant to EN 1335-1:2000
 More detailed information is found in the chapter 'Explanation of measurements'.

Alcove Sofa

Ronan & Erwan Bouroullec, 2006/2021

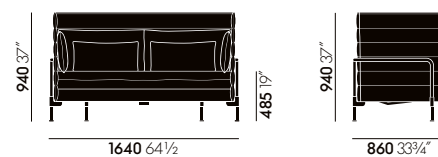

Alcove 2-Seater Lowback (Lounge upholstery, with cushion set)

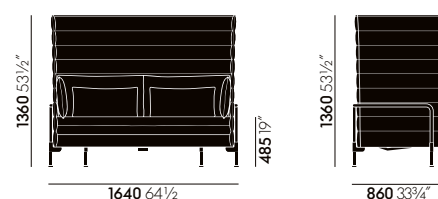

Alcove 2-Seater Highback (Lounge upholstery, with cushion set)

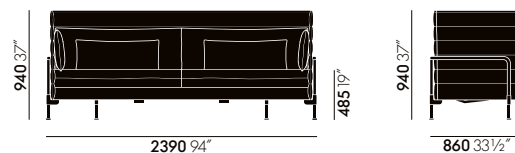

Alcove 3-Seater Lowback (Lounge upholstery, with cushion set)

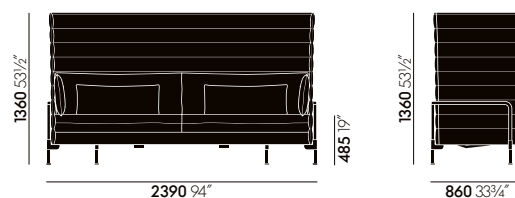

Alcove 3-Seater Highback (Lounge upholstery, with cushion set)

All measurements are pursuant to EN 1335-1:2000
 More detailed information is found in the chapter 'Explanation of measurements'.

Alcove Sofa

Ronan & Erwan Bouroullec, 2006/2021

Body: back and side panels with organic fibreboard core, connected with zip fasteners. Quilted cover with polyester-fibre padding.

Frame: tubular steel with chrome-plated finish or powder-coated (smooth).

Legs: steel, chrome-plated or powder-coated (smooth). Felt glides. Optionally equipped with lockable castors, in black plastic, soft version for protection of hard floors.

Upholstery: Alcove Sofas come in two different upholstery versions: soft ‚Lounge‘ upholstery for relaxed sitting and firmer ‚Work‘ upholstery for work-oriented sitting.

Lounge Upholstery

Structural frame: metal frame with upholstery webbing.

Seat cushion: polyurethane foam and polyester fibre.

Seat height: 485 mm (325 mm with applied load, measured in accordance with EN 1335-1:2000).

Back cushions and optional cushion set: polyurethane chips and microfibre filling.

Alcove Fauteuil and Love Seat: incl. 1 back cushion.

Alcove 2-Seater and 3-Seater: incl. 2 back cushions.

Optional cushion set for Love Seat: 2 armrest cushions (600 x 400 mm) and 1 back cushion (710 x 220 mm).

Optional cushion set for 2-Seater: 2 armrest cushions (600 x 400 mm) and 2 back cushions (420 x 220 mm).

Optional cushion set for 3-Seater: 2 armrest cushions (600 x 400 mm) and 2 back cushions (710 x 220 mm).

Covers: removable.

Work upholstery

Structural frame: metal frame with MDF base board.

Seat/back cushions: polyurethane foam and polyester fibre.

Seat height: 480 mm (385 mm with applied load, measured in accordance with EN 1335-1:2000).

Covers: removable.

Alcove Sofa

Ronan & Erwan Bouroullec, 2006/2021

vitra.

Alcove Fauteuil Lowback	Article no.	without VAT in SEK*	with VAT in SEK*
Work upholstery	210 660 00		
Fabric F40		39.520,00	49.400,00
Fabric F60		42.000,00	52.500,00
Fabric F80		44.720,00	55.900,00
Fabric F120		50.480,00	63.100,00
Surcharges base			
glides	01	0,00	0,00
castors	02	944,00	1.180,00
Surcharges tubular steel frame			
Colour group 1		0,00	0,00
Colour group 2		656,00	820,00
Lounge upholstery	210 661 00		
Fabric F40		43.600,00	54.500,00
Fabric F60		46.400,00	58.000,00
Fabric F80		49.280,00	61.600,00
Fabric F120		55.120,00	68.900,00
Surcharges base			
glides	01	0,00	0,00
castors	02	944,00	1.180,00
Surcharges tubular steel frame			
Colour group 1		0,00	0,00
Colour group 2		656,00	820,00



Fabric F40	Fabric F60	Fabric F80	Fabric F120	Tubular steel frame group 1	Tubular steel frame group 2
. Laser RE	. Volo	. Cosy 2 . Tress	. Credo . Track	01 chrome 12 deep black powder-coated (smooth)	06 Japanese red powder-coated (smooth) 32 dark grey powder-coated (smooth) 52 soft light powder-coated (smooth) 91 mint powder-coated (smooth)

Alcove Sofa

Ronan & Erwan Bouroullec, 2006/2021

vitra.

Alcove Fauteuil Highback	Article no.	without VAT in SEK*	with VAT in SEK*
Work upholstery	210 662 00		
Fabric F40		41.280,00	51.600,00
Fabric F60		43.760,00	54.700,00
Fabric F80		46.640,00	58.300,00
Fabric F120		52.320,00	65.400,00
Surcharges base			
glides	01	0,00	0,00
castors	02	944,00	1.180,00
Surcharges tubular steel frame			
Colour group 1		0,00	0,00
Colour group 2		656,00	820,00
Lounge upholstery	210 663 00		
Fabric F40		46.000,00	57.500,00
Fabric F60		48.560,00	60.700,00
Fabric F80		51.520,00	64.400,00
Fabric F120		57.440,00	71.800,00
Surcharges base			
glides	01	0,00	0,00
castors	02	944,00	1.180,00
Surcharges tubular steel frame			
Colour group 1		0,00	0,00
Colour group 2		656,00	820,00

Fabric F40	Fabric F60	Fabric F80	Fabric F120	Tubular steel frame group 1	Tubular steel frame group 2
. Laser RE	. Volo	. Cosy 2 . Tress	. Credo . Track	01 chrome 12 deep black powder-coated (smooth)	06 Japanese red powder-coated (smooth) 32 dark grey powder-coated (smooth) 52 soft light powder-coated (smooth) 91 mint powder-coated (smooth)

Alcove Sofa

Ronan & Erwan Bouroullec, 2006/2021

vitra.

Alcove Love Seat Lowback		Article no.	without VAT in SEK*	with VAT in SEK*
Work upholstery		210 664 00		
Fabric F40			48.480,00	60.600,00
Fabric F60			51.360,00	64.200,00
Fabric F80			54.640,00	68.300,00
Fabric F120			61.520,00	76.900,00
Surcharges base				
glides		01	0,00	0,00
castors		02	944,00	1.180,00
Surcharges tubular steel frame				
Colour group 1			0,00	0,00
Colour group 2			656,00	820,00
Lounge upholstery		210 665 00		
Fabric F40			53.280,00	66.600,00
Fabric F60			56.400,00	70.500,00
Fabric F80			59.680,00	74.600,00
Fabric F120			66.640,00	83.300,00
Surcharges base				
glides		01	0,00	0,00
castors		02	944,00	1.180,00
Surcharges tubular steel frame				
Colour group 1			0,00	0,00
Colour group 2			656,00	820,00



Fabric F40	Fabric F60	Fabric F80	Fabric F120	Tubular steel frame group 1	Tubular steel frame group 2
. Laser RE	. Volo	. Cosy 2 . Tress	. Credo . Track	01 chrome 12 deep black powder-coated (smooth)	06 Japanese red powder-coated (smooth) 32 dark grey powder-coated (smooth) 52 soft light powder-coated (smooth) 91 mint powder-coated (smooth)

Alcove Sofa

Ronan & Erwan Bouroullec, 2006/2021

vitra.

Alcove Love Seat Highback		Article no.	without VAT in SEK*	with VAT in SEK*
Work upholstery		210 666 00		
Fabric F40			58.560,00	73.200,00
Fabric F60			61.440,00	76.800,00
Fabric F80			64.720,00	80.900,00
Fabric F120			71.520,00	89.400,00
Surcharges base				
glides		01	0,00	0,00
castors		02	944,00	1.180,00
Surcharges tubular steel frame				
Colour group 1			0,00	0,00
Colour group 2			656,00	820,00
Lounge upholstery		210 667 00		
Fabric F40			64.720,00	80.900,00
Fabric F60			67.600,00	84.500,00
Fabric F80			71.040,00	88.800,00
Fabric F120			78.080,00	97.600,00
Surcharges base				
glides		01	0,00	0,00
castors		02	944,00	1.180,00
Surcharges tubular steel frame				
Colour group 1			0,00	0,00
Colour group 2			656,00	820,00

Fabric F40	Fabric F60	Fabric F80	Fabric F120	Tubular steel frame group 1	Tubular steel frame group 2
. Laser RE	. Volo	. Cosy 2 . Tress	. Credo . Track	01 chrome 12 deep black powder-coated (smooth)	06 Japanese red powder-coated (smooth) 32 dark grey powder-coated (smooth) 52 soft light powder-coated (smooth) 91 mint powder-coated (smooth)

Alcove Sofa

Ronan & Erwan Bouroullec, 2006/2021

vitra.

Alcove 2-Seater Lowback		Article no.	without VAT in SEK*	with VAT in SEK*
Work upholstery		210 669 00		
Fabric F40			60.000,00	75.000,00
Fabric F60			63.520,00	79.400,00
Fabric F80			67.360,00	84.200,00
Fabric F120			75.360,00	94.200,00
Surcharges base				
glides		01	0,00	0,00
castors		02	944,00	1.180,00
Surcharges tubular steel frame				
Colour group 1			0,00	0,00
Colour group 2			656,00	820,00
Lounge upholstery		210 670 00		
Fabric F40			67.200,00	84.000,00
Fabric F60			70.800,00	88.500,00
Fabric F80			74.560,00	93.200,00
Fabric F120			83.040,00	103.800,00
Surcharges base				
glides		01	0,00	0,00
castors		02	944,00	1.180,00
Surcharges tubular steel frame				
Colour group 1			0,00	0,00
Colour group 2			656,00	820,00

Fabric F40	Fabric F60	Fabric F80	Fabric F120	Tubular steel frame group 1	Tubular steel frame group 2
. Laser RE	. Volo	. Cosy 2 . Tress	. Credo . Track	01 chrome 12 deep black powder-coated (smooth)	06 Japanese red powder-coated (smooth) 32 dark grey powder-coated (smooth) 52 soft light powder-coated (smooth) 91 mint powder-coated (smooth)



Alcove Sofa

Ronan & Erwan Bouroullec, 2006/2021

vitra.

Alcove 2-Seater Highback	Article no.	without VAT in SEK*	with VAT in SEK*
Work upholstery	210 671 00		
Fabric F40		69.600,00	87.000,00
Fabric F60		73.120,00	91.400,00
Fabric F80		76.960,00	96.200,00
Fabric F120		84.880,00	106.100,00
Surcharges base			
glides	01	0,00	0,00
castors	02	944,00	1.180,00
Surcharges tubular steel frame			
Colour group 1		0,00	0,00
Colour group 2		656,00	820,00
Lounge upholstery	210 672 00		
Fabric F40		77.280,00	96.600,00
Fabric F60		80.720,00	100.900,00
Fabric F80		84.800,00	106.000,00
Fabric F120		92.960,00	116.200,00
Surcharges base			
glides	01	0,00	0,00
castors	02	944,00	1.180,00
Surcharges tubular steel frame			
Colour group 1		0,00	0,00
Colour group 2		656,00	820,00

Fabric F40	Fabric F60	Fabric F80	Fabric F120	Tubular steel frame group 1	Tubular steel frame group 2
. Laser RE	. Volo	. Cosy 2 . Tress	. Credo . Track	01 chrome 12 deep black powder-coated (smooth)	06 Japanese red powder-coated (smooth) 32 dark grey powder-coated (smooth) 52 soft light powder-coated (smooth) 91 mint powder-coated (smooth)

Alcove Sofa

Ronan & Erwan Bouroullec, 2006/2021

vitra.

Alcove 3-Seater Lowback		Article no.	without VAT in SEK*	with VAT in SEK*
Work upholstery		210 674 00		
Fabric F40			72.240,00	90.300,00
Fabric F60			76.800,00	96.000,00
Fabric F80			81.840,00	102.300,00
Fabric F120			92.240,00	115.300,00
Surcharges base				
glides		01	0,00	0,00
castors		02	944,00	1.180,00
Surcharges tubular steel frame				
Colour group 1			0,00	0,00
Colour group 2			656,00	820,00
Lounge upholstery		210 675 00		
Fabric F40			80.400,00	100.500,00
Fabric F60			85.040,00	106.300,00
Fabric F80			90.160,00	112.700,00
Fabric F120			100.800,00	126.000,00
Surcharges base				
glides		01	0,00	0,00
castors		02	944,00	1.180,00
Surcharges tubular steel frame				
Colour group 1			0,00	0,00
Colour group 2			656,00	820,00



Fabric F40	Fabric F60	Fabric F80	Fabric F120	Tubular steel frame group 1	Tubular steel frame group 2
. Laser RE	. Volo	. Cosy 2 . Tress	. Credo . Track	01 chrome 12 deep black powder-coated (smooth)	06 Japanese red powder-coated (smooth) 32 dark grey powder-coated (smooth) 52 soft light powder-coated (smooth) 91 mint powder-coated (smooth)

Alcove Sofa

Ronan & Erwan Bouroullec, 2006/2021

vitra.

Alcove 3-Seater Highback

	Article no.	without VAT in SEK*	with VAT in SEK*
Work upholstery	210 676 00		
Fabric F40		87.680,00	109.600,00
Fabric F60		92.160,00	115.200,00
Fabric F80		97.120,00	121.400,00
Fabric F120		107.360,00	134.200,00
Surcharges base			
glides	01	0,00	0,00
castors	02	944,00	1.180,00
Surcharges tubular steel frame			
Colour group 1		0,00	0,00
Colour group 2		656,00	820,00
Lounge upholstery	210 677 00		
Fabric F40		97.360,00	121.700,00
Fabric F60		102.000,00	127.500,00
Fabric F80		107.120,00	133.900,00
Fabric F120		118.000,00	147.500,00
Surcharges base			
glides	01	0,00	0,00
castors	02	944,00	1.180,00
Surcharges tubular steel frame			
Colour group 1		0,00	0,00
Colour group 2		656,00	820,00

Fabric F40	Fabric F60	Fabric F80	Fabric F120	Tubular steel frame group 1	Tubular steel frame group 2
. Laser RE	. Volo	. Cosy 2 . Tress	. Credo . Track	01 chrome 12 deep black powder-coated (smooth)	06 Japanese red powder-coated (smooth) 32 dark grey powder-coated (smooth) 52 soft light powder-coated (smooth) 91 mint powder-coated (smooth)

Alcove Sofa

Ronan & Erwan Bouroullec, 2006/2021

vitra.

Cushion set for Love Seat

	Article no.	without VAT in SEK*	with VAT in SEK*
	210 668 00		
Fabric F40		6.280,00	7.850,00
Fabric F60		6.792,00	8.490,00
Fabric F80		7.280,00	9.100,00
Fabric F120		8.560,00	10.700,00

Cushion set for 2-Seater

	Article no.	without VAT in SEK*	with VAT in SEK*
	210 673 00		
Fabric F40		7.720,00	9.650,00
Fabric F60		8.320,00	10.400,00
Fabric F80		8.960,00	11.200,00
Fabric F120		10.320,00	12.900,00

Cushion set for 3-Seater

	Article no.	without VAT in SEK*	with VAT in SEK*
	210 678 00		
Fabric F40		7.800,00	9.750,00
Fabric F60		8.560,00	10.700,00
Fabric F80		9.440,00	11.800,00
Fabric F120		11.120,00	13.900,00

Fabric F40	Fabric F60	Fabric F80	Fabric F120	Tubular steel frame group 1	Tubular steel frame group 2
. Laser RE	. Volo	. Cosy 2 . Tress	. Credo . Track	01 chrome 12 deep black powder-coated (smooth)	06 Japanese red powder-coated (smooth) 32 dark grey powder-coated (smooth) 52 soft light powder-coated (smooth) 91 mint powder-coated (smooth)

Alcove Cabin

Ronan & Erwan Bouroullec, 2012/2021

vitra.



Alcove Cabin Love Seat Lowback

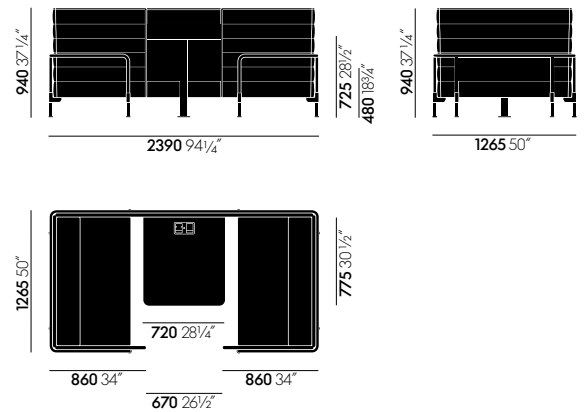

Alcove Cabin Love Seat Highback

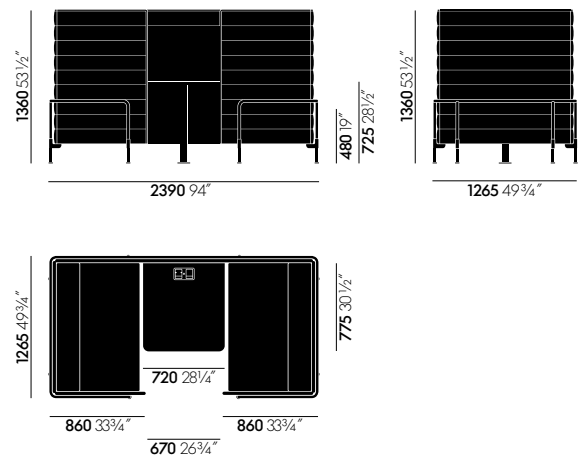

Alcove Cabin 2-Seater Lowback

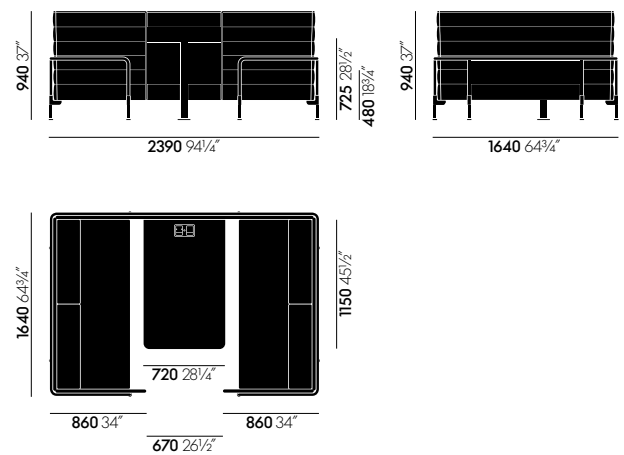

Alcove Cabin

Ronan & Erwan Bouroullec, 2012/2021

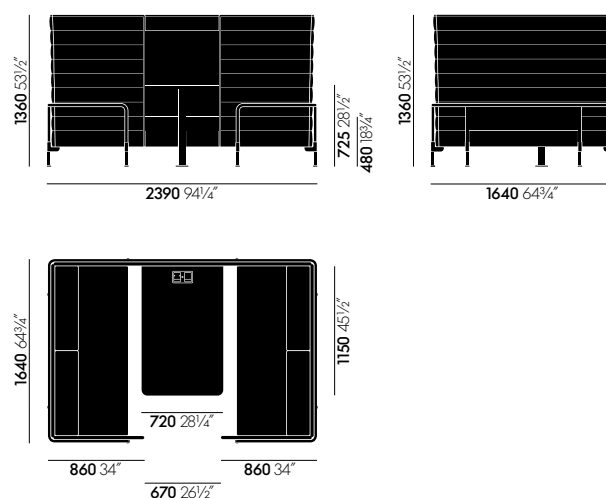

Alcove Cabin 2-Seater Highback

All measurements are pursuant to EN 1335-1:2000
More detailed information is found in the chapter 'Explanation of measurements'.

Structural frame: tubular steel with chrome-plated finish or powder-coated (smooth), metal frame with MDF base board.

Body: back and side panels with organic fibreboard core, connecting panel with organic fibreboard core and metal structure, connected with zip fasteners. Quilted cover with polyester-fibre padding.

Seat/back cushions: polyurethane foam and polyester fibre.

Seat height: 480 mm (385 mm with applied load, measured in accordance with EN 1335-1:2000).

Covers: removable.

Add-on table: thickness 25 mm, high-density three-ply fine particle board with melamine coating and 3-mm ABS edge; or MDF board, powder-coated (textured finish); or oak veneer (sourced in Europe) with straight veneered edge 2.5-3.0 mm. Table legs in tubular steel, chrome-plated or powder-coated (smooth). Additional reinforcement in the connecting panel for secure attachment of the table top to the body.

Table height: 725 mm.

Legs: tubular steel, chrome-plated or powder-coated (smooth). Felt glides. Optionally equipped with lockable castors, in black plastic, soft version for protection of hard floors (only for units without add-on table).

Alcove Cabin

Ronan & Erwan Bouroullec, 2012/2021

vitra.

Alcove Cabin Love Seat Lowback	Article no.	without VAT in SEK*	with VAT in SEK*
Lowback	210 679 00		
Fabric F40		104.640,00	130.800,00
Fabric F60		110.960,00	138.700,00
Fabric F80		118.240,00	147.800,00
Fabric F120		132.960,00	166.200,00
Surcharges base			
glides	01	0,00	0,00
castors (only without add-on table)	02	1.992,00	2.490,00
Surcharges tubular steel frame			
Colour group 1		0,00	0,00
Colour group 2		1.408,00	1.760,00
Surcharges add-on table top 775 x 720 mm			
not included	00000	0,00	0,00
melamine soft light	A1S52	7.560,00	9.450,00
MDF powder-coated in soft light	B1S52	9.280,00	11.600,00
MDF powder-coated in basic dark	B1S30	9.280,00	11.600,00
light oak	C1S17	13.440,00	16.800,00
black oak	C1S50	13.440,00	16.800,00
Surcharges table top electrification			
not included	00	0,00	0,00
Port 180, frame and cover in soft light	5252	3.112,00	3.890,00
Port 180, frame and cover in basic dark	3030	3.112,00	3.890,00
Port 180, frame polished / cover in basic dark	0330	3.400,00	4.250,00
Surcharges equipment for Port 180			
not included	00	0,00	0,00
1x power	01	1.880,00	2.350,00
2x power	02	3.600,00	4.500,00
1x power + 1x USB charger A-C	13	5.920,00	7.400,00
1x power + 1x USB charger C	16	5.640,00	7.050,00

Fabric F40	Fabric F60	Fabric F80	Fabric F120	Tubular steel frame group 1	Tubular steel frame group 2
. Laser RE	. Volo	. Cosy 2 . Tress	. Credo . Track	01 chrome 12 deep black powder-coated (smooth)	06 Japanese red powder-coated (smooth) 32 dark grey powder-coated (smooth) 52 soft light powder-coated (smooth) 91 mint powder-coated (smooth)

Alcove Cabin

Ronan & Erwan Bouroullec, 2012/2021

vitra.

Alcove Cabin Love Seat Highback

	Article no.	without VAT in SEK*	with VAT in SEK*
Highback	210 680 00		
Fabric F40		119.280,00	149.100,00
Fabric F60		125.760,00	157.200,00
Fabric F80		132.880,00	166.100,00
Fabric F120		147.760,00	184.700,00
Surcharges base			
glides	01	0,00	0,00
castors (only without add-on table)	02	1.992,00	2.490,00
Surcharges tubular steel frame			
Colour group 1		0,00	0,00
Colour group 2		1.408,00	1.760,00
Surcharges add-on table top 775 x 720 mm			
not included	00000	0,00	0,00
melamine soft light	A1S52	7.560,00	9.450,00
MDF powder-coated in soft light	B1S52	9.280,00	11.600,00
MDF powder-coated in basic dark	B1S30	9.280,00	11.600,00
light oak	C1S17	13.440,00	16.800,00
black oak	C1S50	13.440,00	16.800,00
Surcharges table top electrification			
not included	00	0,00	0,00
Port 180, frame and cover in soft light	5252	3.112,00	3.890,00
Port 180, frame and cover in basic dark	3030	3.112,00	3.890,00
Port 180, frame polished / cover in basic dark	0330	3.400,00	4.250,00
Surcharges equipment for Port 180			
not included	00	0,00	0,00
1x power	01	1.880,00	2.350,00
2x power	02	3.600,00	4.500,00
1x power + 1x USB charger A-C	13	5.920,00	7.400,00
1x power + 1x USB charger C	16	5.640,00	7.050,00
Surcharges screen integration on panel**			
without screen integration	00	0,00	0,00
reinforced panel including VESA mounting***	01	5.272,00	6.590,00

** only possible with Port 180 with "1x Power"

*** Mount according to VESA standard up to 200 x 200.

Maximum screen size 37 inches, maximum weight 18 kg.

Fabric F40	Fabric F60	Fabric F80	Fabric F120	Tubular steel frame group 1	Tubular steel frame group 2
. Laser RE	. Volo	. Cosy 2 . Tress	. Credo . Track	01 chrome 12 deep black powder-coated (smooth)	06 Japanese red powder-coated (smooth) 32 dark grey powder-coated (smooth) 52 soft light powder-coated (smooth) 91 mint powder-coated (smooth)

Alcove Cabin

Ronan & Erwan Bouroullec, 2012/2021

vitra.

Alcove Cabin 2-Seater Lowback	Article no.	without VAT in SEK*	with VAT in SEK*
Lowback	210 681 00		
Fabric F40		123.120,00	153.900,00
Fabric F60		130.400,00	163.000,00
Fabric F80		138.480,00	173.100,00
Fabric F120		155.200,00	194.000,00
Surcharges base			
glides	01	0,00	0,00
castors (only without add-on table)	02	1.992,00	2.490,00
Surcharges tubular steel frame			
Colour group 1		0,00	0,00
Colour group 2		1.408,00	1.760,00
Surcharges add-on table top 1150x720 mm			
not included	00000	0,00	0,00
melamine soft light	A1S52	8.080,00	10.100,00
MDF powder-coated in soft light	B1S52	10.000,00	12.500,00
MDF powder-coated in basic dark	B1S30	10.000,00	12.500,00
light oak	C1S17	14.400,00	18.000,00
black oak	C1S50	14.400,00	18.000,00
Surcharges table top electrification			
not included	00000	0,00	0,00
Port 180, frame and cover in soft light	5252	3.112,00	3.890,00
Port 180, frame and cover in basic dark	3030	3.112,00	3.890,00
Port 180, frame polished / cover in basic dark	0330	3.400,00	4.250,00
Surcharges equipment for Port 180			
not included	00	0,00	0,00
1x power	01	1.880,00	2.350,00
2x power	02	3.600,00	4.500,00
1x power + 1x USB charger A-C	13	5.920,00	7.400,00
1x power + 1x USB charger C	16	5.640,00	7.050,00

Fabric F40	Fabric F60	Fabric F80	Fabric F120	Tubular steel frame group 1	Tubular steel frame group 2
. Laser RE	. Volo	. Cosy 2 . Tress	. Credo . Track	01 chrome 12 deep black powder-coated (smooth)	06 Japanese red powder-coated (smooth) 32 dark grey powder-coated (smooth) 52 soft light powder-coated (smooth) 91 mint powder-coated (smooth)

Alcove Cabin

Ronan & Erwan Bouroullec, 2012/2021

vitra.

Alcove Cabin 2-Seater Highback	Article no.	without VAT in SEK*	with VAT in SEK*
Highback	210 682 00		
Fabric F40		141.200,00	176.500,00
Fabric F60		148.560,00	185.700,00
Fabric F80		156.640,00	195.800,00
Fabric F120		173.360,00	216.700,00
Surcharges base			
glides	01	0,00	0,00
castors (only without add-on table)	02	1.992,00	2.490,00
Surcharges tubular steel frame			
Colour group 1		0,00	0,00
Colour group 2		1.408,00	1.760,00
Surcharges add-on table top 1150 x 720 mm			
not included	00000	0,00	0,00
melamine soft light	A1S52	8.080,00	10.100,00
MDF powder-coated in soft light	B1S52	10.000,00	12.500,00
MDF powder-coated in basic dark	B1S30	10.000,00	12.500,00
light oak	C1S17	14.400,00	18.000,00
black oak	C1S50	14.400,00	18.000,00
Surcharges table top electrification			
not included	00000	0,00	0,00
Port 180, frame and cover in soft light	5252	3.112,00	3.890,00
Port 180, frame and cover in basic dark	3030	3.112,00	3.890,00
Port 180, frame polished / cover in basic dark	0330	3.400,00	4.250,00
Surcharges equipment for Port 180			
not included	00	0,00	0,00
1x power	01	1.880,00	2.350,00
2x power	02	3.600,00	4.500,00
1x power + 1x USB charger A-C	13	5.920,00	7.400,00
1x power + 1x USB charger C	16	5.640,00	7.050,00
Surcharges screen integration on panel**			
without screen integration	00	0,00	0,00
reinforced panel including VESA mounting***	01	5.272,00	6.590,00

** only possible with Port 180 with "1x Power"

*** Mount according to VESA standard up to 200 x 200.

Maximum screen size 37 inches, maximum weight 18 kg.

Fabric F40	Fabric F60	Fabric F80	Fabric F120	Tubular steel frame group 1	Tubular steel frame group 2
. Laser RE	. Volo	. Cosy 2 . Tress	. Credo . Track	01 chrome 12 deep black powder-coated (smooth)	06 Japanese red powder-coated (smooth) 32 dark grey powder-coated (smooth) 52 soft light powder-coated (smooth) 91 mint powder-coated (smooth)

Alcove Cabin

Ronan & Erwan Bouroullec, 2012/2021

vitra.

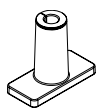

For attaching table lamps to port cable outlet; inner diameter: 10 mm; including reduction sleeve and assembly materials, excl. lamp.

Lamp adapter for port

	Article no.	without VAT in SEK*	with VAT in SEK*
aluminium powder-coated in soft light	853 466 11	752,00	940,00
polished aluminium	853 466 12	856,00	1.070,00



Including 4 zip fasteners

Cable net long

		Article no.	without VAT in SEK*	with VAT in SEK*
W 30 x L 1500 mm	polyester basic dark	833 040 02	560,00	700,00
W 30 x L 1500 mm	polyester grey	833 040 12	560,00	700,00

Alcove Work

Ronan & Erwan Bouroullec, 2010/2021



Alcove Work Lowback

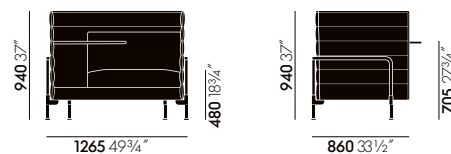

Alcove Work Lowback, tablet desk on left

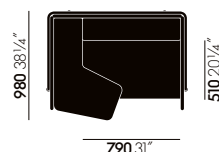

Alcove Work Highback

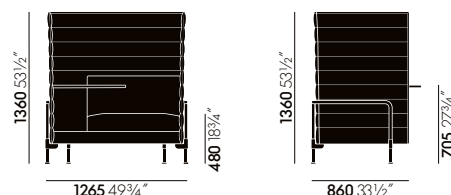

Alcove Work Highback, tablet desk on left

All measurements are pursuant to EN 1335-1:2000
More detailed information is found in the chapter 'Explanation of measurements'.

Structural frame: tubular steel with chrome-plated finish or powder-coated (smooth), metal frame with MDF base board.

Body: back and side panels with organic fibreboard core, connected with zip fasteners. Quilted cover with polyester-fibre padding.

Seat/back cushions: polyurethane foam and polyester fibre.

Seat height: 480 mm (385 mm with applied load, measured in accordance with EN 1335-1:2000).

Box: wooden carcass covered in polyurethane foam.

Tablet desk: thickness 25 mm, high-density three-ply fine particle board with melamine coating and 3-mm ABS edge; or MDF board, powder-coated (textured finish); or in oak veneer (sourced in Europe) with straight veneered edge 2.5-3.0 mm.

Covers: removable.

Legs: steel, chrome-plated or powder-coated (smooth). Felt glides. Optionally equipped with lockable castors, in black plastic, soft version for protection of hard floors (only for units without electrification).

Alcove Work

Ronan & Erwan Bouroullec, 2010/2021

vitra.

Alcove Work Lowback	Article no.	without VAT in SEK*	with VAT in SEK*
Lowback	210 683 00		
Fabric F40		56.000,00	70.000,00
Fabric F60		58.960,00	73.700,00
Fabric F80		62.240,00	77.800,00
Fabric F120		69.360,00	86.700,00
Surcharges base			
glides	01	0,00	0,00
castors	02	944,00	1.180,00
Surcharges tubular steel frame			
Colour group 1		0,00	0,00
Colour group 2		656,00	820,00
Surcharges tray			
melamine soft light	A1S52	0,00	0,00
MDF powder-coated in soft light	B1S52	2.552,00	3.190,00
MDF powder-coated basic dark	B1S30	2.552,00	3.190,00
light oak	C1S17	5.080,00	6.350,00
black oak	C1S50	5.080,00	6.350,00
Surcharges tray electrification			
not included	00	0,00	0,00
Punto wireless charging (including USB cable and power supply)	01	5.400,00	6.750,00
Port 120, frame and cover in soft light	5252	1.760,00	2.200,00
Port 120, frame and cover in basic dark	3030	1.760,00	2.200,00
Port 120, frame polished / cover in basic dark	0330	2.072,00	2.590,00
Surcharges equipment for Port 120			
not included	00	0,00	0,00
1x power	01	1.880,00	2.350,00
1x USB charger A-C	12	4.680,00	5.850,00
1x USB charger C	15	4.400,00	5.500,00

Fabric F40	Fabric F60	Fabric F80	Fabric F120
. Laser RE	. Volo	. Cosy 2 . Tress	. Credo . Track

Tubular steel frame group 1	Tubular steel frame group 2	Placement of box
01 chrome	06 Japanese red powder-coated (smooth)	01/R Armrest right/sitting left
12 deep black powder-coated (smooth)	32 dark grey powder-coated (smooth)	02/L Armrest left/sitting right
	52 soft light powder-coated (smooth)	
	91 mint powder-coated (smooth)	

Alcove Work

Ronan & Erwan Bouroullec, 2010/2021

vitra.

Alcove Work Highback

	Article no.	without VAT in SEK*	with VAT in SEK*
Highback	210 684 00		
Fabric F40		63.920,00	79.900,00
Fabric F60		66.960,00	83.700,00
Fabric F80		70.320,00	87.900,00
Fabric F120		77.280,00	96.600,00
Surcharges base			
glides	01	0,00	0,00
castors	02	944,00	1.180,00
Surcharges tubular steel frame			
Colour group 1		0,00	0,00
Colour group 2		656,00	820,00
Surcharges tray			
melamine soft light	A1S52	0,00	0,00
MDF powder-coated in soft light	B1S52	2.552,00	3.190,00
MDF powder-coated basic dark	B1S30	2.552,00	3.190,00
light oak	C1S17	5.080,00	6.350,00
black oak	C1S50	5.080,00	6.350,00
Surcharges tray electrification			
not included	00	0,00	0,00
Punto wireless charging (including USB cable and power supply)	01	5.400,00	6.750,00
Port 120, frame and cover in soft light	5252	1.760,00	2.200,00
Port 120, frame and cover in basic dark	3030	1.760,00	2.200,00
Port 120, frame polished / cover in basic dark	0330	2.072,00	2.590,00
Surcharges equipment for Port 120			
not included	00	0,00	0,00
1x power	01	1.880,00	2.350,00
1x USB charger A-C	12	4.680,00	5.850,00
1x USB charger C	15	4.400,00	5.500,00

Fabric F40	Fabric F60	Fabric F80	Fabric F120
. Laser RE	. Volo	. Cosy 2 . Tress	. Credo . Track

Tubular steel frame group 1	Tubular steel frame group 2	Placement of box
01 chrome	06 Japanese red powder-coated (smooth)	01/R Armrest right/sitting left
12 deep black powder-coated (smooth)	32 dark grey powder-coated (smooth)	02/L Armrest left/sitting right
	52 soft light powder-coated (smooth)	
	91 mint powder-coated (smooth)	

Alcove Work

Ronan & Erwan Bouroullec, 2010/2021

vitra.

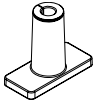

For attaching table lamps to port cable outlet; inner diameter: 10 mm; including reduction sleeve and assembly materials, excl. lamp.

Lamp adapter for port

	Article no.	without VAT in SEK*	with VAT in SEK*
aluminium powder-coated in soft light	853 466 11	752,00	940,00
polished aluminium	853 466 12	856,00	1.070,00



Including 4 zip fasteners

Cable net long

		Article no.	without VAT in SEK*	with VAT in SEK*
W 30 x L 1500 mm	polyester basic dark	833 040 02	560,00	700,00
W 30 x L 1500 mm	polyester grey	833 040 12	560,00	700,00

Alcove Plus Sofa

Ronan & Erwan Bouroullec, 2021

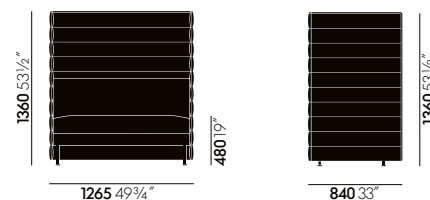

Alcove Plus Love Seat

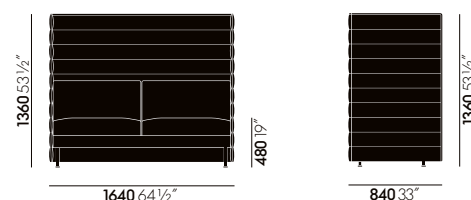

Alcove Plus 2-Seater

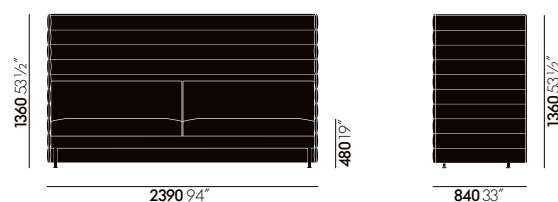

Alcove Plus 3-Seater

All measurements are pursuant to EN 1335-1:2000
More detailed information is found in the chapter 'Explanation of measurements'.

Structural frame: metal frame with MDF base board.

Body: back and side panels with organic fibreboard core, connected with zip fasteners. Quilted cover with polyester-fibre padding. A zip fastener along the front edge of the side panels allows for attachment to the optional Alcove Plus Paravent.

Seat/back cushions: polyurethane foam and polyester fibre.

Seat height: 480 mm (385 mm with applied load, measured in accordance with EN 1335-1:2000).

Covers: removable.

Legs: steel, chrome-plated or powder-coated (smooth). Felt glides.

Alcove Plus Sofa

Ronan & Erwan Bouroullec, 2021

vitra.

Alcove Plus Love Seat	Article no.	without VAT in SEK*	with VAT in SEK*
	210 685 00		
Fabric F40		58.560,00	73.200,00
Fabric F60		61.920,00	77.400,00
Fabric F80		65.840,00	82.300,00
Fabric F120		73.760,00	92.200,00
Surcharge Base			
Colour group 1		0,00	0,00
Colour group 2		376,00	470,00

Alcove Plus 2-Seater	Article no.	without VAT in SEK*	with VAT in SEK*
	210 686 00		
Fabric F40		69.600,00	87.000,00
Fabric F60		73.760,00	92.200,00
Fabric F80		78.320,00	97.900,00
Fabric F120		87.840,00	109.800,00
Surcharge Base			
Colour group 1		0,00	0,00
Colour group 2		376,00	470,00

Alcove Plus 3-Seater	Article no.	without VAT in SEK*	with VAT in SEK*
	210 687 00		
Fabric F40		87.680,00	109.600,00
Fabric F60		93.040,00	116.300,00
Fabric F80		99.200,00	124.000,00
Fabric F120		111.840,00	139.800,00
Surcharge Base			
Colour group 1		0,00	0,00
Colour group 2		376,00	470,00

Fabric F40	Fabric F60	Fabric F80	Fabric F120	Legs group 1	Legs group 2
. Laser RE	. Volo	. Cosy 2 . Tress	. Credo . Track	01 chrome 12 deep black powder-coated (smooth)	06 Japanese red powder-coated (smooth) 32 dark grey powder-coated (smooth) 52 soft light powder-coated (smooth) 91 mint powder-coated (smooth)

Alcove Plus Work

Ronan & Erwan Bouroullec, 2021

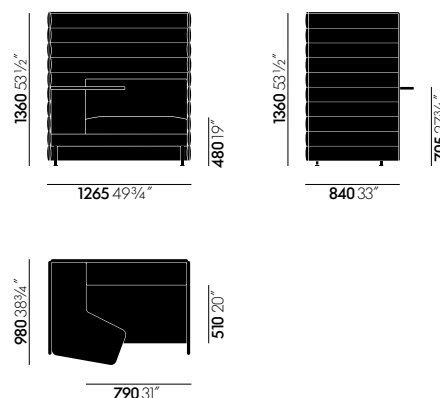

Alcove Plus Work

Alcove Plus Work, tablet desk left

All measurements are pursuant to EN 1335-1:2000
More detailed information is found in the chapter 'Explanation of measurements'.

Structural frame: metal frame with MDF base board.

Body: back and side panels with organic fibreboard core, connected with zip fasteners. Quilted cover with polyester-fibre padding. A zip fastener along the front edge of the side panels allows for attachment to the optional Alcove Plus Paravent.

Seat/back cushions: polyurethane foam and polyester fibre.

Seat height: 480 mm (385 mm with applied load, measured in accordance with EN 1335-1:2000).

Box: wooden carcass covered in polyurethane foam.

Tablet desk: thickness 25 mm, high-density three-ply fine particle board with melamine coating and 3-mm ABS edge; or MDF board, powder-coated (textured finish); or in oak veneer (sourced in Europe) with straight veneered edge 2.5-3.0 mm.

Covers: removable.

Legs: steel, chrome-plated or powder-coated (smooth). Felt glides.



Alcove Plus Work

Ronan & Erwan Bouroullec, 2021

vitra.

Alcove Plus Work	Article no.	without VAT in SEK*	with VAT in SEK*
		210 688 00	
Fabric F40		63.920,00	79.900,00
Fabric F60		67.280,00	84.100,00
Fabric F80		71.120,00	88.900,00
Fabric F120		79.200,00	99.000,00
Surcharge legs			
Colour group 1		0,00	0,00
Colour group 2		376,00	470,00
Surcharges tray			
melamine soft light	A1S52	0,00	0,00
MDF powder-coated in soft light	B1S52	2.552,00	3.190,00
MDF powder-coated basic dark	B1S30	2.552,00	3.190,00
light oak	C1S17	5.080,00	6.350,00
black oak	C1S50	5.080,00	6.350,00
Surcharges tray electrification			
not included	00	0,00	0,00
Punto wireless charging (including USB cable and power supply)	01	5.400,00	6.750,00
Port 120, frame and cover in soft light	5252	1.760,00	2.200,00
Port 120, frame and cover in basic dark	3030	1.760,00	2.200,00
Port 120, frame polished / cover in basic dark	0330	2.072,00	2.590,00
Surcharges equipment for Port 120			
not included	00	0,00	0,00
1x power	01	1.880,00	2.350,00
1x USB charger A-C	12	4.680,00	5.850,00
1x USB charger C	15	4.400,00	5.500,00

Fabric F40	Fabric F60	Fabric F80	Fabric F120
. Laser RE	. Volo	. Cosy 2 . Tress	. Credo . Track

Legs group 1	Legs group 2	Placement of box
01 chrome	06 Japanese red powder-coated (smooth)	01/R Armrest right/sitting left
12 deep black powder-coated (smooth)	32 dark grey powder-coated (smooth)	02/L Armrest left/sitting right
	52 soft light powder-coated (smooth)	
	91 mint powder-coated (smooth)	

Alcove Plus Work

Ronan & Erwan Bouroullec, 2021

vitra.

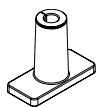

For attaching table lamps to port cable outlet; inner diameter: 10 mm; including reduction sleeve and assembly materials, excl. lamp.

Lamp adapter for port

	Article no.	without VAT in SEK*	with VAT in SEK*
aluminium powder-coated in soft light	853 466 11	752,00	940,00
polished aluminium	853 466 12	856,00	1.070,00



Including 4 zip fasteners

Cable net long

		Article no.	without VAT in SEK*	with VAT in SEK*
W 30 x L 1500 mm	polyester basic dark	833 040 02	560,00	700,00
W 30 x L 1500 mm	polyester grey	833 040 12	560,00	700,00



Alcove Plus Desk

Ronan & Erwan Bouroullec, 2021

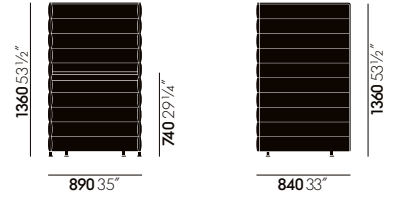

Alcove Plus Desk Small

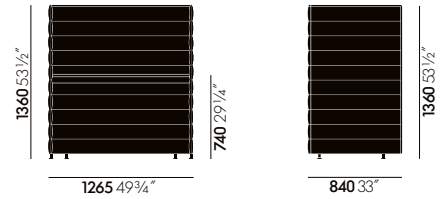

Alcove Plus Desk Medium

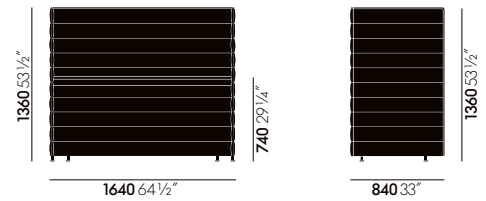

Alcove Plus Desk Large

All measurements are pursuant to EN 1335-1:2000
More detailed information is found in the chapter 'Explanation of measurements'.

Alcove Plus Desk

Ronan & Erwan Bouroullec, 2021

Body/structure: back and side panels with organic fibreboard core and metal frame, connected with zip fasteners. Quilted covers with polyester-fibre padding. A zip fastener along the front edge of the side panels allows for attachment to the optional Alcove Plus Paravent. Metal frame for stabilisation of back and side panels and for support of table top.

Covers: removable.

Table top: thickness 25 mm, high-density three-ply fine particle board with melamine coating and 3-mm ABS edge; or MDF board, powder-coated (textured finish); or in oak veneer (sourced in Europe) with straight veneered edge 2.5-3.0 mm.

Table height: 740 mm.

Cable basket: steel wire, powder-coated in black, W 444 x D 114 x H 164 mm. Maximum number of baskets for large desk: 3 units; medium desk: 2 units; and small desk: 1 unit.

Legs: tubular steel, chrome-plated or powder-coated (smooth). Non-slip glides, levelling adjustment +/- 10mm.

Electrification: When 'table-top electrification' is selected, please configure the suitable Port 120 or 180 as required and order separately along with the feed cable, cable conduit, under-table electrification, distribution block etc. At least one Alcove Plus Desk cable basket is required per Port. The simplest electrification version does not require a Port; cables can be installed on the surface of the table between the table top and panel. The minimum requirement is one cable basket, one power outlet strip and one feed cable. These must also be ordered separately.



Alcove Plus Desk

Ronan & Erwan Bouroullec, 2021

vitra.

Alcove Plus Desk Small	Article no.	without VAT in SEK*	with VAT in SEK*
	210 689 00		
Fabric F40		45.040,00	56.300,00
Fabric F60		47.360,00	59.200,00
Fabric F80		49.920,00	62.400,00
Fabric F120		55.360,00	69.200,00
Surcharge Base			
Colour group 1		0,00	0,00
Colour group 2		376,00	470,00
Surcharges table top 745 x 700 mm			
melamine soft light	A1S52	0,00	0,00
MDF powder-coated in soft light	B1S52	2.472,00	3.090,00
MDF powder-coated basic dark	B1S30	2.472,00	3.090,00
light oak	C1S17	4.952,00	6.190,00
black oak	C1S50	4.952,00	6.190,00
Surcharges table top electrification			
not provided	00	0,00	0,00
cut-out for Port 120 on right	01	464,00	580,00
cut-out for Port 120 on left	02	464,00	580,00

Alcove Plus Desk Medium	Article no.	without VAT in SEK*	with VAT in SEK*
	210 690 00		
Fabric F40		50.400,00	63.000,00
Fabric F60		52.880,00	66.100,00
Fabric F80		55.680,00	69.600,00
Fabric F120		61.680,00	77.100,00
Surcharge Base			
Colour group 1		0,00	0,00
Colour group 2		376,00	470,00
Surcharges table top 1120 x 700 mm			
melamine soft light	A1S52	0,00	0,00
MDF powder-coated in soft light	B1S52	3.032,00	3.790,00
MDF powder-coated basic dark	B1S30	3.032,00	3.790,00
light oak	C1S17	6.072,00	7.590,00
black oak	C1S50	6.072,00	7.590,00
Surcharges table top electrification			
not provided	00	0,00	0,00
cut-out for Port 180 on right	01	464,00	580,00
cut-out for Port 180 on left	02	464,00	580,00

Fabric F40	Fabric F60	Fabric F80	Fabric F120	Legs group 1	Legs group 2
· Laser RE	· Volo	· Cosy 2 · Tress	· Credo · Track	01 chrome 12 deep black powder-coated (smooth)	06 Japanese red powder-coated (smooth) 32 dark grey powder-coated (smooth) 52 soft light powder-coated (smooth) 91 mint powder-coated (smooth)

Alcove Plus Desk

Ronan & Erwan Bouroullec, 2021

vitra.

Alcove Plus Desk Large	Article no.	without VAT in SEK*	with VAT in SEK*
	210 691 00		
Fabric F40		54.880,00	68.600,00
Fabric F60		57.760,00	72.200,00
Fabric F80		61.120,00	76.400,00
Fabric F120		67.920,00	84.900,00
Surcharge Base			
Colour group 1		0,00	0,00
Colour group 2		376,00	470,00
Surcharges table top 1495 x 700 mm			
melamine soft light	A1S52	0,00	0,00
MDF powder-coated in soft light	B1S52	3.512,00	4.390,00
MDF powder-coated basic dark	B1S30	3.512,00	4.390,00
light oak	C1S17	6.952,00	8.690,00
black oak	C1S50	6.952,00	8.690,00
Surcharges table top electrification			
not provided	00	0,00	0,00
cut-out for Port 180 on right	01	464,00	580,00
cut-out for Port 180 on left	02	464,00	580,00

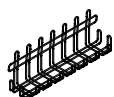

Cable basket	Article no.	without VAT in SEK*	with VAT in SEK*	
Steel wire, powder-coated in basic dark	W 444 x D 114 x H 164 mm	210 692 00	944,00	1.180,00

Maximum number of cable baskets for large desk: 3 units; medium desk: 2 units; and small desk: 1 unit

Fabric F40	Fabric F60	Fabric F80	Fabric F120	Legs group 1	Legs group 2
. Laser RE	. Volo	. Cosy 2 . Tress	. Credo . Track	01 chrome 12 deep black powder-coated (smooth)	06 Japanese red powder-coated (smooth) 32 dark grey powder-coated (smooth) 52 soft light powder-coated (smooth) 91 mint powder-coated (smooth)

Alcove Plus Desk

Ronan & Erwan Bouroullec, 2021

vitra.



Cable outlet with power supply option to be installed in table tops 22-27 mm thick

Port 120	Article no.	without VAT in SEK*	with VAT in SEK*
833 401 01			
Equipment			
without modules	0000		
1x Current Module power	AP01	1.216,00	1.520,00
1x Current Module Data (2x)	AP04	2.496,00	3.120,00
1x Current Module USB charger A-C	AP12	4.224,00	5.280,00
1x Current Module USB charger C	AP15	4.016,00	5.020,00
Surface			
aluminium powder-coated in soft light / plastic in soft light	OF5252	1.328,00	1.660,00
aluminium powder-coated in basic dark / plastic in basic dark	OF3030	1.328,00	1.660,00
aluminium polished / plastic in basic dark	OF0330	1.640,00	2.050,00
Basic price:		1.328,00	1.660,00

Order: Optional current module power comes with a GST18 plug. Please order feed and connecting cables separately. Please provide separate cables to connect RJ45 and USB.



Power cable inlet for installation in table tops of thickness 22-27 mm

Port 180	Article no.	without VAT in SEK*	with VAT in SEK*
833 402 01			
Equipment			
without modules	0000		
1x Current Module power	AP01	1.184,00	1.480,00
2x Current Module power	AP02	2.400,00	3.000,00
1x Current power + 1x data 2x	AP03	2.792,00	3.490,00
1x Current power +1 cable hol.	AP05	2.400,00	3.000,00
1x Cur.pow. + 1x VGA, 3,5 jack	AP06	3.584,00	4.480,00
1x Current pow. + 1x RJ45 HDMI	AP07	3.584,00	4.480,00
1x Current power + 1x USB (2x)	AP08	2.792,00	3.490,00
1x Cur.pow. +1x USB charg. A-C	AP13	5.288,00	6.610,00
1x Cur.pow. +1x USB charger C	AP16	5.032,00	6.290,00
Surface			
alum. s.light/ plastic s.light	OF5252	1.544,00	1.930,00
aluminium powder-coated in basic dark / plastic in basic dark	OF3030	1.544,00	1.930,00
aluminium polished / plastic in basic dark	OF0330	1.856,00	2.320,00
Basic price:		1.544,00	1.930,00

Order: optional Current modules (power) are supplied with GST18 connectors. A distribution block is required for use of ,2x Current module (power)' (AP02). Please order distribution block and, if necessary, feed cables separately. Cables for RJ45 and USB connections to be provided separately.

Alcove Plus Desk

Ronan & Erwan Bouroullec, 2021



For attaching table lamps to port cable outlet; inner diameter: 10 mm; including reduction sleeve and assembly materials, excl. lamp.

Lamp adapter for port	Article no.	without VAT in SEK*	with VAT in SEK*
aluminium powder-coated in soft light	853 466 11	752,00	940,00
polished aluminium	853 466 12	856,00	1.070,00



For attaching monitor arms to port cable outlet; inner diameter: 14 mm; including reduction sleeve and assembly materials, excl. monitor arm.

Monitor adapter for port	Article no.	without VAT in SEK*	with VAT in SEK*
aluminium powder-coated in soft light	853 465 11	720,00	900,00
polished aluminium	853 465 12	856,00	1.070,00



Power outlet for workstations with technical unit or for direct attachment to cable basket; without feed cables, connecting cables or patch cables.

Ordering: please order feed and connecting cables separately.

Tens Kit 4	Article no.	without VAT in SEK*	with VAT in SEK*
	833 412 01		
Electrification			
DE, AT, NL, ES norm	EL01		
Equipment slot 1			
1x power including housing	1AS01	400,00	500,00
Equipment slot 2			
1x power	2AS01	248,00	310,00
Equipment slot 3			
1x power	3AS01	248,00	310,00
2x RJ45	3AS02	1.408,00	1.760,00
1x HDMI + 1x USB	3AS03	1.792,00	2.240,00
1x VGA + 3 mm jack	3AS04	1.528,00	1.910,00
Equipment slot 4			
1x power	4AS01	248,00	310,00
2x RJ45	4AS02	1.408,00	1.760,00
1x HDMI + 1x USB	4AS03	1.792,00	2.240,00
1x VGA + 3.5mm jack	4AS04	1.528,00	1.910,00
	Basic price:	1.144,00	1.430,00

Alcove Plus Desk

Ronan & Erwan Bouroullec, 2021

vitra.

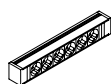

Power outlet for workstations with technical unit or for direct attachment to cable basket; without feed cables, connecting cables or patch cables.

Tens Kit 6	Article no.	without VAT in SEK*	with VAT in SEK*
	833 413 01		
Electrification			
DE, AT, NL, ES norm	EL01		
Equipment slot 1			
1x power including housing	1AS01	472,00	590,00
Equipment slot 2			
1x power	2AS01	248,00	310,00
Equipment slot 3			
1x power	3AS01	248,00	310,00
Equipment slot 4			
1x power	4AS01	248,00	310,00
2x RJ45	4AS02	1.408,00	1.760,00
1x HDMI + 1x USB	4AS03	1.792,00	2.240,00
1x VGA + 3.5mm jack	4AS04	1.528,00	1.910,00
Equipment slot 5			
1x power	5AS01	248,00	310,00
2x RJ45	5AS02	1.408,00	1.760,00
1x HDMI + 1x USB	5AS03	1.792,00	2.240,00
1x VGA + 3.5mm jack	5AS04	1.528,00	1.910,00
Equipment slot 6			
1x power	6AS01	248,00	310,00
2x RJ45	6AS02	1.408,00	1.760,00
1x HDMI + 1x USB	6AS03	1.792,00	2.240,00
1x VGA + 3.5mm jack	6AS04	1.528,00	1.910,00
	Basic price:	1.712,00	2.140,00

Ordering: please order feed and connecting cables separately.

Alcove Plus Desk

Ronan & Erwan Bouroullec, 2021

vitra.

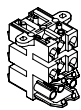

supplies power to up to 5 sockets

Distribution block		Article no.	without VAT in SEK*	with VAT in SEK*
H 60 x W 50 x D 50 mm	black plastic	856 824 00	568,00	710,00



Including 4 zip fasteners

Cable net long		Article no.	without VAT in SEK*	with VAT in SEK*
W 30 x L 1500 mm	polyester basic dark	833 040 02	560,00	700,00
W 30 x L 1500 mm	polyester grey	833 040 12	560,00	700,00



Connection cables		Article no.	without VAT in SEK*	with VAT in SEK*
Connection cable L100	black plastic	853 408 11	432,00	540,00



L300 feed cable		Article no.	without VAT in SEK*	with VAT in SEK*
		833 017 20		
Electrification			656,00	820,00
DE, AT, NL, ES norm with 300 cm power feed cable		ELE01		

Alcove Plus Paravent

Ronan & Erwan Bouroullec, 2021

vitra.

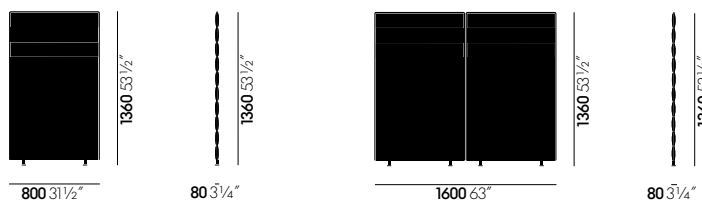

Alcove Plus Paravent

Alcove Plus Paravent one-piece

Alcove Plus Paravent two-piece

All measurements are pursuant to EN 1335-1:2000
More detailed information is found in the chapter 'Explanation of measurements'.

Paravent: panel with organic fibreboard core. Quilted cover with polyester-fibre padding and a zip fastener on both sides for attachment to other Alcove Plus elements: Sofa, Love Seat, Work or Desk.

Cover: removable.

Legs: steel, chrome-plated or powder-coated (smooth). Felt glides.

Note: Alcove Plus Paravents are not designed for free-standing use. They must always be connected to another Alcove Plus element: Sofa, Work or Desk.

Alcove Plus Paravent one-piece

	Article no.	without VAT in SEK*	with VAT in SEK*
		210 693 00	
Fabric F40		14.000,00	17.500,00
Fabric F60		14.880,00	18.600,00
Fabric F80		16.240,00	20.300,00
Fabric F120		18.640,00	23.300,00
Surcharge Base			
Colour group 1		0,00	0,00
Colour group 2		376,00	470,00

Alcove Plus Paravent two-piece

	Article no.	without VAT in SEK*	with VAT in SEK*
		210 694 00	
Fabric F40		22.080,00	27.600,00
Fabric F60		23.840,00	29.800,00
Fabric F80		25.680,00	32.100,00
Fabric F120		29.600,00	37.000,00
Surcharge Base			
Colour group 1		0,00	0,00
Colour group 2		376,00	470,00

Fabric F40	Fabric F60	Fabric F80	Fabric F120	Legs group 1	Legs group 2
· Laser RE	· Volo	· Cosy 2 · Tress	· Credo · Track	01 chrome 12 deep black powder-coated (smooth)	06 Japanese red powder-coated (smooth) 32 dark grey powder-coated (smooth) 52 soft light powder-coated (smooth) 91 mint powder-coated (smooth)

Grand Sofà

Antonio Citterio, 2017

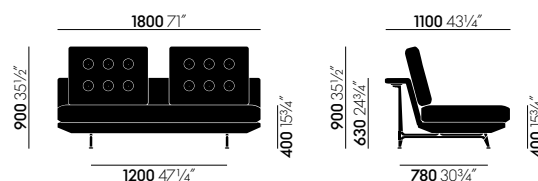

2 1/2-Seater - full backrest, one-piece seat cushion

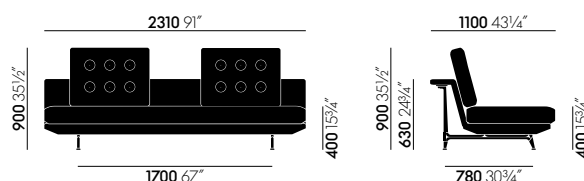

3-Seater - full backrest, one-piece seat cushion

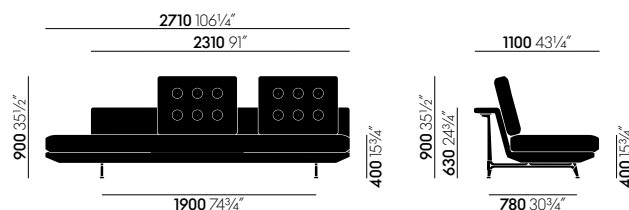

3 1/2-Seater - open on left, one-piece seat cushion

Grand Sofà

Body: metal frame with moulded polyurethane foam.

Seat cushions: polyurethane foam core and chamber cushion (filled with polyurethane foam lozenges, latex and a mix of goose feathers and down).

Lumbar cushion 60 x 30 x 6 cm: filled with a mix of feathers/down and ball fibre.

Back cushion 60 x 52 x 8 cm: filled with a mix of feathers/down and ball fibre.

Back cushion 70 x 60 x 8 cm: filled with a mix of feathers/down and ball fibre – combination with neck cushion recommended.

Back cushion 90 x 60 x 8 cm, latex filling: heavy filling of latex and feathers – cushion nestles against the angled backrest when used without neck cushion.

Armrest cushion 59 x 27 x 15 cm: filled with a mix of feathers/down and ball fibre, sand-weighted.

Neck cushion 70 x 17 x 15 cm: filled with a mix of feathers/down and ball fibre, sand-weighted.

Covers: removable.

Legs: die-cast aluminium, polished or powder-coated.

Glides: non-slip.

Accessory: Sofa Tray made of steel, covered with split leather.

Note: the designations ‚left‘ and ‚right‘ refer to the perspective when viewing the sofa from the front.

Note: with the exception of neck and armrest cushions, all cushions are available in a tufted version.

Note: back cushions are not included with the sofa and must be ordered separately.

Note: cushions should be regularly shaken and plumped to retain their fullness and shape.

Applications: recommended for domestic use only.

Grand Sofà

Antonio Citterio, 2017

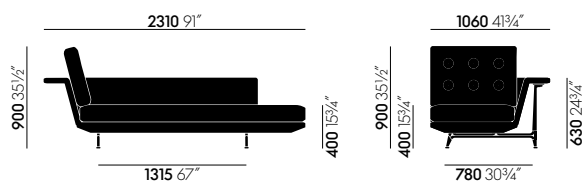

Chaise Longue - right, one-piece seat cushion



Bench

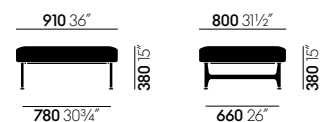

Ottoman

Grand Sofà Bench

Structure: metal frame with wooden panel, polyurethane foam and chamber cushion filled with polyurethane foam lozenges, latex and a mix of goose feathers and down. Cushion in tufted version only.

Covers: removable.

Legs: die-cast aluminium, polished or powder-coated.

Glides: anti-slip glides.

Grand Sofà Ottoman

Structure: wooden panel, polyurethane foam and a chamber cushion filled with polyurethane foam rods, latex and a mix of goose feathers and down. Cushion in tufted version only.

Covers: removable.

Legs: die-cast aluminium, polished or powder-coated.

Glides: anti-slip glides.

Accessory: Sofa Tray made of steel, covered with split leather.

Grand Sofà

Antonio Citterio, 2017

with VAT in SEK*

	F40 Mello	F80 Corsaro Cosy 2 Dumet Iroko 2 Linho	F100 Reed	F120 Credo	
2½-Seater					
full backrest	210 526 00	73.900,00	78.600,00	81.100,00	83.900,00
surcharge individual seat cushions, tufted		7.890,00	7.890,00	7.890,00	7.890,00
surcharge one-piece seat cushion, tufted		11.900,00	11.900,00	11.900,00	11.900,00
3-Seater					
open on right	210 499 00	79.200,00	84.200,00	87.500,00	91.200,00
open on left	210 498 00	79.200,00	84.200,00	87.500,00	91.200,00
full backrest	210 497 00	79.200,00	84.200,00	87.500,00	91.200,00
surcharge individual seat cushions, tufted		8.490,00	8.490,00	8.490,00	8.490,00
surcharge one-piece seat cushion, tufted		13.300,00	13.300,00	13.300,00	13.300,00
3½-Seater					
open on right	210 525 00	91.000,00	96.800,00	101.200,00	104.600,00
open on left	210 524 00	91.000,00	96.800,00	101.200,00	104.600,00
full backrest	210 523 00	91.000,00	96.800,00	101.200,00	104.600,00
surcharge individual seat cushions, tufted		9.550,00	9.550,00	9.550,00	9.550,00
surcharge one-piece seat cushion, tufted		15.200,00	15.200,00	15.200,00	15.200,00
Chaise Longue					
right	210 528 00	75.500,00	80.500,00	83.300,00	87.000,00
left	210 527 00	75.500,00	80.500,00	83.300,00	87.000,00
surcharge individual seat cushions, tufted		8.090,00	8.090,00	8.090,00	8.090,00
surcharge one-piece seat cushion, tufted		12.700,00	12.700,00	12.700,00	12.700,00
Ottoman					
tufted cushion	210 537 00	31.600,00	32.900,00	33.500,00	34.400,00
Bench					
tufted cushion	210 539 00	54.700,00	56.600,00	58.300,00	59.600,00

Grand Sofà

Antonio Citterio, 2017

vitra.

with VAT in SEK*

F40
Mello

F80
Corsaro
Cosy 2
Dumet
Iroko 2
Linho
Savana

F100
Nubia
Reed

F120
Credo

backrest cushions

60 x 52 x 8 cm	210 529 00	3.650,00	4.690,00	5.450,00	6.090,00
surcharge tufted upholstery		460,00	460,00	460,00	460,00
70 x 60 x 8 cm	210 530 00	4.590,00	5.850,00	6.690,00	7.450,00
surcharge tufted upholstery		600,00	600,00	600,00	600,00
90 x 60 x 8 cm, latex filling	210 532 00	5.100,00	6.690,00	7.550,00	8.490,00
surcharge tufted upholstery		650,00	650,00	650,00	650,00

lumbar cushion

60 x 30 x 6 cm	210 533 00	2.790,00	3.650,00	3.990,00	4.550,00
surcharge tufted upholstery		340,00	340,00	340,00	340,00

neck support cushion

70 x 17 x 15 cm	210 534 00	2.650,00	3.850,00	4.550,00	5.250,00
-----------------	-------------------	----------	----------	----------	----------

armrest cushion

59 x 27 x 15 cm	210 535 00	3.250,00	4.450,00	5.250,00	5.850,00
-----------------	-------------------	----------	----------	----------	----------

Grand Sofà

Antonio Citterio, 2017

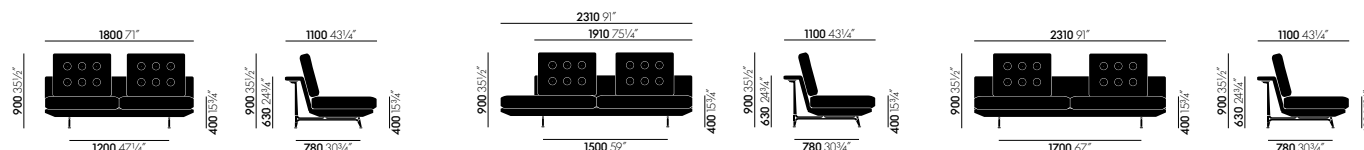

2½-Seater - full backrest, individual seat cushions

3-Seater - open on left, individual seat cushions

3-Seater - full backrest, individual seat cushions

Grand Sofà 2½-Seater

	Article no.	without VAT in SEK*	with VAT in SEK*
	210 526 00		
Fabric F40		59.120,00	73.900,00
Fabric F80		62.880,00	78.600,00
Fabric F100		64.880,00	81.100,00
Fabric F120		67.120,00	83.900,00

Surcharge for tufting and seat cushions

seat cushion, divided, non-tufted	01	0,00	0,00
individual seat cushions, tufted	02	6.312,00	7.890,00
seat cushion, one-piece, tufted	03	9.520,00	11.900,00

Grand Sofà 3-Seater

	Article no.	without VAT in SEK*	with VAT in SEK*
open on right	210 499 00		
Fabric F40		63.360,00	79.200,00
Fabric F80		67.360,00	84.200,00
Fabric F100		70.000,00	87.500,00
Fabric F120		72.960,00	91.200,00
open on left	210 498 00		
Fabric F40		63.360,00	79.200,00
Fabric F80		67.360,00	84.200,00
Fabric F100		70.000,00	87.500,00
Fabric F120		72.960,00	91.200,00
full backrest	210 497 00		
Fabric F40		63.360,00	79.200,00
Fabric F80		67.360,00	84.200,00
Fabric F100		70.000,00	87.500,00
Fabric F120		72.960,00	91.200,00

Surcharge for tufting and seat cushions

Upholstery version seat cushion, divided, non-tufted	01	0,00	0,00
Upholstery version individual seat cushions, tufted	02	6.792,00	8.490,00
Upholstery version seat cushion, one-piece, tufted	03	10.640,00	13.300,00

Fabric F40	Fabric F80	Fabric F100	Fabric F120	Base
. Mello	. Corsaro	. Nubia	. Credo	03 polished aluminium
	. Cosy 2	. Reed		30 basic dark powder-coated (smooth)
	. Dumet			
	. Iroko 2			
	. Linho			
	. Savana			

Grand Sofà

Antonio Citterio, 2017

vitra.

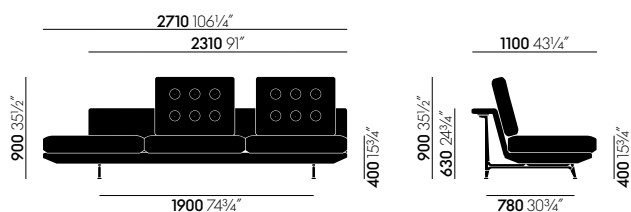

3 1/2-Seater - open on left, individual seat cushions

Grand Sofà 3 1/2-Seater

	Article no.	without VAT in SEK*	with VAT in SEK*
open on right	210 525 00		
Fabric F40		72.800,00	91.000,00
Fabric F80		77.440,00	96.800,00
Fabric F100		80.960,00	101.200,00
Fabric F120		83.680,00	104.600,00
open on left	210 524 00		
Fabric F40		72.800,00	91.000,00
Fabric F80		77.440,00	96.800,00
Fabric F100		80.960,00	101.200,00
Fabric F120		83.680,00	104.600,00
full backrest	210 523 00		
Fabric F40		72.800,00	91.000,00
Fabric F80		77.440,00	96.800,00
Fabric F100		80.960,00	101.200,00
Fabric F120		83.680,00	104.600,00

Surcharge for tufting and seat cushions

Upholstery version seat cushion, divided, non-tufted	01	0,00	0,00
Upholstery version individual seat cushions, tufted	02	7.640,00	9.550,00
Upholstery version seat cushion, one-piece, tufted	03	12.160,00	15.200,00

Fabric F40	Fabric F80	Fabric F100	Fabric F120	Base
. Mello	. Corsaro	. Nubia	. Credo	03 polished aluminium
	. Cosy 2	. Reed		30 basic dark powder-coated (smooth)
	. Dumet			
	. Iroko 2			
	. Linho			
	. Savana			

Grand Sofà

Antonio Citterio, 2017

vitra.

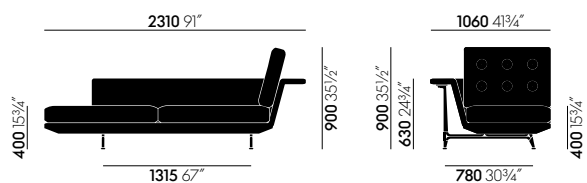

Chaise Longue - left, individual seat cushions

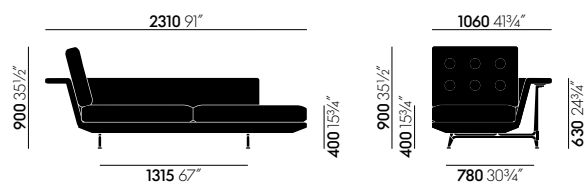

Chaise Longue - right, individual seat cushions

Grand Sofà Chaise Longue

	Article no.	without VAT in SEK*	with VAT in SEK*
right	210 528 00		
Fabric F40		60.400,00	75.500,00
Fabric F80		64.400,00	80.500,00
Fabric F100		66.640,00	83.300,00
Fabric F120		69.600,00	87.000,00
left	210 527 00		
Fabric F40		60.400,00	75.500,00
Fabric F80		64.400,00	80.500,00
Fabric F100		66.640,00	83.300,00
Fabric F120		69.600,00	87.000,00

Surcharge for tufting and seat cushions

Upholstery version seat cushion, divided, non-tufted	01	0,00	0,00
Upholstery version individual seat cushions, tufted	02	6.472,00	8.090,00
Upholstery version seat cushion, one-piece, tufted	03	10.160,00	12.700,00

Fabric F40	Fabric F80	Fabric F100	Fabric F120	Base
. Mello	. Corsaro	. Nubia	. Credo	03 polished aluminium
	. Cosy 2	. Reed		30 basic dark powder-coated (smooth)
	. Dumet			
	. Iroko 2			
	. Linho			
	. Savana			

Grand Sofà

Antonio Citterio, 2017

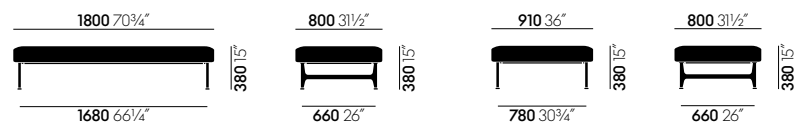

Bench

Ottoman

Grand Sofà Bench

	Article no.	without VAT in SEK*	with VAT in SEK*
Tufted cushion	210 539 00		
Fabric F40		43.760,00	54.700,00
Fabric F80		45.280,00	56.600,00
Fabric F100		46.640,00	58.300,00
Fabric F120		47.680,00	59.600,00

Grand Sofà Ottoman

	Article no.	without VAT in SEK*	with VAT in SEK*
Tufted cushion	210 537 00		
Fabric F40		25.280,00	31.600,00
Fabric F80		26.320,00	32.900,00
Fabric F100		26.800,00	33.500,00
Fabric F120		27.520,00	34.400,00

Fabric F40	Fabric F80	Fabric F100	Fabric F120	Base
. Mello	. Corsaro	. Nubia	. Credo	03 polished aluminium
	. Cosy 2	. Reed		30 basic dark powder-coated (smooth)
	. Dumet			
	. Iroko 2			
	. Linho			
	. Savana			

Grand Sofà

Antonio Citterio, 2017

vitra.

Grand Sofà backrest cushions	Article no.	without VAT in SEK*	with VAT in SEK*
60 x 52 x 8 cm	210 529 00		
Fabric F40		2.920,00	3.650,00
Fabric F80		3.752,00	4.690,00
Fabric F100		4.360,00	5.450,00
Fabric F120		4.872,00	6.090,00

Surcharge tufting

Upholstery version non-tufted	01	0,00	0,00
Upholstery version tufted	02	368,00	460,00

70 x 60 x 8 cm	210 530 00		
Fabric F40		3.672,00	4.590,00
Fabric F80		4.680,00	5.850,00
Fabric F100		5.352,00	6.690,00
Fabric F120		5.960,00	7.450,00

Surcharge tufting

Upholstery version non-tufted	01	0,00	0,00
Upholstery version tufted	02	480,00	600,00

90 x 60 x 8 cm, latex filling	210 532 00		
Fabric F40		4.080,00	5.100,00
Fabric F80		5.352,00	6.690,00
Fabric F100		6.040,00	7.550,00
Fabric F120		6.792,00	8.490,00

Surcharge tufting

Upholstery version non-tufted	01	0,00	0,00
Upholstery version tufted	02	520,00	650,00

Fabric F40	Fabric F80	Fabric F100	Fabric F120
. Mello	. Corsaro . Cosy 2 . Dumet . Iroko 2 . Linho . Savana	. Nubia . Reed	. Credo



Grand Sofà

Antonio Citterio, 2017

vitra.

Grand Sofà lumbar cushion

	Article no.	without VAT in SEK*	with VAT in SEK*
60 x 30 x 6 cm	210 533 00		
Fabric F40		2.232,00	2.790,00
Fabric F80		2.920,00	3.650,00
Fabric F100		3.192,00	3.990,00
Fabric F120		3.640,00	4.550,00
Surcharge tufting			
Upholstery version non-tufted	01	0,00	0,00
Upholstery version tufted	02	272,00	340,00

Grand Sofà neck support cushion

	Article no.	without VAT in SEK*	with VAT in SEK*
70 x 17 x 15 cm	210 534 00		
Fabric F40		2.120,00	2.650,00
Fabric F80		3.080,00	3.850,00
Fabric F100		3.640,00	4.550,00
Fabric F120		4.200,00	5.250,00

Grand Sofà armrest cushion

	Article no.	without VAT in SEK*	with VAT in SEK*
59 x 27 x 15 cm	210 535 00		
Fabric F40		2.600,00	3.250,00
Fabric F80		3.560,00	4.450,00
Fabric F100		4.200,00	5.250,00
Fabric F120		4.680,00	5.850,00

Fabric F40	Fabric F80	Fabric F100	Fabric F120
. Mello	. Corsaro	. Nubia	. Credo
	. Cosy 2	. Reed	
	. Dumet		
	. Iroko 2		
	. Linho		
	. Savana		

Sofa Tray

Antonio Citterio, 2017

vitra.

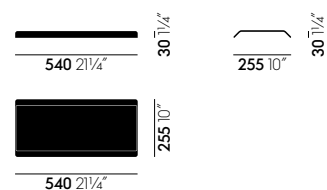

Material: steel, covered with split leather.

Sofa Tray

540 x 254 x 30 mm

covered with Leather Forte (Deco)

Article no. without VAT in SEK* with VAT in SEK*

210 536 00

3.400,00

4.250,00

Leather Forte (deco)

- 01 cognac (dark)
- 02 marron (dark)
- 03 umbra grey
- 04 chocolate
- 05 nero
- 07 sand

Freeform Sofa

Isamu Noguchi, 1946

vitra.

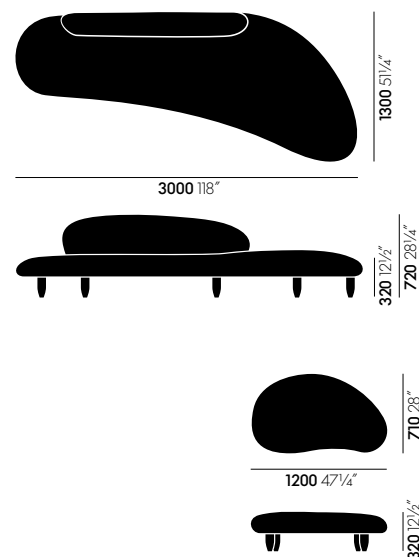

Frame: solid beech.

Body and cushions: wooden frame with polyurethane foam.

Covers: removable.

Seat height: 320 mm (280 mm with applied load, measured in accordance with EN 1335-1).

Legs: solid maple, natural finish or walnut stain.

Origin of wood: beech (*Fagus sylvatica*), maple (*Acer platanoides*) and walnut (*Juglans regia*) from Poland and Austria.

Freeform Sofa	Article no.	without VAT in SEK*	with VAT in SEK*
	210 182 00		
Fabric F120		89.680,00	112.100,00

Ottoman	Article no.	without VAT in SEK*	with VAT in SEK*
	210 181 00		
Fabric F120		25.120,00	31.400,00

Fabric F120

Legs

. Credo

maple, stained walnut-coloured
54 maple

Mariposa Club Armchair

Edward Barber & Jay Osgerby, 2017

vitra.

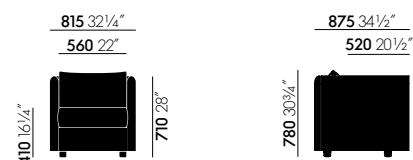

All measurements are pursuant to EN 1335-1:2000
More detailed information is found in the chapter 'Explanation of measurements'.

Structural frame: webbed metal frame with polyurethane foam.

Seat cushions: multilayer PU foam upholstery.

Back cushions: foam cube and ball fibre filling; back cushions attached to backrest by zip fastener.

Seat height: 410 mm (309 mm with applied load, measured in accordance with EN 1335-1:2000).

Covers: removable.

Glides: plastic glides with levelling adjustment.

Mariposa Club Armchair

	Article no.	without VAT in SEK*	with VAT in SEK*
	210 480 00		
Fabric F30		24.800,00	31.000,00
Fabric F40		25.440,00	31.800,00
Fabric F60		26.560,00	33.200,00
Fabric F80		27.840,00	34.800,00
Fabric F100		28.880,00	36.100,00
Fabric F120		31.280,00	39.100,00

Fabric F30	Fabric F40	Fabric F60	Fabric F80	Fabric F100	Fabric F120
. Plano	. Laser RE . Mello	. Olimpo . Volo	. Corsaro . Dumet . Iroko 2 . Linho . Savana	. Aura . Nubia . Reed	. Credo

Mariposa Sofa

Edward Barber & Jay Osgerby, 2014

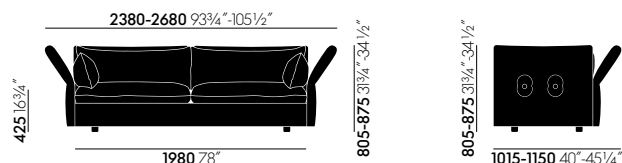

Mariposa 3-Seater

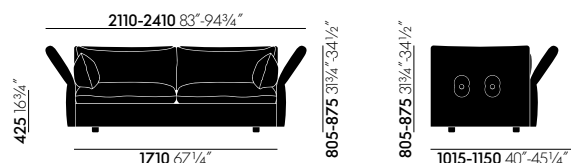

Mariposa 2½-Seater

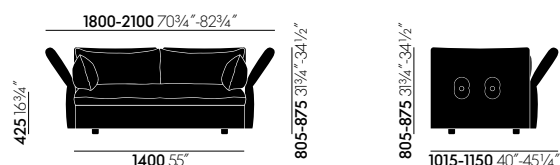

Mariposa 2-Seater



Mariposa Ottoman large

Mariposa Ottoman medium

All measurements are pursuant to EN 1335-1:2000
More detailed information is found in the chapter 'Explanation of measurements'.

Structural frame: webbed metal frame with polyurethane foam.

Seat cushions: polyurethane and visco foams with chamber cushion overlay. Chamber cushion overlay filled with feathers and PU rods.

Back and armrest cushions: chamber cushion filled with stripped-quill feathers and PU rods.

Covers: removable.

Seat height: 425 mm (280 mm with applied load, measured in accordance with EN 1335-1:2000).

Glides: plastic glides with levelling adjustment.

Note: cushions should be regularly shaken and plumped to retain their fullness and shape.

Applications: recommended for home use only.

Note: for transport purposes Mariposa can be partially disassembled. The instructions can be found in the SSE.

Mariposa Ottoman

Base: MDF board with felt glides.

Upholstery: polyurethane foam with polyester fleece.

Range of use: recommended for residential use only.

Mariposa Sofa

Edward Barber & Jay Osgerby, 2014

vitra.

Mariposa 3-Seater		Article no.	without VAT in SEK*	with VAT in SEK*
			210 452 00	
Fabric F40			69.680,00	87.100,00
Fabric F60			74.960,00	93.700,00
Fabric F80			80.400,00	100.500,00
Fabric F100			88.800,00	111.000,00
Fabric F120			97.120,00	121.400,00
Mariposa 2 1/2-Seater		Article no.	without VAT in SEK*	with VAT in SEK*
			210 453 00	
Fabric F40			60.800,00	76.000,00
Fabric F60			65.520,00	81.900,00
Fabric F80			70.080,00	87.600,00
Fabric F100			77.280,00	96.600,00
Fabric F120			84.320,00	105.400,00
Mariposa 2-Seater		Article no.	without VAT in SEK*	with VAT in SEK*
			210 451 00	
Fabric F40			53.040,00	66.300,00
Fabric F60			56.560,00	70.700,00
Fabric F80			60.800,00	76.000,00
Fabric F100			67.360,00	84.200,00
Fabric F120			73.280,00	91.600,00
Mariposa Ottoman large		Article no.	without VAT in SEK*	with VAT in SEK*
			210 455 00	
Fabric F40			8.960,00	11.200,00
Fabric F60			9.760,00	12.200,00
Fabric F80			10.320,00	12.900,00
Fabric F100			11.680,00	14.600,00
Fabric F120			12.400,00	15.500,00
Mariposa Ottoman medium		Article no.	without VAT in SEK*	with VAT in SEK*
			210 454 00	
Fabric F40			7.240,00	9.050,00
Fabric F60			7.800,00	9.750,00
Fabric F80			8.400,00	10.500,00
Fabric F100			9.120,00	11.400,00
Fabric F120			10.000,00	12.500,00

Fabric F40	Fabric F60	Fabric F80	Fabric F100	Fabric F120
. Laser RE	. Olimpo	. Corsaro	. Aura	. Credo
. Mello	. Volo	. Dumet	. Nubia	
		. Iroko 2	. Reed	
		. Linho		
		. Savana		



Mariposa Sofa

Edward Barber & Jay Osgerby, 2014

vitra.

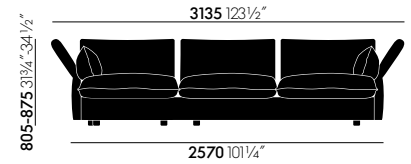
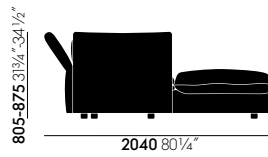
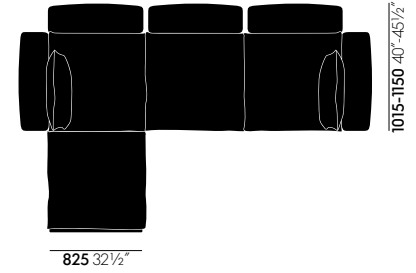

All measurements are pursuant to EN 1335-1:2000
More detailed information is found in the chapter 'Explanation of measurements'.

Structural frame: webbed metal frame with polyurethane foam.

Seat cushions: polyurethane and visco foams with chamber cushion overlay. Chamber cushion overlay filled with feathers and PU rods.

Back and armrest cushions: chamber cushion filled with stripped-quill feathers and PU rods.

Covers: removable.

Seat height: 425 mm (280 mm with applied load, measured in accordance with EN 1335-1:2000).

Glides: plastic glides with levelling adjustment.

Applications: recommended for domestic use only.

Note: the designations ‚left‘ and ‚right‘ refer to the perspective when viewing the sofa from the front.

Mariposa Corner

	Article no.	without VAT in SEK*	with VAT in SEK*
	210 650 00		
Fabric F40		116.800,00	146.000,00
Fabric F60		122.880,00	153.600,00
Fabric F80		132.240,00	165.300,00
Fabric F100		143.120,00	178.900,00
Fabric F120		154.320,00	192.900,00

Fabric F40	Fabric F60	Fabric F80	Fabric F100	Fabric F120	Configuration Chaise Longue
<ul style="list-style-type: none"> . Laser RE . Mello 	<ul style="list-style-type: none"> . Olimpo . Volo 	<ul style="list-style-type: none"> . Corsaro . Dumet . Iroko 2 . Linho . Savana 	<ul style="list-style-type: none"> . Aura . Nubia . Reed 	<ul style="list-style-type: none"> . Credo 	<ul style="list-style-type: none"> 01/R Chaise Longue right / sitting left 02/L Chaise Longue left / sitting right

Polder

Hella Jongerius, 2005/2015



Polder Sofa

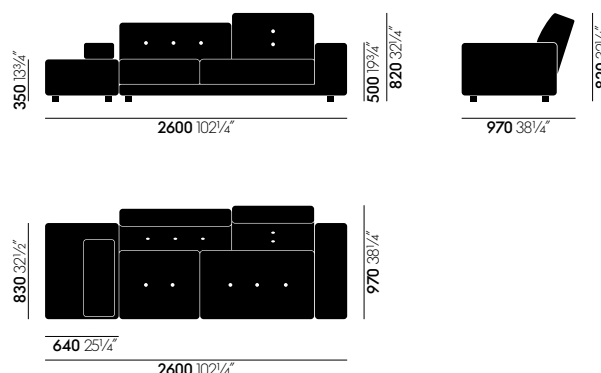

Polder Compact

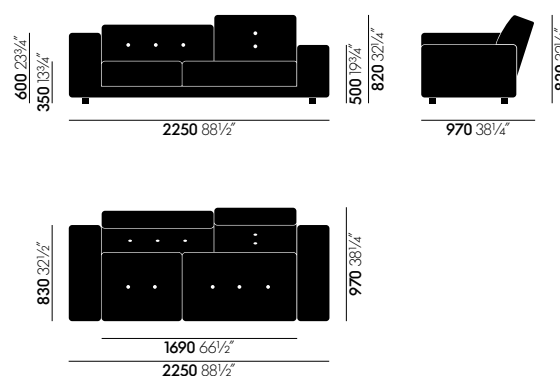

Polder Ottoman

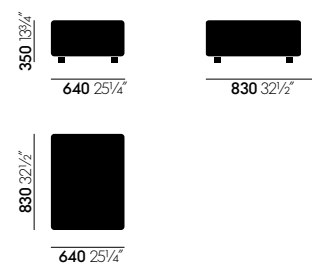

Structural frame: wooden frame.

Seat cushions: polyurethane foam with interactive pocket spring core, chamber cushion structure (filled with foam cubes and lozenges) and polyester fleece.

Back cushions: polyurethane foam with polyester fleece and chamber cushions (filled with foam cubes and lozenges).

Armrest cushion: detached bolster, freely positionable, sand-weighted, polyurethane foam filling.

Cover: coordinated combinations of various colours and fabric types, removable.

Buttons: made of wood or horn, colour and grain subject to natural variations.

Ottoman: wooden frame with polyurethane foam. The fabric and colour of the Ottoman matches that of the sofa.

Applications: recommended for domestic use only.

Note: you will find an overview of the colour and fabric combinations for the different sofa versions in the appendix 'Colour & Material Library'.

Note: the designations 'left' and 'right' refer to the perspective when viewing the sofa from the front.

Polder Sofa	Article no.	without VAT in SEK*	with VAT in SEK*
		210 754 00	
fabric		64.080,00	80.100,00

Polder Compact	Article no.	without VAT in SEK*	with VAT in SEK*
		210 755 00	
fabric		58.000,00	72.500,00

Polder Ottoman	Article no.	without VAT in SEK*	with VAT in SEK*
		210 756 00	
fabric		11.440,00	14.300,00

Fabric mix „The Sea Greens“

05 Aura - steel blue
08 Volo - green-grey
13 Canvas (836)
17 Cosy 2 - reed green
20 Credo - dolphin/steel blue
28 Dumet - sage/steel blue

Fabric mix „The Antarctic Blues“

11 Volo - night blue
18 Tress - royal blue melange
19 Reed - indigo
21 Cosy 2 - dark blue
31 Dumet - indigo melange
37 Remix (762)

Fabric mix „The Earth Reds“

10 Reed - brick
15 Cosy 2 - rusty orange
15 Track - brick/dark red
53 Aura - poppy red
77 Volo - brick
77 Aura - brick

Fabric mix „The Pebble Greys“

03 Aura - sand
03 Mello - cement
03 Reed - stone
07 Track - mid-grey/cream
10 Canvas (124)
14 Volo - iron grey

Configuration armrests Polder Compact

01/R Low armrest right/sitting left
02/L Low armrest left/sitting right

Configuration armrest Polder Sofa

01/R Armrest right/sitting left
02/L Armrest left/sitting right

Set of buttons

01 Light set of buttons
02 Dark set of buttons

Soft Modular Sofa

Jasper Morrison, 2016

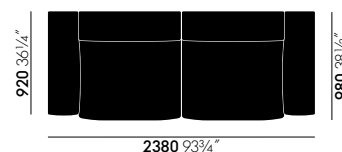

Two seater

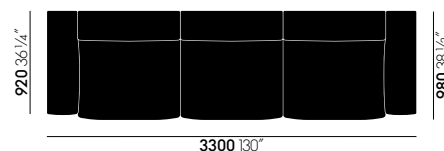

Three seater

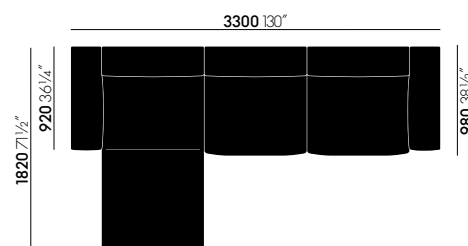

Three seater with Chaise Longue

All measurements are pursuant to EN 1335-1:2000

More detailed information is found in the chapter 'Explanation of measurements'.

Soft Modular Sofa

Seat: steel frame, wood construction with steel springs, polyurethane foam structure and visco cover.

Seat height: 380 mm (270 mm with applied load, measured in accordance with EN 1335-1:2000).

Armrests and backrest: wood construction with polyurethane foam structure and chamber cushion overlay (filling made of polyurethane foam rods and polyester fibres).

Covers: removable.

Throw cushions: foam cube and ball fibre filling.

Neck cushion: polypropylene pellet filling.

Glides: plastic glides with levelling adjustment.

Ottoman structure: wood construction, steel springs and polyurethane foam structure with visco cover.

Note: the designations ,left' and ,right' refer to the perspective when viewing the sofa from the front.

Note: corner elements are not suited as end units.

Note: the armrests are available in high or low versions.

Soft Modular Sofa

Jasper Morrison, 2016

vitra.

with VAT in SEK*	F40 Laser RE Mello	F60 Olimpo Volo	F80 Cosy 2 Dumet Iroko 2 Linho Savana Tress	F100 Aura Nubia Reed	F120 Credo Track	L20 Leather	L50 Leather Premium F	
Lateral part								
Lateral part, right	210 460 00	28.900,00	30.400,00	32.900,00	34.500,00	36.400,00	42.500,00	61.700,00
Lateral part, left	210 461 00	28.900,00	30.400,00	32.900,00	34.500,00	36.400,00	42.500,00	61.700,00
Central part								
Central part	210 462 00	25.400,00	25.800,00	27.300,00	28.900,00	29.900,00	35.000,00	47.000,00
Platform								
Platform, right	210 494 00	20.600,00	22.000,00	22.800,00	23.600,00	25.400,00	28.900,00	39.400,00
Platform, left	210 495 00	20.600,00	22.000,00	22.800,00	23.600,00	25.400,00	28.900,00	39.400,00
Platform, central	210 496 00	20.600,00	22.000,00	22.800,00	23.600,00	25.400,00	28.900,00	39.400,00
Corner part								
Corner element, right	210 463 00	31.300,00	33.400,00	35.000,00	36.400,00	38.200,00	45.000,00	61.700,00
Corner element, left	210 464 00	31.300,00	33.400,00	35.000,00	36.400,00	38.200,00	45.000,00	61.700,00
Chaise Longue								
Chaise Longue, right	210 465 00	39.400,00	41.900,00	44.300,00	47.000,00	49.500,00	57.800,00	80.700,00
Chaise Longue, left	210 466 00	39.400,00	41.900,00	44.300,00	47.000,00	49.500,00	57.800,00	80.700,00
Ottoman								
Ottoman	210 467 00	16.000,00	17.500,00	18.300,00	19.000,00	19.800,00	23.600,00	31.300,00
Cushions								
Cushion 30 x 40 cm	210 470 00	1.140,00	1.460,00	1.600,00	1.750,00	2.090,00	2.450,00	3.550,00
Cushion 40 x 40 cm	210 471 00	1.300,00	1.600,00	1.750,00	1.900,00	2.200,00	2.590,00	4.150,00
Cushion 50 x 50 cm	210 472 00	1.460,00	1.750,00	2.090,00	2.200,00	2.590,00	3.000,00	5.050,00
Neck cushion, short	210 468 00	1.000,00	1.300,00	1.460,00	1.750,00	1.900,00	2.200,00	3.550,00
Neck cushion, long	210 469 00	1.900,00	2.200,00	2.750,00	3.250,00	3.550,00	4.250,00	6.600,00

Soft Modular Sofa

Jasper Morrison, 2016

vitra.

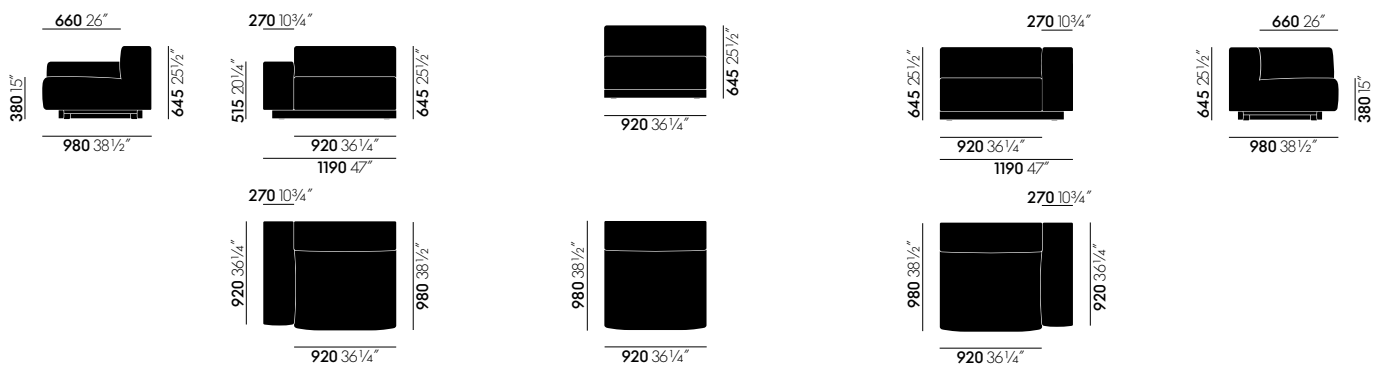

Side element left - low armrest

Central element

Side element right - high armrest

All measurements are pursuant to EN 1335-1:2000
More detailed information is found in the chapter 'Explanation of measurements'.

Soft Modular Sofa side elements

	Article no.	without VAT in SEK*	with VAT in SEK*
Lateral part right	210 460 00		
Fabric F40		23.120,00	28.900,00
Fabric F60		24.320,00	30.400,00
Fabric F80		26.320,00	32.900,00
Fabric F100		27.600,00	34.500,00
Fabric F120		29.120,00	36.400,00
Leather L20		34.000,00	42.500,00
Leather L50		49.360,00	61.700,00
Lateral part left	210 461 00		
Fabric F40		23.120,00	28.900,00
Fabric F60		24.320,00	30.400,00
Fabric F80		26.320,00	32.900,00
Fabric F100		27.600,00	34.500,00
Fabric F120		29.120,00	36.400,00
Leather L20		34.000,00	42.500,00
Leather L50		49.360,00	61.700,00

Soft Modular Sofa central part

	Article no.	without VAT in SEK*	with VAT in SEK*
Central part	210 462 00		
Fabric F40		20.320,00	25.400,00
Fabric F60		20.640,00	25.800,00
Fabric F80		21.840,00	27.300,00
Fabric F100		23.120,00	28.900,00
Fabric F120		23.920,00	29.900,00
Leather L20		28.000,00	35.000,00
Leather L50		37.600,00	47.000,00

Fabric F40	Fabric F60	Fabric F80	Fabric F100	Fabric F120	Leather L20	Leather L50	Height armrests
. Laser RE . Mello	. Olimpo . Volo	. Cosy 2 . Dumet . Iroko 2 . Linho . Savana . Tress	. Aura . Nubia . Reed	. Credo . Track	. Leather	. Leather Premium F	01 low 02 high

Soft Modular Sofa

Jasper Morrison, 2016

vitra.

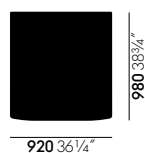
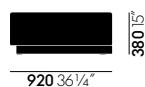

Platform left

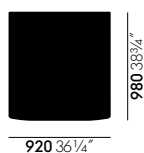
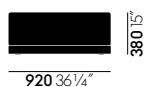

Platform central

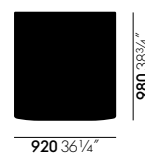

Platform right

All measurements are pursuant to EN 1335-1:2000
More detailed information is found in the chapter 'Explanation of measurements'.

Soft Modular Sofa platform

	Article no.	without VAT in SEK*	with VAT in SEK*
Platform right	210 494 00		
Fabric F40		16.480,00	20.600,00
Fabric F60		17.600,00	22.000,00
Fabric F80		18.240,00	22.800,00
Fabric F100		18.880,00	23.600,00
Fabric F120		20.320,00	25.400,00
Leather L20		23.120,00	28.900,00
Leather L50		31.520,00	39.400,00
Platform left	210 495 00		
Fabric F40		16.480,00	20.600,00
Fabric F60		17.600,00	22.000,00
Fabric F80		18.240,00	22.800,00
Fabric F100		18.880,00	23.600,00
Fabric F120		20.320,00	25.400,00
Leather L20		23.120,00	28.900,00
Leather L50		31.520,00	39.400,00
Platform central	210 496 00		
Fabric F40		16.480,00	20.600,00
Fabric F60		17.600,00	22.000,00
Fabric F80		18.240,00	22.800,00
Fabric F100		18.880,00	23.600,00
Fabric F120		20.320,00	25.400,00
Leather L20		23.120,00	28.900,00
Leather L50		31.520,00	39.400,00

Soft Modular Sofa

Jasper Morrison, 2016

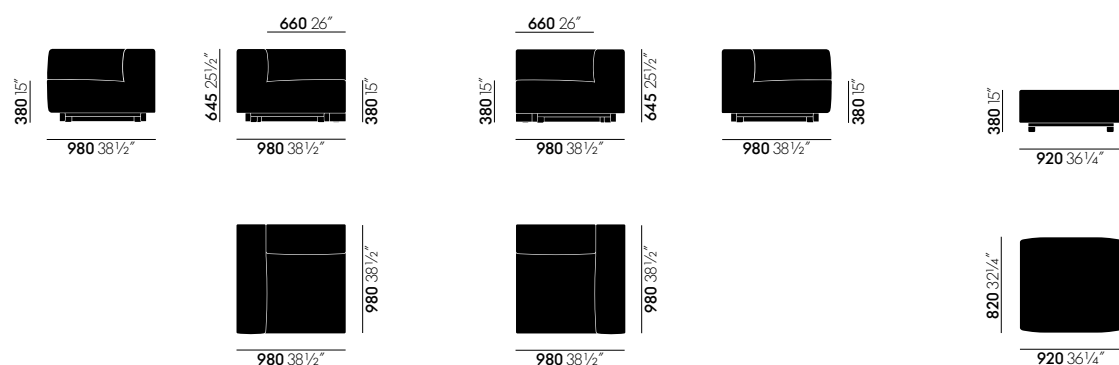

Corner element left

Corner element right

Ottoman

All measurements are pursuant to EN 1335-1:2000
 More detailed information is found in the chapter 'Explanation of measurements'.

Soft Modular Sofa corner parts

	Article no.	without VAT in SEK*	with VAT in SEK*
Corner element right	210 463 00		
Fabric F40		25.040,00	31.300,00
Fabric F60		26.720,00	33.400,00
Fabric F80		28.000,00	35.000,00
Fabric F100		29.120,00	36.400,00
Fabric F120		30.560,00	38.200,00
Leather L20		36.000,00	45.000,00
Leather L50		49.360,00	61.700,00
Corner element left	210 464 00		
Fabric F40		25.040,00	31.300,00
Fabric F60		26.720,00	33.400,00
Fabric F80		28.000,00	35.000,00
Fabric F100		29.120,00	36.400,00
Fabric F120		30.560,00	38.200,00
Leather L20		36.000,00	45.000,00
Leather L50		49.360,00	61.700,00

Soft Modular Sofa Ottoman

	Article no.	without VAT in SEK*	with VAT in SEK*
Ottoman	210 467 00		
Fabric F40		12.800,00	16.000,00
Fabric F60		14.000,00	17.500,00
Fabric F80		14.640,00	18.300,00
Fabric F100		15.200,00	19.000,00
Fabric F120		15.840,00	19.800,00
Leather L20		18.880,00	23.600,00
Leather L50		25.040,00	31.300,00

Fabric F40	Fabric F60	Fabric F80	Fabric F100	Fabric F120	Leather L20	Leather L50	Height armrests
. Laser RE . Mello	. Olimpo . Volo	. Cosy 2 . Dumet . Iroko 2 . Linho . Savana . Tress	. Aura . Nubia . Reed	. Credo . Track	. Leather	. Leather Premium F	01 low 02 high

Soft Modular Sofa

Jasper Morrison, 2016

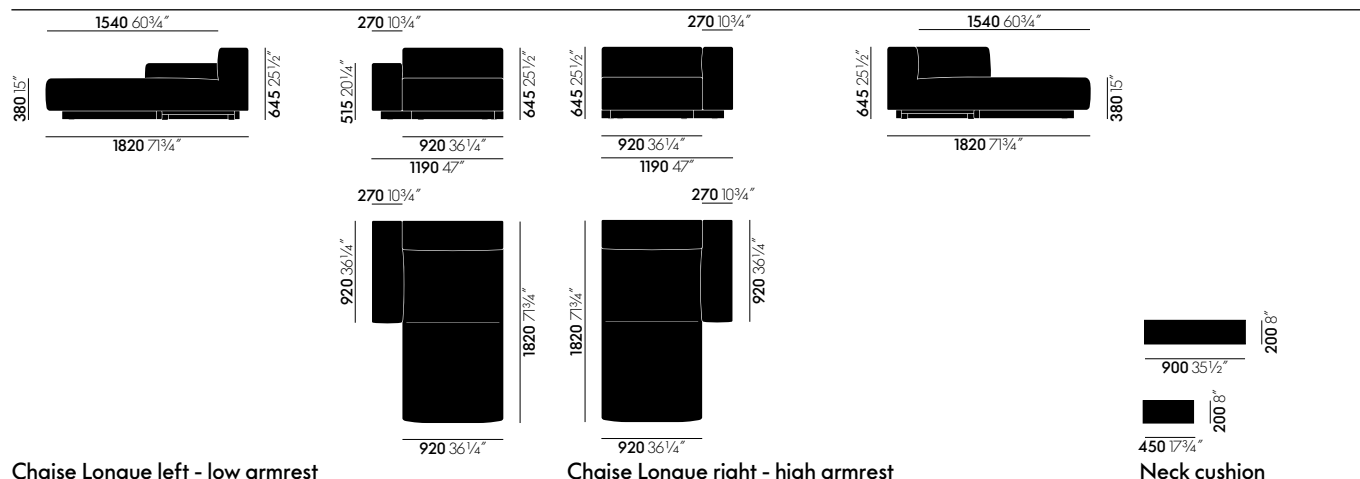

Chaise Longue left - low armrest

Chaise Longue right - high armrest

Neck cushion

All measurements are pursuant to EN 1335-1:2000

More detailed information is found in the chapter 'Explanation of measurements'.

Soft Modular Sofa Chaises Longues

	Article no.	without VAT in SEK*	with VAT in SEK*
Chaise Longue right	210 465 00		
Fabric F40		31.520,00	39.400,00
Fabric F60		33.520,00	41.900,00
Fabric F80		35.440,00	44.300,00
Fabric F100		37.600,00	47.000,00
Fabric F120		39.600,00	49.500,00
Leather L20		46.240,00	57.800,00
Leather L50		64.560,00	80.700,00
Chaise Longue left	210 466 00		
Fabric F40		31.520,00	39.400,00
Fabric F60		33.520,00	41.900,00
Fabric F80		35.440,00	44.300,00
Fabric F100		37.600,00	47.000,00
Fabric F120		39.600,00	49.500,00
Leather L20		46.240,00	57.800,00
Leather L50		64.560,00	80.700,00

Soft Modular Sofa neck support cushions

	Article no.	without VAT in SEK*	with VAT in SEK*
Neck cushion, short	210 468 00		
Fabric F40		800,00	1.000,00
Fabric F60		1.040,00	1.300,00
Fabric F80		1.168,00	1.460,00
Fabric F100		1.400,00	1.750,00
Fabric F120		1.520,00	1.900,00
Leather L20		1.760,00	2.200,00
Leather L50		2.840,00	3.550,00
Neck cushion, long	210 469 00		
Fabric F40		1.520,00	1.900,00
Fabric F60		1.760,00	2.200,00
Fabric F80		2.200,00	2.750,00
Fabric F100		2.600,00	3.250,00
Fabric F120		2.840,00	3.550,00
Leather L20		3.400,00	4.250,00
Leather L50		5.280,00	6.600,00

Soft Modular Sofa

Jasper Morrison, 2016

vitra.



Decorative cushions

All measurements are pursuant to EN 1335-1:2000
More detailed information is found in the chapter 'Explanation of measurements'.

Soft Modular Sofa cushions

	Article no.	without VAT in SEK*	with VAT in SEK*
Cushion 30 x 40 cm	210 470 00		
Fabric F40		912,00	1.140,00
Fabric F60		1.168,00	1.460,00
Fabric F80		1.280,00	1.600,00
Fabric F100		1.400,00	1.750,00
Fabric F120		1.672,00	2.090,00
Leather L20		1.960,00	2.450,00
Leather L50		2.840,00	3.550,00
Cushion 40 x 40 cm	210 471 00		
Fabric F40		1.040,00	1.300,00
Fabric F60		1.280,00	1.600,00
Fabric F80		1.400,00	1.750,00
Fabric F100		1.520,00	1.900,00
Fabric F120		1.760,00	2.200,00
Leather L20		2.072,00	2.590,00
Leather L50		3.320,00	4.150,00
Cushion 50 x 50 cm	210 472 00		
Fabric F40		1.168,00	1.460,00
Fabric F60		1.400,00	1.750,00
Fabric F80		1.672,00	2.090,00
Fabric F100		1.760,00	2.200,00
Fabric F120		2.072,00	2.590,00
Leather L20		2.400,00	3.000,00
Leather L50		4.040,00	5.050,00

Fabric F40	Fabric F60	Fabric F80	Fabric F100	Fabric F120	Leather L20	Leather L50	Height armrests
. Laser RE . Mello	. Olimpo . Volo	. Cosy 2 . Dumet . Iroko 2 . Linho . Savana . Tress	. Aura . Nubia . Reed	. Credo . Track	. Leather	. Leather Premium F	01 low 02 high

Suita

Antonio Citterio, 2010/2019

vitra.



Suita Sofa 3-Seater, back cushions: Classic

Characteristics:

- firm and soft upholstery
- Fabric and leather
- 3-Seater with 2 seat cushions and 2 back cushions



Suita Sofa 3-Seater, back cushions: pointed cushions

Characteristics:

- Soft upholstery
- Fabric and leather
- 3-Seater with 2 seat cushions and 5 back cushions



Suita Sofa 3-Seater, tufted

Characteristics:

- Soft upholstery
- Fabric, no leather
- 3-Seater with one one-piece seat cushion and 3 back cushions
- Daybed available

Suita

Antonio Citterio, 2010/2019

Suita

Legs: die-cast aluminium, polished or powder-coated.

Body: webbed metal frame with moulded polyurethane foam.

Classic seat cushions, firm: polyurethane foam and polyester fibre.

Classic seat cushions, soft and tufted: polyurethane foam core and chamber cushion overlay (filled with polyurethane foam lozenges, latex and a mix of goose feathers and down).

Seat height: 430 mm (315 mm with applied load, measured in accordance with EN 1335-1:2000).

Classic back cushions, firm: chamber cushions filled with polyurethane chips and feathers.

Classic back cushions, soft: chamber cushions filled with polyurethane foam cubes and feathers.

Tufted back cushions: chamber cushions filled with polyurethane foam cubes and ball fibres.

Pointed cushions 40 x 40 cm and 40 x 60 cm: filled with 100% feathers.

Pointed cushions 60 x 60 cm and 60 x 80 cm: filled with polyurethane foam lozenges and feathers.

Bolsters: filled with polyurethane foam lozenges and feathers.

Armrest cushions: latex and siliconised fibres.

Covers: removable.

Glides: non-slip.

Head section: moulded polyurethane foam with metal frame.

Shelf: aluminium profile, powder-coated die-cast zinc with linoleum inlay.

Daybed: metal frame with wooden panel, polyurethane foam, soft seat cushion.

Covers: removable.

Glides: non-slip.

Ottoman, firm: wooden panel, polyurethane foam, firm seat cushion.

Ottoman, soft and tufted: wooden panel, polyurethane foam core and chamber cushion overlay (filled with polyurethane foam lozenges, latex and a mix of goose feathers and down).

Covers: removable.

Glides (for Suita Ottoman and Suita Club Armchair): glides for carpet or felt glides for hard floors.

Note: the designations ‚left‘ and ‚right‘ refer to the perspective when viewing the sofa from the front.

Note: ripples and indentations from sitting (pressure marks) and partially visible outlines of the chamber cushions are characteristic of high-quality, soft upholstery in combination with a removable cover and can be more or less pronounced, depending on the selected cover material. To retain the fullness and shape of your sofa, cushions should be regularly shaken and plumped.

Application: soft upholstery version recommended for domestic use only.

Fabric F40	Fabric F60	Fabric F80	Fabric F100	Fabric F120	Leather L20	Leather L50	Leather L60
· Laser RE · Mello	· Olimpo · Volo	· Corsaro · Cosy 2 (cross stitch) · Dumet · Iroko 2 · Linho · Savana	· Nubia · Reed	· Credo	· Leather	· Leather Premium F	· Leather Natural F

Base	Tray	Tray inlay
03 polished aluminium 30 basic dark powder-coated (smooth)	30 basic dark powder-coated (smooth)	01 pebble 02 charcoal

Suita, back cushions Classic

Antonio Citterio, 2010/2019



Suita Sofa, back cushion Classic

with VAT in SEK*

	F40 Laser RE Mello	F60 Olimpo Volo	F80 Corsaro Cosy 2 Dumet Iroko 2 Linho Savana	F100 Nubia Reed	F120 Credo	L20 Leather	L60 Leather Premium F	L60 Leather Natural F
Suita Sofa 2-Seater	210 593 00							
Upholstery firm	52.200,00	56.100,00	59.700,00	63.600,00	67.400,00	79.100,00	103.800,00	135.900,00
Surcharges								
Upholstery soft	4.250,00	4.250,00	4.250,00	4.250,00	4.250,00	4.250,00	4.250,00	4.250,00
+ Head Section	13.700,00	14.800,00	16.000,00	17.200,00	18.300,00	21.900,00	29.300,00	40.400,00
+ Tray	14.900,00	14.900,00	14.900,00	14.900,00	14.900,00	14.900,00	14.900,00	14.900,00

Suita Sofa 2-Seater open

210 594 00

Upholstery firm	50.700,00	54.000,00	57.300,00	60.800,00	64.100,00	77.600,00	99.100,00	127.400,00
Surcharges								
Upholstery soft	4.250,00	4.250,00	4.250,00	4.250,00	4.250,00	4.250,00	4.250,00	4.250,00
+ Tray	14.900,00	14.900,00	14.900,00	14.900,00	14.900,00	14.900,00	14.900,00	14.900,00

Suita Sofa 3-Seater

210 595 00

Upholstery firm	64.800,00	69.100,00	73.700,00	77.900,00	82.400,00	94.400,00	124.900,00	165.600,00
Surcharges								
Upholstery soft	5.250,00	5.250,00	5.250,00	5.250,00	5.250,00	5.250,00	5.250,00	5.250,00
+ Head Section	14.600,00	16.000,00	17.500,00	18.900,00	20.300,00	23.000,00	31.300,00	42.800,00
+ Tray	17.000,00	17.000,00	17.000,00	17.000,00	17.000,00	17.000,00	17.000,00	17.000,00

Suita Sofa 3-Seater open

210 596 00

Upholstery firm	63.400,00	67.700,00	71.700,00	76.000,00	80.200,00	93.000,00	120.000,00	155.700,00
Surcharges								
Upholstery soft	5.250,00	5.250,00	5.250,00	5.250,00	5.250,00	5.250,00	5.250,00	5.250,00
+ Tray	17.000,00	17.000,00	17.000,00	17.000,00	17.000,00	17.000,00	17.000,00	17.000,00

Suita, back cushions Classic

Antonio Citterio, 2010/2019

Suita Sofa, back cushion Classic

with VAT in SEK*

	F40 Laser RE Mello	F60 Olimpo Volo	F80 Corsaro Cosy 2 Dumet Iroko 2 Linho Savana	F100 Nubia Reed	F120 Credo	L20 Leather	L50 Leather Premium F	L60 Leather Natural F
--	--------------------------	-----------------------	---	-----------------------	---------------	----------------	-----------------------------	-----------------------------

Suita Sofa Chaise Longue small 210 597 00

Upholstery firm	47.800,00	50.600,00	53.700,00	56.800,00	59.800,00	72.000,00	94.100,00	123.000,00
Surcharges								
Upholstery soft	4.250,00	4.250,00	4.250,00	4.250,00	4.250,00	4.250,00	4.250,00	4.250,00
+ Head Section	9.000,00	9.550,00	10.000,00	10.700,00	11.200,00	12.300,00	16.400,00	22.300,00

Suita Sofa Chaise Longue large 210 598 00

Upholstery firm	70.900,00	74.700,00	78.600,00	82.700,00	86.600,00	95.600,00	123.800,00	160.800,00
Surcharges								
Upholstery soft	5.250,00	5.250,00	5.250,00	5.250,00	5.250,00	5.250,00	5.250,00	5.250,00
+ Head Section	9.000,00	9.550,00	10.000,00	10.700,00	11.200,00	12.300,00	16.400,00	22.300,00

Suita Ottoman 210 599 00

Upholstery firm	19.600,00	20.500,00	21.500,00	22.700,00	23.500,00	26.600,00	35.600,00	48.100,00
-----------------	-----------	-----------	-----------	-----------	-----------	-----------	-----------	-----------

Suita Cushions

Cushion for head section	210 615 00	1.130,00	1.280,00	1.470,00	1.640,00	1.790,00	2.350,00	3.350,00	4.750,00
Armrest cushion 59 x 15 x 27 cm	210 600 00	2.550,00	3.190,00	3.890,00	4.650,00	5.290,00	5.390,00	8.190,00	12.000,00
Armrest cushion 59x15x27 cm (set of 2)	210 648 00	4.250,00	4.900,00	5.600,00	6.450,00	7.100,00	10.900,00	16.200,00	23.900,00
Roll cushions 54 x Ø16 cm	210 616 00	1.430,00	1.680,00	1.910,00	2.150,00	2.450,00	2.750,00	3.850,00	5.390,00

Suita, back cushions Classic

Antonio Citterio, 2010/2019

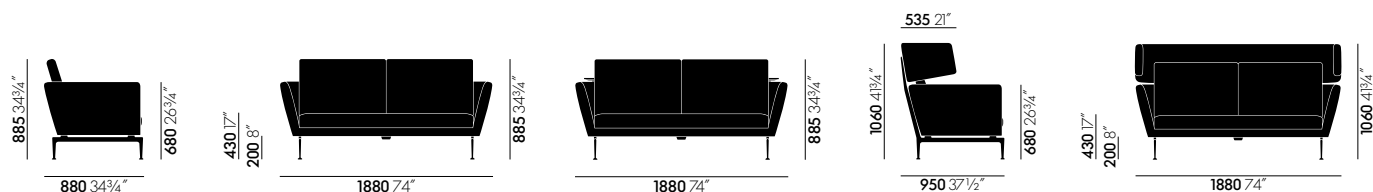

Suita Sofa 2-Seater

Suita Sofa 2-Seater
with tray

Suita Sofa 2-Seater with head section

Suita Sofa 2-Seater, classic

	Article no.	without VAT in SEK*	with VAT in SEK*
		210 593 00	
Fabric F40		41.760,00	52.200,00
Fabric F60		44.880,00	56.100,00
Fabric F80		47.760,00	59.700,00
Fabric F100		50.880,00	63.600,00
Fabric F120		53.920,00	67.400,00
Leather L20		63.280,00	79.100,00
Leather L50		83.040,00	103.800,00
Leather L60		108.720,00	135.900,00
Surcharges upholstery			
Comfort soft	02	3.400,00	4.250,00
Surcharges shelf			
basic dark		11.920,00	14.900,00
Surcharges head section			
Fabric F40		10.960,00	13.700,00
Fabric F60		11.840,00	14.800,00
Fabric F80		12.800,00	16.000,00
Fabric F100		13.760,00	17.200,00
Fabric F120		14.640,00	18.300,00
Leather L20		17.520,00	21.900,00
Leather L50		23.440,00	29.300,00
Leather L60		32.320,00	40.400,00

Fabric F40	Fabric F60	Fabric F80	Fabric F100	Fabric F120	Leather L20	Leather L50	Leather L60
· Laser RE · Mello	· Olimpo · Volo	· Corsaro · Cosy 2 (cross stitch) · Dumet · Iroko 2 · Linho · Savana	· Nubia · Reed	· Credo	· Leather	· Leather Premium F	· Leather Natural F

Base	Tray	Tray inlay
03 polished aluminium 30 basic dark powder-coated (smooth)	30 basic dark powder-coated (smooth)	01 pebble 02 charcoal

Suita, back cushions Classic

Antonio Citterio, 2010/2019

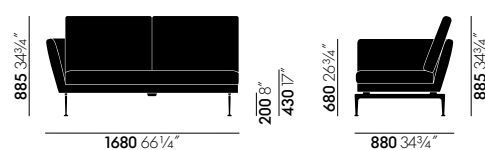

Suita Sofa 2-Seater, open, armrest left

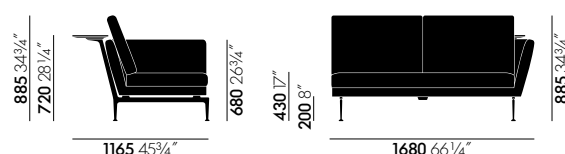

Suita Sofa 2-Seater, open, armrest right, with tray

Suita Sofa 2-Seater open, classic

	Article no.	without VAT in SEK*	with VAT in SEK*
	210 594 00		
Fabric F40		40.560,00	50.700,00
Fabric F60		43.200,00	54.000,00
Fabric F80		45.840,00	57.300,00
Fabric F100		48.640,00	60.800,00
Fabric F120		51.280,00	64.100,00
Leather L20		62.080,00	77.600,00
Leather L50		79.280,00	99.100,00
Leather L60		101.920,00	127.400,00
Surcharges upholstery			
Comfort soft	02	3.400,00	4.250,00
Surcharges tray			
basic dark		11.920,00	14.900,00

Fabric F40	Fabric F60	Fabric F80	Fabric F100	Fabric F120	Leather L20	Leather L50	Leather L60
· Laser RE · Mello	· Olimpo · Volo	· Corsaro · Cosy 2 (cross stitch) · Dumet · Ireko 2 · Linho · Savana	· Nubia · Reed	· Credo	· Leather	· Leather Premium F	· Leather Natural F

Base	Tray	Tray inlay
03 polished aluminium 30 basic dark powder-coated (smooth)	30 basic dark powder-coated (smooth)	01 pebble 02 charcoal

Suita, back cushions Classic

Antonio Citterio, 2010/2019

vitra.

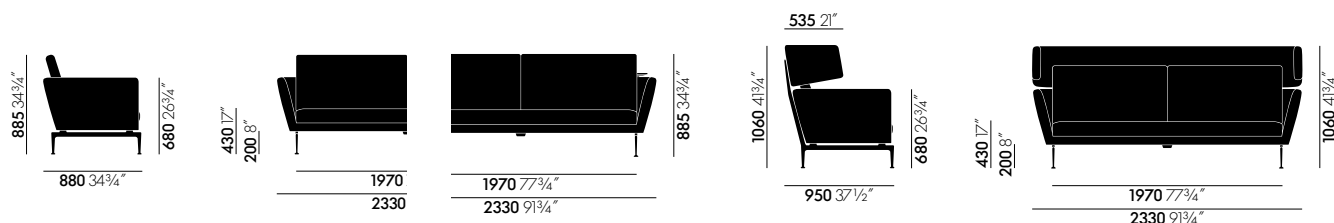

Suita Sofa 3-Seater

Suita Sofa 3-Seater with tray

Suita Sofa 3-Seater with head section

Suita Sofa 3-seater, classic

	Article no.	without VAT in SEK*	with VAT in SEK*
		210 595 00	
Fabric F40		51.840,00	64.800,00
Fabric F60		55.280,00	69.100,00
Fabric F80		58.960,00	73.700,00
Fabric F100		62.320,00	77.900,00
Fabric F120		65.920,00	82.400,00
Leather L20		75.520,00	94.400,00
Leather L50		99.920,00	124.900,00
Leather L60		132.480,00	165.600,00
Surcharges upholstery			
Comfort soft	02	4.200,00	5.250,00
Surcharges tray			
basic dark		13.600,00	17.000,00
Surcharges header section			
Fabric F40		11.680,00	14.600,00
Fabric F60		12.800,00	16.000,00
Fabric F80		14.000,00	17.500,00
Fabric F100		15.120,00	18.900,00
Fabric F120		16.240,00	20.300,00
Leather L20		18.400,00	23.000,00
Leather L50		25.040,00	31.300,00
Leather L60		34.240,00	42.800,00

Fabric F40	Fabric F60	Fabric F80	Fabric F100	Fabric F120	Leather L20	Leather L50	Leather L60
· Laser RE · Mello	· Olimpo · Volo	· Corsaro · Cosy 2 (cross stitch) · Dumet · Iroko 2 · Linho · Savana	· Nubia · Reed	· Credo	· Leather	· Leather Premium F	· Leather Natural F

Base	Tray	Tray inlay
03 polished aluminium 30 basic dark powder-coated (smooth)	30 basic dark powder-coated (smooth)	01 pebble 02 charcoal

Suita, back cushions Classic

Antonio Citterio, 2010/2019

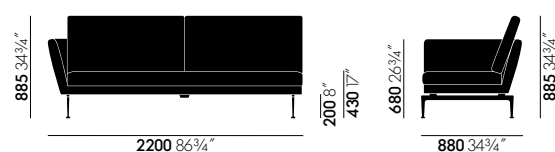

Suita Sofa 3-Seater, open, armrest left

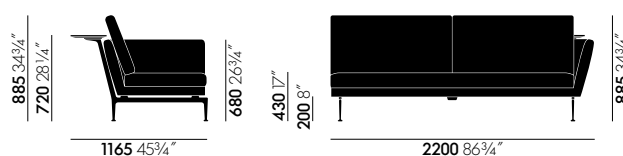

Suita Sofa 3-Seater, open, armrest right, with tray

Suita Sofa 3-Seater open, classic

	Article no.	without VAT in SEK*	with VAT in SEK*
		210 596 00	
Fabric F40		50.720,00	63.400,00
Fabric F60		54.160,00	67.700,00
Fabric F80		57.360,00	71.700,00
Fabric F100		60.800,00	76.000,00
Fabric F120		64.160,00	80.200,00
Leather L20		74.400,00	93.000,00
Leather L50		96.000,00	120.000,00
Leather L60		124.560,00	155.700,00
Surcharges upholstery			
Comfort soft	02	4.200,00	5.250,00
Surcharges tray			
basic dark		13.600,00	17.000,00

Fabric F40	Fabric F60	Fabric F80	Fabric F100	Fabric F120	Leather L20	Leather L50	Leather L60
· Laser RE · Mello	· Olimpo · Volo	· Corsaro · Cosy 2 (cross stitch) · Dumet · Iroko 2 · Linho · Savana	· Nubia · Reed	· Credo	· Leather	· Leather Premium F	· Leather Natural F

Base	Tray	Tray inlay
03 polished aluminium 30 basic dark powder-coated (smooth)	30 basic dark powder-coated (smooth)	01 pebble 02 charcoal

Suita, back cushions Classic

Antonio Citterio, 2010/2019

vitra.



Suita Chaise Longue small, left

Suita Chaise Longue small, right, with head section

Suita Chaise Longue small, classic

	Article no.	without VAT in SEK*	with VAT in SEK*
		210 597 00	
Fabric F40		38.240,00	47.800,00
Fabric F60		40.480,00	50.600,00
Fabric F80		42.960,00	53.700,00
Fabric F100		45.440,00	56.800,00
Fabric F120		47.840,00	59.800,00
Leather L20		57.600,00	72.000,00
Leather L50		75.280,00	94.100,00
Leather L60		98.400,00	123.000,00
Surcharges upholstery			
Comfort soft	02	3.400,00	4.250,00
Surcharges header section			
Fabric F40		7.200,00	9.000,00
Fabric F60		7.640,00	9.550,00
Fabric F80		8.000,00	10.000,00
Fabric F100		8.560,00	10.700,00
Fabric F120		8.960,00	11.200,00
Leather L20		9.840,00	12.300,00
Leather L50		13.120,00	16.400,00
Leather L60		17.840,00	22.300,00

Fabric F40	Fabric F60	Fabric F80	Fabric F100	Fabric F120	Leather L20	Leather L50	Leather L60
· Laser RE · Mello	· Olimpo · Volo	· Corsaro · Cosy 2 (cross stitch) · Dumet · Iroko 2 · Linho · Savana	· Nubia · Reed	· Credo	· Leather	· Leather Premium F	· Leather Natural F

Base

03 polished aluminium
30 basic dark powder-coated (smooth)

Suita, back cushions Classic

Antonio Citterio, 2010/2019

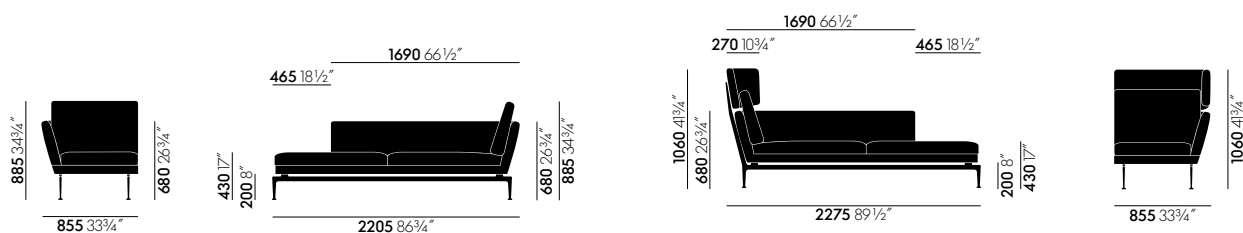

Suita Chaise Longue large, left

Suita Chaise Longue large, right, with head section

Suita Chaise Longue large, classic

	Article no.	without VAT in SEK*	with VAT in SEK*
	210 598 00		
Fabric F40		56.720,00	70.900,00
Fabric F60		59.760,00	74.700,00
Fabric F80		62.880,00	78.600,00
Fabric F100		66.160,00	82.700,00
Fabric F120		69.280,00	86.600,00
Leather L20		76.480,00	95.600,00
Leather L50		99.040,00	123.800,00
Leather L60		128.640,00	160.800,00
Surcharges upholstery			
Comfort soft	02	4.200,00	5.250,00
Surcharges header section			
Fabric F40		7.200,00	9.000,00
Fabric F60		7.640,00	9.550,00
Fabric F80		8.000,00	10.000,00
Fabric F100		8.560,00	10.700,00
Fabric F120		8.960,00	11.200,00
Leather L20		9.840,00	12.300,00
Leather L50		13.120,00	16.400,00
Leather L60		17.840,00	22.300,00

Fabric F40	Fabric F60	Fabric F80	Fabric F100	Fabric F120	Leather L20	Leather L50	Leather L60
· Laser RE · Mello	· Olimpo · Volo	· Corsaro · Cosy 2 (cross stitch) · Dumet · Iroko 2 · Linho · Savana	· Nubia · Reed	· Credo	· Leather	· Leather Premium F	· Leather Natural F

Base

03 polished aluminium
30 basic dark powder-coated (smooth)

Suita, back cushions Classic

Antonio Citterio, 2010/2019

vitra.



Suita Ottoman

Suita Ottoman	Article no.	without VAT in SEK*	with VAT in SEK*
	210 599 00		
Fabric F40		15.680,00	19.600,00
Fabric F60		16.400,00	20.500,00
Fabric F80		17.200,00	21.500,00
Fabric F100		18.160,00	22.700,00
Fabric F120		18.800,00	23.500,00
Leather L20		21.280,00	26.600,00
Leather L50		28.480,00	35.600,00
Leather L60		38.480,00	48.100,00

Fabric F40	Fabric F60	Fabric F80	Fabric F100	Fabric F120	Leather L20	Leather L50	Leather L60
· Laser RE · Mello	· Olimpo · Volo	· Corsaro · Cosy 2 (cross stitch) · Dumet · Ireko 2 · Linho · Savana	· Nubia · Reed	· Credo	· Leather	· Leather Premium F	· Leather Natural F

Base	Glides, Ottoman
03 polished aluminium 30 basic dark powder-coated (smooth)	04 glides for carpet 05 felt glides for hard floor

Suita, back cushions: pointed

Antonio Citterio, 2010/2019



Suita Sofa, back pointed cushion

with VAT in SEK*

	F40 Laser RE Mello	F60 Olimpo Volo	F80 Corsaro Cosy 2 Dumet Iroko 2 Linho Savana	F100 Nubia Reed	F120 Credo	L20 Leather	L50 Leather Premium F	L60 Leather Natural F
--	--------------------------	-----------------------	---	-----------------------	---------------	----------------	-----------------------------	-----------------------------

Suita Sofa 2-Seater 210 609 00

Upholstery soft	57.800,00	61.600,00	65.400,00	69.100,00	73.100,00	84.200,00	108.800,00	141.000,00
-----------------	-----------	-----------	-----------	-----------	-----------	-----------	------------	------------

Surcharges

+ Head Section	13.700,00	14.800,00	16.000,00	17.200,00	18.300,00	21.900,00	29.300,00	40.400,00
+ Tray	14.900,00	14.900,00	14.900,00	14.900,00	14.900,00	14.900,00	14.900,00	14.900,00

Suita Sofa 2-Seater open 210 610 00

Upholstery soft	56.600,00	59.900,00	63.400,00	66.700,00	70.400,00	83.300,00	104.700,00	133.000,00
-----------------	-----------	-----------	-----------	-----------	-----------	-----------	------------	------------

Surcharges

+ Tray	14.900,00	14.900,00	14.900,00	14.900,00	14.900,00	14.900,00	14.900,00	14.900,00
--------	-----------	-----------	-----------	-----------	-----------	-----------	-----------	-----------

Suita Sofa 3-Seater 210 611 00

Upholstery soft	71.300,00	75.700,00	80.200,00	84.400,00	89.000,00	100.700,00	131.300,00	171.700,00
-----------------	-----------	-----------	-----------	-----------	-----------	------------	------------	------------

Surcharges

+ Head Section	14.600,00	16.000,00	17.500,00	18.900,00	20.300,00	23.000,00	31.300,00	42.800,00
+ Tray	17.000,00	17.000,00	17.000,00	17.000,00	17.000,00	17.000,00	17.000,00	17.000,00

Suita Sofa 3-Seater open 210 612 00

Upholstery soft	69.600,00	74.100,00	78.200,00	82.300,00	86.600,00	99.000,00	126.000,00	161.800,00
-----------------	-----------	-----------	-----------	-----------	-----------	-----------	------------	------------

Surcharges

+ Tray	17.000,00	17.000,00	17.000,00	17.000,00	17.000,00	17.000,00	17.000,00	17.000,00
--------	-----------	-----------	-----------	-----------	-----------	-----------	-----------	-----------

Suita, back cushions: pointed

Antonio Citterio, 2010/2019

Suita Sofa, back pointed cushion

with VAT in SEK*

	F40 Laser RE Mello	F60 Olimpo Volo	F80 Corsaro Cosy 2 Dumet Iroko 2 Linho Savana	F100 Nubia Reed	F120 Credo	L20 Leather	L50 Leather Premium F	L60 Leather Natural F
--	--------------------------	-----------------------	---	-----------------------	---------------	----------------	-----------------------------	-----------------------------

Suita Sofa Chaise Longue small 210 613 00

Upholstery soft	52.200,00	55.400,00	58.300,00	61.400,00	64.600,00	76.800,00	98.600,00	127.700,00
Surcharges								
+ Head Section	9.000,00	9.550,00	10.000,00	10.700,00	11.200,00	12.300,00	16.400,00	22.300,00

Suita Sofa Chaise Longue large 210 614 00

Upholstery soft	77.700,00	81.500,00	85.400,00	89.300,00	93.100,00	101.800,00	129.900,00	166.900,00
Surcharges								
+ Head Section	9.000,00	9.550,00	10.000,00	10.700,00	11.200,00	12.300,00	16.400,00	22.300,00

Suita Ottoman 210 599 00

Upholstery firm	19.600,00	20.500,00	21.500,00	22.700,00	23.500,00	26.600,00	35.600,00	48.100,00
-----------------	-----------	-----------	-----------	-----------	-----------	-----------	-----------	-----------

Suita Cushions

Cushion for head section	210 615 00	1.130,00	1.280,00	1.470,00	1.640,00	1.790,00	2.350,00	3.350,00	4.750,00
Armrest cushion 59 x 15 x 27 cm	210 600 00	2.550,00	3.190,00	3.890,00	4.650,00	5.290,00	5.390,00	8.190,00	12.000,00
Armrest cushion 59x15x27 cm (set of 2)	210 648 00	4.250,00	4.900,00	5.600,00	6.450,00	7.100,00	10.900,00	16.200,00	23.900,00
Roll cushions 54 x Ø16 cm	210 616 00	1.430,00	1.680,00	1.910,00	2.150,00	2.450,00	2.750,00	3.850,00	5.390,00
Pointed cushion 40 x 40 cm	210 617 00	930,00	1.130,00	1.330,00	1.530,00	1.740,00	2.200,00	3.250,00	4.590,00
Pointed cushion 40 x 60 cm	210 618 00	1.570,00	1.840,00	2.150,00	2.490,00	2.790,00	3.790,00	5.050,00	6.750,00
Pointed cushion 60 x 60 cm	210 619 00	1.890,00	2.200,00	2.550,00	2.790,00	3.150,00	4.590,00	5.790,00	7.490,00
Pointed cushion 80 x 60 cm	210 620 00	2.790,00	3.290,00	3.790,00	4.390,00	4.790,00	6.450,00	7.890,00	10.000,00

Suita, back cushions: pointed

Antonio Citterio, 2010/2019

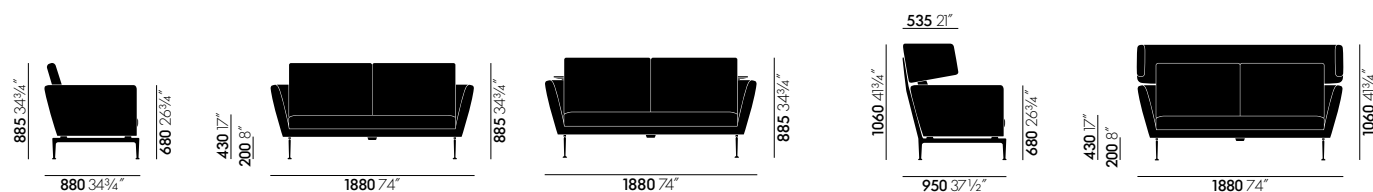

Suita Sofa 2-Seater

Suita Sofa 2-Seater
with tray

Suita Sofa 2-Seater with head section

Suita Sofa 2-Seater, pointed cushions

	Article no.	without VAT in SEK*	with VAT in SEK*
	210 609 00		
Fabric F40		46.240,00	57.800,00
Fabric F60		49.280,00	61.600,00
Fabric F80		52.320,00	65.400,00
Fabric F100		55.280,00	69.100,00
Fabric F120		58.480,00	73.100,00
Leather L20		67.360,00	84.200,00
Leather L50		87.040,00	108.800,00
Leather L60		112.800,00	141.000,00
Surcharges tray			
basic dark		11.920,00	14.900,00
Surcharges header section			
Fabric F40		10.960,00	13.700,00
Fabric F60		11.840,00	14.800,00
Fabric F80		12.800,00	16.000,00
Fabric F100		13.760,00	17.200,00
Fabric F120		14.640,00	18.300,00
Leather L20		17.520,00	21.900,00
Leather L50		23.440,00	29.300,00
Leather L60		32.320,00	40.400,00

Fabric F40	Fabric F60	Fabric F80	Fabric F100	Fabric F120	Leather L20	Leather L50	Leather L60
· Laser RE · Mello	· Olimpo · Volo	· Corsaro · Cosy 2 (cross stitch) · Dumet · Iroko 2 · Linho · Savana	· Nubia · Reed	· Credo	· Leather	· Leather Premium F	· Leather Natural F

Base	Tray	Tray inlay
03 polished aluminium 30 basic dark powder-coated (smooth)	30 basic dark powder-coated (smooth)	01 pebble 02 charcoal

Suita, back cushions: pointed

Antonio Citterio, 2010/2019

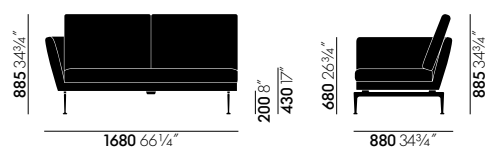

Suita Sofa 2-Seater, open, armrest left

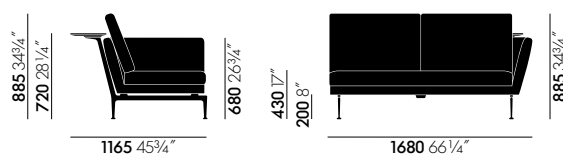

Suita Sofa 2-Seater, open, armrest right, with tray

Suita Sofa 2-Seater open, pointed cushions

	Article no.	without VAT in SEK*	with VAT in SEK*
	210 610 00		
Fabric F40		45.280,00	56.600,00
Fabric F60		47.920,00	59.900,00
Fabric F80		50.720,00	63.400,00
Fabric F100		53.360,00	66.700,00
Fabric F120		56.320,00	70.400,00
Leather L20		66.640,00	83.300,00
Leather L50		83.760,00	104.700,00
Leather L60		106.400,00	133.000,00
Surcharges tray			
basic dark		11.920,00	14.900,00

Fabric F40	Fabric F60	Fabric F80	Fabric F100	Fabric F120	Leather L20	Leather L50	Leather L60
· Laser RE · Mello	· Olimpo · Volo	· Corsaro · Cosy 2 (cross stitch) · Dumet · Ireko 2 · Linho · Savana	· Nubia · Reed	· Credo	· Leather	· Leather Premium F	· Leather Natural F

Base	Tray	Tray inlay
03 polished aluminium 30 basic dark powder-coated (smooth)	30 basic dark powder-coated (smooth)	01 pebble 02 charcoal

Suita, back cushions: pointed

Antonio Citterio, 2010/2019

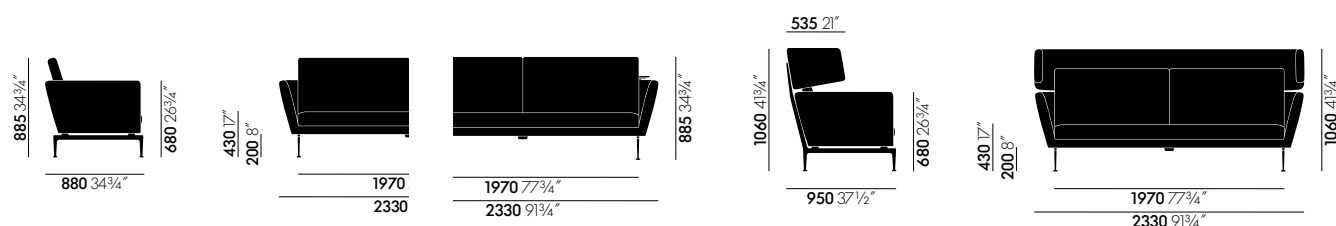

Suita Sofa 3-Seater

Suita Sofa 3-Seater with tray

Suita Sofa 3-Seater with head section

Suita Sofa 3-Seater, pointed cushions

	Article no.	without VAT in SEK*	with VAT in SEK*
	210 611 00		
Fabric F40		57.040,00	71.300,00
Fabric F60		60.560,00	75.700,00
Fabric F80		64.160,00	80.200,00
Fabric F100		67.520,00	84.400,00
Fabric F120		71.200,00	89.000,00
Leather L20		80.560,00	100.700,00
Leather L50		105.040,00	131.300,00
Leather L60		137.360,00	171.700,00
Surcharges tray			
basic dark		13.600,00	17.000,00
Surcharges header section			
Fabric F40		11.680,00	14.600,00
Fabric F60		12.800,00	16.000,00
Fabric F80		14.000,00	17.500,00
Fabric F100		15.120,00	18.900,00
Fabric F120		16.240,00	20.300,00
Leather L20		18.400,00	23.000,00
Leather L50		25.040,00	31.300,00
Leather L60		34.240,00	42.800,00

Fabric F40	Fabric F60	Fabric F80	Fabric F100	Fabric F120	Leather L20	Leather L50	Leather L60
· Laser RE · Mello	· Olimpo · Volo	· Corsaro · Cosy 2 (cross stitch) · Dumet · Iroko 2 · Linho · Savana	· Nubia · Reed	· Credo	· Leather	· Leather Premium F	· Leather Natural F

Base	Tray	Tray inlay
03 polished aluminium 30 basic dark powder-coated (smooth)	30 basic dark powder-coated (smooth)	01 pebble 02 charcoal

Suita, back cushions: pointed

Antonio Citterio, 2010/2019

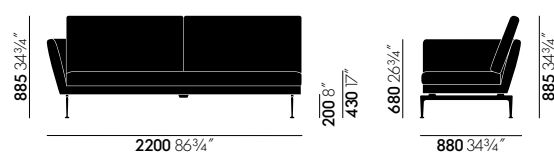

Suita Sofa 3-Seater, open, armrest left

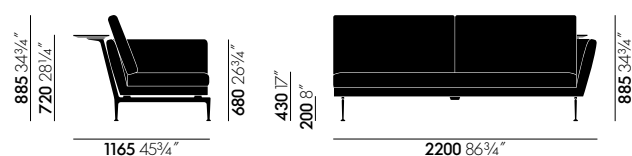

Suita Sofa 3-Seater, open, armrest right, with tray

Suita Sofa 3-Seater open, pointed cushions

	Article no.	without VAT in SEK*	with VAT in SEK*
	210 612 00		
Fabric F40		55.680,00	69.600,00
Fabric F60		59.280,00	74.100,00
Fabric F80		62.560,00	78.200,00
Fabric F100		65.840,00	82.300,00
Fabric F120		69.280,00	86.600,00
Leather L20		79.200,00	99.000,00
Leather L50		100.800,00	126.000,00
Leather L60		129.440,00	161.800,00
Surcharges tray			
basic dark		13.600,00	17.000,00

Fabric F40	Fabric F60	Fabric F80	Fabric F100	Fabric F120	Leather L20	Leather L50	Leather L60
· Laser RE	· Olimpo	· Corsaro	· Nubia	· Credo	· Leather	· Leather Premium F	· Leather Natural F
· Mello	· Volo	· Cosy 2 (cross stitch)	· Reed				
		· Dumet					
		· Iroko 2					
		· Linho					
		· Savana					

Base	Tray	Tray inlay
03 polished aluminium	30 basic dark powder-coated (smooth)	01 pebble
30 basic dark powder-coated (smooth)		02 charcoal

Suita, back cushions: pointed

Antonio Citterio, 2010/2019



Suita Chaise Longue small, left

Suita Chaise Longue small, right, with head section

Suita Chaise Longue small, pointed cushions

	Article no.	without VAT in SEK*	with VAT in SEK*
	210 613 00		
Fabric F40		41.760,00	52.200,00
Fabric F60		44.320,00	55.400,00
Fabric F80		46.640,00	58.300,00
Fabric F100		49.120,00	61.400,00
Fabric F120		51.680,00	64.600,00
Leather L20		61.440,00	76.800,00
Leather L50		78.880,00	98.600,00
Leather L60		102.160,00	127.700,00
Surcharges header section			
Fabric F40		7.200,00	9.000,00
Fabric F60		7.640,00	9.550,00
Fabric F80		8.000,00	10.000,00
Fabric F100		8.560,00	10.700,00
Fabric F120		8.960,00	11.200,00
Leather L20		9.840,00	12.300,00
Leather L50		13.120,00	16.400,00
Leather L60		17.840,00	22.300,00

Fabric F40	Fabric F60	Fabric F80	Fabric F100	Fabric F120	Leather L20	Leather L50	Leather L60
· Laser RE · Mello	· Olimpo · Volo	· Corsaro · Cosy 2 (cross stitch) · Dumet · Iroko 2 · Linho · Savana	· Nubia · Reed	· Credo	· Leather	· Leather Premium F	· Leather Natural F

Base

- 03 polished aluminium
- 30 basic dark powder-coated (smooth)

Suita, back cushions: pointed

Antonio Citterio, 2010/2019

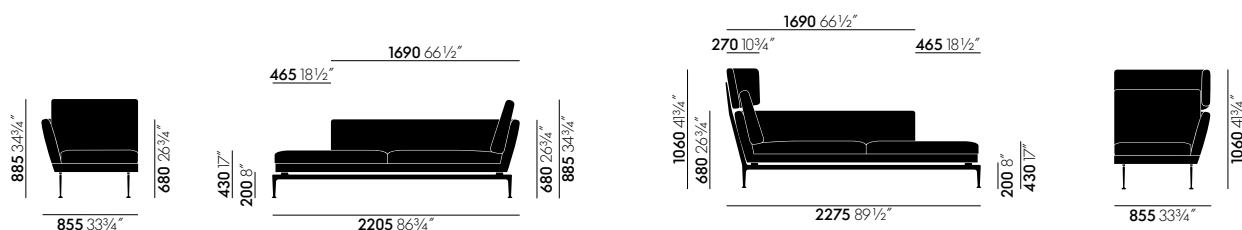

Suita Chaise Longue large, left

Suita Chaise Longue large, right, with head section

Suita Chaise Longue large, pointed cushions

	Article no.	without VAT in SEK*	with VAT in SEK*
	210 614 00		
Fabric F40		62.160,00	77.700,00
Fabric F60		65.200,00	81.500,00
Fabric F80		68.320,00	85.400,00
Fabric F100		71.440,00	89.300,00
Fabric F120		74.480,00	93.100,00
Leather L20		81.440,00	101.800,00
Leather L50		103.920,00	129.900,00
Leather L60		133.520,00	166.900,00

Surcharges header section

Fabric F40	7.200,00	9.000,00
Fabric F60	7.640,00	9.550,00
Fabric F80	8.000,00	10.000,00
Fabric F100	8.560,00	10.700,00
Fabric F120	8.960,00	11.200,00
Leather L20	9.840,00	12.300,00
Leather L50	13.120,00	16.400,00
Leather L60	17.840,00	22.300,00

Fabric F40	Fabric F60	Fabric F80	Fabric F100	Fabric F120	Leather L20	Leather L50	Leather L60
· Laser RE · Mello	· Olimpo · Volo	· Corsaro · Cosy 2 (cross stitch) · Dumet · Iroko 2 · Linho · Savana	· Nubia · Reed	· Credo	· Leather	· Leather Premium F	· Leather Natural F

Base

03 polished aluminium
30 basic dark powder-coated (smooth)

Suita, back cushions: pointed

Antonio Citterio, 2010/2019



Suita Ottoman

Suita Ottoman

	Article no.	without VAT in SEK*	with VAT in SEK*
	210 599 00		
Fabric F40		15.680,00	19.600,00
Fabric F60		16.400,00	20.500,00
Fabric F80		17.200,00	21.500,00
Fabric F100		18.160,00	22.700,00
Fabric F120		18.800,00	23.500,00
Leather L20		21.280,00	26.600,00
Leather L50		28.480,00	35.600,00
Leather L60		38.480,00	48.100,00

Fabric F40	Fabric F60	Fabric F80	Fabric F100	Fabric F120	Leather L20	Leather L50	Leather L60
· Laser RE · Mello	· Olimpo · Volo	· Corsaro · Cosy 2 (cross stitch) · Dumet · Iroko 2 · Linho · Savana	· Nubia · Reed	· Credo	· Leather	· Leather Premium F	· Leather Natural F

Base

03 polished aluminium
30 basic dark powder-coated (smooth)

Glides, Ottoman

04 glides for carpet
05 felt glides for hard floor

Suita cushions

Antonio Citterio, 2010/2019

vitra.



Pointed Cushion

	Article no.	without VAT in SEK*	with VAT in SEK*
40 x 40 cm	210 617 00		
Fabric F40		744,00	930,00
Fabric F60		904,00	1.130,00
Fabric F80		1.064,00	1.330,00
Fabric F100		1.224,00	1.530,00
Fabric F120		1.392,00	1.740,00
Leather L20		1.760,00	2.200,00
Leather L50		2.600,00	3.250,00
Leather L60		3.672,00	4.590,00

Pointed Cushion

	Article no.	without VAT in SEK*	with VAT in SEK*
40 x 60 cm	210 618 00		
Fabric F40		1.256,00	1.570,00
Fabric F60		1.472,00	1.840,00
Fabric F80		1.720,00	2.150,00
Fabric F100		1.992,00	2.490,00
Fabric F120		2.232,00	2.790,00
Leather L20		3.032,00	3.790,00
Leather L50		4.040,00	5.050,00
Leather L60		5.400,00	6.750,00

Pointed Cushion

	Article no.	without VAT in SEK*	with VAT in SEK*
60 x 60 cm	210 619 00		
Fabric F40		1.512,00	1.890,00
Fabric F60		1.760,00	2.200,00
Fabric F80		2.040,00	2.550,00
Fabric F100		2.232,00	2.790,00
Fabric F120		2.520,00	3.150,00
Leather L20		3.672,00	4.590,00
Leather L50		4.632,00	5.790,00
Leather L60		5.992,00	7.490,00

Pointed Cushion

	Article no.	without VAT in SEK*	with VAT in SEK*
80 x 60 cm	210 620 00		
Fabric F40		2.232,00	2.790,00
Fabric F60		2.632,00	3.290,00
Fabric F80		3.032,00	3.790,00
Fabric F100		3.512,00	4.390,00
Fabric F120		3.832,00	4.790,00
Leather L20		5.160,00	6.450,00
Leather L50		6.312,00	7.890,00
Leather L60		8.000,00	10.000,00

Suita cushions

Antonio Citterio, 2010/2019

vitra.



Suita Cushions

Pointed cushion sets	80 x 60 cm	60 x 60 cm	60 x 40 cm	40 x 40 cm	54 x 16 cm
2-Seater	1x	1x	1x	1x	
3-Seater	1x	2x	1x	1x	
Chaise Longue large	1x	1x	1x	1x	
Chaise Longue small		1x	1x		
Daybed					1x



Suita, tufted

Antonio Citterio, 2010/2019



Suita Sofa, tufted

with VAT in SEK*

F40 Laser RE Mello	F60 Olimpo Volo	F80 Corsaro Cosy 2 Dumet Iroko 2 Linho Savana	F100 Nubia Reed	F120 Credo
--------------------------	-----------------------	---	-----------------------	---------------

Suita Sofa 2-Seater 210 601 00

Upholstery soft	61.800,00	65.700,00	69.500,00	73.700,00	77.500,00
Surcharges					
+ Head Section	13.700,00	14.800,00	16.000,00	17.200,00	18.300,00
+ Tray	14.900,00	14.900,00	14.900,00	14.900,00	14.900,00

Suita Sofa 2-Seater open 210 602 00

Upholstery soft	60.400,00	64.000,00	67.300,00	70.800,00	74.300,00
Surcharges					
+ Tray	14.900,00	14.900,00	14.900,00	14.900,00	14.900,00

Suita Sofa 3-Seater 210 603 00

Upholstery soft	76.800,00	81.300,00	85.800,00	90.300,00	94.900,00
Surcharges					
+ Head Section	14.600,00	16.000,00	17.500,00	18.900,00	20.300,00
+ Tray	17.000,00	17.000,00	17.000,00	17.000,00	17.000,00

Suita Sofa 3-Seater open 210 604 00

Upholstery soft	74.900,00	79.300,00	83.700,00	88.000,00	92.200,00
Surcharges					
+ Tray	17.000,00	17.000,00	17.000,00	17.000,00	17.000,00

Suita Sofa Chaise Longue small 210 605 00

Upholstery soft	56.500,00	59.600,00	63.000,00	65.900,00	69.000,00
Surcharges					
+ Head Section	9.000,00	9.550,00	10.000,00	10.700,00	11.200,00

Suita Sofa Chaise Longue large 210 606 00

Upholstery soft	83.200,00	87.100,00	91.200,00	95.200,00	99.100,00
Surcharges					
+ Head Section	9.000,00	9.550,00	10.000,00	10.700,00	11.200,00

Suita Ottoman 210 607 00

Upholstery soft	25.100,00	26.200,00	27.300,00	28.100,00	29.500,00
-----------------	-----------	-----------	-----------	-----------	-----------

Suita Daybed, with roll cushion 210 608 00

Upholstery soft	42.500,00	44.300,00	46.500,00	48.300,00	50.300,00
-----------------	-----------	-----------	-----------	-----------	-----------

Suita Cushions

Cushion for head section	210 615 00	1.130,00	1.280,00	1.470,00	1.640,00	1.790,00
Armrest cushion 59 x 15 x 27 cm	210 600 00	2.550,00	3.190,00	3.890,00	4.650,00	5.290,00
Armrest cushion 59x15x27 cm (set of 2)	210 648 00	4.250,00	4.900,00	5.600,00	6.450,00	7.100,00
Roll cushions 54 x Ø16 cm	210 616 00	1.430,00	1.680,00	1.910,00	2.150,00	2.450,00

Suita, tufted

Antonio Citterio, 2010/2019

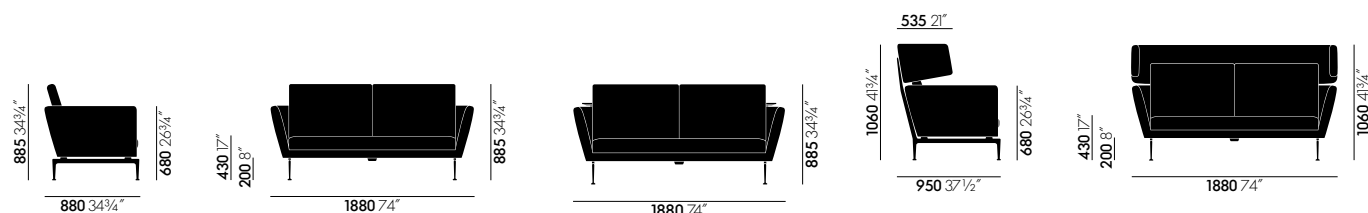

Suita Sofa 2-Seater

Suita Sofa 2-Seater
with tray

Suita Sofa 2-Seater with head section

Suita Sofa 2-Seater tufted

	Article no.	without VAT in SEK*	with VAT in SEK*
	210 601 00		
Fabric F40		49.440,00	61.800,00
Fabric F60		52.560,00	65.700,00
Fabric F80		55.600,00	69.500,00
Fabric F100		58.960,00	73.700,00
Fabric F120		62.000,00	77.500,00
Surcharges tray			
basic dark		11.920,00	14.900,00
Surcharges header section			
Fabric F40		10.960,00	13.700,00
Fabric F60		11.840,00	14.800,00
Fabric F80		12.800,00	16.000,00
Fabric F100		13.760,00	17.200,00
Fabric F120		14.640,00	18.300,00

Fabric F40	Fabric F60	Fabric F80	Fabric F100	Fabric F120
· Laser RE	· Olimpo	· Corsaro	· Nubia	· Credo
· Mello	· Valo	· Cosy 2 (cross stitch)	· Reed	
		· Dumer		
		· Iroko 2		
		· Linho		
		· Savana		

Base	Tray	Tray inlay
03 polished aluminium	30 basic dark powder-coated (smooth)	01 pebble
30 basic dark powder-coated (smooth)		02 charcoal

Suita, tufted

Antonio Citterio, 2010/2019

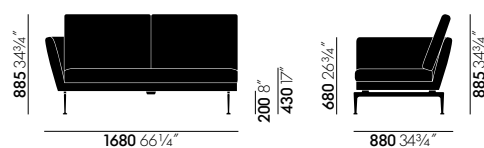

Suita Sofa 2-Seater, open, armrest left

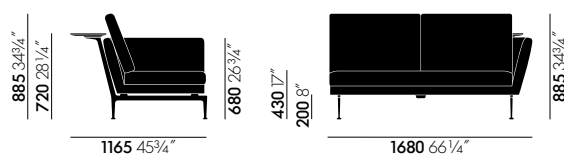

Suita Sofa 2-Seater, open, armrest right, with tray

Suita Sofa Two-Seater open, tufted

	Article no.	without VAT in SEK*	with VAT in SEK*
	210 602 00		
Fabric F40		48.320,00	60.400,00
Fabric F60		51.200,00	64.000,00
Fabric F80		53.840,00	67.300,00
Fabric F100		56.640,00	70.800,00
Fabric F120		59.440,00	74.300,00
Surcharges tray			
basic dark		11.920,00	14.900,00

Fabric F40	Fabric F60	Fabric F80	Fabric F100	Fabric F120
· Laser RE · Mello	· Olimpo · Valo	· Corsaro · Cosy 2 (cross stitch) · Dumet · Iroko 2 · Linho · Savana	· Nubia · Reed	· Credo

Base	Tray	Tray inlay
03 polished aluminium 30 basic dark powder-coated (smooth)	30 basic dark powder-coated (smooth)	01 pebble 02 charcoal

Suita, tufted

Antonio Citterio, 2010/2019

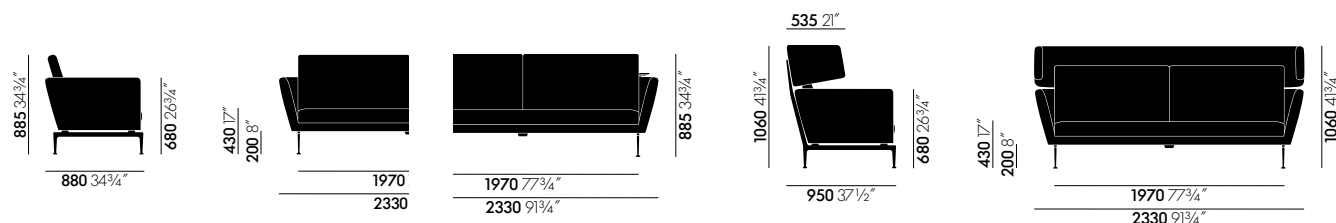

Suita Sofa 3-Seater

Suita Sofa 3-Seater with tray

Suita Sofa 3-Seater with head section

Suita Sofa 3-Seater tufted

	Article no.	without VAT in SEK*	with VAT in SEK*
	210 603 00		
Fabric F40		61.440,00	76.800,00
Fabric F60		65.040,00	81.300,00
Fabric F80		68.640,00	85.800,00
Fabric F100		72.240,00	90.300,00
Fabric F120		75.920,00	94.900,00
Surcharges tray			
basic dark		13.600,00	17.000,00
Surcharges header section			
Fabric F40		11.680,00	14.600,00
Fabric F60		12.800,00	16.000,00
Fabric F80		14.000,00	17.500,00
Fabric F100		15.120,00	18.900,00
Fabric F120		16.240,00	20.300,00

Fabric F40	Fabric F60	Fabric F80	Fabric F100	Fabric F120
. Laser RE	. Olimpo	. Corsaro	. Nubia	. Credo
. Mello	. Valo	. Cosy 2 (cross stitch)	. Reed	
		. Dumer		
		. Iroko 2		
		. Linho		
		. Savana		

Base	Tray	Tray inlay
03 polished aluminium	30 basic dark powder-coated (smooth)	01 pebble
30 basic dark powder-coated (smooth)		02 charcoal

Suita, tufted

Antonio Citterio, 2010/2019

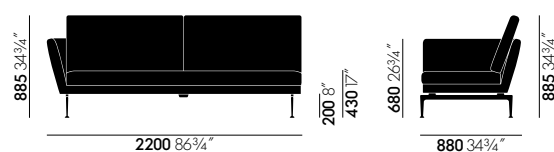

Suita Sofa 3-Seater, open, armrest left

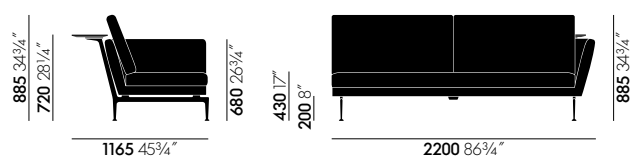

Suita Sofa 3-Seater, open, armrest right, with tray

Suita Sofa 3-Seater open, tufted

	Article no.	without VAT in SEK*	with VAT in SEK*
	210 604 00		
Fabric F40		59.920,00	74.900,00
Fabric F60		63.440,00	79.300,00
Fabric F80		66.960,00	83.700,00
Fabric F100		70.400,00	88.000,00
Fabric F120		73.760,00	92.200,00
Surcharges tray			
basic dark		13.600,00	17.000,00

Fabric F40	Fabric F60	Fabric F80	Fabric F100	Fabric F120
. Laser RE	. Olimpo	. Corsaro	. Nubia	. Credo
. Mello	. Valo	. Cosy 2 (cross stitch)	. Reed	
		. Dumet		
		. Iroko 2		
		. Linho		
		. Savana		

Base	Tray	Tray inlay
03 polished aluminium	30 basic dark powder-coated (smooth)	01 pebble
30 basic dark powder-coated (smooth)		02 charcoal

Suita, tufted

Antonio Citterio, 2010/2019



Suita Chaise Longue small, left

Suita Chaise Longue small, right, with head section

Suita Chaise Longue small, tufted

	Article no.	without VAT in SEK*	with VAT in SEK*
	210 605 00		
Fabric F40		45.200,00	56.500,00
Fabric F60		47.680,00	59.600,00
Fabric F80		50.400,00	63.000,00
Fabric F100		52.720,00	65.900,00
Fabric F120		55.200,00	69.000,00
Surcharges header section			
Fabric F40		7.200,00	9.000,00
Fabric F60		7.640,00	9.550,00
Fabric F80		8.000,00	10.000,00
Fabric F100		8.560,00	10.700,00
Fabric F120		8.960,00	11.200,00

Fabric F40	Fabric F60	Fabric F80	Fabric F100	Fabric F120
. Laser RE	. Olimpo	. Corsaro	. Nubia	. Credo
. Mello	. Volo	. Cosy 2 (cross stitch)	. Reed	
		. Dumet		
		. Iroko 2		
		. Linho		
		. Savana		

Base

- 03 polished aluminium
- 30 basic dark powder-coated (smooth)

Suita, tufted

Antonio Citterio, 2010/2019

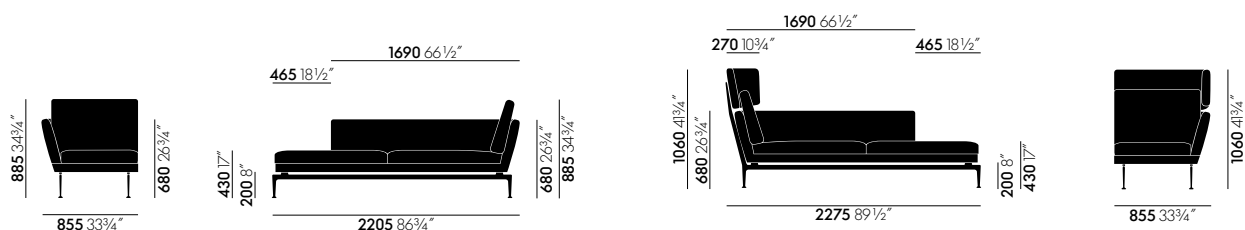

Suita Chaise Longue large, left

Suita Chaise Longue large, right, with head section

Suita Chaise Longue large, tufted

	Article no.	without VAT in SEK*	with VAT in SEK*
	210 606 00		
Fabric F40		66.560,00	83.200,00
Fabric F60		69.680,00	87.100,00
Fabric F80		72.960,00	91.200,00
Fabric F100		76.160,00	95.200,00
Fabric F120		79.280,00	99.100,00
Surcharges header section			
Fabric F40		7.200,00	9.000,00
Fabric F60		7.640,00	9.550,00
Fabric F80		8.000,00	10.000,00
Fabric F100		8.560,00	10.700,00
Fabric F120		8.960,00	11.200,00

Fabric F40	Fabric F60	Fabric F80	Fabric F100	Fabric F120
· Laser RE	· Olimpo	· Corsaro	· Nubia	· Credo
· Mello	· Valo	· Cosy 2 (cross stitch)	· Reed	
		· Dumet		
		· Irako 2		
		· Linho		
		· Savana		

Base

- 03 polished aluminium
- 30 basic dark powder-coated (smooth)

Suita Ottoman & Daybed

Antonio Citterio, 2010/2019

vitra.

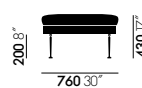
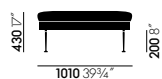

Suita Ottoman

Suita Daybed

Suita Ottoman tufted

	Article no.	without VAT in SEK*	with VAT in SEK*
	210 607 00		
Fabric F40		20.080,00	25.100,00
Fabric F60		20.960,00	26.200,00
Fabric F80		21.840,00	27.300,00
Fabric F100		22.480,00	28.100,00
Fabric F120		23.600,00	29.500,00

Suita Daybed tufted

	Article no.	without VAT in SEK*	with VAT in SEK*
Daybed with roll cushion	210 608 00		
Fabric F40		34.000,00	42.500,00
Fabric F60		35.440,00	44.300,00
Fabric F80		37.200,00	46.500,00
Fabric F100		38.640,00	48.300,00
Fabric F120		40.240,00	50.300,00

Fabric F40	Fabric F60	Fabric F80	Fabric F100	Fabric F120
· Laser RE	· Olimpo	· Corsaro	· Nubia	· Credo
· Mello	· Valo	· Cosy 2 (cross stitch)	· Reed	
		· Dumet		
		· Iroko 2		
		· Linho		
		· Savana		

Base	Glides, Ottoman
03 polished aluminium	04 glides for carpet
30 basic dark powder-coated (smooth)	05 felt glides for hard floor

Suita cushions

Antonio Citterio, 2010/2019

vitra.

Cushion for head section	Article no.	without VAT in SEK*	with VAT in SEK*
	210 615 00		
Fabric F40		904,00	1.130,00
Fabric F60		1.024,00	1.280,00
Fabric F80		1.176,00	1.470,00
Fabric F100		1.312,00	1.640,00
Fabric F120		1.432,00	1.790,00
Leather L20		1.880,00	2.350,00
Leather L50		2.680,00	3.350,00
Leather L60		3.800,00	4.750,00

Armrest cushion	Article no.	without VAT in SEK*	with VAT in SEK*
59 x 15 x 27 cm	210 600 00		
Fabric F40		2.040,00	2.550,00
Fabric F60		2.552,00	3.190,00
Fabric F80		3.112,00	3.890,00
Fabric F100		3.720,00	4.650,00
Fabric F120		4.232,00	5.290,00
Leather L20		4.312,00	5.390,00
Leather L50		6.552,00	8.190,00
Leather L60		9.600,00	12.000,00

Armrest cushion (set of 2)	Article no.	without VAT in SEK*	with VAT in SEK*
59 x 15 x 27 cm	210 648 00		
Fabric F40		3.400,00	4.250,00
Fabric F60		3.920,00	4.900,00
Fabric F80		4.480,00	5.600,00
Fabric F100		5.160,00	6.450,00
Fabric F120		5.680,00	7.100,00
Leather L20		8.720,00	10.900,00
Leather L50		12.960,00	16.200,00
Leather L60		19.120,00	23.900,00

Suita bolster cushion	Article no.	without VAT in SEK*	with VAT in SEK*
54 x ø 16 mm	210 616 00		
Fabric F40		1.144,00	1.430,00
Fabric F60		1.344,00	1.680,00
Fabric F80		1.528,00	1.910,00
Fabric F100		1.720,00	2.150,00
Fabric F120		1.960,00	2.450,00
Leather L20		2.200,00	2.750,00
Leather L50		3.080,00	3.850,00
Leather L60		4.312,00	5.390,00

Suita cushions

Antonio Citterio, 2010/2019

vitra.



Pointed Cushion

	Article no.	without VAT in SEK*	with VAT in SEK*
40 x 40 cm	210 617 00		
Fabric F40		744,00	930,00
Fabric F60		904,00	1.130,00
Fabric F80		1.064,00	1.330,00
Fabric F100		1.224,00	1.530,00
Fabric F120		1.392,00	1.740,00
Leather L20		1.760,00	2.200,00
Leather L50		2.600,00	3.250,00
Leather L60		3.672,00	4.590,00

Pointed Cushion

	Article no.	without VAT in SEK*	with VAT in SEK*
40 x 60 cm	210 618 00		
Fabric F40		1.256,00	1.570,00
Fabric F60		1.472,00	1.840,00
Fabric F80		1.720,00	2.150,00
Fabric F100		1.992,00	2.490,00
Fabric F120		2.232,00	2.790,00
Leather L20		3.032,00	3.790,00
Leather L50		4.040,00	5.050,00
Leather L60		5.400,00	6.750,00

Pointed Cushion

	Article no.	without VAT in SEK*	with VAT in SEK*
60 x 60 cm	210 619 00		
Fabric F40		1.512,00	1.890,00
Fabric F60		1.760,00	2.200,00
Fabric F80		2.040,00	2.550,00
Fabric F100		2.232,00	2.790,00
Fabric F120		2.520,00	3.150,00
Leather L20		3.672,00	4.590,00
Leather L50		4.632,00	5.790,00
Leather L60		5.992,00	7.490,00

Pointed Cushion

	Article no.	without VAT in SEK*	with VAT in SEK*
80 x 60 cm	210 620 00		
Fabric F40		2.232,00	2.790,00
Fabric F60		2.632,00	3.290,00
Fabric F80		3.032,00	3.790,00
Fabric F100		3.512,00	4.390,00
Fabric F120		3.832,00	4.790,00
Leather L20		5.160,00	6.450,00
Leather L50		6.312,00	7.890,00
Leather L60		8.000,00	10.000,00

Suita cushions

Antonio Citterio, 2010/2019

vitra.



Suita Cushions

Pointed cushion sets	80 x 60 cm	60 x 60 cm	60 x 40 cm	40 x 40 cm	54 x 16 cm
2-Seater	1x	1x	1x	1x	
3-Seater	1x	2x	1x	1x	
Chaise Longue large	1x	1x	1x	1x	
Chaise Longue small		1x	1x		
Daybed					1x

Suita Club Sofa

Antonio Citterio, 2010

vitra.

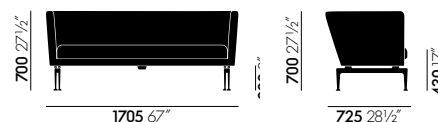

Suita Club Sofa and Armchair:

Body: moulded polyurethane foam with webbed metal frame.

Seat cushion: polyurethane foam and polyester fibre.

Seat height: 430 mm (355 mm with applied load, measured in accordance with EN 1335-1:2000).

Legs: die-cast aluminium, polished or powder-coated.

Glides for Suita Club Sofa: non-slip glides.

Glides for Suita Club Armchair: glides for carpet or felt glides for hard floors.

Suita Club Sofa

	Article no.	without VAT in SEK*	with VAT in SEK*
	210 338 00		
Fabric F40		37.120,00	46.400,00
Fabric F60		39.840,00	49.800,00
Fabric F120		48.480,00	60.600,00
Leather L20		54.160,00	67.700,00
Leather L50		66.640,00	83.300,00

Fabric F40	Fabric F60	Fabric F120	Leather L20	Leather L50	Base
. Laser RE	. Volo	. Credo	. Leather	. Leather Premium F	03 polished aluminium 30 basic dark powder-coated (smooth)

Suita Club Armchair

Antonio Citterio, 2010

vitra.

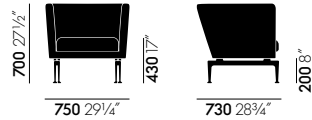

Suita Club Armchair

	Article no.	without VAT in SEK*	with VAT in SEK*
	210 333 00		
Fabric F40		21.680,00	27.100,00
Fabric F60		23.360,00	29.200,00
Fabric F80		23.920,00	29.900,00
Fabric F100		25.040,00	31.300,00
Fabric F120		26.720,00	33.400,00
Leather L20		29.520,00	36.900,00
Leather L50		38.240,00	47.800,00
Leather L60		50.720,00	63.400,00

Fabric F40	Fabric F60	Fabric F80	Fabric F100	Fabric F120	Leather L20	Leather L50	Leather L60
· Laser RE · Mello	· Olimpo · Velo	· Corsaro · Cosy 2 (cross stitch) · Dumet · Iroko 2 · Linho · Savana	· Nubia · Reed	· Credo	· Leather	· Leather Premium F	· Leather Natural F

Base	Glides
03 polished aluminium 30 basic dark powder-coated (smooth)	04 glides for carpet 05 felt glides for hard floor

Vlinder Sofa

Hella Jongerius, 2018

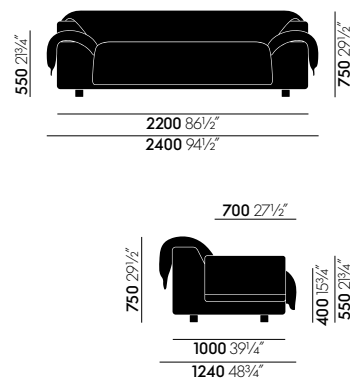

All measurements are pursuant to EN 1335-1:2000
More detailed information is found in the chapter 'Explanation of measurements'.

Body frame: wooden construction, with zigzag springs in the seat section and upholstery webbing in the backrest.

Upholstery construction (body): multilayer polyurethane foam in different levels of firmness, top layer made of viscoelastic foam, with polyester fleece.

Cover: chamber cushion structure, filled with a mix of goose feathers and down, as well as polyurethane and latex rods. Three-part design (two armrest sections, one seat-backrest section). Secured to sofa body with zip fasteners.

Seat height with cover: 400 mm (270 mm with applied load, measured in accordance with EN 1335-1:2000).

Covers: all covers are removable.

Glides: steel legs with felt glides

Note: designed only for private use. We recommend that the cover is regularly shaken.

Vlinder Sofa	Article no.	without VAT in SEK*	with VAT in SEK*
dark reds	210 588 01	95.760,00	119.700,00
dark greens	210 588 02	95.760,00	119.700,00
light reds	210 588 03	95.760,00	119.700,00
light greens	210 588 04	95.760,00	119.700,00

Coffee and side tables



Abalon Table
R & E Bouroullec
360



Coffee Table
Isamu Noguchi
361



Eames Coffee Table
Charles & Ray Eames
362



Elliptical Table ETR
Charles & Ray Eames
363



Flower Table
Alexander Girard
364



Guéridon Bas
Jean Prouvé
365



Metal Side Table
R & E Bouroullec
366



Wooden Side Table
R & E Bouroullec
369



NesTable
Jasper Morrison
370



Occasional Low Table
Jasper Morrison
371



Occasional Table LTR
Charles & Ray Eames
372



Plate Table
Jasper Morrison
373

Office and conference chairs (swivel)

Chairs

Tables

Desks

Public waiting areas

Lounge chairs and armchairs

Sofas

Coffee and side tables

Stools and benches

Storage and partition elements

Accessories

Living, dining, decorative objects, home office,
clocks, lighting, publications

Quick Ship programme

General terms, conditions
and information

Abalon Table

Ronan & Erwan Bouroullec, 2022

vitra.

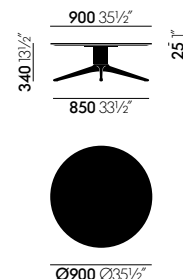

All measurements are pursuant to EN 1335-1:2000
More detailed information is found in the chapter 'Explanation of measurements'.

Table top: base material MDF (medium-density fibreboard) in real oak veneer or textured powder-coated finish; table thickness 25 mm with 15° bevelled edge.

Base: non-swivel four-star base in die-cast aluminium, powder-coated finish, pedestal in steel, powder-coated finish.

Glides: plastic glides for soft floors or felt glides for hard floors.

Abalon Table	Article no.	without VAT in SEK*	with VAT in SEK*
	210 743 00		
MDF powder-coated in soft light	B1S52	10.720,00	13.400,00
MDF powder-coated in basic dark	B1S30	10.720,00	13.400,00
light oak	C1S17	17.200,00	21.500,00
dark oak	C1S04	17.200,00	21.500,00

Base

12 deep black powder-coated (smooth)
91 mint powder-coated (smooth)

Glides (Platform and Table)

04 glides for carpet
05 felt glides for hard floor

Coffee Table

Isamu Noguchi, 1944

vitra.

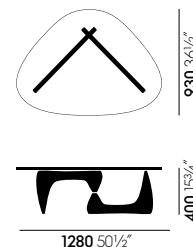

Table top: heavy glass, 19 mm, ground rounded edges.

Base: solid ash in black, walnut or maple, lacquered finish, rounded edges.

Origin of wood: ash (*Fraxinus excelsior*), walnut (*Juglans nigra*) and maple (*Acer platanoides*) from Western Europe and/or Poland.

Coffee Table	Article no.	without VAT in SEK*	with VAT in SEK*
black ash	201 300 01	23.200,00	29.000,00
walnut	201 300 02	32.880,00	41.100,00
maple	201 300 03	23.200,00	29.000,00

Eames Coffee Table

Charles & Ray Eames, 1953

vitra.

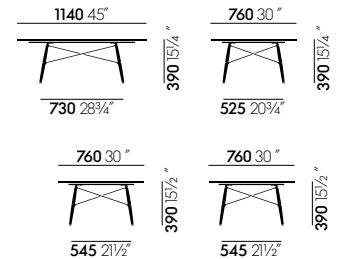

Table top: solid American walnut with oiled finish or Carrara marble, brushed and waxed.

Base platform: MDF board.

Base: solid ash, honey-coloured or black finish; steel rod cross struts, powder-coated in basic dark.

Origin of wood: ash (*Fraxinus excelsior*) from Western Europe and/or Poland; American walnut (*Juglans nigra*) from the USA.

Eames Coffee Table, 1140 x 760

	Article no.	without VAT in SEK*	with VAT in SEK*
white marble, base in black ash	210 521 21	22.480,00	28.100,00
white marble, base in honey-toned ash	210 521 22	22.480,00	28.100,00
solid American walnut, oiled finish, base in black ash	210 521 31	27.920,00	34.900,00
solid American walnut, oiled finish, base in honey-toned ash	210 521 32	27.920,00	34.900,00
Base black ash	for stone table tops	210 521 91	8.160,00
Base ash honey tone	for stone table tops	210 521 92	8.160,00

Eames Coffee Table square, 760 x 760

	Article no.	without VAT in SEK*	with VAT in SEK*
white marble, base in black ash	210 520 21	20.160,00	25.200,00
white marble, base in honey-toned ash	210 520 22	20.160,00	25.200,00
solid American walnut, oiled finish, base in black ash	210 520 31	22.560,00	28.200,00
solid American walnut, oiled finish, base in honey-toned ash	210 520 32	22.560,00	28.200,00
Base black ash	for stone table tops	210 520 91	6.952,00
Base ash honey tone	for stone table tops	210 520 92	6.952,00

Elliptical Table ETR

Charles & Ray Eames, 1951

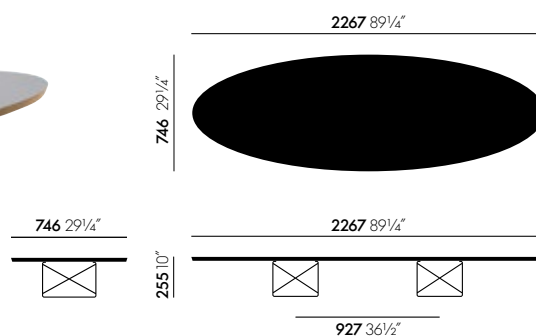

Table top: plywood core, high-pressure laminate surface.

Base: steel wire, chrome-plated or powder-coated.

Range of use: recommended for residential use only.

Elliptical Table ETR

	Article no.	without VAT in SEK*	with VAT in SEK*
HPL black, base chromed	412 106 00	19.880,00	24.850,00
HPL white, base chromed	412 107 00	19.880,00	24.850,00
HPL black, base powder-coated in basic dark	412 106 01	19.880,00	24.850,00
HPL white, base powder-coated in basic dark	412 107 01	19.880,00	24.850,00

Flower Table

Alexander Girard, 1977

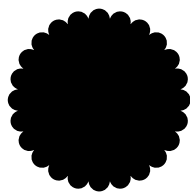

Ø800 31½"

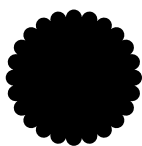

Ø600 23½"

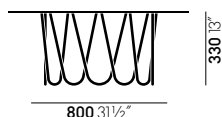

330 13"

800 31½"

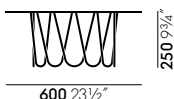

250 9¾"

600 23½"

Flower Table, large

Flower Table, small

- **Table top and base:** powder-coated steel. Suited for outdoor use.



Flower Table

Large, anthracite

201 390 06

SEK* 7.880,00 / **9.850,00**



Flower Table

Small, anthracite

201 390 05

SEK* 6.040,00 / **7.550,00**



Flower Table

large, red

201 390 02

SEK* 7.880,00 / **9.850,00**



Flower Table

Small, red

201 390 01

SEK* 6.040,00 / **7.550,00**

Guéridon Bas

Jean Prouvé, 1944

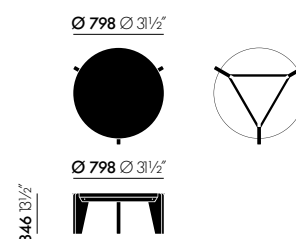

Table top: solid wood in natural oak with oiled finish, dark stained oak with protective natural lacquer finish, or American walnut with oiled finish.

Base: legs matched to table top, solid wood in natural oak with oiled finish, dark stained oak with protective natural lacquer finish, or American walnut with oiled finish; connecting element: bent sheet metal, powder-coated (smooth) in deep black.

Origin of wood: oak (*Quercus robur*) from Western Europe and/or Poland; American walnut (*Juglans nigra*) from the USA.

Guéridon Bas

	Article no.	without VAT in SEK*	with VAT in SEK*
	212 043 00		
solid natural oak, oiled	70	21.000,00	26.250,00
solid dark oak, with protective varnish	04	24.200,00	30.250,00
solid American walnut, oiled	75	27.080,00	33.850,00

Metal Side Tables

Ronan & Erwan Bouroullec, 2004

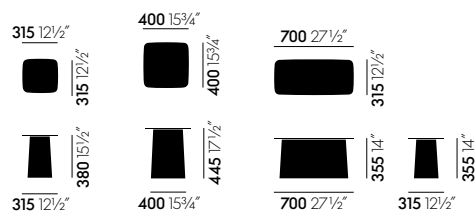

Table top and base: bent and welded sheet steel, powder-coated with highly polished finish.

Glides: felt glides.



Metal Side Table

white

210 167 01

SEK* 5.240,00 / **6.550,00**



Metal Side Table

white

210 166 01

SEK* 6.120,00 / **7.650,00**



Metal Side Table

white

210 165 01

SEK* 7.000,00 / **8.750,00**



Metal Side Table

chocolate

210 167 04

SEK* 5.240,00 / **6.550,00**



Metal Side Table

chocolate

210 166 04

SEK* 6.120,00 / **7.650,00**



Metal Side Table

chocolate

210 165 04

SEK* 7.000,00 / **8.750,00**

Metal Side Tables

Ronan & Erwan Bouroullec, 2004

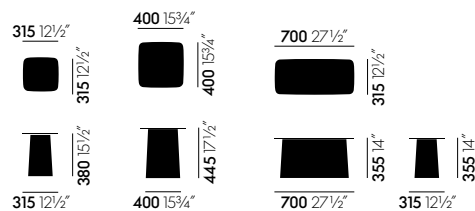

Table top and base: bent and welded sheet steel, galvanised, optional powder-coating with fine surface texture. The galvanised version is finished with an irregular surface polish.

Glides: polyamide.

Applications: galvanised Metal Side Tables, optionally powder-coated with a fine surface texture, are suitable for indoor and outdoor use. If used frequently outdoors, the galvanised version without powder coating can acquire a typical patina over time.



Metal Side Table (Outdoor)

soft light

210 506 52

SEK* 5.752,00 / **7.190,00**



Metal Side Table (Outdoor)

soft light

210 507 52

SEK* 6.600,00 / **8.250,00**



Metal Side Table (Outdoor)

soft light

210 508 52

SEK* 7.672,00 / **9.590,00**



Metal Side Table (Outdoor)

ice grey

210 506 23

SEK* 5.752,00 / **7.190,00**



Metal Side Table (Outdoor)

ice grey

210 507 23

SEK* 6.600,00 / **8.250,00**



Metal Side Table (Outdoor)

ice grey

210 508 23

SEK* 7.672,00 / **9.590,00**



Metal Side Table (Outdoor)

dim grey

210 506 21

SEK* 5.752,00 / **7.190,00**



Metal Side Table (Outdoor)

dim grey

210 507 21

SEK* 6.600,00 / **8.250,00**



Metal Side Table (Outdoor)

dim grey

210 508 21

SEK* 7.672,00 / **9.590,00**

Metal Side Tables

Ronan & Erwan Bouroullec, 2004



Metal Side Table (Outdoor)

black

210 506 12

SEK* 5.752,00 / **7.190,00**



Metal Side Table (Outdoor)

black

210 507 12

SEK* 6.600,00 / **8.250,00**



Metal Side Table (Outdoor)

black

210 508 12

SEK* 7.672,00 / **9.590,00**



Metal Side Table (Outdoor)

galvanised

215 121 01

SEK* 5.240,00 / **6.550,00**



Metal Side Table (Outdoor)

galvanised

215 122 01

SEK* 6.120,00 / **7.650,00**



Metal Side Table (Outdoor)

galvanised

215 123 01

SEK* 7.000,00 / **8.750,00**

Wooden Side Tables

Ronan & Erwan Bouroullec, 2015

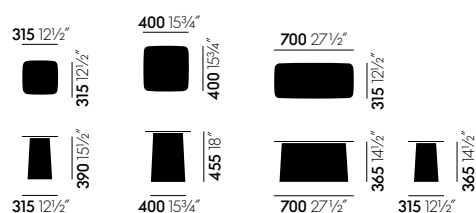

Table top and base: moulded plywood.

Glides: felt glides.



Wooden Side Table small

light oak

210 512 11

SEK* 7.960,00 / **9.950,00**



Wooden Side Table medium

light oak

210 513 11

SEK* 9.080,00 / **11.350,00**



Wooden Side Table large

light oak

210 514 11

SEK* 10.920,00 / **13.650,00**



Wooden Side Table small

dark oak

210 512 12

SEK* 7.960,00 / **9.950,00**



Wooden Side Table medium

dark oak

210 513 12

SEK* 9.080,00 / **11.350,00**



Wooden Side Table large

dark oak

210 514 12

SEK* 10.920,00 / **13.650,00**



Wooden Side Table small

walnut

210 512 13

SEK* 8.600,00 / **10.750,00**



Wooden Side Table medium

walnut

210 513 13

SEK* 9.560,00 / **11.950,00**



Wooden Side Table large

walnut

210 514 13

SEK* 11.400,00 / **14.250,00**

NesTable

Jasper Morrison, 2007



Tray: polyurethane.

Column: steel, powder-coated textured finish.

Extension bar: steel, polished chrome finish.

Base: die-cast aluminium, powder-coated textured finish.



NesTable

basic dark

H 574 x W 500 x D 350 mm

860 130 14

SEK* 6.760,00 / **8.450,00**



NesTable

soft mint

H 574 x W 500 x D 350 mm

860 130 18

SEK* 6.760,00 / **8.450,00**



NesTable

sea blue

H 574 x W 500 x D 350 mm

860 130 21

SEK* 6.760,00 / **8.450,00**



NesTable

bright red

H 574 x W 500 x D 350 mm

860 130 20

SEK* 6.760,00 / **8.450,00**



NesTable

soft light

H 574 x W 500 x D 350 mm

860 130 15

SEK* 6.760,00 / **8.450,00**



NesTable

ice grey

H 574 x W 500 x D 350 mm

860 130 19

SEK* 6.760,00 / **8.450,00**



NesTable

warm grey

H 574 x W 500 x D 350 mm

860 130 17

SEK* 6.760,00 / **8.450,00**

Occasional Low Table

Jasper Morrison, 2016

vitra.

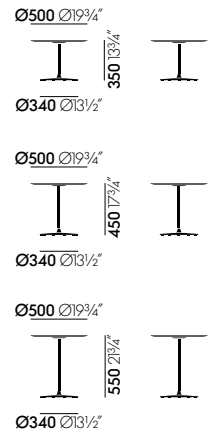

Table top: solid wood in natural oak with oiled finish, dark stained oak with protective natural lacquer finish, or American walnut with oiled finish; or die-cast aluminium with powder-coated textured finish.

Column: steel, powder-coated textured finish.

Base: die-cast zinc, powder-coated textured finish.

Origin of wood: oak (*Quercus robur*) from Western Europe and/or Poland; American walnut (*Juglans nigra*) from the USA.

Occasional Low Table 35	Article no.	without VAT in SEK*	with VAT in SEK*
aluminium, powder-coated in chocolate, base in chocolate	210 515 11	5.800,00	7.250,00
solid natural oak, oiled finish, base in chocolate	210 515 21	6.792,00	8.490,00
Dark stained oak with protective natural lacquer finish, base in colour chocolate	210 515 24	6.792,00	8.490,00
solid American walnut, oiled finish, base in chocolate	210 515 23	8.600,00	10.750,00

Occasional Low Table 45	Article no.	without VAT in SEK*	with VAT in SEK*
aluminium, powder-coated in chocolate, base in chocolate	210 516 11	5.880,00	7.350,00
solid natural oak, oiled finish, base in chocolate	210 516 21	6.872,00	8.590,00
Dark stained oak with protective natural lacquer finish, base in colour chocolate	210 516 24	6.872,00	8.590,00
solid American walnut, oiled finish, base in chocolate	210 516 23	8.600,00	10.750,00

Occasional Low Table 55	Article no.	without VAT in SEK*	with VAT in SEK*
aluminium, powder-coated in chocolate, base in chocolate	210 517 11	5.960,00	7.450,00
solid natural oak, oiled finish, base in chocolate	210 517 21	6.952,00	8.690,00
Dark stained oak with protective natural lacquer finish, base in colour chocolate	210 517 24	6.952,00	8.690,00
solid American walnut, oiled finish, base in chocolate	210 517 23	8.760,00	10.950,00

Occasional Table LTR

Charles & Ray Eames, 1950

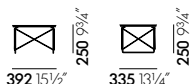

Wooden table top: solid wood in natural oak with oiled finish, dark stained oak with protective natural lacquer finish, or American walnut with oiled finish.

Origin of wood: oak (*Quercus robur*) from Western Europe and/or Poland; American walnut (*Juglans nigra*) from the USA.

HPL table top: plywood core, high-pressure laminate surface.

Gold leaf table top: plywood core, gilded surface with transparent coating.

Marble table top: Carrara marble (Italy).

Base: steel wire, chrome-plated or powder-coated.



Occasional Table LTR

HPL white,
base chromed

201 195 03

SEK* 2.760,00 / **3.450,00**



Occasional Table LTR

HPL black,
base chromed

201 195 04

SEK* 2.760,00 / **3.450,00**



Occasional Table LTR

gold leaf,
base chromed

201 195 09

SEK* 5.960,00 / **7.450,00**



Occasional Table LTR

solid American walnut,
base chromed

201 195 13

SEK* 4.312,00 / **5.390,00**



Occasional Table LTR

HPL white,
base basic dark

201 195 33

SEK* 2.760,00 / **3.450,00**



Occasional Table LTR

HPL black,
base basic dark

201 195 30

SEK* 2.760,00 / **3.450,00**



Occasional Table LTR

gold leaf,
base basic dark

201 195 39

SEK* 5.960,00 / **7.450,00**



Occasional Table LTR

solid American walnut,
base basic dark

201 195 16

SEK* 4.312,00 / **5.390,00**



Occasional Table LTR

natural solid oak,
base chromed

201 195 11

SEK* 3.432,00 / **4.290,00**



Occasional Table LTR

dark solid oak,
base chromed

201 195 20

SEK* 3.640,00 / **4.550,00**



Occasional Table LTR

Light-coloured marble,
chrome-plated base

201 195 18

SEK* 6.440,00 / **8.050,00**



Occasional Table LTR

natural solid oak,
base basic dark

201 195 14

SEK* 3.432,00 / **4.290,00**



Occasional Table LTR

dark solid oak,
base basic dark

201 195 21

SEK* 3.640,00 / **4.550,00**



Occasional Table LTR

Light-coloured marble,
base in basic dark

201 195 19

SEK* 6.440,00 / **8.050,00**

Plate Table

Jasper Morrison, 2004



Table top: solid natural oak with oiled finish or dark stained oak with protective natural lacquer finish; powder-coated MDF; or Carrara marble, brushed and waxed; table thickness 15 mm.

Base: die-cast aluminium and powder-coated tubular steel.

Origin of wood: oak (*Quercus robur*) from Western Europe and/or Poland.

Plate Table 410 x 410

	Article no.	without VAT in SEK*	with VAT in SEK*
Carrara marble, base powder-coated in white (textured finish)	210 540 11	13.760,00	17.200,00
MDF white, base powder-coated in white (textured finish)	210 540 31	9.120,00	11.400,00
MDF in basic dark, base powder-coated in basic dark (textured)	210 540 33	9.120,00	11.400,00
Solid natural oak, oiled finish, base powder- coated in basic dark (textured)	210 540 24	10.080,00	12.600,00
Dark oak, protective natural lacquer finish, base powder-coated in basic dark (textured)	210 540 25	12.080,00	15.100,00

Plate Table 410 x 710

	Article no.	without VAT in SEK*	with VAT in SEK*
Carrara marble, base powder-coated in white (textured finish)	210 542 11	14.640,00	18.300,00
MDF white, base powder-coated in white (textured finish)	210 542 31	10.080,00	12.600,00
MDF in basic dark, base powder-coated in basic dark (textured)	210 542 33	10.080,00	12.600,00
Solid natural oak, oiled finish, base powder- coated in basic dark (textured)	210 542 24	12.080,00	15.100,00
Dark oak, protective natural lacquer finish, base powder-coated in basic dark (textured)	210 542 25	13.120,00	16.400,00

Plate Table

Jasper Morrison, 2004

vitra.

Plate Table 410 x 1130

	Article no.	without VAT in SEK*	with VAT in SEK*
Carrara marble, base powder-coated in white (textured finish)	210 543 11	18.880,00	23.600,00
MDF white, base powder-coated in white (textured finish)	210 543 31	12.080,00	15.100,00
MDF in basic dark, base powder-coated in basic dark (textured)	210 543 33	12.080,00	15.100,00
Solid natural oak, oiled finish, base powder- coated in basic dark (textured)	210 543 24	14.640,00	18.300,00
Dark oak, protective natural lacquer finish, base powder-coated in basic dark (textured)	210 543 25	16.240,00	20.300,00

Plate Table 710 x 710

	Article no.	without VAT in SEK*	with VAT in SEK*
Carrara marble, base powder-coated in white (textured finish)	210 541 11	18.880,00	23.600,00
MDF white, base powder-coated in white (textured finish)	210 541 31	12.400,00	15.500,00
MDF in basic dark, base powder-coated in basic dark (textured)	210 541 33	12.400,00	15.500,00
Solid natural oak, oiled finish, base powder- coated in basic dark (textured)	210 541 24	14.160,00	17.700,00
Dark oak, protective natural lacquer finish, base powder-coated in basic dark (textured)	210 541 25	16.320,00	20.400,00

Plate Table 710 x 1130

	Article no.	without VAT in SEK*	with VAT in SEK*
Carrara marble, base powder-coated in white (textured finish)	210 544 11	27.040,00	33.800,00
MDF white, base powder-coated in white (textured finish)	210 544 31	16.640,00	20.800,00
MDF in basic dark, base powder-coated in basic dark (textured)	210 544 33	16.640,00	20.800,00
Solid natural oak, oiled finish, base powder- coated in basic dark (textured)	210 544 24	19.680,00	24.600,00
Dark oak, protective natural lacquer finish, base powder-coated in basic dark (textured)	210 544 25	23.280,00	29.100,00



Stools and benches



Bovist
Hella Jongerius
378



Butterfly Stool
Sori Yanagi
379



Chap
Konstantin Grcic
380



Cork Family
Jasper Morrison
381



Elephant Stool
Sori Yanagi
382



Nelson Bench
George Nelson
383



Stools
Charles & Ray Eames
384



Tabouret 307
Jean Prouvé
385



Tabouret Bois
Jean Prouvé
386



Tabouret Métallique
Jean Prouvé
387



Visiona Stool
Verner Panton
388



Wiggle Stool
Frank Gehry
389

Other products in this chapter



Wiggle Side Chair
Frank Gehry
389

Office and conference chairs (swivel)

Chairs

Tables

Desks

Public waiting areas

Lounge chairs and armchairs

Sofas

Coffee and side tables

Stools and benches

Storage and partition elements

Accessories

Living, dining, decorative objects, home office,
clocks, lighting, publications

Quick Ship programme

General terms, conditions
and information



Bovist

Hella Jongerius, 2019



380 15

Ø540 Ø21¼"

All measurements are pursuant to EN 1335-1:2000
 More detailed information is found in the chapter 'Explanation of measurements'.

Filling: synthetic beads.

Upholstery cover: Tailored Fabric (87% new wool, 7% cotton, 6% polyamide).

Bottom cover: Pure (UK: Volo).

**Bovist**

dark reds

210 589 01SEK* 7.032,00 / **8.790,00****Bovist**

dark greens

210 589 02SEK* 7.032,00 / **8.790,00****Bovist**

light greens

210 589 04SEK* 7.032,00 / **8.790,00****Bovist**

light reds

210 589 03SEK* 7.032,00 / **8.790,00**

Butterfly Stool

Sori Yanagi, 1954



Material: moulded maple plywood with natural finish (Germany/France) or santos palisander (Bolivia), brass fittings.



Butterfly Stool

moulded plywood

maple

201 370 01

SEK* 6.872,00 / **8.590,00**



Butterfly Stool

moulded plywood

palisander

201 370 02

SEK* 8.600,00 / **10.750,00**

Chap

Konstantin Grcic, 2021

vitra.



Material: recycled polypropylene, 100% recyclable.



Chap
deep black RE
201 393 01
SEK* 840,00 / 1.050,00



Chap
brick RE
201 393 04
SEK* 840,00 / 1.050,00



Chap
dark grey RE
201 393 02
SEK* 840,00 / 1.050,00



Chap
sea blue RE
201 393 03
SEK* 840,00 / 1.050,00



Chap Tray
deep black RE
201 398 01
SEK* 280,00 / 350,00



Chap Tray
brick RE
201 398 04
SEK* 280,00 / 350,00



Chap Tray
dark grey RE
201 398 02
SEK* 280,00 / 350,00



Chap Tray
sea blue RE
201 398 03
SEK* 280,00 / 350,00

Cork Family

Jasper Morrison, 2004

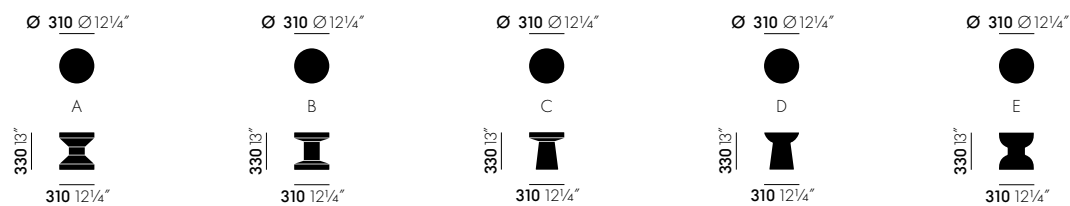

Material: pure cork, lathe-turned, untreated surface.



Cork Family

Model A

210 012 01

SEK* 4.152,00 / **5.190,00**



Cork Family

Model B

210 023 01

SEK* 4.152,00 / **5.190,00**



Cork Family

Model C

210 024 01

SEK* 4.152,00 / **5.190,00**



Cork Family

Model D

210 646 01

SEK* 4.152,00 / **5.190,00**



Cork Family

Model E

210 647 01

SEK* 4.152,00 / **5.190,00**

Elephant Stool

Sori Yanagi, 1954



Material: dyed-through polypropylene.

Applications: suitable for outdoor use. Special additives help to prevent colours from fading due to UV radiation. However, if the stool is exposed to sunlight for prolonged periods, the colour may change over time. We recommend limited exposure to sunlight.



Elephant Stool

black

210 020 02

SEK* 952,00 / **1.190,00**



Elephant Stool

cream

210 020 30

SEK* 952,00 / **1.190,00**

Nelson Bench

George Nelson, 1946



Seat: slatted wood in solid ash, lacquered.

Base: ash, lacquered in black.

Applications: not recommended for public spaces.

Origin of wood: ash (*Fraxinus excelsior*) from Western Europe and/or Poland.



Nelson Bench

H 353 x W 1220 x D 469 mm

black ash

210 231 02

SEK* 7.880,00 / **9.850,00**



Nelson Bench

H 353 x W 1837 x D 469 mm

black ash

405 502 02

SEK* 11.560,00 / **14.450,00**



Nelson Bench

H 353 x W 1220 x D 469 mm

natural ash

210 231 01

SEK* 7.880,00 / **9.850,00**



Nelson Bench

H 353 x W 1837 x D 469 mm

natural ash

405 502 00

SEK* 11.560,00 / **14.450,00**

Stools

Charles & Ray Eames, 1960

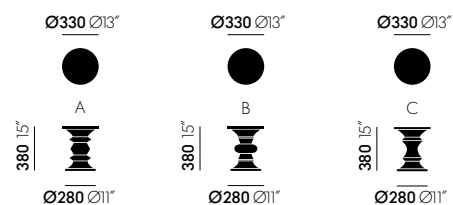

Model A

Model B

Model C

Material: laminated sections of solid walnut, lathe-turned, transparent lacquer finish.

Origin of wood: walnut (*Juglans nigra*) from Western Europe and/or Poland.

Stools		Article no.	without VAT in SEK*	with VAT in SEK*
Model A	solid walnut	412 355 01	14.280,00	17.850,00
Model B	solid walnut	412 356 01	14.280,00	17.850,00
Model C	solid walnut	412 357 01	14.280,00	17.850,00

Tabouret N° 307

Jean Prouvé, 1951

vitra.

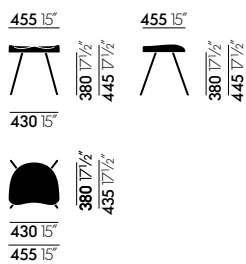

Base: steel, powder-coated finish.

Seat: solid natural oak with oiled finish or solid dark stained oak with clear protective lacquer finish. Plastic glides.



Tabouret 307

Natural solid oak

212 059 70

SEK* 7.112,00 / **8.890,00**



Tabouret 307

Dark solid oak

212 059 04

SEK* 7.112,00 / **8.890,00**

Tabouret Bois

Jean Prouvé, 1941

vitra.



Seat and base: solid wood in natural oak with oiled finish, dark stained oak with protective natural lacquer finish, or American walnut with oiled finish; connecting element: sheet metal, powder-coated (smooth) in deep black.

Origin of wood: oak (*Quercus robur*) from Western Europe and/or Poland; American walnut (*Juglans nigra*) from the USA.

Tabouret Bois

	Article no.	without VAT in SEK*	with VAT in SEK*
	212 026 00		
natural solid oak, oiled	70	6.520,00	8.150,00
dark solid oak, with protective varnish	04	6.520,00	8.150,00
solid American walnut, oiled	75	7.912,00	9.890,00

Tabouret Métallique

Jean Prouvé, 1936

380 15"



285 11 1/4"



Ø 380 15"

Material: bent sheet steel, powder-coated finish. Plastic glides.



Tabouret Métallique

Prouvé Blanc Colombe (Ecrû)

212 058 88

SEK* 6.232,00 / **7.790,00**



Tabouret Métallique

Japanese red

212 058 06

SEK* 6.232,00 / **7.790,00**



Tabouret Métallique

Prouvé Bleu Marcoule

212 058 41

SEK* 6.232,00 / **7.790,00**



Tabouret Métallique

deep black

212 058 12

SEK* 6.232,00 / **7.790,00**

Visiona Stool

Verner Panton, 1970/2012

vitra.

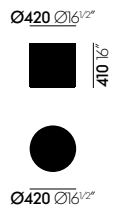

Upholstery: polyurethane foam with polystyrene core and polyester filling.

Base: MDF board with felt glides.

Visiona Stool

	Article no.	without VAT in SEK*	with VAT in SEK*
	210 424 00		
Fabric F40		4.200,00	5.250,00
Fabric F60		4.680,00	5.850,00
Fabric F100		5.960,00	7.450,00

Fabric F40

. Laser RE

Fabric F60

. Hopsak
. Twill
. Volo

Fabric F100

. Tonus

Wiggle Side Chair & Wiggle Stool

Frank Gehry, 1972



Wiggle Side Chair

Structure: corrugated cardboard.

Edges: hardboard.

Wiggle Side Chair

	Article no.	without VAT in SEK*	with VAT in SEK*
natural	210 186 01	9.440,00	11.800,00

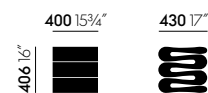

Wiggle Stool

Structure: corrugated cardboard.

Edges: hardboard.

Wiggle Stool

	Article no.	without VAT in SEK*	with VAT in SEK*
natural	210 226 01	5.032,00	6.290,00

Storage and partition elements



Eames Storage Unit ESU
Charles & Ray Eames
392



Living Tower
Verner Panton
393

Office and conference chairs (swivel)

Chairs

Tables

Desks

Public waiting areas

Lounge chairs and armchairs

Sofas

Coffee and side tables

Stools and benches

Storage and partition elements

Accessories

Living, dining, decorative objects, home office,
clocks, lighting, publications

Quick Ship programme

General terms, conditions
and information



Eames Storage Unit ESU

Charles & Ray Eames, 1949

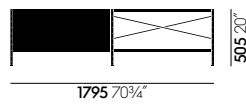
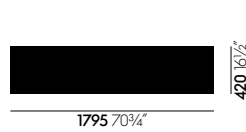

ESU Shelf - 1 HU

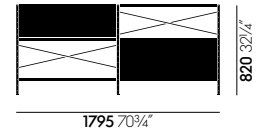
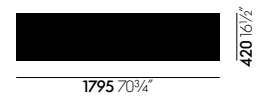

ESU Shelf - 2 HU

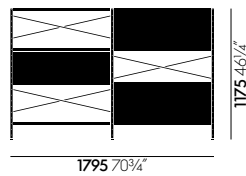
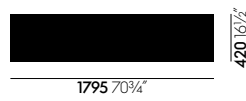
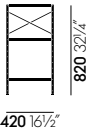

ESU Shelf - 3 HU

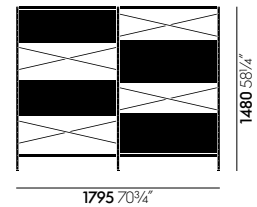

ESU Shelf - 4 HU

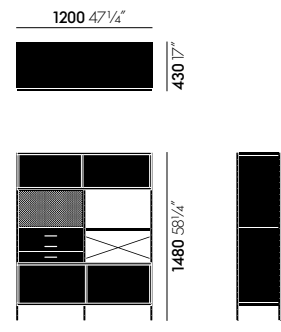
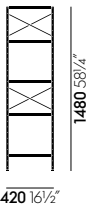

ESU Bookcase

Metal surfaces: black powder-coated finish.

Shelves: birch plywood with maple face veneer (Poland and Finland), transparent lacquer finish.

Panels: powder-coated aluminium.

Legs: individual levelling adjustment.

Applications: recommended for domestic use only.

ESU Shelf

	Article no.	without VAT in SEK*	with VAT in SEK*
1 HU	213 024 11	16.760,00	20.950,00
2 HU	213 024 12	20.760,00	25.950,00
3 HU	213 024 13	25.080,00	31.350,00
4 HU	213 024 14	27.800,00	34.750,00

ESU Bookcase

	Article no.	without VAT in SEK*	with VAT in SEK*
	213 026 11	27.960,00	34.950,00

Publications



Vitra Design Museum
482

Office and conference chairs (swivel)

Chairs

Tables

Desks

Public waiting areas

Lounge chairs and armchairs

Sofas

Coffee and side tables

Stools and benches

Storage and partition elements

Accessories

Living, dining, decorative objects, home office,
clocks, lighting and publications

Quick Ship programme

General terms, conditions
and information



Coat Dots

Hella Jongerius, 2013



Ø50 02



50-75 2-3

Balls: beech wood, painted in various colours.

Wall mount: aluminium.

Product contents: 3 balls, incl. screws and wall plugs for installation.

Origin of wood: beech (*Fagus sylvatica*) from Western Europe and/or Poland.



Coat Dots

set of 3, green

201 164 02

SEK* 760,00 / **950,00**



Coat Dots

set of 3, red

201 164 01

SEK* 760,00 / **950,00**



Coat Dots

set of 3, white

201 164 03

SEK* 760,00 / **950,00**

Corniches

Ronan & Erwan Bouroullec, 2012

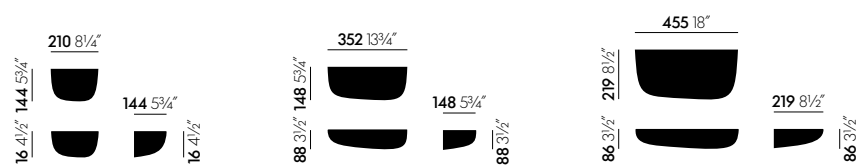

Shell: ASA plastic, high-gloss surface.

Wall bracket: polyamide.

Packaging: premium gift box.



Corniches small

white

215 060 01

SEK* 632,00 / 790,00



Corniches small

orange

215 060 04

SEK* 632,00 / 790,00



Corniches small

Japanese red

215 060 03

SEK* 632,00 / 790,00



Corniches small

khaki

215 060 06

SEK* 632,00 / 790,00



Corniches small

dark grey

215 060 05

SEK* 632,00 / 790,00



Corniches small

black

215 060 02

SEK* 632,00 / 790,00



Corniches medium

white

215 061 01

SEK* 872,00 / 1.090,00



Corniches medium

orange

215 061 04

SEK* 872,00 / 1.090,00



Corniches medium

Japanese red

215 061 03

SEK* 872,00 / 1.090,00



Corniches medium

khaki

215 061 06

SEK* 872,00 / 1.090,00



Corniches medium

dark grey

215 061 05

SEK* 872,00 / 1.090,00



Corniches medium

black

215 061 02

SEK* 872,00 / 1.090,00



Corniches large

white

215 062 01

SEK* 952,00 / 1.190,00



Corniches large

orange

215 062 04

SEK* 952,00 / 1.190,00



Corniches large

Japanese red

215 062 03

SEK* 952,00 / 1.190,00



Corniches large

khaki

215 062 06

SEK* 952,00 / 1.190,00



Corniches large

dark grey

215 062 05

SEK* 952,00 / 1.190,00



Corniches large

black

215 062 02

SEK* 952,00 / 1.190,00



Hang it all

Charles & Ray Eames, 1953

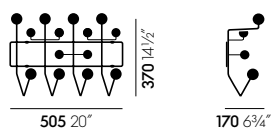

Frame: coated steel wire.

Balls: painted wood, various colours.

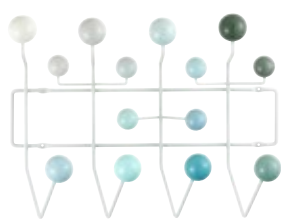

Hang it all

White, multi-tone

201 191 03

SEK* 2.680,00 / **3.350,00**

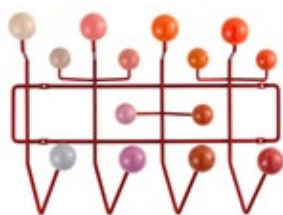

Hang it all

Red, multi-tone

201 191 01

SEK* 2.680,00 / **3.350,00**

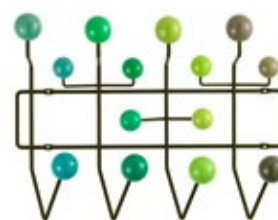

Hang it all

Green, multi-tone

201 191 02

SEK* 2.680,00 / **3.350,00**



Hang it all

White, multi-coloured

201 190 01

SEK* 2.680,00 / **3.350,00**

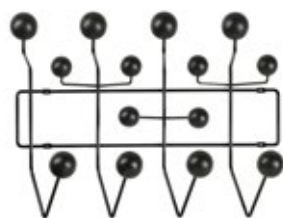

Hang it all

Black, black ash

201 191 04

SEK* 2.680,00 / **3.350,00**

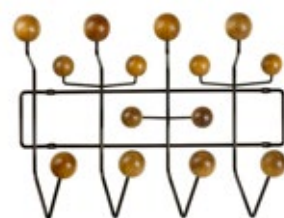

Hang it all

Chocolate, walnut

201 191 05

SEK* 2.680,00 / **3.350,00**

Limited Edition, as long as stock lasts

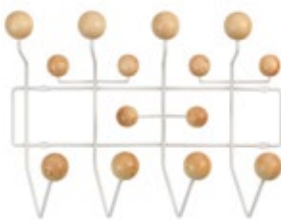

Hang it all

White, pine

201 191 06

SEK* 2.680,00 / **3.350,00**

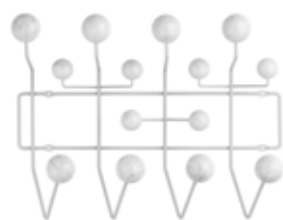

Hang it all

Soft grey, marble

201 191 07

SEK* 12.760,00 / **15.950,00**

Rayonnage Mural

Jean Prouvé, 1936

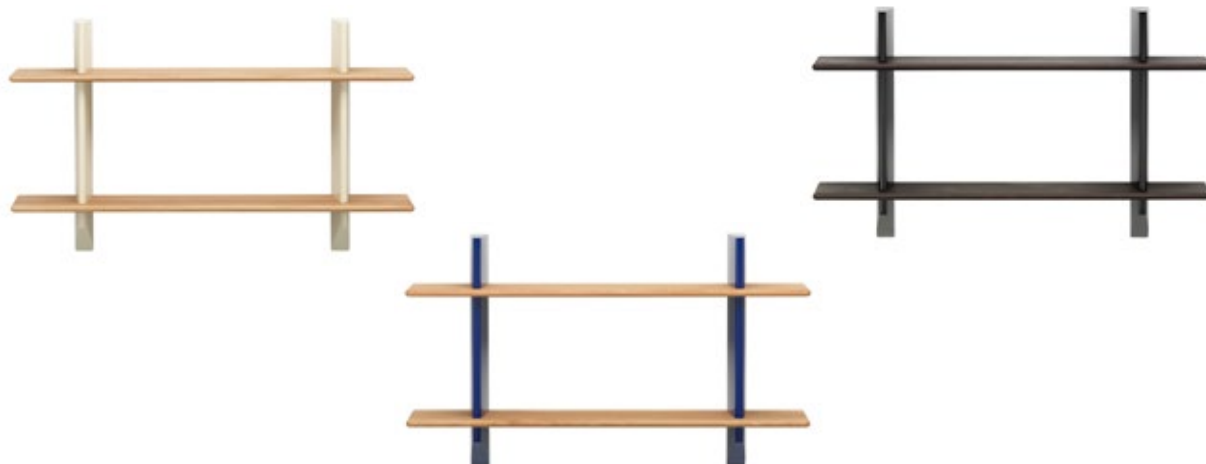

Wall brackets: bent sheet steel, powder-coated finish. Includes wall mounts in aluminium.

Shelves: solid natural oak with oiled finish or solid dark stained oak with clear protective lacquer finish.

Dimensions

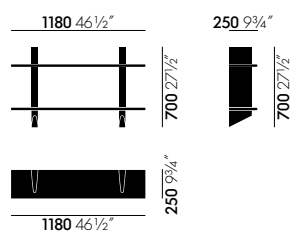

Rayonnage Mural

Rayonnage Mural

Jean Prouvé, 1936



Rayonnage Mural

deep black,
dark solid oak

213 027 02

SEK* 13.280,00 / **16.600,00**



Rayonnage Mural

deep black,
natural solid oak

213 027 01

SEK* 13.280,00 / **16.600,00**



Rayonnage Mural

Japanese red,
dark solid oak

213 027 12

SEK* 13.280,00 / **16.600,00**



Rayonnage Mural

Japanese red,
natural solid oak

213 027 11

SEK* 13.280,00 / **16.600,00**



Rayonnage Mural

Prouvé Blanc Colombe (Ecrú),
dark solid oak

213 027 22

SEK* 13.280,00 / **16.600,00**



Rayonnage Mural

Prouvé Blanc Colombe (Ecrú),
natural solid oak

213 027 21

SEK* 13.280,00 / **16.600,00**



Rayonnage Mural

Prouvé Bleu Marcoule,
dark solid oak

213 027 32

SEK* 13.280,00 / **16.600,00**



Rayonnage Mural

Prouvé Bleu Marcoule,
natural solid oak

213 027 31

SEK* 13.280,00 / **16.600,00**

Uten.Silo

Dorothee Becker, 1969

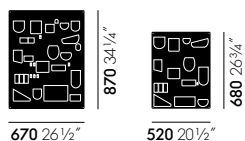

Material: ABS plastic.

Hooks: nickle-plated metal.



Uten.Silo I

white

H 870 x W 670 x D 65 mm

201 290 01

SEK* 3.560,00 / **4.450,00**



Uten.Silo I

black

H 870 x W 670 x D 65 mm

201 290 02

SEK* 3.560,00 / **4.450,00**



Uten.Silo I

red

H 870 x W 670 x D 65 mm

201 290 03

SEK* 3.560,00 / **4.450,00**



Uten.Silo II

white

H 680 x W 520 x D 65 mm

201 295 01

SEK* 2.792,00 / **3.490,00**



Uten.Silo II

black

H 680 x W 520 x D 65 mm

201 295 02

SEK* 2.792,00 / **3.490,00**



Uten.Silo II

red

H 680 x W 520 x D 65 mm

201 295 03

SEK* 2.792,00 / **3.490,00**



Colour Block Blankets

Hella Jongerius, 2016

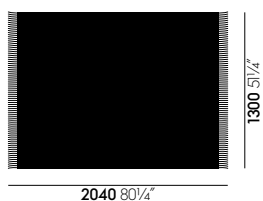

Material: 100% Peruvian highland wool.



Colour Block Blankets

black-blue

2040 x 1300 mm

201 639 03

SEK* 2.520,00 / **3.150,00**



Colour Block Blankets

blue-bordeaux

2040 x 1300 mm

201 639 01

SEK* 2.520,00 / **3.150,00**



Colour Block Blankets

pink-beige

2040 x 1300 mm

201 639 02

SEK* 2.520,00 / **3.150,00**

Eames Wool Blanket

Charles & Ray Eames, 1947

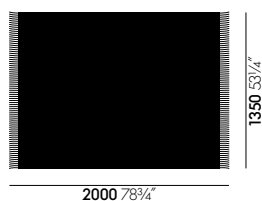

Material: 100% Merino lambswool, produced in a jacquard weave.

Characteristics: Merino lambswool is a high-quality natural fibre obtained from the first shearing of Merino lambs. It is extremely light, fine and soft to the touch while also providing optimal warmth and thermal balance.

Quality: working with premium natural fibres requires considerable technical know-how and manual skill. For this reason, Vitra blankets are made by a German blanket manufacturer with over 100 years of experience in fabricating products from natural fibres. Their expert hand craftsmanship ensures the high-quality execution of the designs.



Eames Wool Blanket

black

1350 x 2000 mm

203 529 99

SEK* 3.672,00 / **4.590,00**



Eames Wool Blanket

light blue

2000 x 1350 mm

203 529 96

SEK* 3.672,00 / **4.590,00**

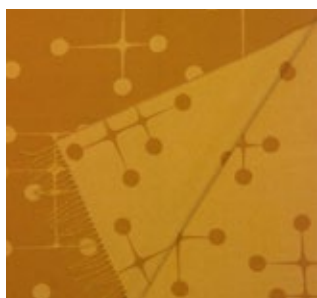

Eames Wool Blanket

mustard

2000 x 1350 mm

203 529 98

SEK* 3.672,00 / **4.590,00**



Eames Wool Blanket

taupe

2000 x 1350 mm

203 529 97

SEK* 3.672,00 / **4.590,00**



Embroidered Pillows

Alexander Girard, 1952



Filling: duck half down.

Cover fabric: Twill, embroidered.



Embroidered Pillows

Home Sweet Home, light grey

H 300 x W 400

201 633 01

SEK* 1.992,00 / **2.490,00**



Embroidered Pillows

Double Heart, red

H 400 x W 400

201 633 06

SEK* 1.992,00 / **2.490,00**



Embroidered Pillows

Double Heart 2, blue

H 300 x W 400

201 633 08

SEK* 1.992,00 / **2.490,00**

Graphic Print Pillows

Alexander Girard, 1961



400 15³/₄"

400 x 300 mm



400 15³/₄"

400 x 400 mm

Fabric: 100% cotton.

Filling: duck half down.



Graphic Print Pillows

International Love Heart

H 400 x W 400 mm

201 657 04

SEK* 840,00 / **1.050,00**



Graphic Print Pillows

Snake, ultramarine

H 400 x W 400 mm

201 657 02

SEK* 840,00 / **1.050,00**



Graphic Print Pillows

Love Heart, crimson

H 400 x W 400 mm

201 657 03

SEK* 840,00 / **1.050,00**



Graphic Print Pillows

Eyes

H 300 x W 400 mm

201 657 01

SEK* 760,00 / **950,00**



Herringbone Pillows

Raw-Edges, 2019

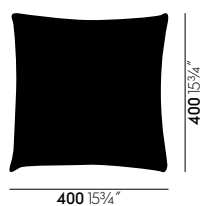

Fabric: 100% cotton.

Filling: duck half down.



Herringbone Pillows

blue

201 381 04

SEK* 872,00 / 1.090,00



Herringbone Pillows

brown

201 381 05

SEK* 872,00 / 1.090,00



Herringbone Pillows

olive

201 381 01

SEK* 872,00 / 1.090,00



Herringbone Pillows

red

201 381 03

SEK* 872,00 / 1.090,00



Herringbone Pillows

yellow

201 381 02

SEK* 872,00 / 1.090,00

Seat Dots

Hella Jongerius, 2016

Material: firm, high-quality fleece pad, Plano fabric cover on both sides, Ø 38 cm.



Seat Dots

parchment/cream white
tobacco/cream white

201 622 01

SEK* 472,00 / 590,00



Seat Dots

yellow/pastel green
parchment/cream white

201 622 02

SEK* 472,00 / 590,00



Seat Dots

cream white/sierra grey
light grey/ice blue

201 622 03

SEK* 472,00 / 590,00



Seat Dots

pink/sierra grey
light grey/sierra grey

201 622 04

SEK* 472,00 / 590,00



Seat Dots

coconut/forest
forest/sierra grey

201 622 05

SEK* 472,00 / 590,00



Seat Dots

red/poppy red
orange

201 622 06

SEK* 472,00 / 590,00



Seat Dots

red/coconut
poppy red

201 622 07

SEK* 472,00 / 590,00



Seat Dots

classic green/forest
classic green/cognac

201 622 08

SEK* 472,00 / 590,00



Seat Dots

mint/forest
petrol/nero

201 622 09

SEK* 472,00 / 590,00



Seat Dots

nero/ice blue
petrol/nero

201 622 10

SEK* 472,00 / 590,00



Seat Dots

blue/coconut
nero/ice blue

201 622 11

SEK* 472,00 / 590,00



Seat Dots

dark grey/nero
marron/nero

201 622 12

SEK* 472,00 / 590,00



Seat Dots

nero/cream white
sierra grey/nero

201 622 13

SEK* 472,00 / 590,00



Seat Dots

dark red/nero
dark red/ice blue

201 622 14

SEK* 472,00 / 590,00





Soft Seats type A



Soft Seats type B

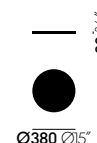

Soft Seats type C

Padding: thermopressed polyester fleece, 2-cm thick, 100% recyclable.

Cover: removable, in fabric or leather, with zip fastener (always in black). Can be professionally dry cleaned.

Note: Soft Seats with non-slip coating can only be used on one side.

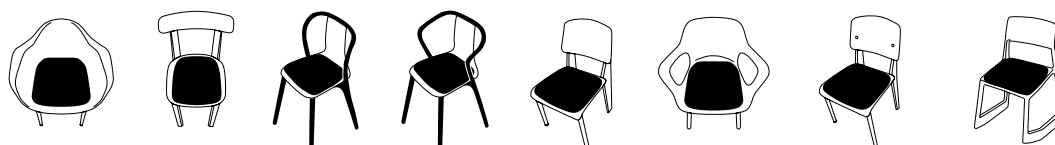

Eames Fiberglass & Plastic Armchair

All Plastic Chair

Belleville Chair

Belleville Armchair

Chaise Tout Bois

HAL Armchair

Standard Standard SP

Tip Ton

Soft Seats type A - set of 3

	Article no.	without VAT in SEK*	with VAT in SEK*
	201 625 00		
both sides with fabric cover			
	00		
Fabric F30		1.896,00	2.370,00
Fabric F40		2.136,00	2.670,00
Fabric F60		2.376,00	2.970,00
Fabric F80		2.640,00	3.300,00
Fabric F120		3.480,00	4.350,00
one side with non-slip coating			
	01		
Fabric F30		1.896,00	2.370,00
Fabric F40		2.136,00	2.670,00
Fabric F60		2.376,00	2.970,00
Fabric F80		2.640,00	3.300,00
Fabric F120		3.480,00	4.350,00
Leather L20		3.960,00	4.950,00
Leather L50		4.536,00	5.670,00

Fabric F30	Fabric F40	Fabric F60	Fabric F80	Fabric F120	Leather L20	Leather L50
· Plano	· Laser RE	· Hopsak	· Corsaro	· Credo	· Leather	· Leather Premium F
		· Twill	· Cosy 2			
		· Volo	· Dumet			
			· Iroko 2			
			· Tress			



Eames Fiberglass & Plastic Sidechair



HAL

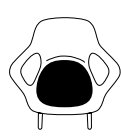

HAL Armchair



Panton & Panton Classic



EVO-C



Wire Chair

Soft Seats type B - set of 3

	Article no.	without VAT in SEK*	with VAT in SEK*
	201 626 00		
both sides with fabric cover	00		
Fabric F30		1.896,00	2.370,00
Fabric F40		2.136,00	2.670,00
Fabric F60		2.376,00	2.970,00
Fabric F80		2.640,00	3.300,00
Fabric F120		3.480,00	4.350,00
one side with non-slip coating	01		
Fabric F30		1.896,00	2.370,00
Fabric F40		2.136,00	2.670,00
Fabric F60		2.376,00	2.970,00
Fabric F80		2.640,00	3.300,00
Fabric F120		3.480,00	4.350,00
Leather L20		3.960,00	4.950,00
Leather L50		4.536,00	5.670,00



All Plastic Chair



Belleville Chair



Belleville Armchair



Chaise Tout Bois



HAL

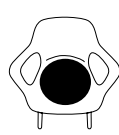

HAL Armchair

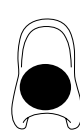

Panton & Panton Classic



Moca



Tip Ton

Soft Seats type C - set of 3

	Article no.	without VAT in SEK*	with VAT in SEK*
	201 627 00		
both sides with fabric cover	00		
Fabric F30		1.896,00	2.370,00
Fabric F40		2.136,00	2.670,00
Fabric F60		2.376,00	2.970,00
Fabric F80		2.640,00	3.300,00
Fabric F120		3.480,00	4.350,00
one side with non-slip coating	01		
Fabric F30		1.896,00	2.370,00
Fabric F40		2.136,00	2.670,00
Fabric F60		2.376,00	2.970,00
Fabric F80		2.640,00	3.300,00
Fabric F120		3.480,00	4.350,00
Leather L20		3.960,00	4.950,00
Leather L50		4.536,00	5.670,00

Fabric F30	Fabric F40	Fabric F60	Fabric F80	Fabric F120	Leather L20	Leather L50
Plano	Laser RE	<ul style="list-style-type: none"> . Hopsak . Twill . Volo 	<ul style="list-style-type: none"> . Corsaro . Cosy 2 . Dumet . Iroko 2 . Tress 	Credo	Leather	Leather Premium F



Note: available as single cushions preconfigured in a limited range of fabrics and colours for fast delivery or in sets of three with a larger choice of fabrics and colours but longer delivery times.

Soft Seats type A – single cushions	Non-slip coating on one side	Article no.	without VAT in SEK*	with VAT in SEK*
Plano 87 nero/cream white		201 625 01	632,00	790,00
Plano 74 sierra grey/nero		201 625 02	632,00	790,00
Plano 05 cream white/sierra grey		201 625 03	632,00	790,00
Plano 03 parchment/cream white		201 625 04	632,00	790,00
Plano 12 light grey/ice blue		201 625 05	632,00	790,00
Hopsak 24 dark grey/nero		201 625 06	792,00	990,00
Hopsak 05 dark grey		201 625 07	792,00	990,00
Hopsak 23 nero/ivory		201 625 08	792,00	990,00
Hopsak 81 ice blue/ivory		201 625 09	792,00	990,00
Hopsak 79 warm grey/ivory		201 625 10	792,00	990,00
Hopsak 20 green/ivory		201 625 75	792,00	990,00
Hopsak 17 nude/ivory		201 625 76	792,00	990,00
Hopsak 83 blue/ivory		201 625 77	792,00	990,00
Hopsak 16 yellow/ivory		201 625 78	792,00	990,00
Hopsak 18 mustard/ivory		201 625 79	792,00	990,00
Hopsak 68 pink/poppy red		201 625 80	792,00	990,00
Cosy 2 11 merino black		201 625 11	880,00	1.100,00
Cosy 2 10 classic grey		201 625 12	880,00	1.100,00
Cosy 2 01 pebble grey		201 625 13	880,00	1.100,00
Cosy 2 02 fossil		201 625 14	880,00	1.100,00
Cosy 2 12 pale blue		201 625 15	880,00	1.100,00
Dumet 33 carbon/black		201 625 16	880,00	1.100,00
Dumet 32 sierra grey melange		201 625 17	880,00	1.100,00
Dumet 28 sage/steel blue		201 625 18	880,00	1.100,00
Dumet 06 pebble melange		201 625 19	880,00	1.100,00
Dumet 01 ivory melange		201 625 20	880,00	1.100,00
Laser RE 13 stone grey		201 625 23	712,00	890,00
Laser RE 65 ice blue/cream		201 625 24	712,00	890,00
Laser RE 03 dark grey		201 625 25	712,00	890,00
Laser RE 20 ice blue/moor brown		201 625 26	712,00	890,00
Laser RE 63 warm grey/cream		201 625 27	712,00	890,00
Corsaro 13 black melange		201 625 28	880,00	1.100,00
Corsaro 12 graphite melange		201 625 29	880,00	1.100,00
Corsaro 08 sierra melange		201 625 30	880,00	1.100,00
Corsaro 01 pale blue melange		201 625 31	880,00	1.100,00
Corsaro 05 stone melange		201 625 32	880,00	1.100,00
Leather Premium F 67 asphalt		201 625 33	1.512,00	1.890,00
Leather Premium F 65 granite		201 625 34	1.512,00	1.890,00
Leather Premium F 73 clay		201 625 35	1.512,00	1.890,00

Note: available as single cushions preconfigured in a limited range of fabrics and colours for fast delivery or in sets of three with a larger choice of fabrics and colours but longer delivery times.

Soft Seats type B – single cushions	Non-slip coating on one side	Article no.	without VAT in SEK*	with VAT in SEK*
Plano 87 nero/cream white		201 626 01	632,00	790,00
Plano 74 sierra grey/nero		201 626 02	632,00	790,00
Plano 05 cream white/sierra grey		201 626 03	632,00	790,00
Plano 03 parchment/cream white		201 626 04	632,00	790,00
Plano 12 light grey/ice blue		201 626 05	632,00	790,00
<hr/>				
Hopsak 24 dark grey/nero		201 626 06	792,00	990,00
Hopsak 05 dark grey		201 626 07	792,00	990,00
Hopsak 23 nero/ivory		201 626 08	792,00	990,00
Hopsak 81 ice blue/ivory		201 626 09	792,00	990,00
Hopsak 79 warm grey/ivory		201 626 10	792,00	990,00
Hopsak 20 green/ivory		201 626 75	792,00	990,00
Hopsak 17 nude/ivory		201 626 76	792,00	990,00
Hopsak 83 blue/ivory		201 626 77	792,00	990,00
Hopsak 16 yellow/ivory		201 626 78	792,00	990,00
Hopsak 18 mustard/ivory		201 626 79	792,00	990,00
Hopsak 68 pink/poppy red		201 626 80	792,00	990,00
<hr/>				
Cosy 2 11 merino black		201 626 11	880,00	1.100,00
Cosy 2 10 classic grey		201 626 12	880,00	1.100,00
Cosy 2 01 pebble grey		201 626 13	880,00	1.100,00
Cosy 2 02 fossil		201 626 14	880,00	1.100,00
Cosy 2 12 pale blue		201 626 15	880,00	1.100,00
<hr/>				
Dumet 33 carbon/black		201 626 16	880,00	1.100,00
Dumet 32 sierra grey melange		201 626 17	880,00	1.100,00
Dumet 28 sage/steel blue		201 626 18	880,00	1.100,00
Dumet 06 pebble melange		201 626 19	880,00	1.100,00
Dumet 01 ivory melange		201 626 20	880,00	1.100,00
<hr/>				
Laser RE 13 stone grey		201 626 23	712,00	890,00
Laser RE 65 ice blue/cream		201 626 24	712,00	890,00
Laser RE 03 dark grey		201 626 25	712,00	890,00
Laser RE 20 ice blue/moor brown		201 626 26	712,00	890,00
Laser RE 63 warm grey/cream		201 626 27	712,00	890,00
<hr/>				
Corsaro 13 black melange		201 626 28	880,00	1.100,00
Corsaro 12 graphite melange		201 626 29	880,00	1.100,00
Corsaro 08 sierra melange		201 626 30	880,00	1.100,00
Corsaro 01 pale blue melange		201 626 31	880,00	1.100,00
Corsaro 05 stone melange		201 626 32	880,00	1.100,00
<hr/>				
Leather Premium F 67 asphalt		201 626 33	1.512,00	1.890,00
Leather Premium F 65 granite		201 626 34	1.512,00	1.890,00
Leather Premium F 73 clay		201 626 35	1.512,00	1.890,00



Note: available as single cushions preconfigured in a limited range of fabrics and colours for fast delivery or in sets of three with a larger choice of fabrics and colours but longer delivery times.

Soft Seats type C – single cushions	Non-slip coating on one side	Article no.	without VAT in SEK*	with VAT in SEK*
Plano 87 nero/cream white		201 627 01	632,00	790,00
Plano 74 sierra grey/nero		201 627 02	632,00	790,00
Plano 05 cream white/sierra grey		201 627 03	632,00	790,00
Plano 03 parchment/cream white		201 627 04	632,00	790,00
Plano 12 light grey/ice blue		201 627 05	632,00	790,00
Hopsak 24 dark grey/nero		201 627 06	792,00	990,00
Hopsak 05 dark grey		201 627 07	792,00	990,00
Hopsak 23 nero/ivory		201 627 08	792,00	990,00
Hopsak 81 ice blue/ivory		201 627 09	792,00	990,00
Hopsak 79 warm grey/ivory		201 627 10	792,00	990,00
Hopsak 20 green/ivory		201 627 75	792,00	990,00
Hopsak 17 nude/ivory		201 627 76	792,00	990,00
Hopsak 83 blue/ivory		201 627 77	792,00	990,00
Hopsak 16 yellow/ivory		201 627 78	792,00	990,00
Hopsak 18 mustard/ivory		201 627 79	792,00	990,00
Hopsak 68 pink/poppy red		201 627 80	792,00	990,00
Cosy 2 11 merino black		201 627 11	880,00	1.100,00
Cosy 2 10 classic grey		201 627 12	880,00	1.100,00
Cosy 2 01 pebble grey		201 627 13	880,00	1.100,00
Cosy 2 02 fossil		201 627 14	880,00	1.100,00
Cosy 2 12 pale blue		201 627 15	880,00	1.100,00
Dumet 33 carbon/black		201 627 16	880,00	1.100,00
Dumet 32 sierra grey melange		201 627 17	880,00	1.100,00
Dumet 28 sage/steel blue		201 627 18	880,00	1.100,00
Dumet 06 pebble melange		201 627 19	880,00	1.100,00
Dumet 01 ivory melange		201 627 20	880,00	1.100,00
Laser RE 13 stone grey		201 627 23	712,00	890,00
Laser RE 65 ice blue/cream		201 627 24	712,00	890,00
Laser RE 03 dark grey		201 627 25	712,00	890,00
Laser RE 20 ice blue/moor brown		201 627 26	712,00	890,00
Laser RE 63 warm grey/cream		201 627 27	712,00	890,00
Corsaro 13 black melange		201 627 28	880,00	1.100,00
Corsaro 12 graphite melange		201 627 29	880,00	1.100,00
Corsaro 08 sierra melange		201 627 30	880,00	1.100,00
Corsaro 01 pale blue melange		201 627 31	880,00	1.100,00
Corsaro 05 stone melange		201 627 32	880,00	1.100,00
Leather Premium F 67 asphalt		201 627 33	1.512,00	1.890,00
Leather Premium F 65 granite		201 627 34	1.512,00	1.890,00
Leather Premium F 73 clay		201 627 35	1.512,00	1.890,00

Soft Seats Outdoor

2023

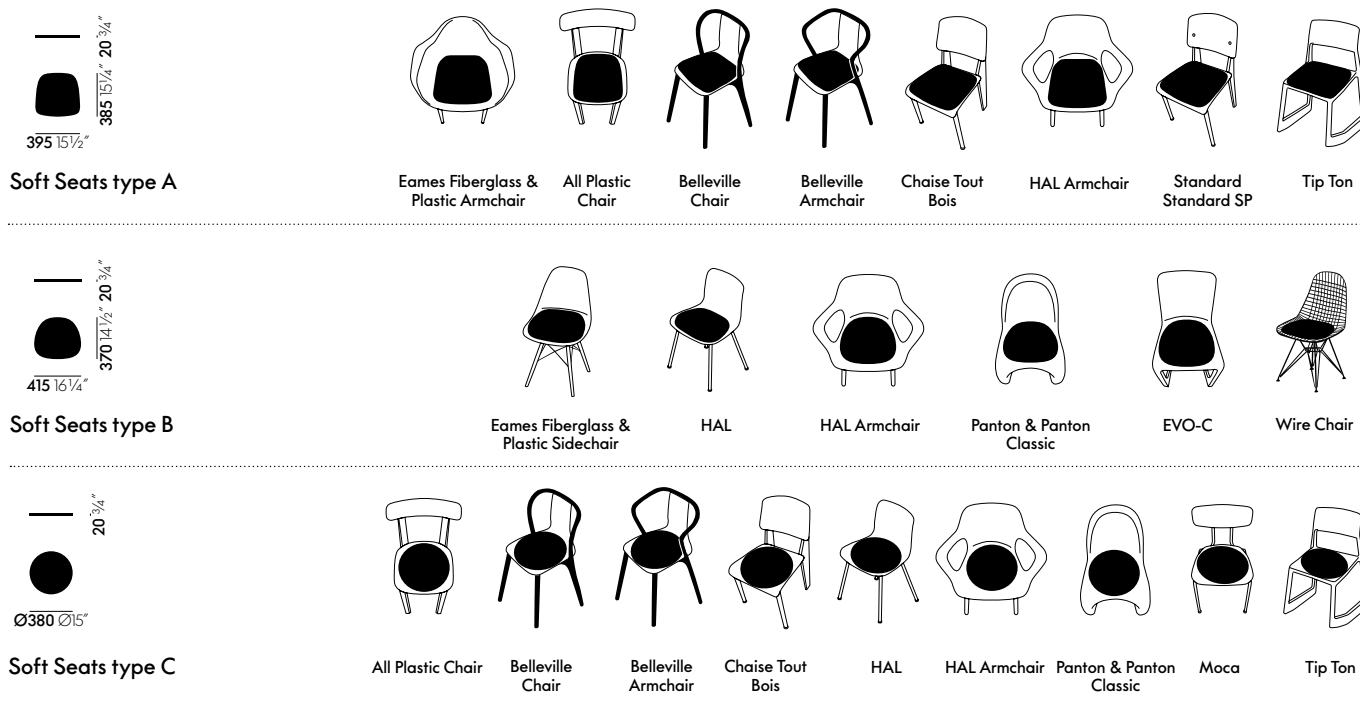

Materials

Upholstery: padding made of polyurethane foam for outdoor use, 2-cm thick (Oeko-Tex).

Cover: water-repellent outdoor fabric, with zip fastener (always in black), removable. Cover can be washed at 30 degrees.

Note: always with non-slip fabric on reverse side.

Soft Seats Outdoor type A - single cushions

	Article no.	without VAT in SEK*	with VAT in SEK*
Simmons 53 white/steel blue	201 625 69	960,00	1.200,00
Simmons 55 grey/white	201 625 70	960,00	1.200,00
Simmons 61 grey	201 625 71	960,00	1.200,00

Soft Seats Outdoor type B - single cushions

	Article no.	without VAT in SEK*	with VAT in SEK*
Simmons 53 white/steel blue	201 626 69	960,00	1.200,00
Simmons 55 grey/white	201 626 70	960,00	1.200,00
Simmons 61 grey	201 626 71	960,00	1.200,00

Soft Seats Outdoor type C - single cushions

	Article no.	without VAT in SEK*	with VAT in SEK*
Simmons 53 white/steel blue	201 627 69	960,00	1.200,00
Simmons 55 grey/white	201 627 70	960,00	1.200,00
Simmons 61 grey	201 627 71	960,00	1.200,00



Algue

Ronan & Erwan Bouroullec, 2004

vitra.

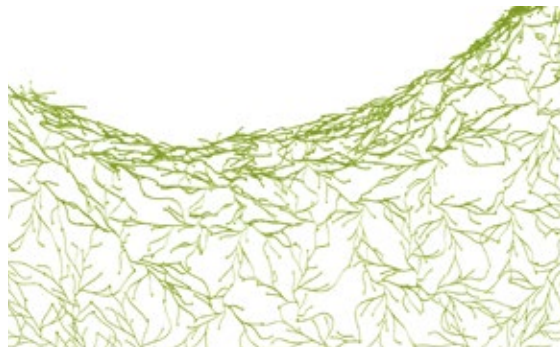

Material: injection-moulded plastic.

Items per package: 25 pieces (approx. 1 m²).

Algue		Article no.	without VAT in SEK*	with VAT in SEK*
white	25-item pack	215 047 01	1.160,00	1.450,00
black	25-item pack	215 047 02	1.160,00	1.450,00
green	25-item pack	215 047 03	1.160,00	1.450,00
red	25-item pack	215 047 04	1.160,00	1.450,00
light green	25-item pack	215 047 05	1.160,00	1.450,00

Eames Elephant

Charles & Ray Eames, 1945

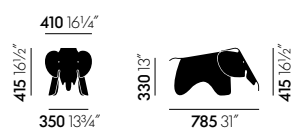

Material: dyed-through polypropylene, matt finish.



Eames Elephant

white

215 029 01

SEK* 2.392,00 / **2.990,00**



Eames Elephant

deep black

215 029 12

SEK* 2.392,00 / **2.990,00**



Eames Elephant

ice grey

215 029 02

SEK* 2.392,00 / **2.990,00**



Eames Elephant

buttercup

215 029 09

SEK* 2.392,00 / **2.990,00**



Eames Elephant

palm green

215 029 07

SEK* 2.392,00 / **2.990,00**



Eames Elephant

pale rose

215 029 10

SEK* 2.392,00 / **2.990,00**



Eames Elephant

poppy red

215 029 08

SEK* 2.392,00 / **2.990,00**

Eames Elephant (Plywood)

Charles & Ray Eames, 1945

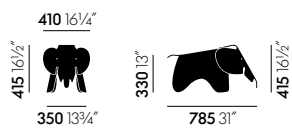

Material: plywood with face veneer in American cherry (USA).

Limited Edition, as long as stock lasts



Eames Elephant (Plywood)

american cherry

210 225 03

SEK* 13.320,00 / **16.650,00**



Eames Elephant (Plywood)

ash grey

210 225 04

SEK* 13.320,00 / **16.650,00**



Eames Elephant (small)

Charles & Ray Eames, 1945

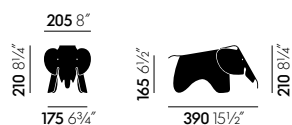

Material: dyed-through polypropylene, matt finish.



Eames Elephant (small)

buttercup

215 112 09

SEK* 792,00 / **990,00**



Eames Elephant (small)

deep black

215 112 12

SEK* 792,00 / **990,00**



Eames Elephant (small)

ice grey

215 112 02

SEK* 792,00 / **990,00**



Eames Elephant (small)

pale rose

215 112 10

SEK* 792,00 / **990,00**



Eames Elephant (small)

palm green

215 112 07

SEK* 792,00 / **990,00**



Eames Elephant (small)

poppy red

215 112 08

SEK* 792,00 / **990,00**



Eames Elephant (small)

white

215 112 01

SEK* 792,00 / **990,00**

Miniatures Collection

Vitra Design Museum, 1820 - 2011



Gartenstuhl
Schinkel, 1820
H 135 x W 80 x D 90
202 517 01
SEK* 2.472,00 / **3.090,00**



Stuhl No. 14
Thonet, 1859/60
H 155 x W 70 x D 85
202 242 01
SEK* 2.600,00 / **3.250,00**



Schaukelsessel No. 9
Kohn & Thonet, 1882
H 175 x W 105 x D 195
202 512 01
SEK* 7.000,00 / **8.750,00**



Hill House 1
Mackintosh, 1903
H 235 x W 65 x D 60
202 001 01
SEK* 2.600,00 / **3.250,00**



Barrel Chair
Wright, 1904
H 140 x W 100 x D 100
202 568 01
SEK* 5.032,00 / **6.290,00**



Sitzmaschine
Hoffmann, 1905
H 185 x W 110 x D 145
202 011 01
SEK* 3.800,00 / **4.750,00**



Rood blauwe stoel
Rietveld, 1918
H 145 x W 110 x D 140
202 031 01
SEK* 2.312,00 / **2.890,00**



B3 Wassily
Breuer, 1925
H 125 x W 125 x D 115
202 041 01
SEK* 2.600,00 / **3.250,00**



Stuhl W1
Stam, 1926
H 140 x W 75 x D 90
202 531 01
SEK* 1.912,00 / **2.390,00**



MR 20
Mies van der Rohe, 1927
H 130 x W 90 x D 145
202 051 01
SEK* 2.600,00 / **3.250,00**



MR 90 Barcelona
Mies van der Rohe, 1929
H 125 x W 125 x D 130
202 514 01
SEK* 4.632,00 / **5.790,00**



Standard Chair
Prouvé, 1930
H 135 x W 70 x D 80
202 527 01
SEK* 2.600,00 / **3.250,00**



Art. 41 'Paimio'
Aalto, 1930/31
H 100 x W 105 x D 145
202 161 01
SEK* 2.232,00 / **2.790,00**



Armchair Nr. 42
Aalto, 1932
H 120 x W 100 x D 120 mm
202 162 01
SEK* 2.232,00 / **2.790,00**



Zig zag stoel
Rietveld, 1934
H 125 x W 60 x D 65
202 071 01
SEK* 1.640,00 / **2.050,00**



Landi Chair
Coray, 1938
H 125 x W 90 x D 105
202 567 01
SEK* 2.792,00 / **3.490,00**



Johnson Wax Chair
Wright, 1939
H 145 x W 100 x D 80
202 502 01
SEK* 3.352,00 / **4.190,00**



Organic Armchair
Eames & Saarinen, 1940
H 155 x W 130 x D 105
202 461 01
SEK* 2.312,00 / **2.890,00**



Miniatures Collection

Vitra Design Museum, 1820 - 2011

vitra.



LCW

Eames, 1945

H 115 x W 90 x D 100

202 084 01

SEK* 2.392,00 / **2.990,00**



DCW

Eames, 1945

H 120 x W 80 x D 90

202 081 02

SEK* 2.392,00 / **2.990,00**



LCM

Eames, 1945

H 110 x W 95 x D 105

202 181 01

SEK* 2.072,00 / **2.590,00**



Plywood Elephant natural

Eames, 1945

H 70 x W 70 x D 130

202 085 02

SEK* 2.072,00 / **2.590,00**



Taliesin West Armchair

Wright, 1946

H 130 x W 155 x D 155

202 569 01

SEK* 3.240,00 / **4.050,00**



Womb Chair & Ottoman

Saarinen, 1946

H 152 x W 158 x D 145

202 575 01

SEK* 5.592,00 / **6.990,00**



La Chaise

Eames, 1948

H 135 x W 250 x D 140

202 401 01

SEK* 3.000,00 / **3.750,00**



RAR

Eames, 1950

H 115 x W 105 x D 110

202 101 05

SEK* 1.912,00 / **2.390,00**



Y-Chair

Wegner, 1950

H 125 x W 85 x D 95

202 507 01

SEK* 3.560,00 / **4.450,00**



Gala

Albini, 1950

H 160 x W 145 x D 180

202 558 01

SEK* 6.632,00 / **8.290,00**



Antony

Prouvé, 1950

H 145 x W 85 x D 115

202 521 01

SEK* 2.600,00 / **3.250,00**



DSW

Eames, 1950

H 135 x W 80 x D 85

202 110 05

SEK* 1.640,00 / **2.050,00**



DKR Wire Chair

Eames, 1951

H 130 x W 80 x D 95

202 191 01

SEK* 2.600,00 / **3.250,00**



Diamond Chair

Bertoia, 1952

H 115 x W 190 x D 135

202 251 01

SEK* 3.160,00 / **3.950,00**



Butterfly Stool

Yanagi, 1954

H 70 x W 80 x D 55

202 513 01

SEK* 1.752,00 / **2.190,00**



Coconut Chair

Nelson, 1955

H 140 x W 160 x D 145

202 491 01

SEK* 2.920,00 / **3.650,00**



Lounge Chair & Ottoman

Eames, 1956

H 135 x W 140 x D 140

202 411 01

SEK* 6.792,00 / **8.490,00**



Tulip Chair

Saarinen, 1956

H 135 x B 85 x T 90

202 519 01

SEK* 2.312,00 / **2.890,00**



Marshmallow Sofa

Nelson, 1956

H 130 x B 220 x T 135

202 547 01

SEK* 6.760,00 / **8.450,00**

Miniatures Collection

Vitra Design Museum, 1820 - 2011

vitra.



Mezzadro
Castiglioni, 1957
H 85 x W 80 x D 90
202 371 01
SEK* 2.072,00 / **2.590,00**



Aluminium Chair
Eames, 1958
H 140 x W 100 x D 100
202 524 01
SEK* 5.992,00 / **7.490,00**



Heart-Shaped Cone Chair
Panton, 1959
H 149 x W 169 x D 100
202 121 01
SEK* 2.760,00 / **3.450,00**



Panton Chairs (Set of 5)
Panton, 1959/60
H 140 x W 85 x D 85
202 131 01
SEK* 1.752,00 / **2.190,00**



Stool (Model A)
Eames, 1960
H 65 x W 55 x D 55
202 564 01
SEK* 1.560,00 / **1.950,00**



Stool (Model B)
Eames, 1960
H 65 x W 55 x D 55
202 564 02
SEK* 1.560,00 / **1.950,00**



Stool (Model C)
Eames, 1960
H 65 x W 55 x D 55
202 564 03
SEK* 1.560,00 / **1.950,00**



3-Benet Skanstol
Wegner, 1963
H 120 x W 155 x D 130
202 201 01
SEK* 2.392,00 / **2.990,00**



Laminated Chair
Jalk, 1963
H 125 x W 105 x D 117
202 573 01
SEK* 4.472,00 / **5.590,00**



Karuselli
Kukkapuro, 1964/65
H 155 x W 140 x D 165
202 563 01
SEK* 6.392,00 / **7.990,00**



Ball Chair
Aarnio, 1965
H 210 x W 190 x D 175
202 381 01
SEK* 3.560,00 / **4.450,00**



Ribbon Chair
Paulin, 1966
H 130 x W 170 x D 120
202 565 01
SEK* 2.552,00 / **3.190,00**



Garden Egg
Ghytczy, 1968
H 175 x W 120 x D 140
202 086 01
SEK* 3.240,00 / **4.050,00**



La Mamma
Gaetano Pesce, 1969
H 150 x W 190 x D 230
202 562 01
SEK* 3.960,00 / **4.950,00**



Bocca
Studio 65, 1970
H 145 x W 355 x D 135
202 530 01
SEK* 2.520,00 / **3.150,00**



Wiggle Side Chair
Gehry, 1972
H 145 x W 65 x D 95
202 301 01
SEK* 1.432,00 / **1.790,00**



Lockheed Lounge
Newson, 1986
H 147 x W 105 x D 275
202 556 01
SEK* 10.040,00 / **12.550,00**



Well Tempered Chair
Arad, 1986
H 130 x W 155 x D 145
202 221 01
SEK* 3.160,00 / **3.950,00**



Little Beaver
Gehry, 1987
H 145 x W 145 x D 150
202 520 01
SEK* 3.240,00 / **4.050,00**

Miniatures Collection

Vitra Design Museum, 1820 - 2011

vitra.



Big Easy

Arad, 1988

H 170 x W 215 x D 130

202 539 01

SEK* 7.640,00 / **9.550,00**



Favela

Campana, 1991

H 125 x W 115 x D 105

202 570 01

SEK* 3.960,00 / **4.950,00**



.02

Van Severen, 1992

H 130 x W 65 x D 95

202 571 01

SEK* 1.672,00 / **2.090,00**



Knotted Chair

Wanders, 1996

H 115 x W 85 x D 100

202 518 01

SEK* 2.600,00 / **3.250,00**



Tom Vac

Arad, 1999

H 130 x W 105 x D 100

202 529 01

SEK* 1.880,00 / **2.350,00**



Vegetal (Set of 3)

Bouroullec, 2008

H 130 x W 101 x D 96

202 572 98

SEK* 1.352,00 / **1.690,00**



Vegetal (Set of 3)

Bouroullec, 2008

H 130 x W 101 x D 96

202 572 97

SEK* 1.352,00 / **1.690,00**



Tip Ton glacier blue

Barber & Osgerby, 2011

H 130 x W 85 x D 93

202 580 02

SEK* 360,00 / **450,00**



Tip Ton (set of 3)

Barber & Osgerby, 2011

H 130 x W 85 x D 93

202 580 01

SEK* 1.192,00 / **1.490,00**



Material: polycarbonate.

Equipment: wireless charger, 2 power connections, 2 USB-A connections, 1 USB-C connection.

Cable length: 1.5 metres.

Ampy		Article no.	without VAT in SEK*	with VAT in SEK*
basic dark	ELE01: DE, AT, NL, ES norm	201 394 01	1.840,00	2.300,00
soft grey	ELE01: DE, AT, NL, ES norm	201 394 02	1.840,00	2.300,00

GST18 plug		Article no.	without VAT in SEK*	with VAT in SEK*
Adapter cable 0.5m	EU standard	201 403 01	224,00	280,00



Chap

Konstantin Grcic, 2021

vitra.



Material: recycled polypropylene, 100% recyclable.



Chap
deep black RE
201 393 01
SEK* 840,00 / 1.050,00



Chap
brick RE
201 393 04
SEK* 840,00 / 1.050,00



Chap
dark grey RE
201 393 02
SEK* 840,00 / 1.050,00



Chap
sea blue RE
201 393 03
SEK* 840,00 / 1.050,00



Chap Tray
deep black RE
201 398 01
SEK* 280,00 / 350,00



Chap Tray
brick RE
201 398 04
SEK* 280,00 / 350,00



Chap Tray
dark grey RE
201 398 02
SEK* 280,00 / 350,00



Chap Tray
sea blue RE
201 398 03
SEK* 280,00 / 350,00

Drop Box

Konstantin Grcic, 2022

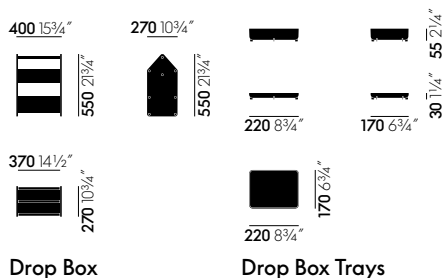

Drop Box

Drop Box Trays

Side panels: recycled polypropylene, 100% recyclable.

Tubes: aluminium.

Fabric: 100% polyester.



Drop Box

deep black RE

H 550 x W 400 x D 270 mm

201 400 01

SEK* 3.112,00 / **3.890,00**



Drop Box

brick RE

H 550 x W 400 x D 270 mm

201 400 04

SEK* 3.112,00 / **3.890,00**



Drop Box

dark grey RE

H 550 x W 400 x D 270 mm

201 400 02

SEK* 3.112,00 / **3.890,00**



Drop Box

sea blue RE

H 550 x W 400 x D 270 mm

201 400 03

SEK* 3.112,00 / **3.890,00**



Drop Box Tray Set

deep black RE

H 30 - 55 x W 220 x D 170 mm

201 401 01

SEK* 400,00 / **500,00**



Drop Box Tray Set

brick RE

H 30 - 55 x W 220 x D 170 mm

201 401 04

SEK* 400,00 / **500,00**



Drop Box Tray Set

dark grey RE

H 30 - 55 x W 220 x D 170 mm

201 401 02

SEK* 400,00 / **500,00**



Drop Box Tray Set

sea blue RE

H 30 - 55 x W 220 x D 170 mm

201 401 03

SEK* 400,00 / **500,00**



Elephant Pad

Hella Jongerius, 2010

250 9½"



Material: high-quality furniture leather (leather remnants from the production of Vitra furniture).



Elephant Pad

nero

215 127 01

SEK* 216,00 / 270,00



Elephant Pad

cognac

215 127 02

SEK* 216,00 / 270,00



Elephant Pad

sand

215 127 03

SEK* 216,00 / 270,00



Elephant Pad

chocolate

215 127 04

SEK* 216,00 / 270,00



Elephant Pad

snow

215 127 05

SEK* 216,00 / 270,00



Elephant Pad

asphalt

215 127 06

SEK* 216,00 / 270,00

Happy Bin

Michel Charlot, 2016

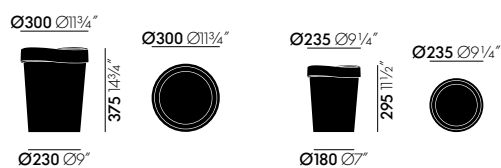

Material: dyed-through polypropylene.



Happy Bin L

basic dark

203 155 01

SEK* 680,00 / **850,00**



Happy Bin L

poppy red

203 155 04

SEK* 680,00 / **850,00**



Happy Bin L

yellow

203 155 05

SEK* 680,00 / **850,00**



Happy Bin L

sky grey

203 155 03

SEK* 680,00 / **850,00**



Happy Bin L

white

203 155 02

SEK* 680,00 / **850,00**



Happy Bin S

basic dark

203 154 01

SEK* 472,00 / **590,00**



Happy Bin S

poppy red

203 154 04

SEK* 472,00 / **590,00**



Happy Bin S

yellow

203 154 05

SEK* 472,00 / **590,00**



Happy Bin S

sky grey

203 154 03

SEK* 472,00 / **590,00**



Happy Bin S

white

203 154 02

SEK* 472,00 / **590,00**



Locker Box

Konstantin Grcic, 2021



Locker Box



Locker Box, small

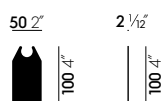

Locker Box Nametag

Side panels: recycled polypropylene, 100% recyclable.

Tubes: aluminium.

Fabric: 100% polyester.



Locker Box
deep black RE
H 330 x W 465 x D 180 mm
201 392 01
SEK* 1.840,00 / **2.300,00**



Locker Box
brick RE
H 330 x W 465 x D 180 mm
201 392 04
SEK* 1.840,00 / **2.300,00**



Locker Box
dark grey RE
H 330 x W 465 x D 180 mm
201 392 02
SEK* 1.840,00 / **2.300,00**



Locker Box
sea blue RE
H 330 x W 465 x D 180 mm
201 392 03
SEK* 1.840,00 / **2.300,00**



Locker Box, small
deep black RE
H 330 x W 365 x D 180 mm
201 402 01
SEK* 1.680,00 / **2.100,00**



Locker Box, small
brick RE
H 330 x W 365 x D 180 mm
201 402 04
SEK* 1.680,00 / **2.100,00**



Locker Box, small
dark grey RE
H 330 x W 365 x D 180 mm
201 402 02
SEK* 1.680,00 / **2.100,00**



Locker Box, small
sea blue RE
H 330 x W 365 x D 180 mm
201 402 03
SEK* 1.680,00 / **2.100,00**



Locker Box Nametag
deep black RE
H 100 x W 50 x D 2 mm
201 399 01
SEK* 96,00 / **120,00**



Locker Box Nametag
brick RE
H 100 x W 50 x D 2 mm
201 399 04
SEK* 96,00 / **120,00**



Locker Box Nametag
dark grey RE
H 100 x W 50 x D 2 mm
201 399 02
SEK* 96,00 / **120,00**



Locker Box Nametag
sea blue RE
H 100 x W 50 x D 2 mm
201 399 03
SEK* 96,00 / **120,00**

Magnet Dots

Hella Jongerius, 2016

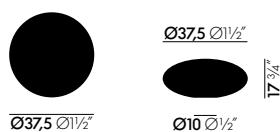

Dots: dyed-through polypropylene.

Magnet: inset ferrite magnet. One magnet can hold up to 5 sheets of paper (DIN A4).

Package contents: 5 Magnet Dots per set.



Magnet Dots

set of 5, bright

215 105 03

SEK* 232,00 / **290,00**



Magnet Dots

set of 5, dark

215 105 04

SEK* 232,00 / **290,00**



Magnet Dots

set of 5, green

215 105 01

SEK* 232,00 / **290,00**



Magnet Dots

set of 5, red

215 105 02

SEK* 232,00 / **290,00**

O-Tidy

Michel Charlot, 2016

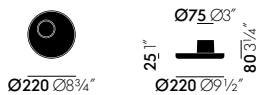

Material: ABS plastic.



O-Tidy
dark grey
203 152 01
SEK* 360,00 / 450,00



O-Tidy
poppy red
203 152 04
SEK* 360,00 / 450,00



O-Tidy
sea blue
203 152 06
SEK* 360,00 / 450,00



O-Tidy
sky grey
203 152 03
SEK* 360,00 / 450,00



O-Tidy
white
203 152 02
SEK* 360,00 / 450,00



O-Tidy
yellow
203 152 05
SEK* 360,00 / 450,00



S-Tidy

Michel Charlot, 2016

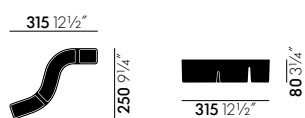

Material: ABS plastic.



S-Tidy
dark grey
203 153 01
SEK* 360,00 / 450,00



S-Tidy
poppy red
203 153 04
SEK* 360,00 / 450,00



S-Tidy
sea blue
203 153 06
SEK* 360,00 / 450,00



S-Tidy
sky grey
203 153 03
SEK* 360,00 / 450,00



S-Tidy
white
203 153 02
SEK* 360,00 / 450,00



S-Tidy
yellow
203 153 05
SEK* 360,00 / 450,00

Repad

Ronan & Erwan Bouroullec, 2023

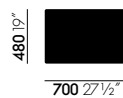

Repad

Material: 100% bonded leather, made up of remnants from Vitra furniture production. Variant in natural hue with protective sealant; colour variants with coated finish.



Repad

clay

203 179 03

SEK* 1.400,00 / **1.750,00**



Repad

light sage

203 179 04

SEK* 1.400,00 / **1.750,00**



Repad

dark red

203 179 05

SEK* 1.400,00 / **1.750,00**



Repad

jade

203 179 06

SEK* 1.400,00 / **1.750,00**



Repad

natural black

203 179 02

SEK* 1.192,00 / **1.490,00**



Toolbox

Arik Levy, 2010

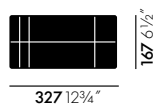

Material: ABS plastic.



Toolbox

white

H 156 x W 327 x D 167 mm

892 550 21

SEK* 312,00 / **390,00**



Toolbox

mint green

H 156 x W 327 x D 167 mm

892 550 16

SEK* 312,00 / **390,00**



Toolbox

pale rose

H 156 x W 327 x D 167 mm

892 550 19

SEK* 312,00 / **390,00**



Toolbox

tangerine

H 156 x W 327 x D 167 mm

892 550 17

SEK* 312,00 / **390,00**



Toolbox

moss grey

H 156 x W 327 x D 167 mm

892 550 18

SEK* 312,00 / **390,00**



Toolbox

sea blue

H 156 x W 327 x D 167 mm

892 550 20

SEK* 312,00 / **390,00**



Toolbox

basic dark

H 156 x W 327 x D 167 mm

892 550 11

SEK* 312,00 / **390,00**

Toolbox RE

Arik Levy, 2021

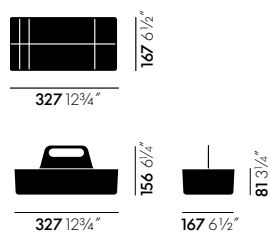

Material for Toolbox RE in diverse colours: post-industrial recycled ABS plastic, 100% recyclable.

Material for Toolbox RE in grey: recycled polypropylene, 100% recyclable.



Toolbox RE

grey RE

H 156 x W 327 x D 167 mm

201 385 01

SEK* 312,00 / **390,00**



Toolbox RE

mint green RE

H 156 x W 327 x D 167 mm

201 391 16

SEK* 312,00 / **390,00**



Toolbox RE

pale rose RE

H 156 x W 327 x D 167 mm

201 391 19

SEK* 312,00 / **390,00**



Toolbox RE

tangerine RE

H 156 x W 327 x D 167 mm

201 391 17

SEK* 312,00 / **390,00**



Toolbox RE

moss grey RE

H 156 x W 327 x D 167 mm

201 391 18

SEK* 312,00 / **390,00**



Toolbox RE

sea blue RE

H 156 x W 327 x D 167 mm

201 391 20

SEK* 312,00 / **390,00**



Toolbox RE

basic dark RE

H 156 x W 327 x D 167 mm

201 391 11

SEK* 312,00 / **390,00**



Desk Clocks

George Nelson, 1947/1953

Materials: brass, acrylic glass, polyurethane, solid walnut.

Product contents: high-quality quartz clock movement, 1.5 volt battery included.

Origin of wood: walnut (*Juglans nigra*) from Western Europe and/or Poland.



Tripod Clock

brass, acrylic glass

H 165 x W 110 x D 85

215 020 01

SEK* 3.912,00 / **4.890,00**



Night Clock

brass, acrylic glass

H 148 x W 108 x D 115

215 021 01

SEK* 3.672,00 / **4.590,00**



Night Clock

brass, black, acrylic glass

H 148 x W 108 x D 115

215 067 01

SEK* 4.040,00 / **5.050,00**



Diamond Clock

solid walnut

H 175 x W 255 x D 140

215 032 01

SEK* 4.440,00 / **5.550,00**



Cone Clock

Polyurethane

H 170 x W 150 x D 155

215 034 01

SEK* 3.432,00 / **4.290,00**



Chronopak

Walnut veneer

H 169 x W 115 x D 115

215 068 01

SEK* 4.632,00 / **5.790,00**



Cone Base Clock

powder-coated sheet metal

H 171 x W 135 x D 62

215 069 01

SEK* 3.752,00 / **4.690,00**

Wall Clocks

George Nelson, 1948-1960

Materials: various types of wood and metal.

Product contents: high-quality quartz clock movement, 1.5 volt battery included.

Origin of wood: all wood types from Poland, except the Fan Clock: American cherry (Prunus serotina) from USA.



Ball Clock

orange

Ø 330

201 250 01

SEK* 2.792,00 / **3.490,00**



Ball Clock

beech

Ø 330

201 250 02

SEK* 2.792,00 / **3.490,00**



Ball Clock

multicoloured

Ø 330

201 250 03

SEK* 2.792,00 / **3.490,00**



Ball Clock

red

Ø 330

201 250 05

SEK* 2.792,00 / **3.490,00**



Ball Clock

black/brass

Ø 330

201 250 06

SEK* 3.592,00 / **4.490,00**



Ball Clock

cherry

Ø 330

201 250 07

SEK* 3.592,00 / **4.490,00**



Sunburst Clock

multicoloured

Ø 470

201 253 01

SEK* 3.832,00 / **4.790,00**



Sunburst Clock

red

Ø 470

201 253 02

SEK* 3.832,00 / **4.790,00**



Sunburst Clock

walnut

Ø 470

201 253 03

SEK* 3.832,00 / **4.790,00**



Sunburst Clock

black/brass

Ø 470

201 253 05

SEK* 3.832,00 / **4.790,00**



Asterisk Clock

black

Ø 250

201 252 01

SEK* 2.712,00 / **3.390,00**



Asterisk Clock

brass

Ø 250

201 252 03

SEK* 3.240,00 / **4.050,00**



Fan Clock

cherry (USA)

Ø 384

201 624 01

SEK* 4.232,00 / **5.290,00**



Popsicle Clock

walnut

Ø 350

201 263 01

SEK* 7.160,00 / **8.950,00**



Wall Clocks

George Nelson, 1948-1960



Polygon Clock

walnut

Ø 430

201 618 01

SEK* 5.160,00 / **6.450,00**



Petal Clock

black/brass

Ø 448

201 260 02

SEK* 3.752,00 / **4.690,00**



Wheel Clock

walnut/aluminium

Ø 455

201 619 01

SEK* 4.232,00 / **5.290,00**



Spindle Clock

walnut/brass

Ø 577

215 011 03

SEK* 4.232,00 / **5.290,00**



Star Clock

chrome/brass

Ø 610

201 259 01

SEK* 3.752,00 / **4.690,00**



Flock of Butterflies

aluminium

Ø 610

201 617 01

SEK* 7.960,00 / **9.950,00**



Diamond Markers Clock

white

Ø 335

201 266 01

SEK* 6.600,00 / **8.250,00**



Sunflower Clock

birch

Ø 750

201 256 01

SEK* 10.360,00 / **12.950,00**



Sunflower Clock

black ash/brass

Ø 750

201 256 02

SEK* 11.160,00 / **13.950,00**



Turbine Clock

brass/aluminium

Ø 765

201 255 01

SEK* 6.200,00 / **7.750,00**



Eye Clock

brass/walnut

H 340 x W 760

201 257 01

SEK* 3.752,00 / **4.690,00**

Zoo Timers

George Nelson, 1965

Material: plywood, multicoloured print.

Hands: sheet metal.

Product contents: high-quality quartz clock movement, 1.5 volt battery included.



Omar the Owl

multicoloured print

H 255 x W 270 x D 35

215 004 01

SEK* 1.352,00 / **1.690,00**



Elihu the Elephant

multicoloured print

H 255 x W 270 x D 35

215 004 02

SEK* 1.352,00 / **1.690,00**



Fernando the Fish

multicoloured print

H 250 x W 280 x D 35

215 004 04

SEK* 1.352,00 / **1.690,00**



Akari Light Sculptures

Isamu Noguchi, 1951



Akari Light Sculptures

Lampshades: washi paper, some partially painted. Some models with end pieces in wood/bamboo.

Structure: bamboo/steel wire.

Legs: painted steel wire.

Light source: 4W LED

Socket: E27

Dimmability: not dimmable.

Kelvin: 2700 K (warm white).

Plug: Euro flat, 2-pin (type C plug).

Max. watt: 12W

Energy efficiency: E

Cable length for table lamps: 130 cm.

Cable length for floor lamps: 300 cm.

Cable length for ceiling lamps: 220 cm.

Akari Light Sculptures

Isamu Noguchi, 1951

vitra.



1A
H 430 x W 250 x D 250
201 570 01
SEK* 2.760,00 / **3.450,00**



1AD
H 430 x W 260 x D 260
201 570 02
SEK* 3.192,00 / **3.990,00**



1AG
H 430 x W 260 x D 260
201 571 01
SEK* 3.192,00 / **3.990,00**



1AY
H 430 x W 260 x D 260
201 570 03
SEK* 3.192,00 / **3.990,00**



1N
H 390 x W 250 x D 250
201 572 01
SEK* 2.760,00 / **3.450,00**



3X
H 380 x W 230 x D 230
201 578 01
SEK* 2.712,00 / **3.390,00**



20N
H 630 x W 420 x D 420
201 574 01
SEK* 4.200,00 / **5.250,00**



24N
H 580 x W 400 x D 400
201 658 01
SEK* 5.560,00 / **6.950,00**



UF1-H
H 510 x W 200 x D 200
201 546 01
SEK* 4.200,00 / **5.250,00**



3A
H 560 x W 280 x D 280
201 577 01
SEK* 5.480,00 / **6.850,00**



3AD
H 560 x W 250 x D 250
201 585 01
SEK* 5.672,00 / **7.090,00**



9AD
H 620 x W 440 x D 440
201 586 01
SEK* 5.960,00 / **7.450,00**



7A
H 630 x W 300 x D 300
201 648 01
SEK* 5.960,00 / **7.450,00**



9A
H 620 x W 440 x D 440
201 649 01
SEK* 5.960,00 / **7.450,00**



YA2
H 510 x W 360 x D 360
201 593 01
SEK* 3.432,00 / **4.290,00**

All dimensions in mm.
Prices excl./incl. VAT

* recommended retail price

1/2023 (SE-EN)

475



Akari Light Sculptures

Isamu Noguchi, 1951

vitra.



UF4-33N

H 1900 x W 470 x D 470

201 559 01

SEK* 17.400,00 / **21.750,00**



UF4-L8

H 1880 x W 410 x D 410

201 562 01

SEK* 16.920,00 / **21.150,00**



UF4-L10

H 1930 x W 480 x D 480

201 560 01

SEK* 17.640,00 / **22.050,00**



BB3-55DD

H 1850 x W 530 x D 530

201 537 01

SEK* 20.120,00 / **25.150,00**



BB3-33S

H 1700 x W 750 x D 250

201 536 01

SEK* 23.400,00 / **29.250,00**



UF3-Q

H 1450 x W 560 x D 560

201 557 01

SEK* 10.200,00 / **12.750,00**



10A

H 1230 x W 530 x D 530

201 530 01

SEK* 6.872,00 / **8.590,00**



13A

H 1360 x W 490 x D 490

201 591 01

SEK* 8.760,00 / **10.950,00**



14A

H 1580 x W 510 x D 510

201 531 01

SEK* 10.040,00 / **12.550,00**



25N

H 1170 x W 830 x D 830

201 659 01

SEK* 16.920,00 / **21.150,00**

Akari Light Sculptures

Isamu Noguchi, 1951

vitra.



45A
H 450 x W 450 x D 450
201 508 01
SEK* 3.192,00 / **3.990,00**



55A
H 550 x W 550 x D 550
201 509 01
SEK* 3.832,00 / **4.790,00**



75A
H 750 x W 750 x D 750
201 510 01
SEK* 10.520,00 / **13.150,00**



120A
H 1200 x W 1200 x D 1200
201 511 01
SEK* 27.000,00 / **33.750,00**



55D
H 520 x W 550 x D 550
201 515 01
SEK* 3.512,00 / **4.390,00**



75D
H 690 x W 740 x D 740
201 516 01
SEK* 8.440,00 / **10.550,00**



26A
H 250 x W 450 x D 450
201 507 01
SEK* 3.192,00 / **3.990,00**



21A
H 280 x W 650 x D 650
201 506 01
SEK* 5.160,00 / **6.450,00**



15A
H 330 x W 880 x D 880
201 505 01
SEK* 9.160,00 / **11.450,00**



50EN
H 250 x W 500 x D 500
201 518 01
SEK* 3.832,00 / **4.790,00**



70EN
H 330 x W 700 x D 700
201 519 01
SEK* 5.912,00 / **7.390,00**



23A
H 700 x W 320 x D 320
201 583 01
SEK* 3.672,00 / **4.590,00**



45X
H 430 x W 430 x D 430
201 525 01
SEK* 3.912,00 / **4.890,00**



33N
H 1600 x W 470 x D 470
201 522 01
SEK* 8.680,00 / **10.850,00**



E
H 2950 x W 480 x D 480
201 527 01
SEK* 21.960,00 / **27.450,00**



16A
H 280 x W 520 x D 480
201 650 01
SEK* 5.512,00 / **6.890,00**



YP1
H 380 x W 500 x D 500
201 592 01
SEK* 4.600,00 / **5.750,00**

All dimensions in mm.
Prices excl./incl. VAT

* recommended retail price

1/2023 (SE-EN)

477



Lampe de Bureau

Jean Prouvé, 1930

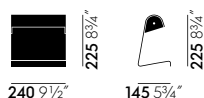

Material: powder-coated sheet steel, 1 bulb included.

Socket: E14.

Light source: Osram Candle, frosted.

Dimmability: no dimmer.

Kelvin: 2700 K (warm white).

Plug: Euro flat 2-pin (type C plug), UK 3-pin (type G plug) or US 2-pin (type A plug).

Cable length: from cable outlet to switch 50 cm, from switch to plug 200 cm.

Max. watt: 12 W.

Energy efficiency: F

Lampe de Bureau

		Article no.	without VAT in SEK*	with VAT in SEK*
Japanese red	220-240 V, 50/60 Hz, Plug Type C	201 264 01	2.632,00	3.290,00
deep black	220-240 V, 50/60 Hz, Plug Type C	201 264 02	2.632,00	3.290,00
mint	220-240 V, 50/60 Hz, Plug Type C	201 264 03	2.632,00	3.290,00
Prouvé Blanc Colombe (Ecrú)	220-240 V, 50/60 Hz, Plug Type C	201 264 04	2.632,00	3.290,00
Prouvé Bleu Marcoule	220-240 V, 50/60 Hz, Plug Type C	201 264 05	2.632,00	3.290,00

Potence

Jean Prouvé, 1947/1950

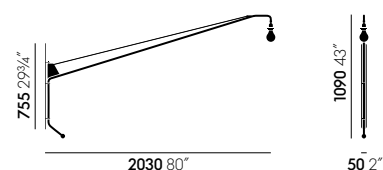

Material: powder-coated tubular steel, oakwood handle, cord dimmer, 1 bulb included.

Socket: E27.

Light source: Porcelain III, LED Globe 125 mm.

Dimmability: dimmer.

Kelvin: 2700 K (warm white).

Plug: Euro flat 2-pin (type C plug), UK 3-pin (type G plug) or US 2-pin (type A plug).

Cable length: from cable outlet to dimmer 75 cm, from dimmer to plug 300 cm.

Max. watt: 12 W.

Energy efficiency: F

Potence		Article no.	without VAT in SEK*	with VAT in SEK*
deep black	220-240 V, 50/60 Hz, Plug Type C	412 399 00	12.760,00	15.950,00
Prouvé Blanc Colombe (Ecrú)	220-240V, 50/60 Hz, Plug Type C	412 399 02	12.760,00	15.950,00



Petite Potence

Jean Prouvé, 1947

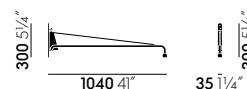

Material: powder-coated tubular steel, cord dimmer, 1 bulb included.

Socket: E27.

Light source: Porcelain II, LED Globe 80 mm.

Dimmability: dimmer.

Kelvin: 2700 K (warm white).

Plug: Euro flat 2-pin (type C plug), UK 3-pin (type G plug) or US 2-pin (type A plug).

Cable length: from cable outlet to dimmer 95 cm, from dimmer to plug 300 cm.

Max. watt: 12 W.

Energy efficiency: F

Petite Potence		Article no.	without VAT in SEK*	with VAT in SEK*
Japanese red	220-240 V, 50/60 Hz, Plug Type C	201 265 01	8.600,00	10.750,00
deep black	220-240 V, 50/60 Hz, Plug Type C	201 265 02	8.600,00	10.750,00
Prouvé Blanc Colombe (Ecrú)	220-240V, 50/60 Hz, Plug Type C	201 265 03	8.600,00	10.750,00
Prouvé Bleu Marcoule	220-240V, 50/60Hz, Plug Type C	201 265 04	8.600,00	10.750,00

Abat-Jour Conique

Jean Prouvé, 1947

vitra.



Potence with Abat-Jour Conique



Petite Potence with Abat-Jour Conique



- **Material:** steel wire, powder-coated. Fabric cover made of brushed cotton in white, with plastic backing.
- **Product contents:** lampshade and light bulb.
- **Light bulb type E27:** LED Superstar Classic, A75, dimmable, E27
- **Energy efficiency:** F

Abat-Jour Conique

Abat-Jour Conique (E27)

Article no.	without VAT in SEK*	with VAT in SEK*
201 297 01	3.112,00	3.890,00



Le Corbusier

German text

200 186 01

SEK* 339,62 / **360,00**



Grow your own house

German / English Text

200 165 09

SEK* 207,55 / **220,00**



Fernando & Humberto Campana

German / English text

200 803 01

SEK* 301,89 / **320,00**



Rudolf Steiner

Die Alchemie des Alltags

German text

200 805 01

SEK* 745,28 / **790,00**



Gerrit Rietveld

Die Revolution des Raums

German text

200 527 01

SEK* 698,11 / **740,00**



Louis Kahn

The Power of Architecture

German text

200 807 01

SEK* 745,28 / **790,00**



Pop Art Design

German text

200 808 01

SEK* 650,94 / **690,00**



Lightopia

German text

200 529 01

SEK* 745,28 / **790,00**



Lightopia

English text

200 529 02

SEK* 745,28 / **790,00**

Konstantin Grcic

Panorama

German text

200 530 01

SEK* 650,94 / **690,00**



Konstantin Grcic

Panorama

English text

200 530 02

SEK* 650,94 / **690,00**

Making Africa

German text

200 213 01

SEK* 650,94 / **690,00**



Making Africa

English text

200 213 02

SEK* 650,94 / **690,00**

Making Africa

Spanish text

200 213 04

SEK* 650,94 / **690,00**

Das Bauhaus

#allesistdesign

German text

200 214 01

SEK* 650,94 / **690,00**



The Lucky, Plucky Chairs

German text

200 083 01

SEK* 141,51 / **150,00**



The Lucky, Plucky Chairs

English text

200 083 02

SEK* 141,51 / **150,00**

Alexander Girard

A Designer's Universe

German text

200 215 01

SEK* 650,94 / **690,00**



Das Vitra Schaudepot

Architektur, Idee, Objekte

German text

200 810 01

SEK* 141,51 / **150,00**



The Vitra Schaudepot

Architecture, Ideas, Objects

English text

200 810 02

SEK* 141,51 / **150,00**

Hello, Robot.

1st edition 2017

English text

200 809 02

SEK* 462,26 / **490,00**



Together!

The New Architecture of the Collective

English text

200 811 02

SEK* 462,26 / **490,00**



Essential Eames

Zitate & Bilder

German text

200 812 01

SEK* 268,87 / **285,00**



Essential Eames

Words & Pictures

English text

200 812 02

SEK* 268,87 / **285,00**

Eames Furniture Sourcebook

German text

200 813 01

SEK* 462,26 / **490,00**



Eames Furniture Sourcebook

English text

200 813 02

SEK* 462,26 / **490,00**

Typecasting

English text

200 223 02

SEK* 235,85 / **250,00**



Night Fever

Design und Klubkultur

German text

200 219 01

SEK* 556,60 / **590,00**



Alexander Girard

La Fonda del Sol

Colouring Book

200 218 02

SEK* 94,34 / **100,00**

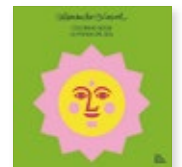

Victor Papanek

The Politics of Design

German text

200 220 01

SEK* 556,60 / **590,00**



Victor Papanek

The Politics of Design

English text

200 220 02

SEK* 556,60 / **590,00**

Objekte der Begierde

Surrealismus und Design 1924 – heute

German text

200 815 01

SEK* 556,60 / **590,00**



Objects of Desire

Surrealism and Design 1924 – Today

English text

200 815 02

SEK* 556,60 / **590,00**

Home Stories

100 Jahre, 20 visionäre Interieurs

German text

200 226 01

SEK* 556,60 / **590,00**



Home Stories

100 Years, 20 Visionary Interiors

English text

200 226 02

SEK* 556,60 / **590,00**



Der Vitra Campus

Architektur Design Industrie

German text

203 178 01

SEK* 254,72 / **270,00**



The Vitra Campus

Architecture Design Industry

English text

203 178 02

SEK* 254,72 / **270,00**

Space Fantasies 1:1

R.F. Collection

English text

200 228 02

SEK* 1.471,70 / **1.560,00**



Deutsches Design 1949 – 1989

Zwei Länder, eine Geschichte

German text

200 471 01

SEK* 556,60 / **590,00**



German Design 1949 – 1989

Two Countries, One History

English text

200 471 02

SEK* 556,60 / **590,00**

Atlas des Möbeldesigns

German text

200 814 01

SEK* 1.556,60 / **1.650,00**



Atlas of Furniture Design

English text

200 814 02

SEK* 1.556,60 / **1.650,00**

Baranger Motion Displays

R.F. Collection

English text

200 531 01

SEK* 415,09 / **440,00**

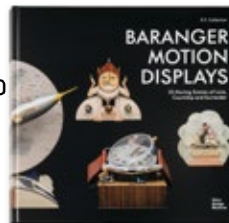

Plastik. Die Welt neu entdecken

German text

200 533 01

SEK* 462,26 / **490,00**

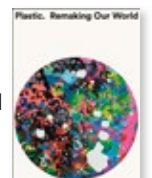

Plastic. Remaking Our World

English text

200 533 02

SEK* 462,26 / **490,00**

Hello, Robot.

2nd, extended edition 2022

German text

200 532 01

SEK* 462,26 / **490,00**



Hello, Robot.

2nd, extended edition 2022

English text

200 532 02

SEK* 462,26 / **490,00**

Robots 1:2

R.F. Collection

English text

200 229 02

SEK* 294,34 / **312,00**



Kazuo Shinohara

The Umbrella House Project

English text

200 817 01

SEK* 294,34 / **312,00**



R.F. Robot Collection

Poster

205 504 31

SEK* 184,00 / 230,00

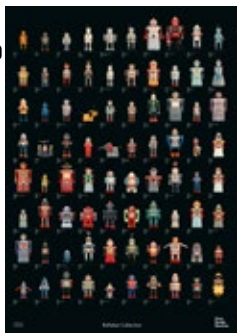

The Chair Collection 2022

Poster

205 508 01

SEK* 184,00 / 230,00



Poster Bouroullec (Multicolor)

Ronan Bouroullec

205 504 32

SEK* 456,00 / 570,00



Poster Bouroullec (Bicolor)

Ronan Bouroullec

205 504 33

SEK* 456,00 / 570,00



Poster Bouroullec (Green)

Ronan Bouroullec

205 504 34

SEK* 456,00 / 570,00



Poster Bouroullec (Orange)

Ronan Bouroullec

205 504 35

SEK* 456,00 / 570,00



Bag "Atlas des Möbeldesigns"

Bag

200 225 01

SEK* 112,00 / 140,00



Quick Ship programme



DSR Fiberglass
Charles & Ray Eames
488



DSW Fiberglass
Charles & Ray Eames
488



DAR
Charles & Ray Eames
489



DAW
Charles & Ray Eames
489



DSR
Charles & Ray Eames
490



DSW
Charles & Ray Eames
490



Panton Chair
Verner Panton
491



AM Chair
Alberto Meda
491



ID Mesh
Antonio Citterio
492



ID Soft
Antonio Citterio
492



Physix
Alberto Meda
493



Rookie
Konstantin Grcic
493

The chapter 'Quick Ship programme' lists products available with a fast delivery. Their article numbers begin with 'QS'.

Vitra delivers standard order quantities from stock. Items sent with standard packing are dispatched in the next scheduled shipment, involving no extra cost.

Items can be ordered in the Online Sales Configurator <https://salesconfigurator.vitra.com/> provided stocks are available, and the respective delivery times can be checked. However, if the daily quota is exhausted, no delivery times will be shown.

Other versions, special orders and stock orders are not available through the Quick Ship programme.

All products in the Quick Ship programme are identified in the price list by a lorry symbol. 

Office and conference chairs (swivel)

Chairs

Tables

Desks

Public waiting areas

Lounge chairs and armchairs

Sofas

Coffee and side tables

Stools and benches

Storage and partition elements

Accessories

Living, dining, decorative objects, home office, clocks, lighting, publications

Quick Ship programme

General terms, conditions
and information





Quick Ship programme

Various Designers

vitra.

Dining Chairs

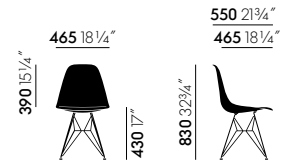

All measurements are pursuant to EN 1335-1:2000

More detailed information is found in the chapter 'Explanation of measurements'.

Eames Fiberglass Side Chair DSR, seat shell in colour Eames Elephant Hide Grey		Article no.	without VAT in SEK*	with VAT in SEK*
Base powder-coated in basic dark (smooth)	Felt glides for hard floors in basic dark	QS4 040 0A	5.928,00	7.410,00
Base powder-coated in basic dark (smooth)	Carpet glides in basic dark	QS4 040 0C	5.928,00	7.410,00

Eames Fiberglass Side Chair DSR, shell colour Eames Sea Foam Green		Article no.	without VAT in SEK*	with VAT in SEK*
Base powder-coated in basic dark (smooth)	Felt glides for hard floors in basic dark	QS4 040 0B	5.928,00	7.410,00
Base powder-coated in basic dark (smooth)	Carpet glides in basic dark	QS4 040 0D	5.928,00	7.410,00

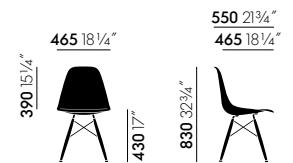

All measurements are pursuant to EN 1335-1:2000

More detailed information is found in the chapter 'Explanation of measurements'.

Eames Fiberglass Side Chair DSW, shell colour Eames Elephant Hide Grey		Article no.	without VAT in SEK*	with VAT in SEK*
Base in black maple	Felt glides for hard floors in basic dark	QS4 040 5A	7.400,00	9.250,00
Base in black maple	Carpet glides in basic dark	QS4 040 5E	7.400,00	9.250,00
Base in dark maple	Felt glides for hard floors in basic dark	QS4 040 5B	7.400,00	9.250,00
Base in dark maple	Carpet glides in basic dark	QS4 040 5F	7.400,00	9.250,00

Eames Fiberglass Side Chair DSW, shell colour Eames Sea Foam Green		Article no.	without VAT in SEK*	with VAT in SEK*
Base in black maple	Felt glides for hard floors in basic dark	QS4 040 5C	7.400,00	9.250,00
Base in black maple	Carpet glides in basic dark	QS4 040 5G	7.400,00	9.250,00
Base in dark maple	Felt glides for hard floors in basic dark	QS4 040 5D	7.400,00	9.250,00
Base in dark maple	Carpet glides in basic dark	QS4 040 5H	7.400,00	9.250,00



Quick Ship programme

Various Designers

vitra.

Dining Chairs

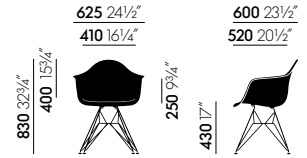

All measurements are pursuant to EN 1335-1:2000

More detailed information is found in the chapter 'Explanation of measurements'.

Eames Plastic Armchair DAR, shell colour white

		Article no.	without VAT in SEK*	with VAT in SEK*
chrome-plated base	Felt glides for hard floors in basic dark	QS4 032 0A	4.088,00	5.110,00
Chrome-plated base	Carpet glides in basic dark	QS4 032 0C	4.088,00	5.110,00

Eames Plastic Armchair DAR, shell colour deep black

		Article no.	without VAT in SEK*	with VAT in SEK*
chrome-plated base	Felt glides for hard floors in basic dark	QS4 032 0B	4.088,00	5.110,00
chrome-plated base	Carpet glides in basic dark	QS4 032 0D	4.088,00	5.110,00

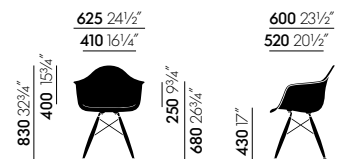

All measurements are pursuant to EN 1335-1:2000

More detailed information is found in the chapter 'Explanation of measurements'.

Eames Plastic Armchair DAW, shell colour white

		Article no.	without VAT in SEK*	with VAT in SEK*
Base in honey-toned ash	Felt glides for hard floors in basic dark	QS4 032 5A	5.896,00	7.370,00
Base in honey-toned ash	Carpet glides in basic dark	QS4 032 5F	5.896,00	7.370,00
Base in golden maple	Felt glides for hard floors in basic dark	QS4 032 5B	5.560,00	6.950,00
Base in golden maple	Carpet glides in basic dark	QS4 032 5E	5.560,00	6.950,00

Eames Plastic Armchair DAW, shell colour deep black

		Article no.	without VAT in SEK*	with VAT in SEK*
Base in honey-toned ash	Felt glides for hard floors in basic dark	QS4 032 5C	5.896,00	7.370,00
Base in honey-toned ash	Carpet glides in basic dark	QS4 032 5H	5.896,00	7.370,00
Base in golden maple	Felt glides for hard floors in basic dark	QS4 032 5D	5.560,00	6.950,00
Base in golden maple	Carpet glides in basic dark	QS4 032 5G	5.560,00	6.950,00





Quick Ship programme

Various Designers

vitra.

Dining Chairs



All measurements are pursuant to EN 1335-1:2000

More detailed information is found in the chapter 'Explanation of measurements'.

Eames Plastic Side Chair DSR, shell colour white

		Article no.	without VAT in SEK*	with VAT in SEK*
Chrome-plated base	Felt glides for hard floors in basic dark	QS4 030 0A	2.952,00	3.690,00
Chrome-plated base	Carpet glides in basic dark	QS4 030 0C	2.952,00	3.690,00

Eames Plastic Side Chair DSR, shell colour deep black

		Article no.	without VAT in SEK*	with VAT in SEK*
Chrome-plated base	Felt glides for hard floors in basic dark	QS4 030 0B	2.952,00	3.690,00
Chrome-plated base	Carpet glides in basic dark	QS4 030 0D	2.952,00	3.690,00

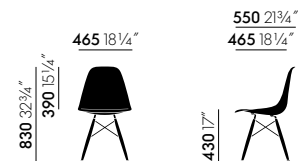

All measurements are pursuant to EN 1335-1:2000

More detailed information is found in the chapter 'Explanation of measurements'.

Eames Plastic Side Chair DSW, shell colour white

		Article no.	without VAT in SEK*	with VAT in SEK*
Base in honey-toned ash	Felt glides for hard floors in basic dark	QS4 030 5B	4.760,00	5.950,00
Base in honey-toned ash	Carpet glides in basic dark	QS4 030 5F	4.760,00	5.950,00
Base in golden maple	Felt glides for hard floors in basic dark	QS4 030 5A	4.424,00	5.530,00
Base in golden maple	Carpet glides in basic dark	QS4 030 5E	4.424,00	5.530,00

Eames Plastic Side Chair DSW, shell colour deep black

		Article no.	without VAT in SEK*	with VAT in SEK*
Base in honey-toned ash	Felt glides for hard floors in basic dark	QS4 030 5D	4.760,00	5.950,00
Base in honey-toned ash	Carpet glides in basic dark	QS4 030 5H	4.760,00	5.950,00
Base in golden maple	Felt glides for hard floors in basic dark	QS4 030 5C	4.424,00	5.530,00
Base in golden maple	Carpet glides in basic dark	QS4 030 5G	4.424,00	5.530,00



Quick Ship programme

Various Designers

vitra.

Dining Chairs

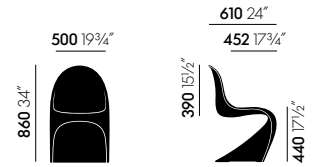

All measurements are pursuant to EN 1335-1:2000
More detailed information is found in the chapter 'Explanation of measurements'.

Panton Chair

	Article no.	without VAT in SEK*	with VAT in SEK*
Chair in white	QS4 003 5A	3.032,00	3.790,00

Task Chairs

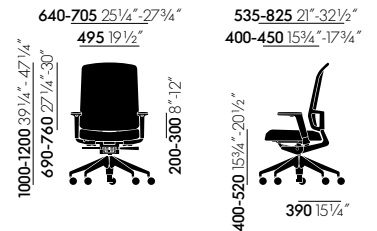

All measurements are pursuant to EN 1335-1:2000
More detailed information is found in the chapter 'Explanation of measurements'.

AM Chair, seat cover in Plano nero, back cover in LightNet black

		Article no.	without VAT in SEK*	with VAT in SEK*
Hard braked castors for carpet	ProMotion mechanism with seat depth adjustment, no forward tilt, armrests and back frame in deep black, 2D-armrests, plastic base in deep black	QS1 705 0A	8.000,00	10.000,00
Soft braked castors for hard floors	ProMotion mechanism with seat depth adjustment, no forward tilt, armrests and back frame in deep black, 2D-armrests, plastic base in deep black	QS1 705 0B	8.000,00	10.000,00





Quick Ship programme

Various Designers

vitra.

Task Chairs

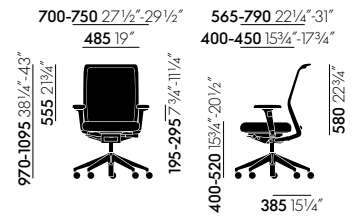

All measurements are pursuant to EN 1335-1:2000
More detailed information is found in the chapter 'Explanation of measurements'.

ID Mesh, seat cover in Plano nero, back cover in Diamond Mesh nero		Article no.	without VAT in SEK*	with VAT in SEK*
Hard braked castors for carpet	FlowMotion mechanism with forward tilt and seat depth adjustment; frame in colour basic dark; 2D armrests F, polished aluminium; five-star base in plastic, basic dark	QS3 140 1A	9.376,00	11.720,00
Soft braked castors for hard floors	FlowMotion mechanism with forward tilt, with seat depth adjustment; frame in colour basic dark; 2D armrests F, polished aluminium; five-star base in plastic, basic dark	QS3 140 1B	9.376,00	11.720,00

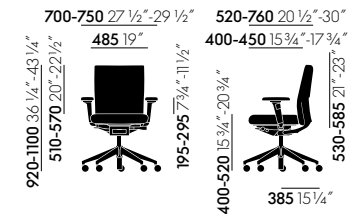

All measurements are pursuant to EN 1335-1:2000
More detailed information is found in the chapter 'Explanation of measurements'.

ID Soft, seat and backrest covers in Plano nero		Article no.	without VAT in SEK*	with VAT in SEK*
Hard braked castors for carpet	FlowMotion mechanism with forward tilt and seat depth adjustment; frame in colour basic dark; 2D armrests F, polished aluminium; five-star base in plastic, basic dark	QS3 140 2A	10.360,00	12.950,00
Soft braked castors for hard floors	FlowMotion mechanism with forward tilt and seat depth adjustment; frame in colour basic dark; 2D armrests F, polished aluminium; five-star base in plastic, basic dark	QS3 140 2B	10.360,00	12.950,00



Quick Ship programme

Various Designers

vitra.

Task Chairs

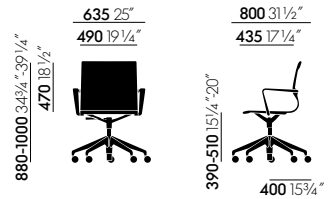

All measurements are pursuant to EN 1335-1:2000
More detailed information is found in the chapter 'Explanation of measurements'.

Physix, cover material TrioKnit, black pearl		Article no.	without VAT in SEK*	with VAT in SEK*
Hard braked castors for carpet	Five-star aluminium base in deep black, frame and mechanical unit in deep black	QS1 721 0A	10.272,00	12.840,00
Soft braked castors for hard floors	Five-star aluminium base in deep black, frame and mechanical unit in deep black	QS1 721 0B	10.272,00	12.840,00

Physix, cover material TrioKnit, silver grey		Article no.	without VAT in SEK*	with VAT in SEK*
Hard braked castors for carpet	Five-star aluminium base in soft grey, frame and mechanical unit in soft grey	QS1 721 0E	10.272,00	12.840,00
Soft braked castors for hard floors	Five-star aluminium base in soft grey, frame and mechanical unit in soft grey	QS1 721 0F	10.272,00	12.840,00

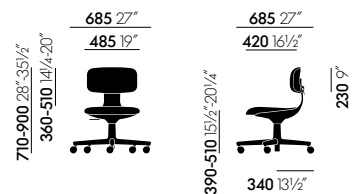

All measurements are pursuant to EN 1335-1:2000
More detailed information is found in the chapter 'Explanation of measurements'.

Rookie, cover material Plano, nero		Article no.	without VAT in SEK*	with VAT in SEK*
Hard braked castors for carpet	Shell colour deep black, five-star plastic base in deep black	QS1 901 1B	4.408,00	5.510,00
Soft braked castors for hard floors	Shell colour deep black, five-star plastic base in deep black	QS1 901 1A	4.408,00	5.510,00

Rookie, cover material Plano, cream white/sierra grey		Article no.	without VAT in SEK*	with VAT in SEK*
Hard braked castors for carpet	Shell colour soft grey, five-star plastic base in soft grey	QS1 901 1D	4.408,00	5.510,00
Soft braked castors for hard floors	Shell colour soft grey, five-star plastic base in soft grey	QS1 901 1C	4.408,00	5.510,00





Office and conference chairs (swivel)

Chairs

Tables

- 497 Overview of cover materials
- 500 Explanation of measurements
- 502 Distribution rights
- 503 General Conditions of Sale and Delivery

Desks

Public waiting areas

Lounge chairs and armchairs

Sofas

Coffee and side tables

Stools and benches

Storage and partition elements

Accessories

Living, dining, decorative objects, home office,
clocks, lighting, publications

Quick Ship programme

General terms, conditions
and information



Overview of cover materials

Textiles with a price group

Fabric orders in full metres only.

Price group	without VAT in SEK / lin. m	Article no.	Material	Width	Weight	
F2o	950.00	Nova	62304800	100% polyester	142 cm +/- 2 cm	400 g/m ²
		Vinyl Valencia	62308900	22% polyester, 78% PVC	137 cm	650 g/m ²
F3o	1120.00	Plano	62303900	100% polyester	142 cm +/- 2 cm	265 g/m ²
F4o	1240.00	Laser RE	63100600	100% recycled polyester	144 cm +/- 2 cm	520 g/m ²
		Mello	62407700	80% cotton, 20% polyester	142 cm +/- 2 cm	530 g/m ²
		Reflect	63100900	100% recycled polyester	142 cm +/- 2 cm	310 g/m ²
F6o	1570.00	Hopsak	62300500	100% polyamide	127 cm +/- 2 cm	550 g/m ²
		Olimpo	62401400	70% linen, 30% rayon	146 cm +/- 3 cm	520 g/m ²
		Twill	62403300	30% polyamide, 70% new wool	155 cm +/- 2 cm	325 g/m ²
		Volo	62404700	15% polyamide, 85% new wool	145 cm +/- 3 cm	435 g/m ²
F8o	1910.00	Corsaro	62403900	5% polyamide, 10% cotton, 46% polyacrylics, 5% linen, 20% wool, 14% polyester	140 cm +/- 2 cm	450 g/m ²
		Cosy 2	62407600	20% polyamide, 80% new wool	154 cm +/- 2 cm	590 g/m ²
		Dumet	62403600	9% polyamide, 46% cotton, 8% linen, 22% wool, 15% rayon	147 cm +/- 2 cm	485 g/m ²
		Iroko 2	62406300	32% cotton, 48% polyacrylics, 20% polyester	152 cm +/- 3 cm	700 g/m ²
		Linho	62407000	9% polyamide, 91% linen	137 cm +/- 2 cm	450 g/m ²
		Savana	63100400	8% polyamide, 19% cotton, 50% polyacrylics, 23% linen	140 cm	820 g/m ²
		Tress	62407300	8% polyamide, 73% new wool, 19% polyester	142 cm +/- 2 cm	310 g/m ²
F1oo	2280.00	Aura	62405900	3% polyamide, 97% new wool	144 cm +/- 2 cm	390 g/m ²
		Nubia	63100300	2% polyamide, 30% new wool, 25% polyacrylics, 43% polyester	140 cm	570 g/m ²
		Reed	62407200	7% polyamide, 48% cotton, 25% new wool, 20% linen	142 cm +/- 2 cm	400 g/m ²
		Tonus	62309800	90% new wool, 10% helanca	140 cm	490 g/m ²
F12o	2660.00	Credo	62401300	5% polyamide, 95% new wool	145 cm +/- 2 cm	640 g/m ²
		Track	62408100	10% polyamide, 90% new wool	143 cm +/- 2 cm	480 g/m ²
F2oo	3970.00	Checker	62406201	77% cotton, 23% polyester	140 cm	467 g/m ²



Overview of cover materials

Leathers with a price group

Leather exclusively available in half (ca. 2.7 m²) or full hides (ca. 5-6 m²).

Price group	without VAT in SEK / m ²		Article no.	Material	Thickness
L10	-	Leather Liso	*	Split leather	1.8-2.0 mm
L20	-	Leather Forte (deco)	*	Split leather with decorative finish	1.8-2.0 mm
	2400.00	Leather	62300100	Robust cowhide with a distinctive, even grain	1.1-1.3 mm
L50	3480.00	Leather Premium F	63100500	Semi-aniline nappa leather with a very soft and supple feel, vegetable tanned	1.1-1.3 mm
L60	5060.00	Leather Natural F	62401700	Aniline nappa leather with a natural open-pore grain, vegetable tanned	1.1-1.3 mm

* The material cannot be ordered from Vitra in linear metres/hides.

Overview of cover materials

Textiles with no price group

Fabric orders in full metres only.

without VAT in SEK / lin. m		Article no.	Material	Width	Weight
-	Coda	*	10% nylon, 90% new wool	140 cm	860 g/m ²
110.00	Diamond Mesh	62401900	100% polyester	165 cm	600 g/m ²
-	Drop	*	20% nylon, 60% new wool, 20% polyester	157 cm +/- 2 cm	520 g/m ²
1930.00	FleeceNet	62404900	46% polyamide, 1% spandex, 53% polyester	135 cm +/- 2 cm	430 g/m ²
-	Intreccio	*	23% cotton, 77% new wool	140 cm	780 g/m ²
1570.00	Netweave Aluminium Chair	62301000	71% polyurethane, 29% polyester	138 cm +/- 2 cm	630 g/m ²
-	Planum	*	14% nylon, 44% new wool, 42% polyester	162 cm +/- 2 cm	400 g/m ²
110.00	Silk Mesh nero	62402000	33% polyamide, 67% polyester	170 cm +/- 3 cm	300 g/m ²
	Silk Mesh colours		100% polyester		
-	Simmons	*	83% polypropylene, 17% polyester	140 cm	330 g/m ²
-	Duo Knit	**	4% spandex, 96% polyester		540 g/m ² +/- 10%
-	Netline	**	100% polyester		360 g/m ²
-	SingleKnit	**	5% spandex, 95% polyester		475 g/m ²
-	Striped Knit	**	4% spandex, 96% polyester		540 g/m ² +/- 10%
-	Tricot Slow Chair	**	100% polyester		607 g/m ²
-	TrioKnit	**	4% spandex, 96% polyester		607 g/m ²

* The material cannot be ordered from Vitra in linear metres/hides.

** The covers are knit-to-fit and not available by the metre.



Office task chair, using the example of ID Soft

Dimensions measured in accordance with EN 1335-1:2000

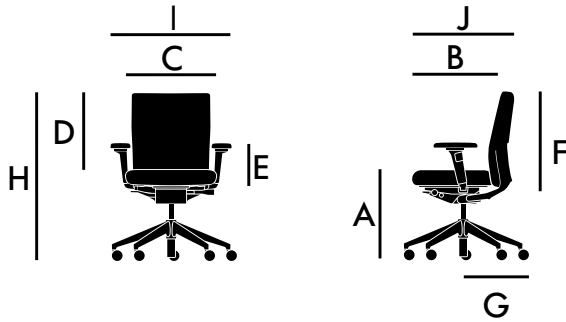
**A Seat height**

(measured at central vertical axis with applied weight load of 64 kg)

B Seat depth

(distance from front edge of seat to foremost point of the lumbar zone)

C Seat width

(measured horizontally to central vertical axis)

D Height of top edge of backrest from seat surface

(measured at central vertical axis with applied weight load of 64 kg)

E Height of armrest from seat surface

(measured at central vertical axis with applied weight load of 64 kg)

F Height of backrest section**G Maximum base radius**

(including castors/glides)

H Height**I Width of upper part****J Depth of upper part**

Visitor chair, using the example of the Softshell Chair

Dimensions measured in accordance with EN 1335-1:2000

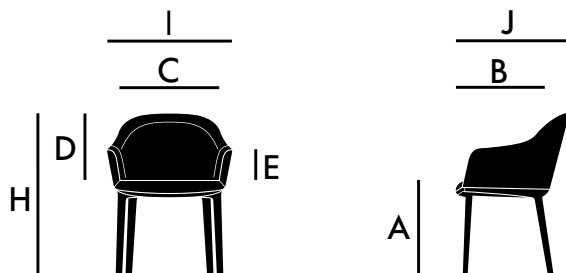
**A Seat height**

(measured in back third of seat surface with applied weight load of 64 kg)

B Seat depth

(distance from front edge of seat to foremost point of the lumbar zone)

C Seat width

(measured in back third of seat surface with applied weight load of 64 kg)

D Height of top edge of backrest from seat surface

(measured at central vertical axis with applied weight load of 64 kg)

E Height of armrest from seat surface

(measured from back third of seat surface with applied weight load of 64 kg)

H Height**I Width****J Depth**

Lounge chairs and armchairs, using the example of the Eames Lounge Chair

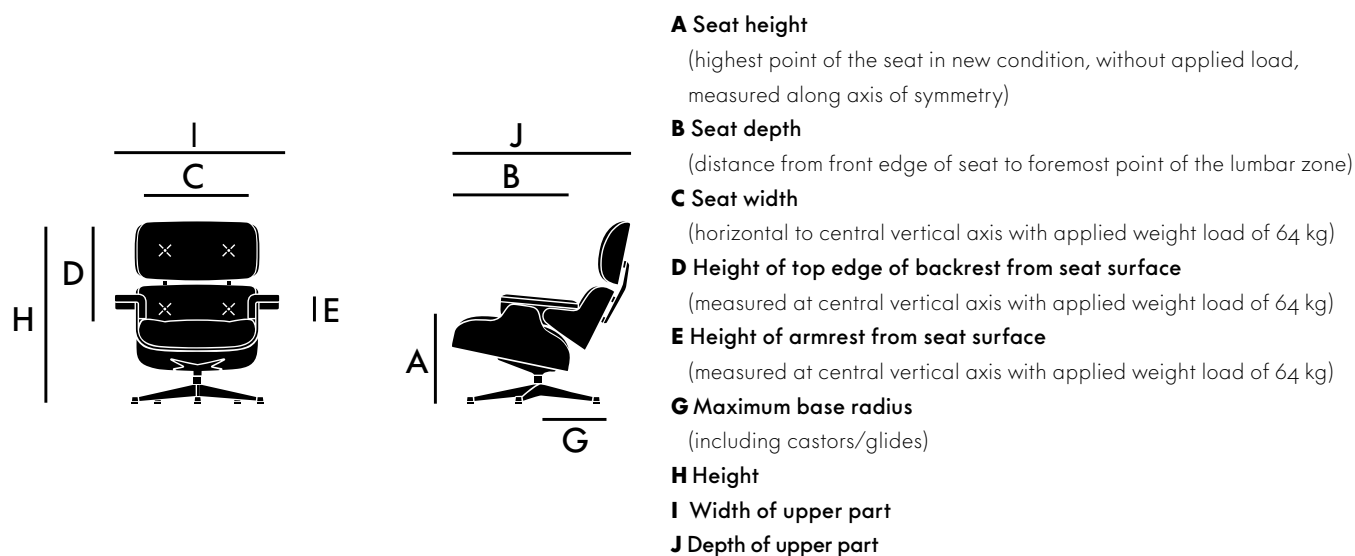

With upholstered furniture, dimensions can vary by up to approximately 30 mm due to varying firmness and a tolerance range for the convex profiles of foam padding.

If the seat height measured in accordance with EN 1335-1:2000 is listed, it has been measured in the rear third of the seat surface under a weight load of 64 kg.

Sofas, using the example of the Suita Sofa

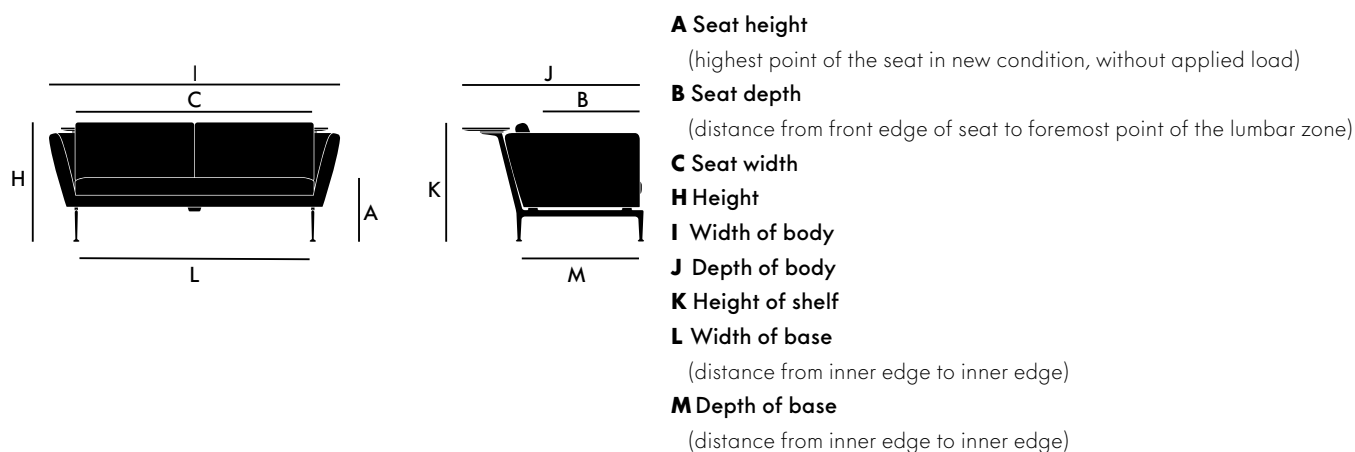

With upholstered furniture, dimensions can vary by up to approximately 30 mm due to varying firmness and a tolerance range for the convex profiles of foam padding.

If the seat height measured in accordance with EN 1335-1:2000 is listed, it has been measured in the rear third of the seat surface under a weight load of 64 kg.



Distribution rights

Price list

All of the designs shown in this publication as well as the images themselves are legally protected. Vitra and the Vitra Design Museum have been authorised by the authors or their legal successors to exclusively manufacture, develop and distribute the products corresponding to these designs worldwide.

The following restrictions apply:

Charles & Ray Eames → Organic Chair, La Chaise, Eames Elephant, Plywood Mobile, Classic Trays, Paper Napkins, Eames Quotes Posters, Eames Wool Blankets and Miniatures Collection: Vitra holds the worldwide rights.

All other products: Vitra holds the rights in Europe and the Middle East.

The rights in the rest of the world are held by MillerKnoll.

Alexander Girard → Environmental Wall Hangings and Flower Table: Vitra holds the rights in Europe and the Middle East.

The rights in the rest of the world are held by MillerKnoll.

George Nelson → Clocks and Miniatures Collection: Vitra holds the worldwide rights.

All other products: Vitra holds the rights in Europe and the Middle East.

The rights in the rest of the world are held by MillerKnoll.

Isamu Noguchi → Akari Light Sculptures: Vitra holds the distribution rights in Europe and the Middle East as well as in Australia and New Zealand.

The rights for North America are held by the Isamu Noguchi Foundation and Garden Museum and for Japan by Ozeki & Co..

Coffee Table and Dining Table: Vitra holds the worldwide rights with the exception of North America.

The rights in North America are held by MillerKnoll.

Sori Yanagi → Butterfly Stool: Vitra holds the rights in Europe, Africa and North and South America.

The rights in the rest of the world are held by Tendo Mokko.



The design of the Eames Aluminium Chair is a registered trademark.



The design of the Eames Lounge Chair is a registered trademark.



The design of the Panton Chair is a registered trademark.

ALEXANDER GIRARD, EAMES, NELSON, GEORGE NELSON, NOGUCHI, ISAMU NOGUCHI, PANTON, VERNER PANTON, PROUVE and JEAN PROUVE are registered trademarks.

Various product names enjoy trademark protection.

vitra.

© All copyrights and intellectual property rights, including trademarks, patents and copyrights, remain the property of Vitra and are explicitly reserved.

No part of this brochure may be reproduced without prior written permission from Vitra.

General Terms and Conditions of Sale (Sweden) of Vitra International AG, Birsfelden, Switzerland

The following terms and conditions apply to all sales and deliveries of Vitra International AG ("Vitra" or "we") in the territory of Sweden unless otherwise agreed in writing. Any terms or other conditions contained in any purchase order or other form used by customer to order products that are different from, in addition to, or in any way inconsistent with Vitra's General Terms and Conditions of Sale are rejected and shall be of no force or effect.

1. Offers and conclusion of contract

Our offers and quotations are non-binding and subject to change. A binding contract is only concluded upon receipt of Vitra's written order confirmation. Orders confirmed by Vitra ("Confirmed Orders") are binding.

Illustrations and descriptions in our price lists, catalogues and any other documentations as well as any samples submitted are not binding for the execution of the goods. Changes in construction, variations in wood grains and minor deviations in design or colour shading are reserved.

2. Delivery terms

Deliveries are made DAP (Incoterms 2020) to the customer's delivery site in Sweden and are exclusive of installation, unless otherwise noted in any Confirmed Order. Partial deliveries may be made. Each partial delivery may be invoiced separately. Dispatch and choice of freight carrier are at Vitra's discretion.

Indications on delivery dates and times are approximate, unless we have specifically declared them to be binding in writing. Any modifications requested by the customer extend the indicated delivery times. When orders are made on call, the call must be made at least four weeks prior to the requested delivery date.

In the event that the customer is in default of acceptance, the goods will be stored at the customer's expense, with monthly storage charges amounting to at least 1% of the invoice value.

3. Transfer of risk

All risks of loss and damage shall pass to the customer at the time Vitra places the goods in the possession of a freight carrier or any other third party responsible for the delivery. Transport insurance is only taken out at the customer's request and expense.

4. Prices

Unless otherwise noted, prices are stated in SEK and exclusive of any VAT, customs duties and other public charges.

Prices are inclusive of dust-protective wrapping or any other standard packaging as determined by Vitra. Non-standard packaging materials are invoiced to the customer at cost.

Should the factors underlying the price formation (raw materials, transportation costs, collectively agreed wages, customs duties) increase prior to the delivery of the goods, Vitra shall be entitled to charge the customer the corresponding price increase in addition to the Confirmed Order price.

5. Payments

Invoices are payable within 30 days (net) from the invoice date, unless otherwise agreed. Payment is considered received as soon as and to the extent it has been credited to our bank account.

Vitra is, at its sole discretion, entitled to request a partial or full prepayment at any time. Should payment be delayed, interest in arrears at a rate of 5% shall be automatically charged to the customer. In the event that customer's payment is delayed for more than seven (7) calendar days, or if there are justified doubts as to the customer's solvency, we are entitled to (i) revoke all credit, (ii) reject any further orders of the customer and (iii) withdraw from or suspend any as yet unfulfilled part of purchase contracts already concluded with the customer, in each case without incurring any liability to the customer.

The customer may only set off counterclaims against our claims if customer's counterclaims are uncontested or established as final by a competent court of law. In particular, the customer is not permitted to withhold payment or make deductions to invoiced amounts in the event of complaints relating to the goods.

6. Retention of title

Title to and ownership of goods supplied by us shall remain vested in Vitra and shall not pass to the customer until the purchase price has been paid by the customer in full. Customer shall be obliged to store relevant goods in such a way as to enable them to be identified as our property and is prohibited from pledging or using the retained goods as a security without our written consent. Until title to the goods passes, upon our request, customer must facilitate our repossession of the goods and we or our agents shall be entitled at any time to enter the property in which the relevant goods are stored. In case of repossession, we may claim rent and damages for potential use of the goods, plus legal costs and transportation costs. Further claims for improper use of the goods remain reserved. Irrespective of whether title to the goods remains vested in Vitra, risk shall pass to the customer in accordance with Sec. 4.

As a precautionary measure, the customer assigns to Vitra in advance all rights arising out of the potential further sale of goods to which we retained title in accordance with the foregoing. Upon our request, the customer must inform the purchasers of relevant goods about the assignment of rights and hand over the necessary documentation to us.

As long as the customer meets his commitments towards Vitra, the customer may dispose of the unpaid goods according to normal business practice and collect the assigned receivables.



7. Warranty and defects

Vitra warrants that the goods are free from defects in material and workmanship for two years from the date of delivery. All other warranties are expressly excluded.

Vitra's warranty does not apply to defects, damage, failure or loss resulting from (i) improper use or incorrect handling or modification of the goods (e.g. treatment of fabrics with unsuitable chemical agents), (ii) non-compliance with the instructions for use or exposure to unsuitable environmental conditions (climate, humidity, chemicals, direct sunlight), (iii) maintenance by unauthorized persons, (iv) normal wear and tear (e.g. regarding castors, surfaces) and (v) the use of customer owned materials (COM). Vitra is not responsible for damage to goods which occurs in transit. Damages in transit shall be notified to the responsible carrier in writing immediately after receipt of the goods and Vitra shall be informed accordingly.

Defects in the goods supplied, discrepancies in quantities supplied or incorrect delivery must be notified to Vitra within eight (8) calendar days from receipt of the goods. In case of hidden defects, the customer shall notify Vitra within five (5) calendar days after having detected such defect. Otherwise, the customer shall lose its claims with regard to these defects.

The customer has to check the delivered goods immediately upon receipt. If any goods prove to be defective, we will, at our own discretion, either rectify the defect or deliver a comparable replacement product (or replacement product part). If repair or replacement is commercially impracticable, we may grant to the customer a refund or price reduction for the defective goods. There shall be no other right of claim against us. Delivery of a replacement product does not result in a renewal or extension of the warranty period.

Vitra's liability is strictly limited to the aforementioned obligations. Vitra shall bear no liability for any indirect or consequential loss, loss of profits or loss of business of customer howsoever arising. No limitation applies to Vitra's liability for death or personal injury, damages caused by Vitra's willful misconduct or gross negligence or in case of mandatory product liability.

8. Force majeure

We shall not be responsible or liable for any failure or delay in the performance of our obligations caused by, directly or indirectly, forces beyond our control or the control of our suppliers, including, without limitation, strikes, breakdowns, work stoppages, accidents, acts of war or terrorism, civil or military disturbances, catastrophes and interruptions, epidemics and pandemics (including Covid-19), loss or malfunctions of utilities, communications or computer (software and hardware) services.

9. Data protection

We only capture, process or use personal data in accordance with applicable data protection law provisions. Details are set out in our Privacy Policy, which can be accessed at <https://www.vitra.com/cpt> or requested from us at any time.

10. Governing law and jurisdiction

The legal relationship between Vitra and the customer shall be governed by Swiss law, excluding the UN Convention on Contracts for the International Sale of Goods (CISG). The place of jurisdiction shall be Muttenz, Switzerland. However, we shall be entitled to sue the customer at his residence or seat of company.

11. Severability

In case any provision in these General Terms and Conditions of Sale shall be invalid or unenforceable, the validity and enforceability of the remaining provisions shall not in any way be affected or impaired thereby and such provision shall be ineffective only to the extent of such invalidity or unenforceability.

Version: 1 January 2023

Vitra International AG
Klünfeldstrasse 22
CH-4127 Birsfelden

Tel +41 61 377 00 00
Fax +41 61 377 15 10
info@vitra.com
www.vitra.com





vitra.

Color & Material Library
2023

english



Colour & Material Library

vitra.

The Vitra Colour & Material Library comprises a variety of textiles and leathers, but also features solid materials, including the colours and textures of plastics, metals, woods and other materials. Together, these form a system offering countless possible combinations with a coherence that make it easy for architects, interior designers or private clients to define a lively interior collage with a strong identity.

'The Vitra Colour & Material Library encourages creative freedom and fires the imagination – not by making everything possible, but by providing a clear display of options.'
Hella Jongerius.



Hella Jongerius

The Dutch designer Hella Jongerius lives and works in Berlin. She founded the Jongeriuslab studio in 1993. For Vitra, the Dutch designer has developed distinctive pieces such as the Polder Sofa and the East River Chair. Jongerius has consistently addressed the significance of colours and surfaces in contemporary design in her work with textiles, ceramics and furniture. She has been the Art Director for colours and materials at Vitra for

many years and developed the Vitra Colour & Material Library – a system that enables the versatile combination of different materials and colours throughout the extensive Vitra product collection.



© Studio Likeness

Colour Worlds

The aim of this collaboration is to create a unique realm of Vitra colours and materials that augment contemporary designs and renew classic pieces in the collection. Her colour concept for Vitra organises all colours in four contrasting colour worlds. The greens, the reds, the lights and the darks suit both home and office. The system encompasses the entire spectrum of colours,

while the different colour worlds classify their specific purpose. The Vitra Colour and Material Library is no advice kit. It is to be used as a tool, both within the design and production process as well as outside of the company grounds.

GREENS

After living in a green environment for thousands of years, distinguishing prey or edible plants, our eyes' colour receptors have become most sensitive to the greens. A biological evolutionary process now enables us to differentiate many shades.



DARKS

Retreating and absorbing, the darks are more distant and calm. They take in light and hold warmth. They are shadow colours – the darker a colour, the further it seems to be away from its observer.



LIGHTS

The light colours, which we call 'lights', accentuate, reflect and project other colours. They remind us of an empty sheet of paper, untouched snow and are a Western symbol of purity.



REDS

Red hues appear vibrant, dynamic and more immediate than other colours. Along with oranges and yellows, they need light to unfold their true beauty. Red is the first colour that babies acknowledge.



Bridge Colour Palettes

Bridge colours in the Vitra Colour and Material Library offer a link between various contrasting objects and materials. Every bridge colour appears in several materials and textiles and results in a corresponding palette – a range of hues based on one single tone that vary slightly in appearance, depending on the material's characteristics. Every new colour is designed to accentuate the respective material's texture and surface qualities. Because whether a surface is glossy, translucent or rough, and how the surfaces react to shadow play and reflections, determines the colour's hue within a bridge colour palette.

The brick colour looks darker on a matt plastic than in an Aura fabric because the textile's construction is based on a cluster of yarns and binding that exhibit a satiny complexion. The customer can choose from a range of colour options and materials within each bridge colour palette to create a link between various pieces of furniture for tone-on-tone settings.

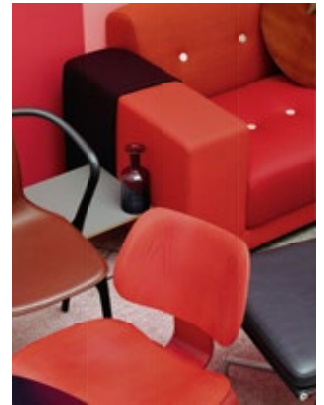
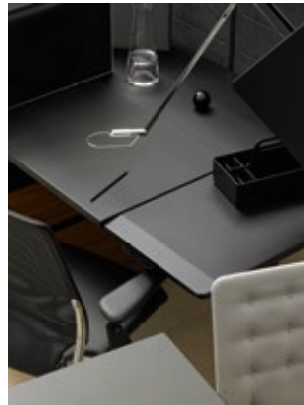
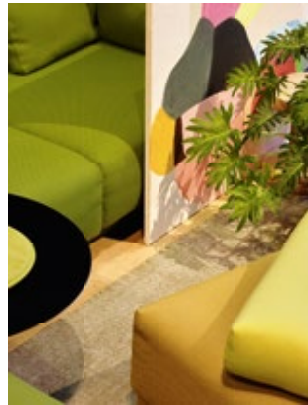

cognac



avocado



mustard



basic dark



brick



poppy red



blue



coffee



warm grey



ice grey



classic red



chocolate



cream



light grey

Duotones

A duotone weave, just like an impressionist painting, can demonstrate how the perception of colours is an activity. Participation is necessary in order to actually see the colour emerge from the thick and loose yarns or brushstrokes. The world of industrial production tends to exclude such activity, as it excludes instability. Yet it is precisely this instability that brings colours to life and makes us gaze at them.

The duotone concept sets up a colour conversation between the warp and the weft. The warp is typically in a darker colour than the weft yarn, which gives an optical depth to the weave. The interweaving of two different colours unites the realm of office spaces with the softness and intimacy of home. A colour composed of layers keeps a colour fascinating. You have to blink twice. Is that surface red? Or is it grey? It does not look the same in the morning as it does in the evening or in winter and summer.

Hopsak



88
cognac/ivory

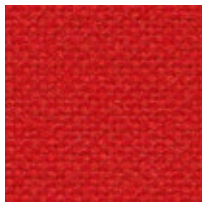

63
red/poppy red

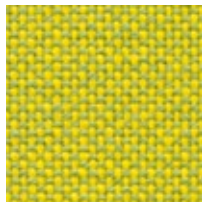

71
yellow/pastel green

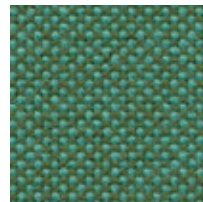

86
mint/forest

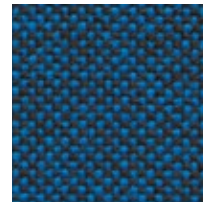

84
blue/moor brown



82
ice blue/moor brown



Designer Libraries

Within the Vitra Colour & Material Library each designer developed it's own colour palette based on his own aesthetics, the design approach and the furniture shape. The library guarantees that almost all colours, surfaces and textiles are easy to combine or offers matching colour partners – even across the different Designers libraries. In addition the so called signature colours make the individual palettes unique for each designer. Signature colours are shades that can only be used by one designer. They are sometimes even limited to one product only. Usually, design-

ers themselves will suggest a signature colour because they like that specific shade or have a particular role in mind for this colour. When re-introducing classic designs, a decision will be made in close cooperation with Hella Jongerius and the respective designer's family or heirs.



Konstantin Grcic Antonio Citterio Jay Osgerby Alberto Meda Jasper Morrison Erwan Bouroullec & Ronan Bouroullec Edward Barber Hella Jongerius



Erwan & Ronan Bouroullec



Hella Jongerius



Jasper Morrison

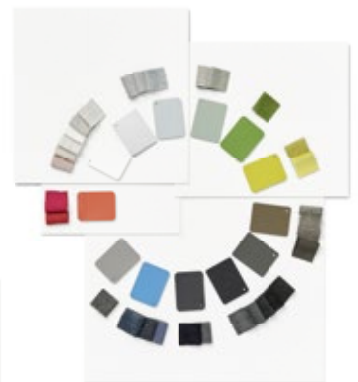

Jay Osgerby & Edward Barber

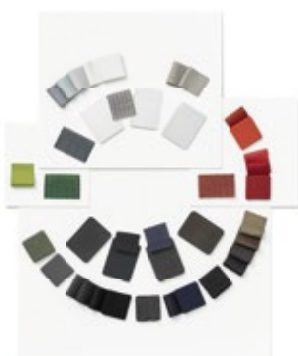

Alberto Meda



Charles Eames



Jean Prouvé



Konstantin Grcic

Textiles

8	Aura	21	LightNet	34	Silk Mesh
9	Checker	22	Linho	35	Simmons
10	Corsaro	23	Mello	36	SingleKnit
11	Cosy 2	24	Netline	37	Striped Knit
12	Credo	25	Netweave Aluminium Chair	38	Tonus
13	Diamond Mesh	26	Nova	39	Track
14	Drop	27	Nubia	40	Tress
15	Dumet	28	Olimpo	41	TrioKnit
16	Duo Knit	29	Plano	42	Twill
17	FleeceNet	30	Planum	43	Volo
18	Hopsak	31	Reed	44	Overview of cover materials
19	Iroko 2	32	Reflect		
20	Laser RE	33	Savana	46	Kvadrat Selection

Leather

50	Leather
53	Leather Premium F
56	Leather Natural F
57	Leather Forte (deco)
58	Leather Liso
59	Overview of Leather

Surfaces

60	Plastic	79	HPL
64	Recycled plastic	80	Solid core HPL
65	Fibreglass	81	Linoleum
66	Polyurethane	81	Bonded leather
67	Metal	82	Marble
73	Solid Wood	82	Glass
75	Veneer	83	Cork
77	MDF	83	Corrugated Cardboard
78	Melamine	84	Fleece

Product-specific combinations

85	East River Chair
86	Polder
87	Slow Chair & Ottoman

Aura

Home, F100

vitra.



The woollen textile Aura has a classic satin (atlas) weave with a fine, soft surface. This fabric is distinguished by a supremely soft feel, lustrous sheen and smooth even surface. The solid and mixed colours feature dynamic, highly saturated tones made possible by wool's excellent dyeability.

Aura is available in 26 colours.

Material	3% polyamide, 97% new wool
Weight	390 g/m ² (11.5 oz/y ²)
Width	144 cm +/- 2 cm (56")
Abrasion resistance	20,000 Martindale
Fastness to light	Type 5
Pilling	Grade 3-4
Fastness to rubbing	Grade 3-4 dry and wet

Citizen (neck cushion)
Mariposa Club Armchair
Mariposa Sofa
Soft Modular Sofa
Softshell Chair

Aura

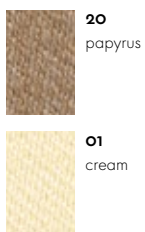

Checker

Home, F200

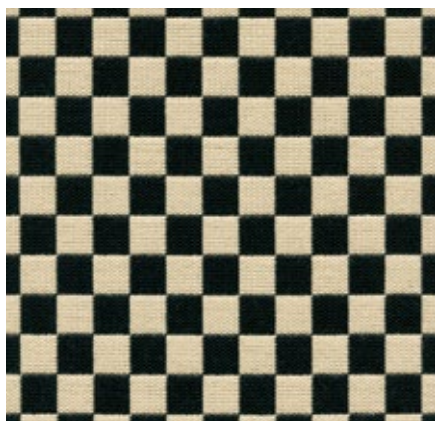

Alexander Girard developed the textile pattern 'Checker' in 1965 as part of his legendary redesign of the corporate image for Braniff International Airlines. The checkerboard design is a prime illustration of Girard's radical break from the conventional low-key aesthetic that characterised the sector at that time. The soft double weave fabric, with a high percentage of cotton, demonstrates exceptional purity of colour and its geometric pattern lends a striking note to any environment.

Material	77% cotton, 23% polyester
Weight	467 g/m ² (13.8 oz/y ²)
Abrasion resistance	20,000 Martindale
Fastness to light	Type 6
Pilling	Grade 4-5
Fastness to rubbing	Grade 4-5 dry and wet

Eames Plastic Chairs
Wire Chair

Checker



01
black/white

Corsaro

Home, F8o

vitra.



Corsaro is a sophisticated combination of fine and coarse yarns that give the fabric a natural look with a Mediterranean flair.

The two-tone and three-tone shades interwoven with several novelty yarns add particular vibrancy to large surface areas.

Corsaro is available in 13 colours.

Material	5% polyamide, 10% cotton, 46% polyacrylics, 5% linen, 20% wool, 14% polyester
Weight	450 g/m ² (13.3 oz/y ²)
Width	140 cm +/- 2 cm (55'')
Abrasion resistance	35,000 Martindale
Fastness to light	Type 5
Pilling	Grade 3-4
Fastness to rubbing	Grade 3-4 dry and wet

Grand Relax
Grand Sofà
Mariposa Club Armchair
Mariposa Sofa

Soft Seats
Suita Club Armchair
Suita

Corsaro



01
pale blue
melange



11
steel blue
melange

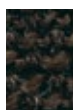

02
dark brown
melange



08
sierra
melange



04
dark blue
melange



07
canola
melange



10
pepper
melange



03
dark grey
melange



09
bamboo
melange



12
graphite
melange



13
black
melange



05
stone
melange



06
sand
melange

Cosy 2

Home/Office, F80

vitra.



Cosy 2 is a high-quality milled woollen cloth with a warm character. The lively melange yarn emphasises the fabric's natural colours – from delicate shades to vibrant hues – and gains added elegance with colour-coordinated stitching. The fabric offers thermal comfort and excellent durability, making it suited for upholstered furniture in office settings as well as residential applications.

Cosy 2 is available in 15 colours.

Material	20% polyamide, 80% new wool
Weight	590 g/m ² (17.4 oz/y ²)
Width	154 cm +/- 2 cm (60")
Abrasion resistance	50,000 Martindale
Fastness to light	Type 6
Pilling	Grade 4-5
Fastness to rubbing	Grade 4-5 dry and wet

Alcove
Alcove Plus
Citizen

Grand Relax
Grand Sofà
HAL Lounge Chair

Organic Chair
Soft Modular Sofa
Soft Seats

Cosy 2

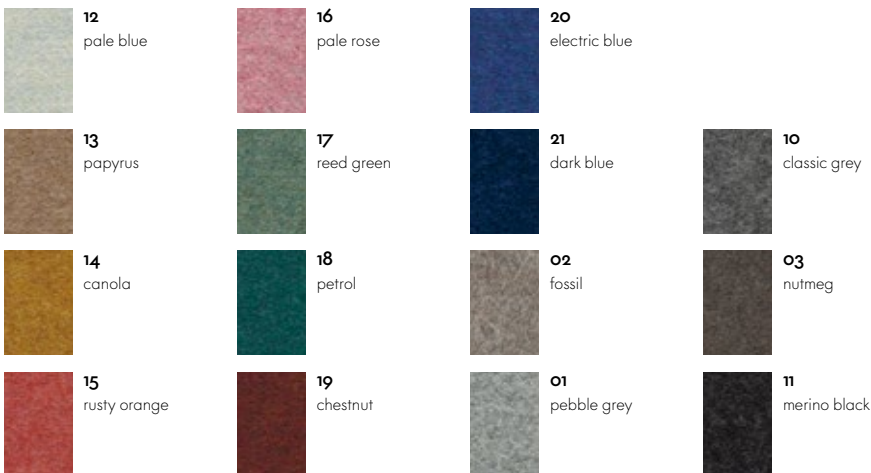

Petit Repos
Repos & Grand Repos

Suita Club Armchair
Suita

Cosy 2 (cross stitch)



Credo

Home/Office, F120

vitra.

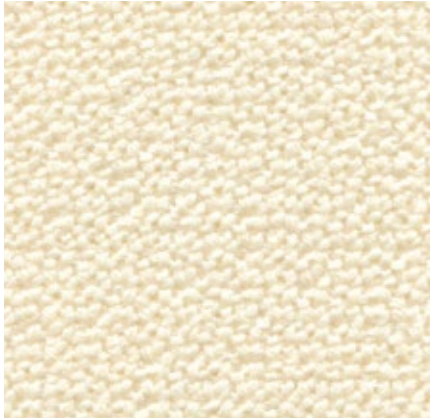

Credo is a durable woollen fabric made of premium worsted yarn with a pleasant feel. The two- and three-tone colours give this fabric a characteristic structure and vibrant appearance. Credo allows for an effective exchange of heat to ensure comfortable thermal conditions for the sitter. The fabric can also be used in office environments.

Credo is available in 22 colours.

Material	5% polyamide, 95% new wool
Weight	640 g/m ² (18.9 oz/y ²)
Width	145 cm +/- 2 cm (57")
Abrasion resistance	100,000 Martindale
Fastness to light	Type 6
Pilling	Grade 4-5
Fastness to rubbing	Grade 4-5 dry and wet

Alcove
Alcove Plus
Citizen
Freeform Sofa
Grand Sofà
HAL Lounge Chair

HAL Soft
Mariposa Club Armchair
Mariposa Sofa
Organic Chair
Petit Repos
Repos & Grand Repos

Soft Modular Sofa
Soft Seats
Suita
Suita Club Armchair
Suita Club Sofa

Credo

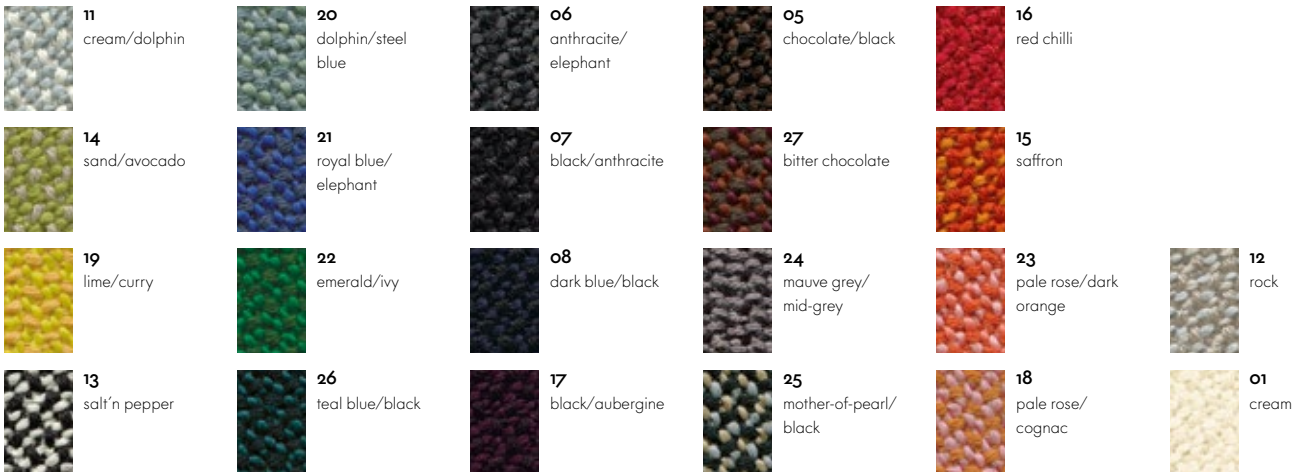

Diamond Mesh

Home/Office

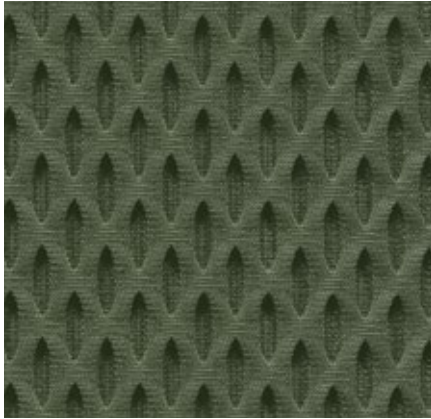

Diamond Mesh is a technical spacer fabric with a three-dimensional honeycomb structure. The hollow cells in the hexagonal structure facilitate air circulation and ensure comfortable thermal conditions. These characteristics, combined with the technical, yet vibrant look of this robust knit, make it an excellent choice for office settings.

Diamond Mesh is available in 7 colours.

Material	100% polyester
Weight	600 g/m ² (17.7 oz/y ²)
Width	165 cm (64")
Abrasion resistance	45,000 Martindale
Fastness to light	Type 6
Pilling	Grade 4-5
Fastness to rubbing	Grade 4-5 dry and wet

ID Mesh
ID Visitor Mesh
Unix Chair

Diamond Mesh



24
soft grey



21
dim grey



77
brick



67
asphalt



01
olive green



66
nero



02
smoke blue

Drop

Home/Office

vitra.



Drop is a knitted upholstery fabric with a lively three-dimensional look. Designed with colour compositions of up to three different hues, Drop exhibits a pattern reminiscent of a string of coloured pearls in an interplay of light and shadow. The robust knit fabric is suited for home settings, as well as public spaces.

Drop is available in 10 colours.

Material	20% nylon, 60% new wool, 20% polyester
Weight	520 g/m ² (15.3 oz/y ²)
Width	157 cm +/- 2 cm (61")
Abrasion resistance	80,000 Martindale
Fastness to light	Type 6
Pilling	Grade 4-5
Fastness to rubbing	Grade 4-5 dry and wet

Abalon

Drop



09
beige/cream
(101)



02
dark green/
ochre (951)



06
light grey/cream
(121)



01
dark green/
green (961)



08
mauve/beige
(221)



03
dark green/grey
(971)



04
dark red/red
(691)



07
dark grey/
mauve (261)



05
dark red/mauve
(671)



10
black/dark grey
(191)

Dumet

Home, F8o



Dumet is a cotton blend in a plain weave with a lively appearance. The natural mixed tones create an elegant look with an Italian flair. Dumet is soft and cool to the touch.

Dumet is available in 20 colours.

Material	9% polyamide, 46% cotton, 8% linen, 22% wool, 15% rayon
Weight	485 g/m ² (14.3 oz/y ²)
Width	147 cm +/- 2 cm (57")
Abrasion resistance	40,000 Martindale
Fastness to light	Type 5
Pilling	Grade 3-4
Fastness to rubbing	Grade 3-4 dry and wet

Grand Relax
Grand Sofà
HAL Lounge Chair
HAL Soft
Mariposa Club Armchair

Mariposa Sofa
Petit Repos
Repos & Grand Repos
Soft Modular Sofa
Soft Seats

Softshell Chair
Suita Club Armchair
Suita

Dumet

 30 blackberry melange	 06 pebble melange	 11 yellow melange	 10 pale rose/beige	 07 ginger/grey
 31 Dumet - indigo melange	 27 pale blue/emerald	 24 mango melange	 23 pale rose/coral	 03 beige/grey
 33 carbon/black	 28 Dumet - sage/steel blue	 25 ochre melange	 29 dark red melange	 02 beige melange
 32 sierra grey melange	 26 pale blue/chartreuse	 22 pale blue/pale rose	 17 sand melange	 01 ivory melange

Duo Knit

Home/Office



Duo Knit is an elastic form-fitted knit fabric designed especially for the ID Cloud backrest. The lightly textured surface gives it an inviting high-quality appearance.

Duo Knit is available in 7 colours.

Material	4% spandex, 96% polyester
Weight	540 g/m ² +/- 10%
Abrasion resistance	40,000 Martindale
Fastness to light	Type 6
Pilling	Grade 4-5
Fastness to rubbing	Grade 4-5 dry and wet

ID Cloud

Duo Knit

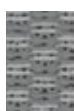

01
cream white/
sierra grey



05
ink blue/
turquoise



03
petrol/
nero



06
brick/
orange



02
dark grey/
nero



04
dark red/
nero



07
nero

FleeceNet

Home/Office

vitra.

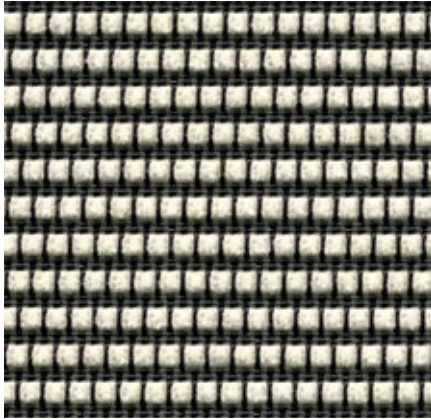

FleeceNet is a technical netweave made of polyester and polyamide with an interwoven chenille yarn. FleeceNet does not have a closed surface, making it breathable and promoting comfortable thermal conditions. The interweaving of different yarns allows for a variety of new colour combinations.

FleeceNet is available in 4 colours.

Material	46% polyamide, 1% spandex, 53% polyester
Weight	430 g/m ² (12.7 oz/y ²)
Width	135 cm +/- 2 cm (53")
Abrasion resistance	100,000 Martindale
Fastness to light	Type 6
Pilling	Grade 4-5
Fastness to rubbing	Grade 4-5 dry and wet

Physix

FleeceNet



07
soft grey



03
ice grey



08
mid-grey

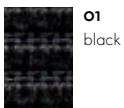

01
black

Hopsak

Home/Office, F60

vitra.

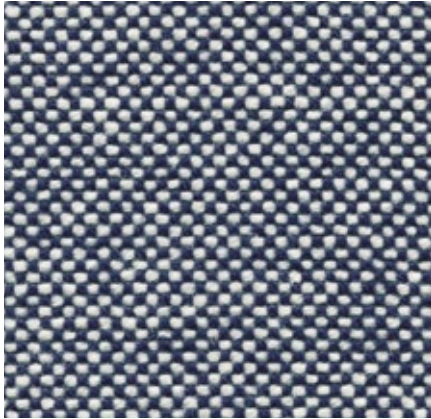

Hopsak is an expressive, flat plain-weave fabric made of polyamide. The duotone colours offer a multitude of design possibilities in high-contrast, brightly hued or subtle combinations of warp and weft threads. Highly durable and robust, Hopsak can be used in private interiors as well as public areas.

Hopsak is available in 35 colours.

Material	100% polyamide
Weight	550 g/m ² (16.2 oz/y ²)
Width	127 cm +/- 2 cm (50")
Abrasion resistance	200,000 Martindale
Fastness to light	Type 6
Pilling	Grade 4-5
Fastness to rubbing	Grade 4-5 dry and wet

AC 5 Group
Allstar
Coconut Chair
Eames Aluminium Group
Eames Plastic Chairs

HAL
HAL Armchair
Organic Chair
Soft Seats
Visiona Stool

Wire Chair

Hopsak

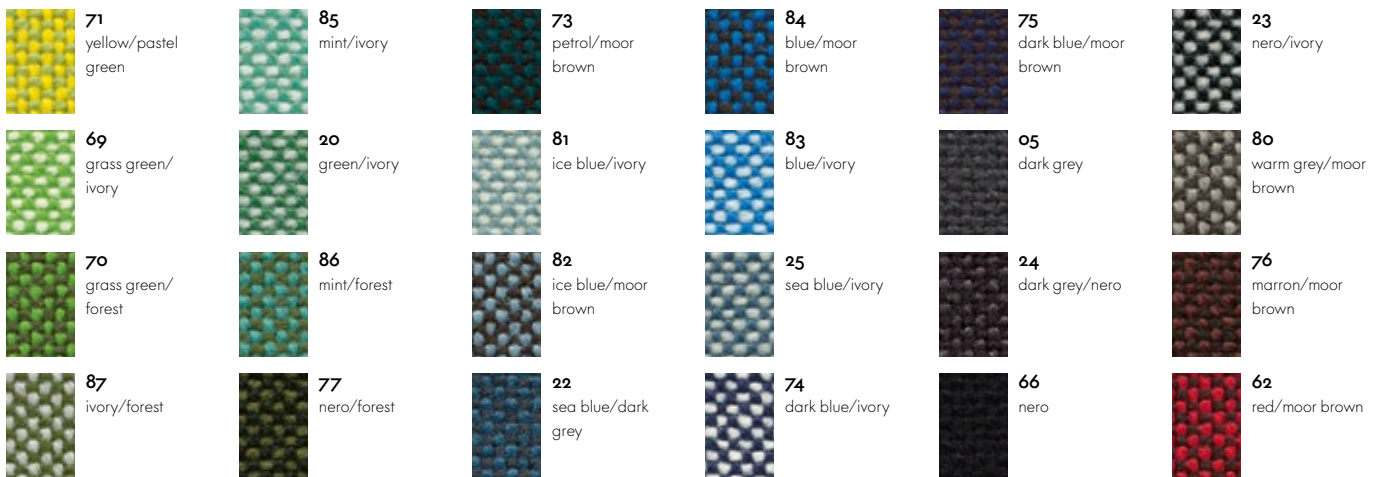

Iroko 2

Home, F80



Iroko 2 is a soft, flat woven fabric made with chenille yarn. The piles in the yarn give the weave a lively surface texture with an inviting, velvety touch. The fabric's cotton fibres provide excellent cooling properties.

Iroko 2 is available in 17 colours.

Material	32% cotton, 48% polyacrylics, 20% polyester
Weight	700 g/m ² (20.6 oz/y ²)
Width	152 cm +/- 3 cm (60")
Abrasion resistance	40,000 Martindale
Fastness to light	Type 5
Pilling	Grade 3-4
Fastness to rubbing	Grade 3-4 dry and wet

Grand Sofà
Mariposa Club Armchair
Mariposa Sofa
Soft Modular Sofa
Soft Seats

Suita Club Armchair
Suita

Iroko 2

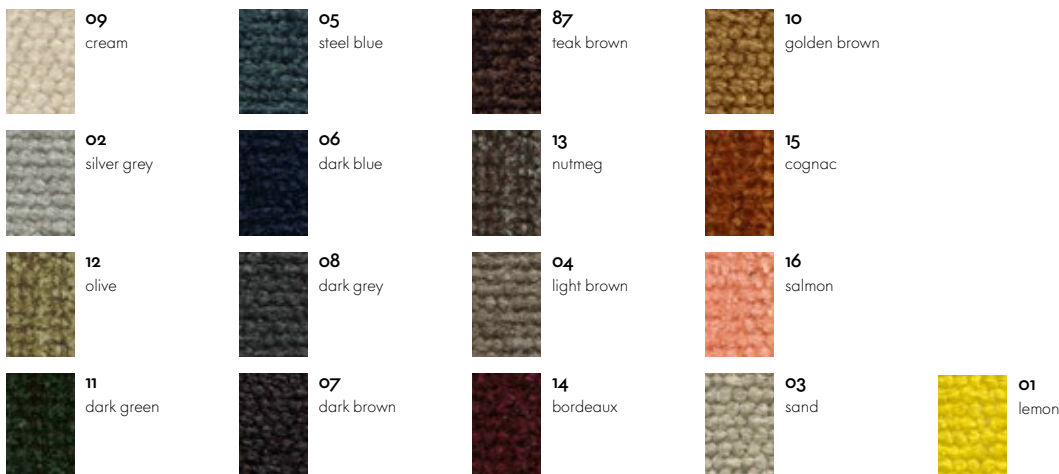

Laser RE

Home/Office, F40

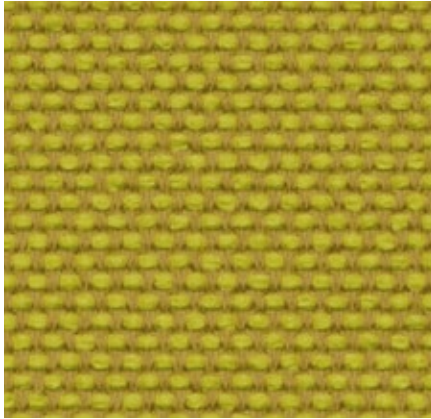

The environmentally friendly fabric Laser RE is made from recycled polyester. It has a distinctive woven appearance, which is particularly accentuated by contrasting duotones in a varied palette of 25 colours. Practical and easy to care for, as well as durable and highly abrasion-resistant, Laser RE is also well suited for office environments.

Laser RE is available in 25 colours.

Material	100% recycled polyester
Weight	520 g/m ²
Width	144 cm +/- 2 cm
Abrasion resistance	100,000 Martindale
Fastness to light	Type 6
Pilling	Grade 4-5
Fastness to rubbing	Grade 4-5 dry and wet

Alcove
Alcove Plus
Citizen
HAL Lounge Chair
ID Chair Concept

ID Visitor
Mariposa Club Armchair
Mariposa Sofa
Soft Modular Sofa
Soft Seats

Softshell Chair
Suita Club Armchair
Suita Club Sofa
Suita
Visiona Stool

Laser RE

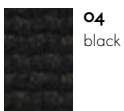

LightNet

Home/Office

vitra.

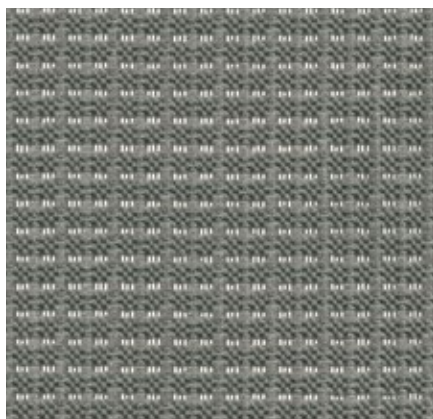

LightNet is a subtly textured, breathable mesh fabric with a soft feel. Due to the type of weave, LightNet has a square pattern with a transparent effect in the vertical direction. This robust mesh fabric made of polyester and polyamide comes in tone-in-tone colours and is ideally suited to the demanding conditions of office environments.

LightNet is available in 3 colours.

Material	60% polyamide, 40% polyester
Weight	380 g/m ² (11.2 oz/y ²)
Width	125 cm +/- 3 cm (49")
Abrasion resistance	100,000 Martindale
Fastness to light	Type 6
Pilling	Grade 4-5
Fastness to rubbing	Grade 4-5 dry and wet

AM Chair Netweave backrest

LightNet



01
black



02
sierra grey



03
white

Linho

Home, F80



The high-quality linen fabric Linho is manufactured in Belgium, from the plant to the finished textile. It has the slightly irregular appearance that is typical of linen yarn. Due to its high percentage of linen, Linho tends to form elegant creases, lending a natural look to soft upholstered furniture.

Linho is available in 10 colours.

Material	9% polyamide, 91% linen
Weight	450 g/m ² (13.3 oz/y ²)
Width	137 cm +/- 2 cm (54")
Abrasion resistance	18,000 Martindale
Fastness to light	Type 5
Pilling	Grade 3
Fastness to rubbing	Grade 3 dry and wet

Grand Sofà
Mariposa Club Armchair
Mariposa Sofa
Soft Modular Sofa
Softshell Chair

Suita Club Armchair
Suita

Linho



07
olive

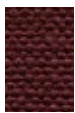

06
chestnut

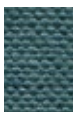

08
steel blue

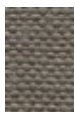

03
truffle



09
atlantic

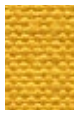

04
canola



02
sand



10
moor brown



05
rose quartz



01
pearl

Mello

Home, F40

vitra.

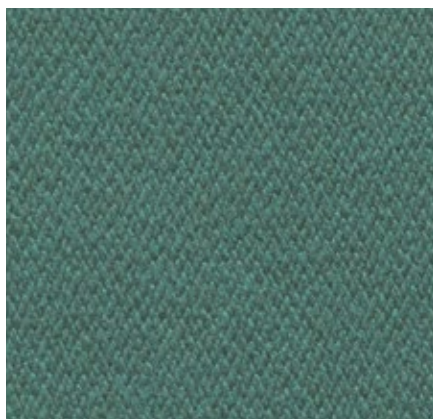

Mello is an elegant cotton fabric with a pleasant softness and cool tactile qualities. Thanks to a thicker melange yarn of recycled cotton, the robust twill weave has a lively yet balanced appearance. The understated colour palette for Mello ranges from pastel tones to natural, earthy shades and darker hues.

Mello is available in 9 colours.

Material	80% cotton, 20% polyester
Weight	530 g/m ² (15.6 oz/y ²)
Width	142 cm +/- 2 cm (56")
Abrasion resistance	30,000 Martindale
Fastness to light	Type 5
Pilling	Grade 4
Fastness to rubbing	Grade 3-4 dry and wet

Cité
Grand Sofà
Mariposa Club Armchair
Mariposa Sofa

Soft Modular Sofa
Suita Club Armchair
Suita

Mello

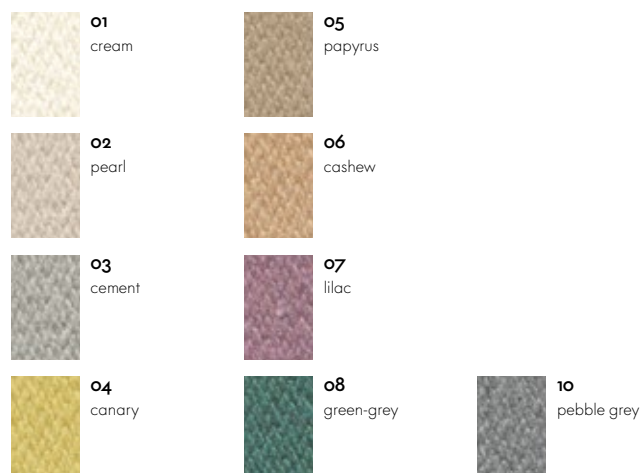

Netline

Home/Office

vitra.



Netline is a technical knit that makes an ideal cover material for the backrests of chairs, thanks to its elasticity. The semi-transparent mesh look of Netline emphasises its technical properties.

Netline is available in 2 colours.

Material	100% polyester
Weight	360 g/m ² (10.6 oz/y ²)
Abrasion resistance	40,000 Martindale
Fastness to light	Type 6
Pilling	Grade 4-5
Fastness to rubbing	Grade 4-5 dry and wet

MedaSlim

Netline (backrest only)

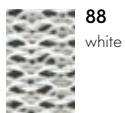

88
white

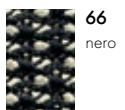

66
nero

Netweave

Home/Office

vitra.

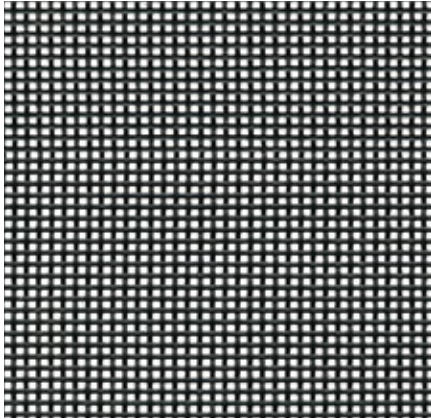

The semi-transparent, self-supporting netweave fabric combines a robust structure with an elegant, airy appearance. It is available in 2 colours.

Material	71% polyurethane, 29% polyester
Weight	630 g/m ² (18.6 oz/y ²)
Width	138 cm (54")
Fastness to light	Type 6
Fastness to rubbing	Grade 4-5 dry and wet

Aluminium Group

Netweave



66
nero



05
dark grey

Nova

Home/Office, F20

vitra.



Nova is a classic fabric for use in office environments. Distinguished by a fine texture, this extremely robust and hard-wearing fabric has a soft surface sheen. The economical fabric serves as an ideal cover material for panels.

Nova is available in 1 colour.

Material	100% polyester
Weight	400 g/m ² (11.8 oz/y ²)
Width	142 cm +/- 2 cm (56")
Abrasion resistance	60,000 Martindale
Fastness to light	Type 6
Pilling	Grade 4-5
Fastness to rubbing	Grade 4-5 dry and wet

MedaSlim

Nova

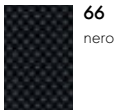

Nubia

Home, F100

vitra.



Nubia is a blended fabric with a very lively, natural appearance. Its fine substructure is interspersed with voluminous bouclé yarn, which gives the fabric depth and a soft, inviting touch. The varying combinations of yarns in natural tones yield either contrasting or calm colour compositions with a distinctly Mediterranean flair.

Nubia is available in 6 colours.

Material	2% polyamide, 30% new wool, 25% polyacrylics, 43% polyester
Weight	570 g/m ² (16.8 oz/y ²)
Width	140 cm (55")
Abrasion resistance	35,000 Martindale
Fastness to light	Type 5
Pilling	Grade 4
Fastness to rubbing	Grade 3-4 dry and wet

Fauteuil de Salon
Fauteuil Direction
Grand Relax
Grand Sofà
HAL Lounge Chair

Mariposa Club Armchair
Mariposa Sofa
Petit Repos
Repos & Grand Repos
Soft Modular Sofa

Suita
Suita Club Armchair

Nubia

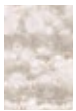

01
ivory/pearl



02
cream/pearl



03
cream/sand



06
cream/sierra
grey



04
bamboo/terra

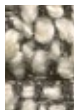

05
cream/dark
brown

Olimpo

Home, F60

vitra.

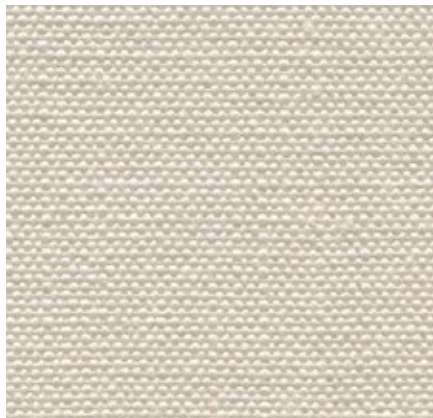

The typical linen texture of Olimpo gives the fabric a very fine and natural overall appearance. The fabric's high percentage of linen, clearly evident to the touch, results in comfortably cool conditions for the sitter. Thanks to the combination of viscose and linen, the fabric is durable and abrasion-resistant and exhibits a fine sheen.

Olimpo is available in 10 colours.

Material	70% linen, 30% rayon
Weight	520 g/m ² (15.3 oz/y ²)
Width	146 cm +/- 3 cm (57")
Abrasion resistance	30,000 Martindale
Fastness to light	Type 5
Pilling	Grade 3-4
Fastness to rubbing	Grade 3-4 dry and wet

Mariposa Club Armchair

Mariposa Sofa

Soft Modular Sofa

Suita Club Armchair

Suita

Olimpo



10
sierra grey

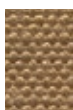

08
kalahari



06
graphite grey

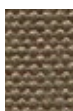

05
taupe grey



11
atlantic

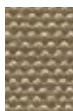

04
sandstone

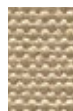

07
parchment

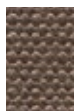

09
mokka

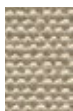

03
bamboo



02
pearl

Plano

Home/Office, F30

vitra.

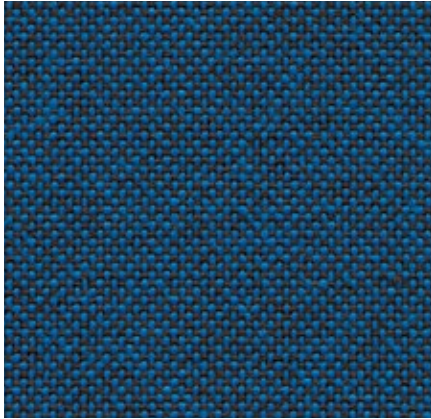

Plano is a robust plain weave with a flat, even texture. The wide palette of duotones with new, delicate washed-out shades includes many relatively neutral hues, a good number of which are coordinated with the Hopsak colour range. Thanks to its durability and longevity, Plano is also an ideal choice for office furnishings.

Plano is available in 39 colours.

Material	100% polyester
Weight	265 g/m ² (7.8 oz/y ²)
Width	142 cm +/- 2 cm (56")
Abrasion resistance	80,000 Martindale
Fastness to light	Type 6
Pilling	Grade 4-5
Fastness to rubbing	Grade 4-5 dry and wet

AC 5 Group
AM Chair fabric backrest
Citizen
HAL Soft
ID Chair Concept
ID Visitor

Mariposa Club Armchair
MedaSlim
Rookie
Soft Seats
Softshell Chair
Unix Chair

HAL **Seat cover, Plano (for orders of 6 or more)**

Plano

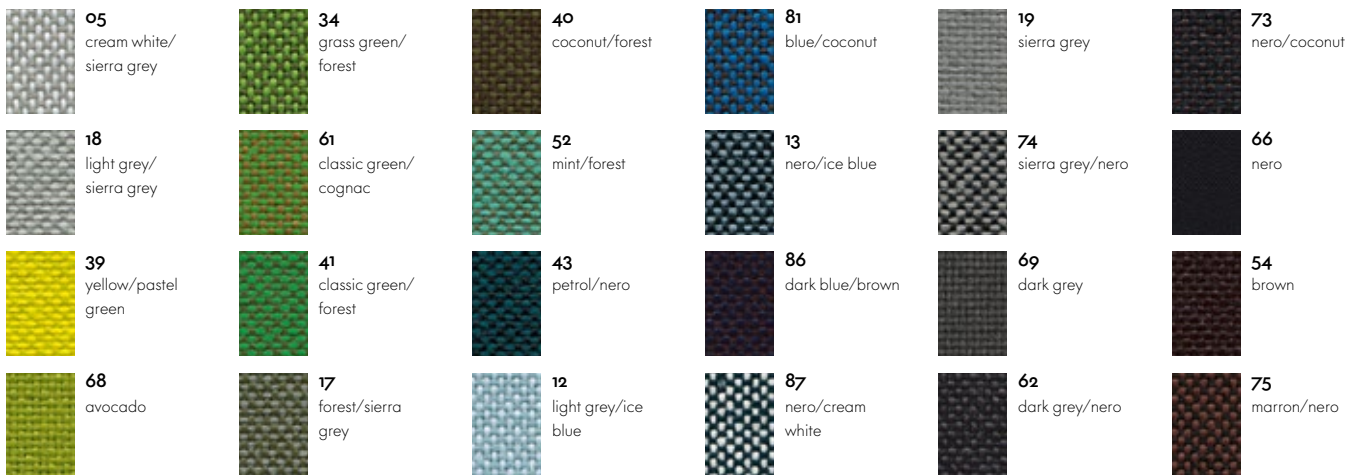

HAL Seat cover, Plano



Planum

Home

vitra.

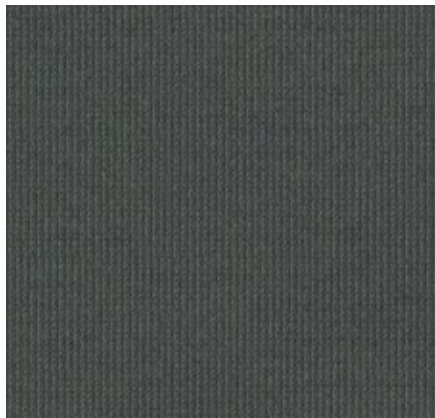

Planum is a hard-wearing, knitted upholstery fabric with a light matt sheen, which gives it a soft appearance. Its fine smooth surface has a dry feel. The knit fabric is suited for private settings as well as public spaces, and can be optimally combined with the multiple shades of the textile Drop.

Planum is available in 3 colours.

Material	14% nylon, 44% new wool, 42% polyester
Weight	400 g/m ² (11.8 oz/y ²)
Width	162 cm +/- 2 cm (63'')
Abrasion resistance	100,000 Martindale
Fastness to light	Type 5-6
Pilling	Grade 4
Fastness to rubbing	Grade 4-5 dry and wet

Abalon

Planum



01
silver grey (111)



02
dark green (971)



03
black (1191)

Reed

Home, F100

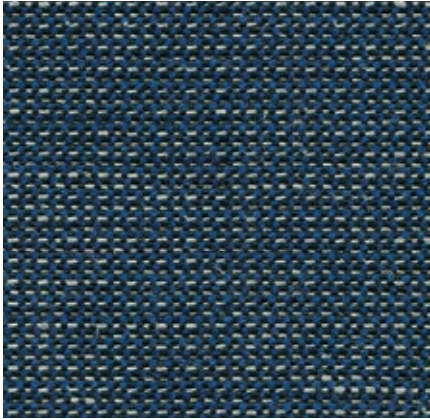

The elegant finely patterned fabric Reed is a blend of linen, wool and cotton. The structure of the fabric designed by Hella Jongerius has a hand-made look, its irregular lively linen yarn lending the fabric a natural expression. Reed is cool and soft to the touch and can be perfectly combined with other fabrics and materials.

Reed is available in 19 colours.

Material	7% polyamide, 48% cotton, 25% new wool, 20% linen
Weight	400 g/m ² (11.8 oz/y ²)
Width	142 cm +/- 2 cm (56")
Abrasion resistance	50,000 Martindale
Fastness to light	Type 5
Pilling	Grade 3-4
Fastness to rubbing	Grade 3-4 dry and wet

Grand Sofà
 Mariposa Club Armchair
 Mariposa Sofa
 Soft Modular Sofa
 Softshell Chair

Suita

Reed



Reflect

Home/Office, F40

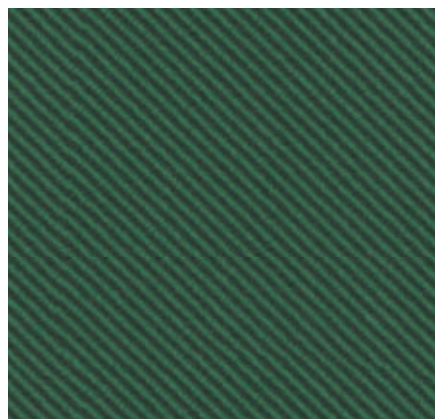

Reflect is a sustainable fabric made of recycled polyester. Its twill weave offers a fine surface texture that is soft to the touch. As a highly robust material, Reflect meets the stringent requirements for use in public spaces.

Hella Jongerius has designed nine colours, which are harmoniously coordinated with the Vitra Colour & Material Library. The Kvadrat palette extends the selection by a further 35 hues. Slight variations in colour may occur.

Material	100% recycled polyester
Weight	310 g/m ²
Width	142 cm +/- 2 cm (56")
Abrasion resistance	100,000 Martindale
Fastness to light	Type 6
Pilling	Grade 4-5
Fastness to rubbing	Grade 4-5 dry and wet

ID Chair Concept
ID Visitor

Reflect



Savana

Home, F8o

vitra.

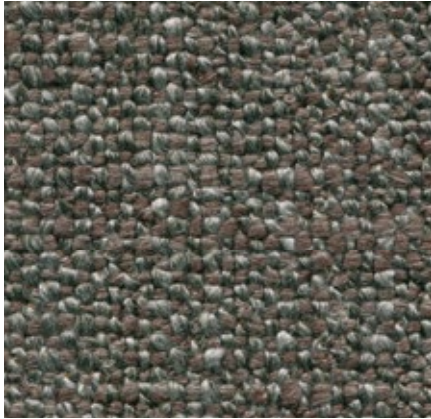

Savana is a blended fabric woven from yarns of varying thickness, which give it an irregular texture with a lively and elegant appearance. A palette of subdued and natural earth tones, along with the dry, pleasant feel of the textile, emphasise the fabric's Italian flair.

Savana is available in 8 colours.

Material	8% polyamide, 19% cotton, 50% polyacrylics, 23% linen
Weight	820 g/m ² (24.2 oz/y ²)
Width	140 cm (55")
Abrasion resistance	30,000 Martindale
Fastness to light	Type 5
Pilling	Grade 3-4
Fastness to rubbing	Grade 3-4 dry and wet

Grand Sofà
Mariposa Club Armchair
Mariposa Sofa
Soft Modular Sofa

Suita Club Armchair
Suita

Savana



01
pearl melange



05
pebble melange



02
sand melange



06
sierra grey melange



03
mauve melange



07
nutmeg melange

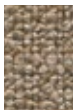

04
papyrus melange

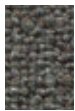

08
graphite melange

Silk Mesh

Home/Office



Silk Mesh is a three-dimensional spacer fabric. Thanks to the air cells in the regular honeycomb structure, the fabric not only provides a comfortable cushioning effect but also ensures a pleasant seating climate. Silk Mesh is extremely robust and well suited for use in office environments.

Silk Mesh is available in 7 colours.

Allstar
ID Air
ID Mesh
ID Soft
ID Visitor Air

ID Visitor Mesh
Unix Chair

Material 100% polyester
Weight 300 g/m² (8.8 oz/y²)
Width 170 cm +/- 3 cm (67")
Abrasion resistance 40,000 Martindale
Fastness to light Type 6
Pilling Grade 4-5
Fastness to rubbing Grade 4-5 dry and wet

Silk Mesh



24
soft grey

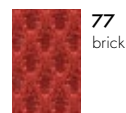

77
brick



21
dim grey

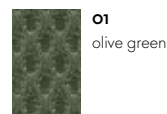

01
olive green

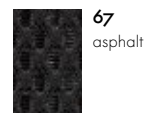

67
asphalt

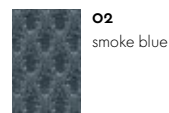

02
smoke blue

Material 33% polyamide,
67% polyester
Weight 300 g/m² (8.8 oz/y²)
Width 170 cm +/- 3 cm (67")
Abrasion resistance 100,000 Martindale
Fastness to light Type 6
Pilling Grade 4-5
Fastness to rubbing Grade 4-5 dry and wet

Silk Mesh

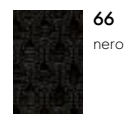

66
nero

Home

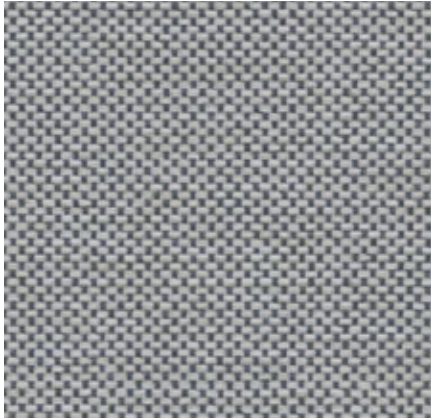

The robust outdoor textile made of polypropylene yarn is characterised by its smooth flat weave. Simmons has antibacterial properties and is resistant to UV light, water and mildew. The fabric dries quickly and can be easily washed and cleaned.

Simmons is available in 3 colours.

Material	83% polypropylene, 17% polyester
Weight	330 g/m ²
Width	140 cm
Abrasion resistance	30,000 Martindale
Fastness to light	Type 7-8
Pilling	Grade 4-5
Fastness to rubbing	Grade 4-5 dry, Grade 4 wet

Soft Seats

Simmons

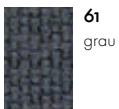

SingleKnit

Home/Office

vitra.



SingleKnit is a precision knit component cover developed specifically for the Pivot office chair. The knit texture of the fabric helps to prevent users from slipping on the seat surface. This robust technical knit is ideally suited for office applications.

SingleKnit is available in 5 colours.

Material	5% spandex, 95% polyester
Weight	475 g/m ² (14 oz/y ²)
Abrasion resistance	40,000 Martindale
Fastness to light	Type 6
Pilling	Grade 4-5
Fastness to rubbing	Grade 4-5 dry and wet

Pivot Counter Stool
Pivot High Stool
Pivot Stool

SingleKnit



01
light grey



04
dark grey



05
black



03
brown



02
red

Striped Knit

Home/Office

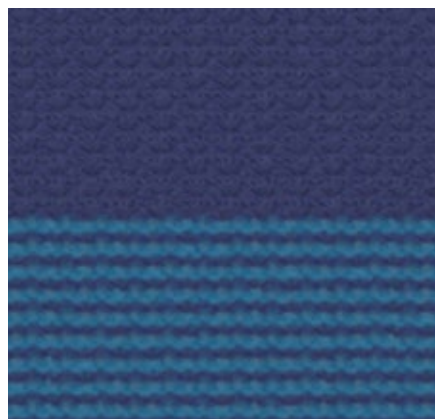

Striped Knit is a form-fitted knit fabric for the backrest of ID Soft. Its lightly textured surface and striped pattern add a fresh home-like accent to any office environment.

Striped Knit exists in a choice of two colour versions.

Material	4% spandex, 96% polyester
Weight	540 g/m ² +/- 10%
Abrasion resistance	40,000 Martindale
Fastness to light	Type 6
Pilling	Grade 4-5
Fastness to rubbing	Grade 4-5 dry and wet

ID Soft

Striped Knit

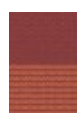

O1
brick/orange



O2
ink blue/turquoise

Tonus

Home, F100

vitra.



Tonus is a classic woollen cloth in a plain weave with an appealingly soft and flexible feel. The deep intensity of Tonus colours – ranging from warm and earthy golds that evoke oriental myths and spices to cool nordic hues in the aquamarine spectrum – lend a unique richness to the fabric.

Tonus is available in 14 colours.

Material	90% new wool, 10% helanca
Weight	490 g/m ² (14.5 oz/y ²)
Width	140 cm (55")
Abrasion resistance	100,000 Martindale
Fastness to light	Type 5
Pilling	Grade 3
Fastness to rubbing	Grade 3-4 dry and wet

Amoebe Visiona Stool

Tonus



Cone Chair Heart Cone Chair

Organic Chair

Living Tower

Tonus



Tonus

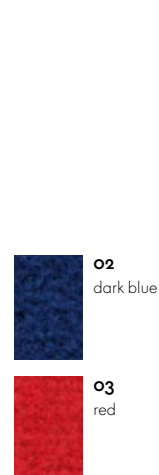

Track

Home/Office, F120

vitra.

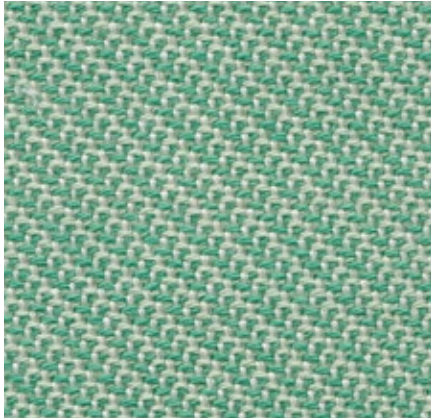

Track is a medium-weight woollen fabric with a subtle pattern of fine diagonal stripes, which gives it a sporty, fresh appearance. Thanks to its high quality, the fabric is suited for office environments, but also adds a beautiful touch to home interiors.

Track is available in 25 colours.

Material	10% polyamide, 90% new wool
Weight	480 g/m ² (14.2 oz/y ²)
Width	143 cm +/- 2 cm (56")
Abrasion resistance	100,000 Martindale
Fastness to light	Type 6
Pilling	Grade 4-5
Fastness to rubbing	Grade 4-5 dry and wet

Alcove
Alcove Plus
Citizen
Soft Modular Sofa
Soft Work

Track

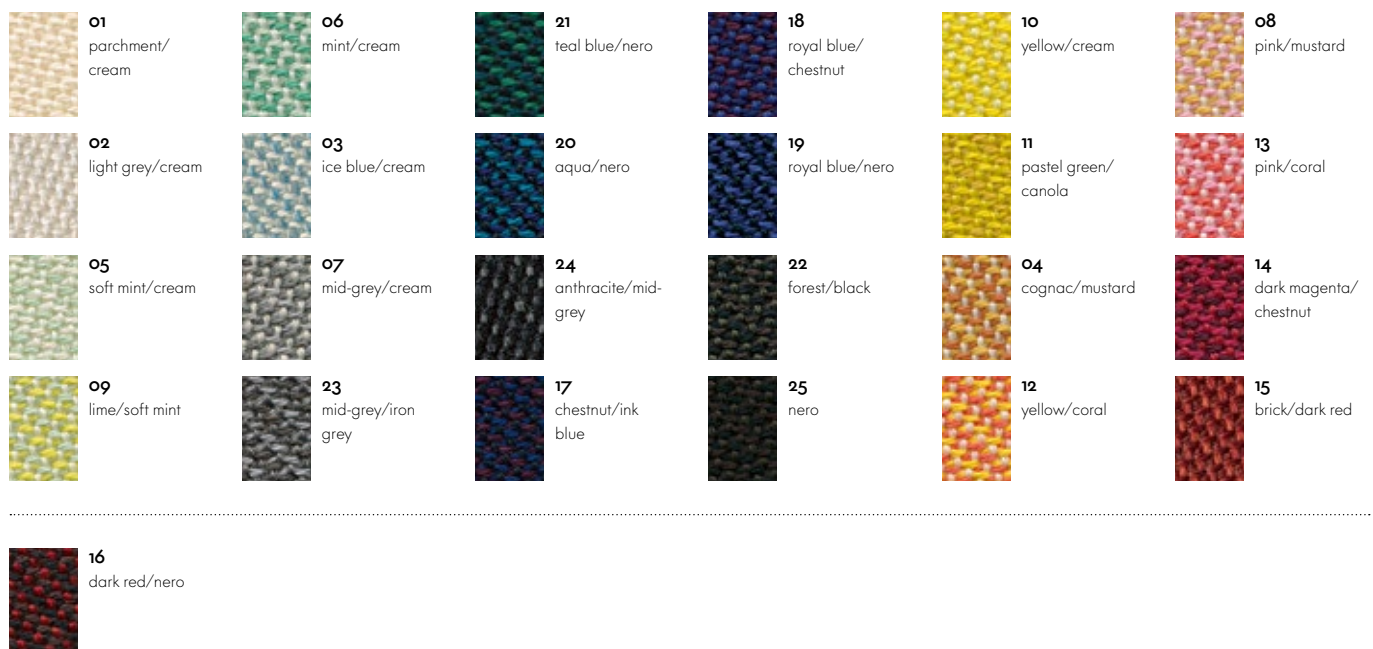

Tress

Home/Office, F80

vitra.

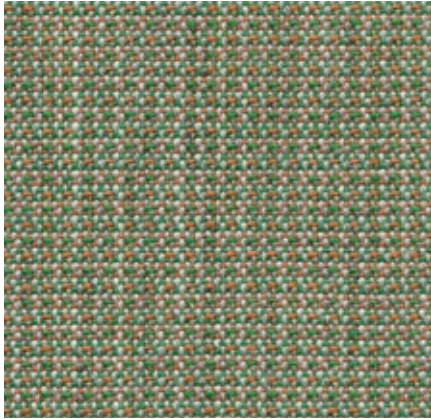

Tress is a flat woven fabric with a lively appearance that derives from the contrast between its even structure and the natural melange of colours. The combination of yarns with varied hues creates a harmonious and yet vibrant look. Thanks to its high wool content, Tress is a durable, easy-care material with a home-like aesthetic.

Tress is available in 22 colours.

Material	8% polyamide, 73% new wool, 19% polyester
Weight	310 g/m ² (9.1 oz/y ²)
Width	142 cm +/- 2 cm (56")
Abrasion resistance	40,000 Martindale
Fastness to light	Type 6
Pilling	Grade 4-5
Fastness to rubbing	Grade 4-5 dry and wet

Alcove
Alcove Plus
Allstar
Fauteuil de Salon
Fauteuil Direction

Fauteuil Direction Pivotant
Rookie
Soft Modular Sofa
Soft Seats
Softshell Chair

Tress

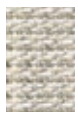

01
light grey
melange

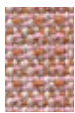

05
pale rose
melange



09
brown
melange

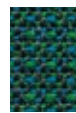

13
teal blue
melange



17
plum
melange

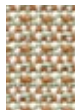

02
papyrus
melange



06
ice grey
melange



10
pebble
melange



14
brandy
melange



18
royal blue
melange

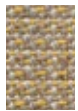

03
camel
melange



07
emerald
melange



11
blue-grey
melange

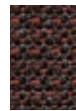

15
chestnut
melange



19
blue
melange



21
anthracite
melange

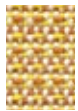

04
canola
melange



08
aubergine
melange



12
steel blue
melange



16
blackberry
melange



20
mid-grey
melange



22
black
melange

TrioKnit

Home/Office

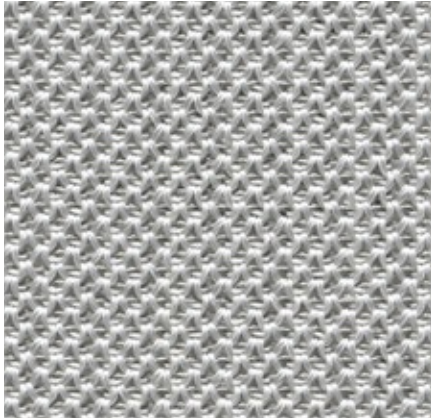

TrioKnit is a strong, self-supporting knit fabric with a fine sheen. The robust quality and slightly technical look of TrioKnit make it well suited for office environments. Thanks to the fabric's subdued colour palette, it can be easily combined with other materials.

TrioKnit is available in 6 colours.

Material	4% spandex, 96% polyester
Weight	607 g/m ² (17.9 oz/y ²)
Abrasion resistance	40,000 Martindale
Fastness to light	Type 6
Pilling	Grade 4-5
Fastness to rubbing	Grade 4-5 dry and wet

Physix

TrioKnit



07
silver grey



09
ice grey



08
pebble grey



10
brick



03
reed



06
black pearl

Twill

vitra.

Home/Office, F60

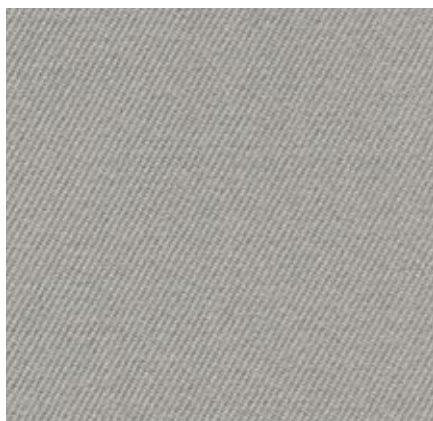

The high percentage of natural fibres gives Twill very pleasant tactile qualities and an inviting appearance. Extremely durable with excellent abrasion resistance, it combines the qualities typically found in home furnishings with the demanding requirements of the project sector.

Twill is available in 18 colours.

Material	30% polyamide, 70% new wool
Weight	325 g/m ² (9.6 oz/y ²)
Width	155 cm +/- 2 cm (61")
Abrasion resistance	100,000 Martindale
Fastness to light	Type 6
Pilling	Grade 4-5
Fastness to rubbing	Grade 4-5 dry and wet

AC 5 Group
Fauteuil de Salon
Fauteuil Direction
Fauteuil Direction Pivotant
ID Chair Concept

ID Visitor
Rookie
Soft Seats
Softshell Chair
Visiona Stool

Twill



Volo

vitra.

Home/Office, F60



Volo is a finely structured wool blend with a refined weave that gives it an elegant appearance. This expressive textile shows strong solid colours to full advantage while simultaneously offering pleasant tactile qualities. With its soft look and appealing texture, Volo is a perfect fit for home interiors, but it is also well suited for use in the contract sector.

Volo is available in 17 colours.

Material	15% polyamide, 85% new wool
Weight	435 g/m ² (12.8 oz/y ²)
Width	145 cm +/- 3 cm (57")
Abrasion resistance	100,000 Martindale
Fastness to light	Type 6
Pilling	Grade 4-5
Fastness to rubbing	Grade 4-5 dry and wet

Alcove
Alcove Plus
Allstar
Amoebe
Fauteuil de Salon
Fauteuil Direction
Fauteuil Direction Pivotant
HAL Lounge Chair

HAL Soft
ID Chair Concept
ID Visitor
Mariposa Club Armchair
Mariposa Sofa
Petit Repos
Repos & Grand Repos
Rookie

Soft Modular Sofa
Soft Seats
Softshell Chair
Suita Club Armchair
Suita Club Sofa
Suita
Visiona Stool

Volo

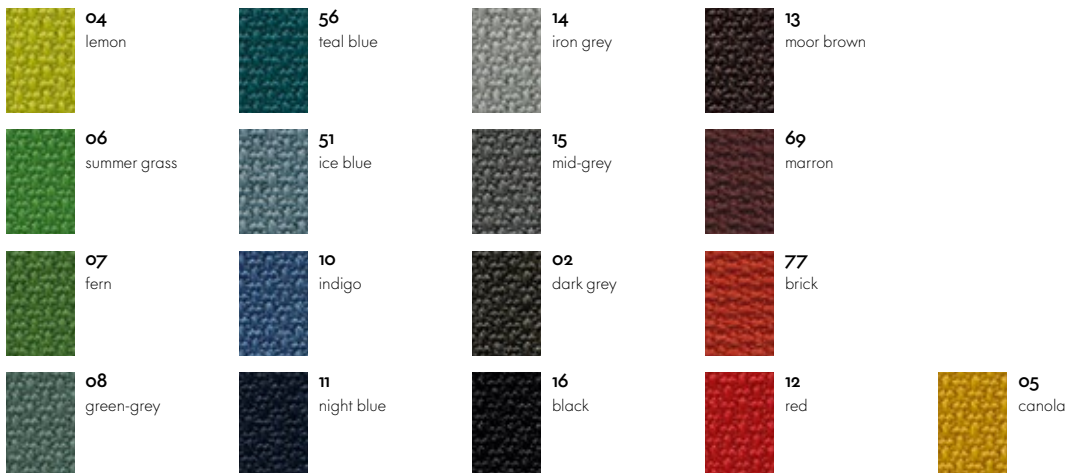

Overview of cover materials

Textiles with a price group

		Material	Width	Weight	Abrasion resistance (Martindale)	
F20	Nova	100% polyester	142 cm +/- 2 cm (56")	400 g/m ² (11.8 oz/y ²)	60,000	
F30	Plano	100% polyester	142 cm +/- 2 cm (56")	265 g/m ² (7.8 oz/y ²)	80,000	
F40	Laser RE	100% recycled polyester	144 cm +/- 2 cm	520 g/m ²	100,000	
	Mello	80% cotton, 20% polyester	142 cm +/- 2 cm (56")	530 g/m ² (15.6 oz/y ²)	30,000	
	Reflect	100% recycled polyester	142 cm +/- 2 cm (56")	310 g/m ²	100,000	
F60	Hopsak	100% polyamide	127 cm +/- 2 cm (50")	550 g/m ² (16.2 oz/y ²)	200,000	
	Olimpo	70% linen, 30% rayon	146 cm +/- 3 cm (57")	520 g/m ² (15.3 oz/y ²)	30,000	
	Twill	30% polyamide, 70% new wool	155 cm +/- 2 cm (61")	325 g/m ² (9.6 oz/y ²)	100,000	
	Volo	15% polyamide, 85% new wool	145 cm +/- 3 cm (57")	435 g/m ² (12.8 oz/y ²)	100,000	
F80	Corsaro	5% polyamide, 10% cotton, 46% polyacrylics, 5% linen, 20% wool, 14% polyester	140 cm +/- 2 cm (55")	450 g/m ² (13.3 oz/y ²)	35,000	
	Cosy 2	20% polyamide, 80% new wool	154 cm +/- 2 cm (60")	590 g/m ² (17.4 oz/y ²)	50,000	
	Dumet	9% polyamide, 46% cotton, 8% linen, 22% wool, 15% rayon	147 cm +/- 2 cm (57")	485 g/m ² (14.3 oz/y ²)	40,000	
	Iroko 2	32% cotton, 48% polyacrylics, 20% polyester	152 cm +/- 3 cm (60")	700 g/m ² (20.6 oz/y ²)	40,000	
	Linho	9% polyamide, 91% linen	137 cm +/- 2 cm (54")	450 g/m ² (13.3 oz/y ²)	18,000	
	Savana	8% polyamide, 19% cotton, 50% polyacrylics, 23% linen	140 cm (55")	820 g/m ² (24.2 oz/y ²)	30,000	
	Tress	8% polyamide, 73% new wool, 19% polyester	142 cm +/- 2 cm (56")	310 g/m ² (9.1 oz/y ²)	40,000	
	F100	Aura	3% polyamide, 97% new wool	144 cm +/- 2 cm (56")	390 g/m ² (11.5 oz/y ²)	20,000
		Nubia	2% polyamide, 30% new wool, 25% polyacrylics, 43% polyester	140 cm (55")	570 g/m ² (16.8 oz/y ²)	35,000
		Reed	7% polyamide, 48% cotton, 25% new wool, 20% linen	142 cm +/- 2 cm (56")	400 g/m ² (11.8 oz/y ²)	50,000
Tonus		90% new wool, 10% helanca	140 cm (55")	490 g/m ² (14.5 oz/y ²)	100,000	
F120	Credo	5% polyamide, 95% new wool	145 cm +/- 2 cm (57")	640 g/m ² (18.9 oz/y ²)	100,000	
	Track	10% polyamide, 90% new wool	143 cm +/- 2 cm (56")	480 g/m ² (14.2 oz/y ²)	100,000	
F200	Checker	77% cotton, 23% polyester	140 cm (55")	467 g/m ² (13.8 oz/y ²)	20,000	

Textiles with no price group

	Material	Width	Weight	Abrasion resistance (Martindale)
Coda	10% nylon, 90% new wool	140 cm (55")	860 g/m ² (25.4 oz/y ²)	100,000
Diamond Mesh	100% polyester	165 cm (64")	600 g/m ² (17.7 oz/y ²)	45,000
Drop	20% nylon, 60% new wool, 20% polyester	157 cm +/- 2 cm (61")	520 g/m ² (15.3 oz/y ²)	80,000
FleeceNet	46% polyamide, 1% spandex, 53% polyester	135 cm +/- 2 cm (53")	430 g/m ² (12.7 oz/y ²)	100,000
Intreccio	23% cotton, 77% new wool	140 cm (55")	780 g/m ² (23 oz/y ²)	18,000
LightNet	60% polyamide, 40% polyester	125 cm +/- 3 cm (49")	380 g/m ² (11.2 oz/y ²)	100,000
Netweave Aluminium Chair	71% polyurethane, 29% polyester	138 cm (54")	630 g/m ² (18.6 oz/y ²)	n/a
Planum	14% nylon, 44% new wool, 42% polyester	162 cm +/- 2 cm (63")	400 g/m ² (11.8 oz/y ²)	100,000
Silk Mesh nero	33% polyamide, 67% polyester	170 cm +/- 3 cm (67")	300 g/m ² (8.8 oz/y ²)	100,000
Silk Mesh colours	100% polyester			40,000
Simmons	83% polypropylene, 17% polyester	140 cm	330 g/m ²	30,000
Vinyl ETS	15% cotton, 85% PVC	140 cm (55")	1,230 g/m ² (36.3 oz/y ²)	n/a
Duo Knit	4% spandex, 96% polyester		540 g/m ² +/- 10%	40,000 Martin-
Netline	100% polyester		360 g/m ² (10.6 oz/y ²)	40,000 Martin-
SingleKnit	5% spandex, 95% polyester		475 g/m ² (14 oz/y ²)	40,000 Martin-
Striped Knit	4% spandex, 96% polyester		540 g/m ² +/- 10%	40,000 Martin-
Tricot Slow Chair	100% polyester		607 g/m ² (17.9 oz/y ²)	40,000 Martin-
TrioKnit	4% spandex, 96% polyester		607 g/m ² (17.9 oz/y ²)	40,000 Martin-

Kvadrat fabrics are a further addition to Vitra's collection of durable, high-quality textiles. This expanded range makes it even easier to find the ideal upholstery fabric for a selected piece of Vitra furniture. The colours of the Kvadrat fabrics have been carefully chosen to match other Vitra surface finishes, offering a multitude of harmonious combinations. The complete colour palette of Kvadrat fabrics can be viewed at Kvadrat.dk.



Canvas 2, F60

This textile has a pronounced structure, making it especially suited for large surfaces.

The colours owe their exceptional richness to the use of up to six differently hued yarns per colour.

Hard-wearing and durable.

Canvas 2 is available in 45 colours.

Material

10% nylon, 90% new wool



Divina 3, F120

Piece-dyed, supple fabric with a directionless, smooth and uniform surface. The regular surface enhances the purity of the colours.

Hard-wearing and durable.

Divina 3 is available in 56 colours.

Material

100% new wool

**Divina MD**, F120

Supple material-dyed fabric with a smooth, directionless and consistent surface. Its full-bodied and subtle structure brings the nuanced range of colours to life and creates a vibrant appearance. Hard-wearing and durable.

Material

100% new wool

Divina MD is available in 27 colours.

**Divina Melange 3**, F120

Piece-dyed, supple fabric with a directionless, smooth and uniform surface. The lively melange effect is created by mixing undyed and black-dyed woollen yarns and then piece-dyeing after the weaving process. This creates a unique, dynamic look. Hard-wearing and durable.

Material

100% new wool

Divina Melange 3 is available in 38 colours.

**Hallingdal 65**, F140

Wool gives this material excellent durability and flexibility, while viscose enhances the brilliance and depth of the colours. A classic, timeless fabric in a wide selection of hues. Hard-wearing and durable.

Material

70% new wool, 30% rayon

Hallingdal 65 is available in 58 colours.

**Steelcut Trio 3**, F100

The innovative weave of this fabric creates a complex three-dimensional surface, and the combination of three different hues adds to its vibrant appearance.

Hard-wearing and durable.

Steelcut Trio 3 is available in 54 colours.

Material

10% nylon, 90% new wool

**Remix 3**, F80

The tight plain weave creates a subtle, minimalist surface texture. Each hue comprises a combination of up to six differently coloured yarns, yielding exceptional depth of colour.

Hard-wearing and durable.

Remix 3 is available in 72 colours.

Material

10% nylon, 90% new wool

**Tonus 4**, F100



























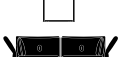

Thanks to the structural properties of Helanca yarn, Tonus is elastic and well suited for modern organic furniture. It brings colours to life in vibrant, precise fashion.

Hard-wearing and durable.

Tonus 4 is available in 47 colours.

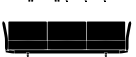
Material

90% new wool, 10% helanca

	Canvas 2	Diving 3	Divina Melange 3	Divina MD	Hallingdal 65	Remix 3	Steelcut Trio 3	Tonus 4
 AC 5 Work	•					•	•	
 Alcove Sofa Plus, Alcove Sofa	•	•	•	•	•	•	•	•
 Allstar	•	•	•	•	•	•		•
 AM Chair	•					•		
 Amoebe		•	•	•			•	•
 Dancing Wall	•	•	•			•	•	•
 EPA Full upholstery					•			
 EPC Full upholstery					•		•	•
 EPA & EPC Seat upholstery	•	•	•	•	•	•	•	•
 Fauteuil de Salon/ Fauteuil Direction	•	•	•	•	•	•	•	•
 HAL Lounge Chair		•	•	•				•
 HAL seat upholstery	•	•	•	•	•	•	•	•
 HAL Soft	•	•	•	•	•	•	•	•
 ID Soft, ID Mesh / ID Air / ID Cloud seat only	•	•	•	•	•	•	•	•
 ID Trim / ID Trim L	•				•	•	•	
 ID Visitor Soft, ID Visitor Mesh/Air seat only	•	•	•	•	•	•	•	•
 ID Visitor Trim	•				•	•	•	
 Mariposa		•	•	•			•	•
 Mariposa Club Armchair		•	•	•			•	•
 Organic Chair		•	•	•			•	•
 Repos / Grand Repos		•	•	•			•	•
 Petit Repos		•	•	•			•	•
 Rookie	•				•	•	•	•
 Soft Modular Sofa		•	•	•	•	•	•	•
 Softshell Chair	•	•	•	•	•	•	•	•
 Soft Work		•	•	•			•	•
 Suita / Suita Club		•	•	•			•	•
 Visiona Stool	•	•	•	•	•	•	•	•
 Wire Chair		•	•	•			•	
 Workbays		•	•		•	•	•	

Leather

Home/Office, L20



The standard grade leather used by Vitra is a robust cowhide leather, dyed-through, pigmented and embossed with an even grain pattern. Since it is hard-wearing and easy to maintain, it can also be used in office environments.

Leather is available in 16 colours.

Material	Robust cowhide with a distinctive, even grain
Fastness to light	Type 6
Thickness	1.1–1.3 mm
Fastness to rubbing	Grade 4 dry and wet

AC 5 Group
Allstar
Citizen
Coconut Chair
Eames Tandem Seating ETS
ID Trim/Trim L
ID Visitor Soft

Lobby Chair
MedaSlim
Rookie
Soft Modular Sofa
Soft Pad Chaise
Soft Seats
Softshell Chair

Suita Club Armchair
Suita Club Sofa
Suita

Leather



Elephant Pad

Plywood Group

Leather



Cover material (LCM Leather, LCW Leather)



Grand Executive & Grand Conference
 Petit Repos
 Repos & Grand Repos

Leather (contrast seam)

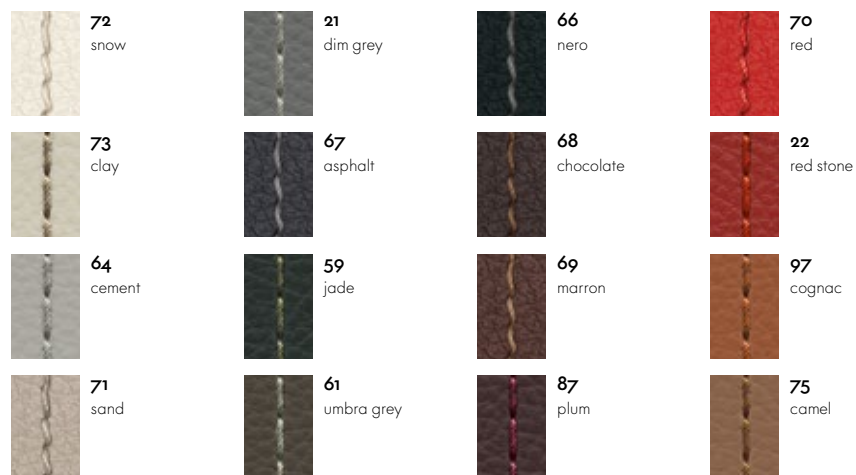

Eames Aluminium Group
 Eames Soft Pad Group

Leather/back panel Plano



Wire Chair

Leather/back panel
Leather

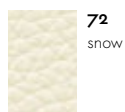

72
snow

Leather/back panel Plano



73/03
clay/parch-
ment/cream
white



64/05
cement/ cream
white/sierra
grey



71/80
sand/coffee



21/19
dim grey/sierra
grey



67/69
asphalt/dark
grey



59/40
jade/ coconut/
forest



61/69
umbra grey/
dark grey

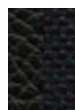

66/66
nero/nero



68/54
chocolate/
brown

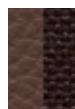

69/54
marron/brown

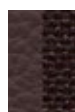

87/54
plum/brown



70/72
red/poppy red



22/96
red stone/ red/
cognac



97/67
cognac/cognac



75/80
camel/coffee

Leather Premium F

Home/Office, L50



Leather Premium F is a relatively smooth cowhide leather with a flat grain and fine top sheen. It is dyed-through, lightly pigmented and processed with a tanning agent extracted from olive tree leaves (a waste product of the olive harvest). Leather Premium F is available in 22 colours.

Material	Semi-aniline nappa leather with a very soft and supple feel, vegetable tanned
Fastness to light	Type 5
Thickness	1.1-1.3 mm
Fastness to rubbing	Grade 4 dry and wet

AC 5 Work
Cité
Citizen
Coconut Chair
Fauteuil de Salon

Fauteuil Direction & Pivotant
Grand Relax
HAL Lounge Chair
Lobby Chair
Soft Modular Sofa

Soft Seats
Softshell Chair
Suita
Suita Club Armchair
Suita Club Sofa

Leather Premium F



Eames Aluminium Group

Eames Soft Pad Group

Leather Premium F/back panel Plano



Grand Executive & Grand Conference
 Petit Repos
 Repos & Grand Repos

Soft Pad Chaise

Leather Premium F (contrast seam)



Lounge Chair

Leather Premium F
 (Santos palisander)



Leather Premium F
 (black-pigmented walnut)



Leather Premium F
 (white-pigmented walnut)



Lounge Chair

Leather Premium F
(American cherry)

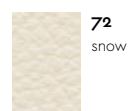

72
snow

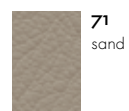

71
sand



61
umbra grey

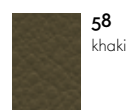

58
khaki

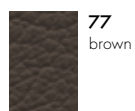

77
brown

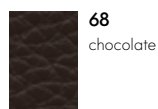

68
chocolate

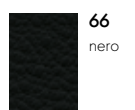

66
nero

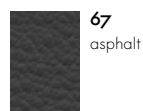

67
asphalt

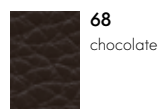

68
chocolate

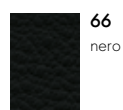

66
nero

Wire Chair

Leather Premium F/back panel Leather Premium F

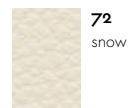

72
snow

Leather Premium F/back panel Plano



64/05
cement/cream
white/sierra
grey

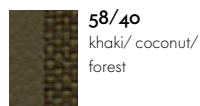

58/40
khaki/coconut/
forest

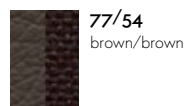

77/54
brown/brown

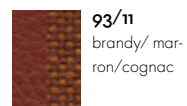

93/11
brandy/mar-
ron/cognac

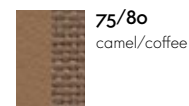

75/80
camel/coffee



65/19
granite/sierra
grey



61/69
umbra grey/
dark grey

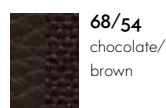

68/54
chocolate/
brown



22/96
red stone/red/
cognac



62/80
ochre/coffee



60/69
smoke blue/dark
grey



67/69
asphalt/dark
grey

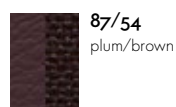

87/54
plum/brown

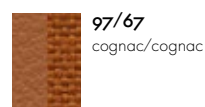

97/67
cognac/cognac

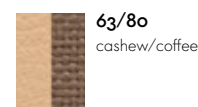

63/80
cashew/coffee



59/40
jade/coconut/
forest

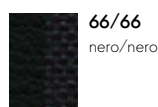

66/66
nero/nero



69/54
marron/brown

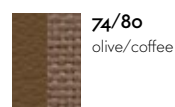

74/80
olive/coffee

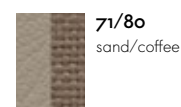

71/80
sand/coffee



73/70
clay/stone

Leather Natural F

Home, L6o

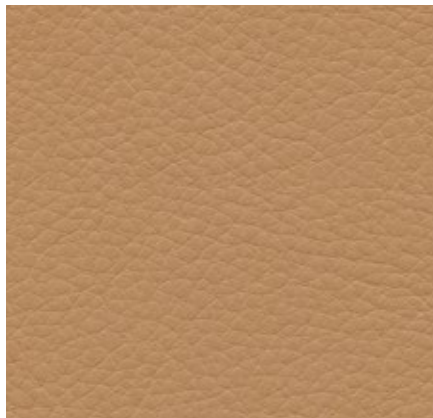

Leather Natural F is a very soft cowhide leather with an untreated grain. It is porous, breathable and acquires a lively patina through use. It is processed with a tanning agent extracted from olive tree leaves (a waste product of the olive harvest), and any chemicals used are harmless and applied in the smallest possible amounts.

Material

Aniline nappa leather with a natural open-pore grain, vegetable tanned

Fastness to light

Type 3

Thickness

1.1–1.3 mm

This sustainable aniline leather exists in a choice of 4 colours.

Petit Repos
Suita

Repos & Grand Repos

Leather Natural F

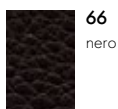
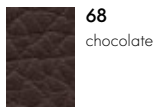
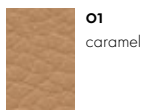
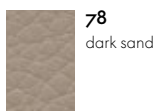

Leather Natural F (contrast seam)

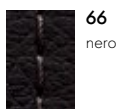
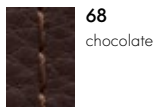
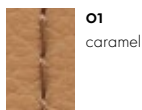
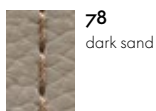

Lounge Chair

Leather Natural F (American cherry, Santos palisander, black-pigmented walnut)

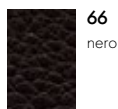
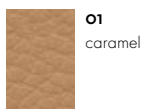
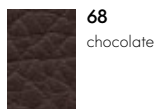
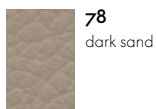

Leather Natural F (white-pigmented walnut)

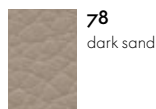

Leather Natural F (black ash)

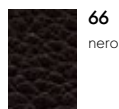
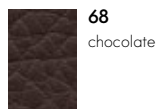

Leather Forte (deco)

Home/Office, L20



Leather Forte (deco) is of the same quality as Leather Forte, but features a decorative finish that is applied to the leather in a patented process. Leather Forte (deco) is available in 6 colours.

Material	Split leather with decorative finish
Fastness to light	Type 6
Thickness	1.8–2.0 mm

Grand Relax
Sofa Tray

Leather Forte (deco)



07
sand

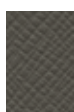

03
umbra grey



01
cognac (dark)

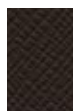

04
chocolate

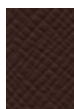

02
marron (dark)



05
nero

Leather Liso

Home/Office, L10

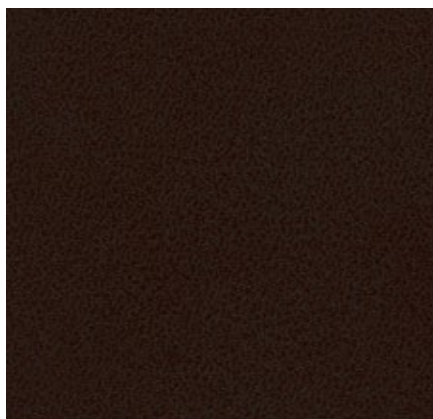

Leather Liso has a clean, smooth surface finish that gives it a contemporary appearance. Highly durable with good wear properties, this split leather comes in 2 colours.

Material
Fastness to light

Split leather
Type 6

Thickness

1.8–2.0 mm

Meda Gate

Leather Liso



66
nero

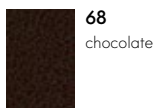

68
chocolate

Overview of cover materials

Leathers with a price group

		Material	Thickness
L10	Leather Liso	Split leather	1.8–2.0 mm
L20	Leather Forte (deco)	Split leather with decorative finish	1.8–2.0 mm
	Leather	Robust cowhide with a distinctive, even grain	1.1–1.3 mm
L50	Leather Premium F	Semi-aniline nappa leather with a very soft and supple feel, vegetable tanned	1.1–1.3 mm
L60	Leather Natural F	Aniline nappa leather with a natural open-pore grain, vegetable tanned	1.1–1.3 mm

Vitra uses a variety of high-quality plastics for its furniture products, depending on the desired characteristics. Special additives are employed in the manufacture of outdoor products to retard the fading of colours caused by UV radiation.

When it comes to plastics, it is always important to consider whether newer, more environmentally sensible alternatives are available. For this reason, four different plastics have been used in the production of the Panton Chair since 1967. The plastics most often used by Vitra are polypropylene and polymide, both of which are recyclable thermoplastics.

AC 5 Group
Base AC 5 Studio, Work

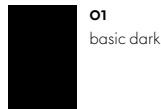

Pivot High Stool
 Pivot Stool
Base

MedaSlim
Backrest, seat and front legs

AM Chair
Base, armrests and back bracket

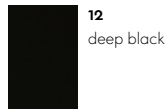

Allstar
Base

Algue

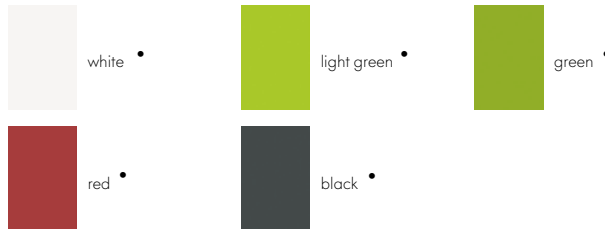

All Plastic Chair

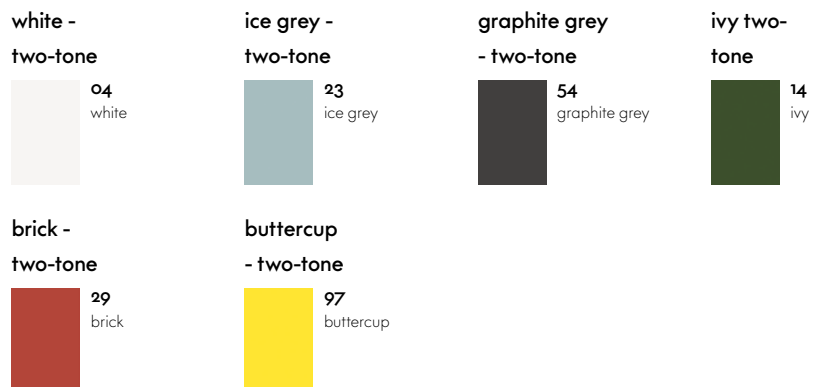

Allstar
Armrests/back bracket



Belleville Chair
Seat shell Plastic

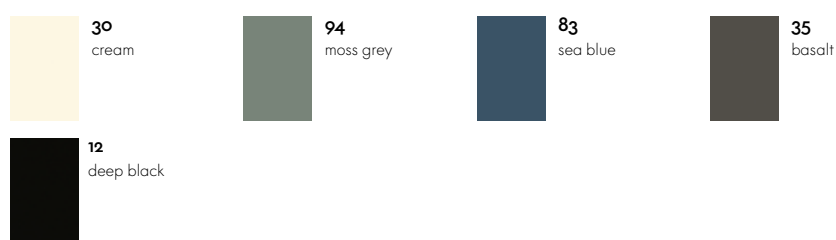

Corniches



Eames Elephant
Eames Elephant (Small)

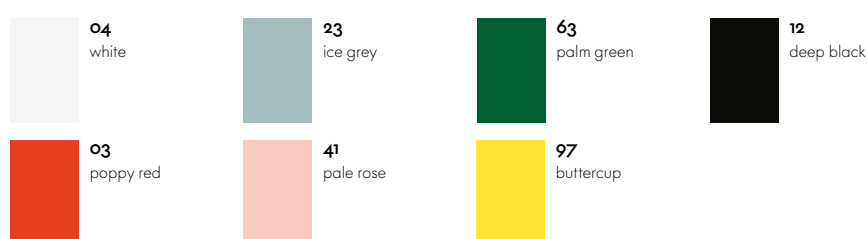

Eames Plastic Chairs
Seat shell

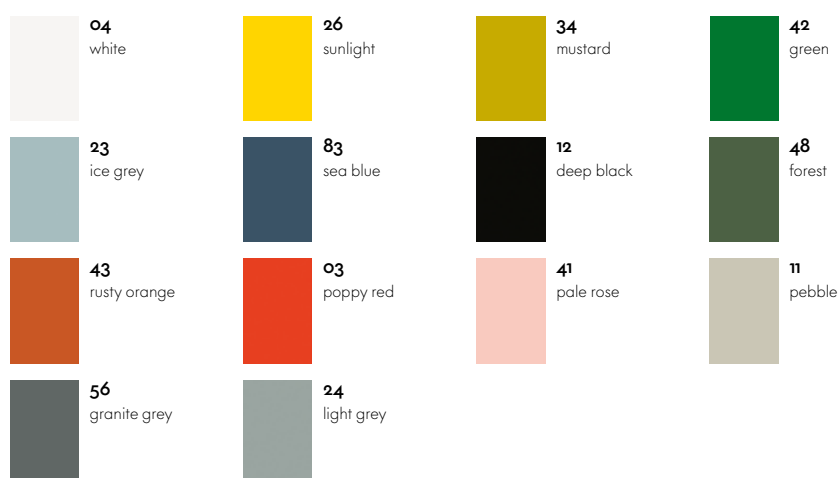

Elephant Stool

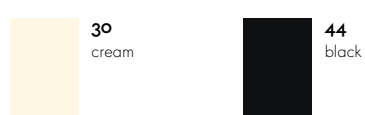

EVO-C



Happy Bin

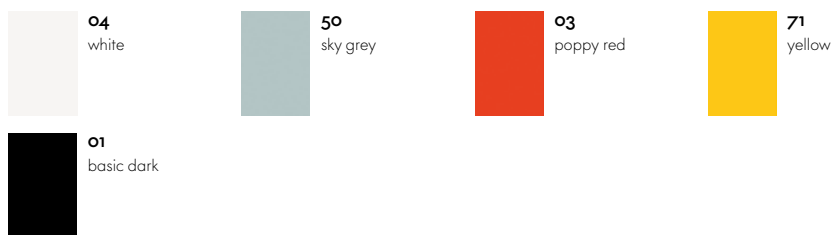

ID Air
ID Air Visitor
Backrest

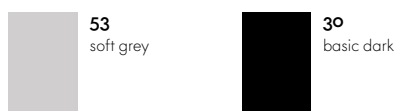

ID Chair Concept
Frame (armrests, back
bracket, mechanical unit)

Unix Chair
Frame

ID Chair Concept
Base



Softshell Chair
Four legged base

La Chaise
Seat shell

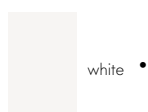

O-Tidy
S-Tidy



Panton Chair

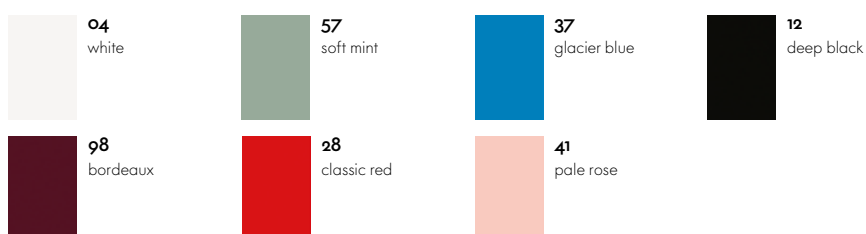

Panton Chair Classic

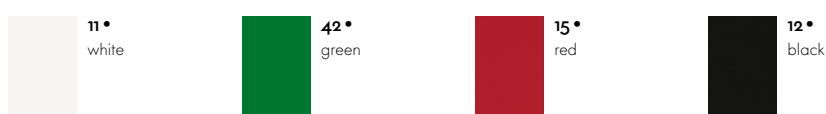

Panton Junior

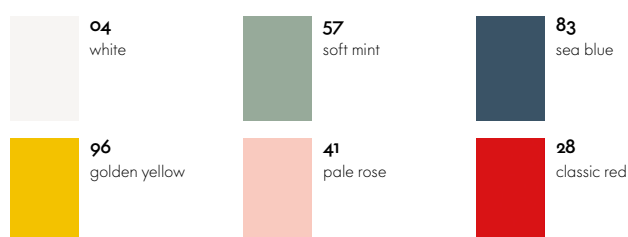

Physix

Frame

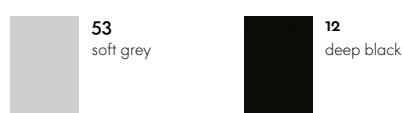

Rookie

Base and frame

Seat shell

Standard SP

Back and seat

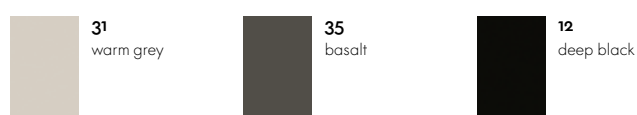

Stool-Tool



Tip Ton

Plastic chair

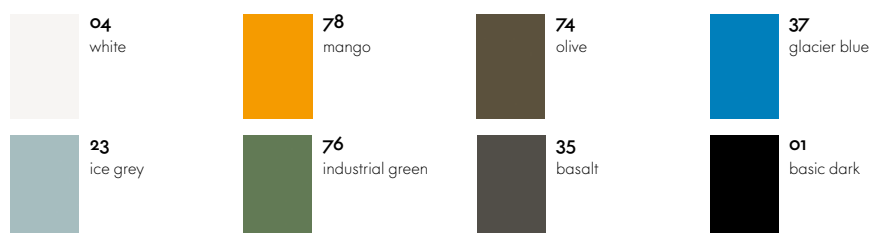

Toolbox

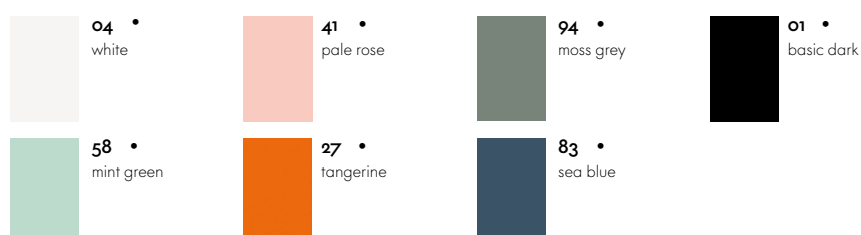

Uten.Silo

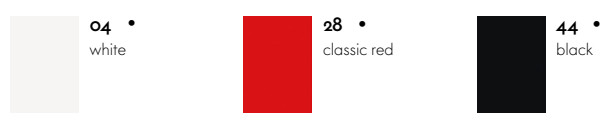

Recycled plastic

Depending on the material properties required of a product, Vitra chooses different types of plastic for the manufacture of its furniture. This always raises the issue of whether new, more ecological alternatives are available, which has led to the development of various recycled plastics. Depending on the type of product and its requirements, Vitra utilises high-quality recycling materials that stem from recyclable household waste, especially used packaging, or industrial waste.

With plastic obtained from recycled household waste, the natural shade of the processed material is dark grey (22 dark grey RE), interspersed with tiny specks of pigment. All other colours are obtained with artificial dye – and yet due to its randomly variable composition each batch of processed waste material has a different base shade, which can result in colour nuances in the dyed end products.

Chap
Chap Tray
Locker Box

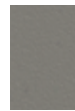

22
dark grey RE



12
deep black RE



83
sea blue RE



29
brick RE

HAL RE
Seat shell



31
warm grey RE

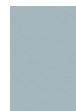

23
ice grey RE

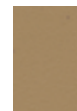

86
cardboard RE

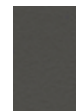

35
basalt RE

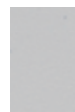

85
cotton white RE



14
ivy RE



29
brick RE



12
deep black RE

Tip Ton RE
all-plastic chair

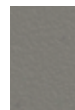

22
dark grey RE

Toolbox RE



58 •
mint green RE



94 •
moss grey RE



41 •
pale rose RE

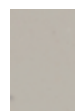

05 •
grey RE



83 •
sea blue RE



27 •
tangerine RE



01 •
basic dark RE

Fibreglass is a very robust and durable fibre composite made of polyester resin and glass fibres. The glass fibres visible in the plastic lend it a lively surface texture with a lustrous reflection and pleasant tactile qualities. This so-called 'fibreprint' may not only vary between different products but can also be a distinguishing characteristic of individual models of the same product. These tiny irregularities and distinctive features are what make each object a unique piece.

When manufacturing fibreglass, Vitra uses materials from Central Europe to avoid long transport distances.

Eames Fibreglass Side Chair Seat shell



05
Eames Sea
Foam Green



06
Eames Raw
Umber



04
Eames Elephant
Hide Grey



02
Eames Navy
Blue



09
Eames Classic
Red



03
Eames Red
Orange



08
Eames Ochre
Dark



07
Eames Ochre
Light



01
Eames Parch-
ment

Eames Fibreglass Armchair Seat shell



01
Eames Parch-
ment



05
Eames Sea
Foam Green















06
Eames Raw
Umber

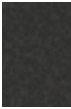
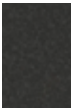
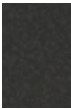

04
Eames Elephant
Hide Grey

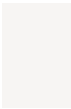
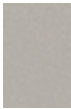
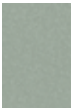
Polyurethane

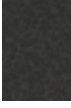
Polyurethane (PU) is a synthetic foam material used in a number of Vitra products. The cellular structure of PU foams can be varied to meet different requirements, ranging from flexible, elastic materials to solid, rigid components.

.03 .04 .04 Counter Seat shell	 78 mango	 10 bright red	 77 dark green	 01 basic dark
.05 Seat shell	 10 bright red	 77 dark green	 01 basic dark	
AIRLINE Back and seat	 01 basic dark			
Meda Gate Seat shell, polyurethane	 01 basic dark	 40 chocolate		
NesTable Tray	 52 • soft light	 42 • warm grey	 57 • soft mint	 23 • ice grey
	 19 • sea blue	 01 • basic dark	 10 • bright red	

Vitra most frequently uses aluminium and steel for metal components. Since 94% less energy is required to produce recycled aluminium in comparison to primary aluminium, Vitra utilises aluminium consisting of 95% recycled material whenever possible.

Depending on the product, metal surfaces are either powder-coated, chrome-plated, polished, galvanised or lacquered. A smooth or textured powder-coated finish provides colour and surface protection.

.03
Base



01
chrome



16
silver powder-coated (smooth)



55
black powder-coated (textured)

.04
Base



55
black powder-coated (textured)

.05
Base



•
stainless steel brushed



55
black powder-coated (textured)

Abalon
Abalon Table
Base



91
mint powder-coated (smooth)



12
deep black powder-coated (smooth)

AIRLINE
Base and armrests



05
light silver powder-coated (smooth)

AC 5 Group
Base and armrests



03
polished aluminium

Pivot Counter Stool
Pivot High Stool
Pivot Stool
Grand Executive & Grand Conference
Unix Chair
Base

Alcove
Alcove Plus
Tubular steel frame group 1

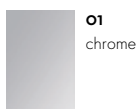

01
chrome

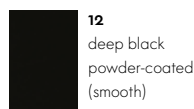

12
deep black
powder-coated
(smooth)

Tubular steel frame group 2

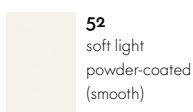

52
soft light
powder-coated
(smooth)



91
mint powder-
coated (smooth)

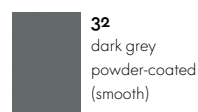

32
dark grey
powder-coated
(smooth)



06
Japanese red
powder-coated
(smooth)

AM Chair
Belleville Table
Base
Citizen
Tubular steel frame

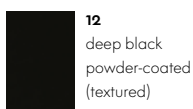

12
deep black
powder-coated
(textured)

Bistro Table
HAL Armchair Studio
HAL Studio
Super Fold Table
Trapèze
Base

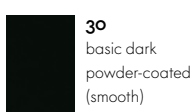

30
basic dark
powder-coated
(smooth)

Cité
Compas Direction
EM Table
Fauteuil de Salon
Fauteuil Direction
Fauteuil Direction Pivotant
Base/Base frame

Colour group 1



88
Prouvé Blanc
Colombe (Ecrû)
powder-coated
(smooth)



06
Japanese red
powder-coated
(smooth)

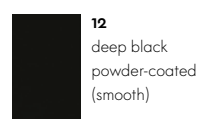

12
deep black
powder-coated
(smooth)

Colour group 2



13
Prouvé Gris
Vermeer powder-
coated (smooth)



18
Prouvé Blé Vert
powder-coated
(smooth)



41
Prouvé Bleu
Marcoule powder-
coated (smooth)



14
Prouvé Bleu
Dynastie powder-
coated (smooth)



94
Prouvé Métal Brut
powder-coated
(transparent,
smooth)

Coconut Chair
Eames Tandem Seating ETS
HAL Armchair Tube Stackable
Home Desk
La Chaise
Lobby Chair
Base

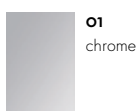

01
chrome

Eames Aluminium Group
Eames Soft Pad Group
Base

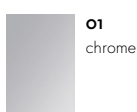

01
chrome



03
polished
aluminium

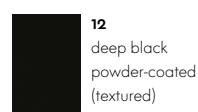

12
deep black
powder-coated
(textured)





Eames Contract Tables

Base

 04 white powder-coated (textured)	 01 chrome	 03 polished alumi- nium
 12 deep black powder-coated (textured)	 30 basic dark powder-coated (smooth)	



Eames Desk Unit EDU
Eames Storage Unit ESU

Panels

 83 • pale blue	 25 • mauve grey	 85 • fawn	 84 • Eames red
 86 • rusty orange			

Eames Fiberglass Chairs

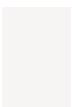
**Base DSR, DSX,
DAR, DAX, LAR**

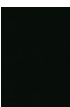
 04 white powder- coated (smooth)	 01 chrome	 30 basic dark powder-coated (smooth)
---	---	--

Eames Plastic Chairs

Base DAL, PACC, PSCC

 03 polished alumi- nium



Eames Plastic Chairs

Base (Outdoor)

 04 white powder- coated (smooth)	 30 basic dark powder-coated (smooth)			
 92 citron powder- coated (smooth)	 93 sky blue powder- coated (smooth)	 31 Eames Sea Foam Green powder- coated (smooth)	 24 dark green powder-coated (smooth)	

Eames Segmented Tables Dining
Eames Segmented Tables Meeting

Base

 01 chrome	 03 polished alumi- nium	 12 deep black powder-coated (textured)	 30 basic dark powder-coated (smooth)
---	--	--	--



Elliptical Table ETR
Plywood Group (DCM, LCM)

Base

 01 chrome	 30 basic dark powder-coated (smooth)
---	--

Grand Relax
Grand Sofà
Petit Repos
Repos & Grand Repos
Suita

Base

 03 polished alumi- nium	 30 basic dark powder-coated (smooth)
--	--

Guéridon
Guéridon Bas
Table S.A.M. Bois
Tabouret Bois
Linking elements

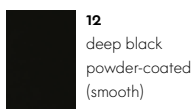

12
deep black
powder-coated
(smooth)

HAL
Base



01
chrome



30
basic dark
powder-coated
(textured)



49
ivory powder-
coated (textured)

HAL Soft
Moca
Base



01
chrome



30
basic dark
powder-coated
(textured)

ID Chair Concept
Base and ring armrests



03
polished
aluminium



53
soft grey
powder-coated
(textured)



30
basic dark
powder-coated
(textured)

ID Chair Concept
Supports for 2D/3D armrests



03
polished
aluminium



53 •
soft grey
powder-coated
(smooth)



30
basic dark
powder-coated
(smooth)

ID Visitor
Base



01
chrome



53
soft grey
powder-coated
(textured)



30
basic dark
powder-coated
(textured)

Landi Chair



10
matte anodised
aluminium

Lampe de Bureau
Rayonnage Mural
Tabouret Métallique
Sheet steel



88
Prouvé Blanc
Colombe (Ecrû)
powder-coated
(smooth)



06
Japanese red
powder-coated
(smooth)



41
Prouvé Bleu
Marcoule powder-
coated (smooth)



12
deep black
powder-coated
(smooth)

Petite Potence
Steel tube

Lounge Chair
Base (American cherry, Santos palisander, black-pigmented walnut)



03
polished
aluminium



03/12
aluminium polished/deep
black powder-coated
(smooth)

Base (white-pigmented walnut)



03
polished aluminium

Base (black ash)



12
deep black
powder-coated
(smooth)

Map Table
Modesty panel



52
soft light
powder-coated
(textured)

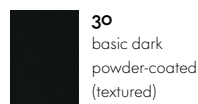

30
basic dark
powder-coated
(textured)

Map Table
Column bases



01
chrome

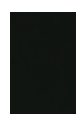

30
basic dark
powder-coated
(textured)

Meda Gate
Base and armrests



03
polished aluminium



05
light silver
powder-coated
(smooth)

MedaMorph
Base



01
chrome



03
polished
aluminium

MedaSlim
Base



01
chrome



03
polished
aluminium



30
basic dark
powder-coated
(smooth)

Metal Side Tables
Table top and base (Outdoor)

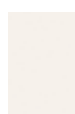

52
soft light
powder-coated
(textured)



23
ice grey
powder-coated
(textured)



95
galvanised



21
dim grey
powder-coated
(textured)



12
deep black
powder-coated
(textured)

Table top and base

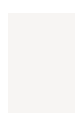

04
white powder-
coated (smooth)



40
chocolate powder-
coated (smooth)

NesTable
Base

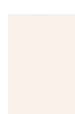

52
soft light
powder-coated
(textured)



42
warm grey
powder-coated
(textured)



57
soft mint
powder-coated
(textured)



23
ice grey
powder-coated
(textured)



19
sea blue
powder-coated
(textured)

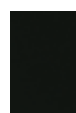

30
basic dark
powder-coated
(textured)



10
bright red
powder-coated
(textured)

Occasional Low Table
Base



40
chocolate
powder-coated
(textured)

Physix

Base



03
polished
aluminium



53
soft grey
powder-coated
(textured)



12
deep black
powder-coated
(textured)

Plate Dining Table

Plate Table

Base

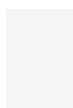

04
white
powder-coated
(textured)



30
basic dark
powder-coated
(textured)

Potence

Tabouret N° 307

Steel tube



88
Prouvé Blanc
Colombe (Ecrú)
powder-coated
(smooth)



12
deep black
powder-coated
(smooth)

Slow Chair

Base



03
polished
aluminium



40
chocolate
powder-coated
(smooth)

Softshell Chair

Base



03
polished
aluminium



30
basic dark
powder-coated
(smooth)

Standard
Standard SP

Base



88
Prouvé Blanc
Colombe (Ecrú)
powder-coated
(smooth)



13
Prouvé Gris
Vermeer
powder-coated
(smooth)



18
Prouvé Blé Vert
powder-coated
(smooth)



06
Japanese red
powder-coated
(smooth)



94
Prouvé Métal Brut
powder-coated
(transparent,
smooth)



41
Prouvé Bleu
Marcoule
powder-coated
(smooth)



14
Prouvé Bleu
Dynastie powder-
coated (smooth)



12
deep black
powder-coated
(smooth)

Tyde 2

Base

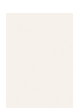

52
soft light
powder-coated
(smooth)



12
deep black
powder-coated
(smooth)

Wire Chair

Seat and base



01
chrome

Wire Chair

Seat and base (Outdoor)

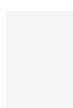

04
white powder-
coated (smooth)



30
basic dark
powder-coated
(smooth)



92
citron powder-
coated (smooth)

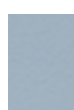

93
sky blue powder-
coated (smooth)



31
Eames Sea Foam
Green powder-
coated (smooth)



24
dark green
powder-coated
(smooth)

Wood is characterised by variations in grain, texture and colour, making each wooden furnishing a unique object. Vitra has strict quality standards for the woods selected for its products and uses wood from several trees for the manufacture of a single furniture object made of solid wood. As a result, every piece has a lively and distinctive appearance.

The solid woods used by Vitra are mainly sourced in Europe and have an oiled or lacquered finish, depending on their application. Exposure to light will alter the colour of wood over time.

Chaise Tout Bois
East River Chair
HAL Lounge Chair

Base

HAL

Base HAL Wood, Ply Wood, Soft Wood

Tabouret Haut

Seat and base



10
natural oak,
with protective
varnish



04
dark stained solid
oak, with protective
varnish

Coffee Table

Base

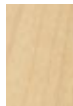

54
maple



walnut



68
black ash

Compas Direction
Eames Segmented Tables Dining
EM Table
Occasional Low Table
Occasional Table LTR

Table top



70
natural solid
oak, oiled



75
solid American
walnut, oiled



04
dark stained solid
oak, with protective
varnish

Fauteuil Direction Pivotant
Fauteuil de Salon
Fauteuil Direction

Armrests

Guéridon
Guéridon Bas
Table S.A.M. Bois

Table top and legs

Tabouret Bois

Seat and base

Eames Coffee Table

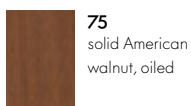
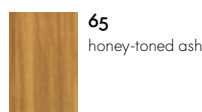
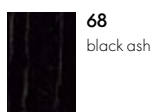
Table top**Base**

Eames Fiberglass Chairs

Eames Plastic Chairs

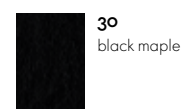
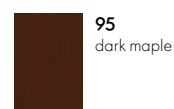
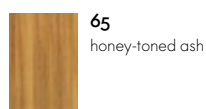
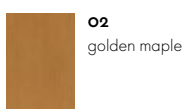
Base DSW, DAW

Freeform Sofa

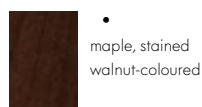
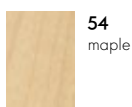
Legs

La Chaise

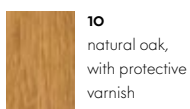
Base

Nelson Bench

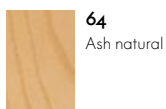
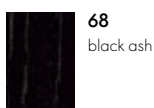
Seat**Seating surface & base**

Organic Chair

Legs

Plate Dining Table

Plate Table

Table top

Rayonnage Mural

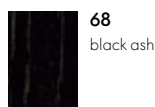
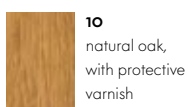
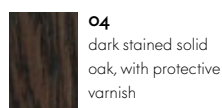
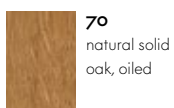
Shelves

Tabouret N° 307

Seat

Stools

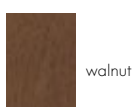

Wire Chair

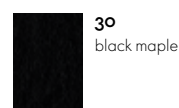
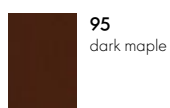
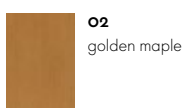
Base

Complex industrial methods are used to produce sheets of wood veneer, which are further processed by hand. In most cases, wood from a single tree is utilised for a piece of furniture to ensure the uniform appearance of all surfaces.

With only two exceptions, Vitra exclusively purchases veneers with a certificate of sustainability from European producers. Vitra's veneers are finished with a protective lacquer; exposure to light will alter the colour over time.

Abalon Table
 Belleville Table
 Bistro Table
 Eames Contract Tables
 Super Fold Table
Table top

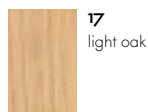

17
light oak

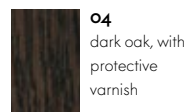

04
dark oak, with protective varnish

AIRLINE
Backrest and seat

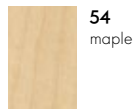

54
maple

Alcove
 Alcove Plus
Table top / Tray

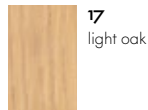

17
light oak

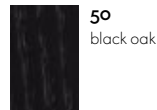

50
black oak

Belleville Chair
Seat shell

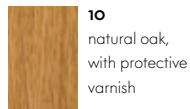

10
natural oak, with protective varnish

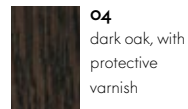

04
dark oak, with protective varnish

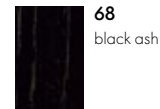

68
black ash

Butterfly Stool

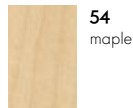

54
maple

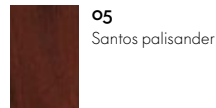

05
Santos palisander

Chaise Tout Bois
 Moca
Backrest and seat

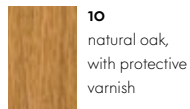

10
natural oak, with protective varnish

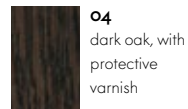

04
dark oak, with protective varnish

EM Table
Table top

HAL
Seat shell HAL Ply

Eames Desk Unit EDU

Table top

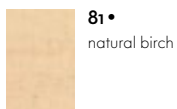

Eames Storage Unit ESU

Shelf

Eames Elephant (Plywood)

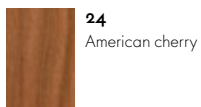

Joyn

Tyde 2

Table tops

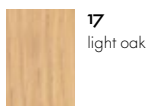

Eames Segmented Tables Meeting

Table top

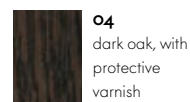
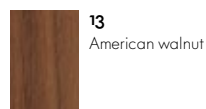
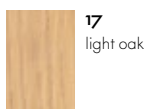

Lounge Chair

Seat and backrest shell

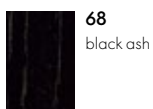
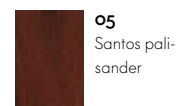
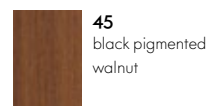
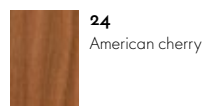
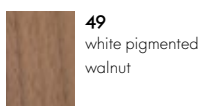

MedaMorph

Table top

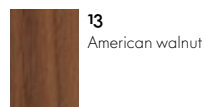
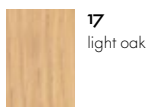

Plywood Group

Back, seat and base (LCW)

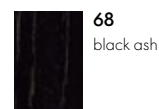
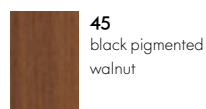
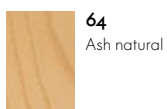

Plywood Group

Back, seat and base (LCW)

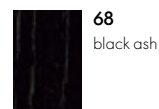
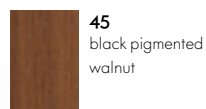
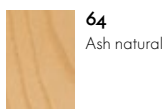

Standard

Back and seat,

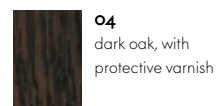
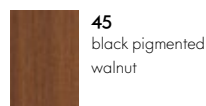
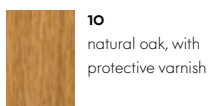

Wooden Side Tables

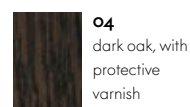
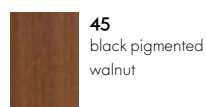
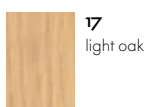

Medium-density fibreboard, also known as MDF board, consists primarily of debarked coniferous wood broken down into fine fibres. MDF is a wood-based material with a uniform structure both lengthwise and crosswise. Its edges are hard and smooth,

making it possible to cut clean profiles. Vitra is an industry leader in the development and application of powder coating methods for MDF. Powder coating produces an even, robust surface finish with seamless edges, making it ideal for constructions with cut-outs or for complex corner joints.

Abalon Table

Table top

Alcove

Alcove Plus

Table top / Tray

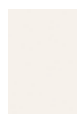

52
soft light
powder-coated
(textured)

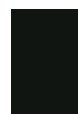

30
basic dark
powder-coated
(textured)

Plate Dining Table

Plate Table

Table top

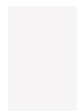

04
white powder-
coated



30
basic dark
powder-coated
(textured)

Wood materials with a melamine resin surface coating are robust and durable. They come in a variety of colours, are easy to clean, and provide a less expensive alternative to wood veneer or solid wood.

Alcove
Alcove Plus
Table top / Tray



Joyn
Map Table
MedaMorph
Tyde 2
Table top

Bistro Table
Belleville Table
Eames Contract Tables
Super Fold Table
Table top

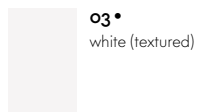

High-pressure laminate, abbreviated as HPL, is composed of layers of paper that are impregnated with phenolic and melamine resins and bonded together with a protective overlay under high pressure and heat, and applied to a substrate. The resulting surfaces are simple to clean and maintain, and they are also lightfast, odorless and resistant to alcohol, organic solvents and water.

Dining Table
Eames Contract Tables
Eames Segmented Tables Dining
Eames Segmented Tables Meeting
Home Desk
Table top

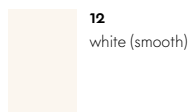

Elliptical Table ETR
Table top

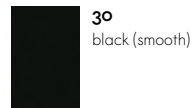
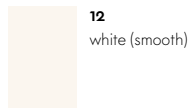

EM Table
Table top

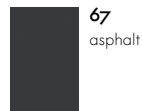
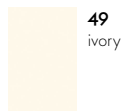

Occasional Table LTR
Table top

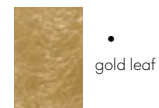
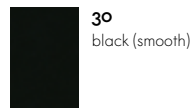
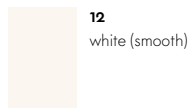

Trapèze
Table top

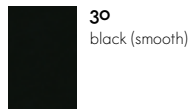

Tyde 2
Table top



Solid core panels are composed of layers of paper that are impregnated with phenolic and melamine resins and bonded together with a protective overlay under high pressure and heat. The resulting surfaces are simple to clean and maintain, and they are also lightfast, odorless and resistant to alcohol, organic solvents and water. In contrast to HPL on substrate, solid core panels are also suitable for outdoor use.

AIRLINE

Table unit

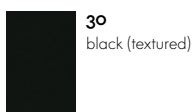

Belleville Table
Bistro Table
Super Fold Table

Table tops

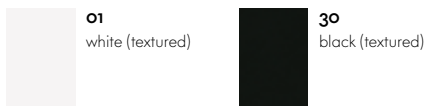

Eames Contract Tables

Table top

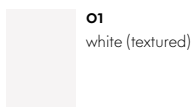

Linoleum is derived from natural and renewable raw materials. This pliant, high-quality substance has a pleasant touch, and fingerprints are almost imperceptible on its surface. It is easy to care for and collects very little dust in comparison to other surface materials, thanks to its anti-static characteristics.

Suita
Tray inlay

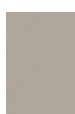

01
pebble



02
charcoal

Bonded leather

Bonded leather is made up of remnants from Vitra furniture production: leather fibres and offcuts are shredded and bound with vegetable tanning agents, natural rubber, fats and water, then pressed to extract water and dried. Bonded leather allows a judicious use of resources as it is processed from small scraps that would otherwise have no further use. It can be cleaned with a damp cloth.

Bonded leather is available in 5 colours (variants in natural hues with protective sealant; colour variants with coated finish).

Repad
Bonded Leather



03
clay



04
light sage



05
dark red



06
jade



02
natural black

Whenever possible, the marble used by Vitra is a premium quality Carrara marble. Since marble is a natural material, every marble table top has its own unique colour and texture. Vitra treats the marble surfaces with a high-quality sealer to protect them from water, oil, grease and moisture. This sealer penetrates deep into the stone, while still allowing it to breathe.

Unlike the effect of varnish sealing, the stone retains its natural appearance and particularly its colour. Even with this treatment, marble remains a relatively sensitive surface that develops a patina with use.

Eames Coffee Table
Occasional Table LTR
Plate Dining Table
Plate Table
Table top



50
marble Carrara

Glass

Vitra currently uses so-called float glass. This is manufactured by feeding molten glass into a bath of molten tin, where it forms a floating ribbon that then cools. Special heat treatment renders the glass shock and impact resistant (single-pane safety glass according to EN 12150-1).

Painting the underside in a variety of colours, along with a satin surface finish, gives the material a fresh and unusual appearance.

Plate Dining Table
Table top

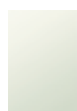

82
white satin finish



83
light grey satin finish

Cork

Cork, a natural rigid foam harvested from the bark of the cork oak, is distinguished by its light weight and pleasant tactile qualities. The robust, fire-resistant material varies in both colour and texture, so that every piece of furniture or accessory made from cork is a unique, one-of-a-kind object.

Cork Family



•
untreated cork

Corrugated Cardboard

Derived from a renewable resource, this natural material is layered and finished with strong side edges to make a small number of Vitra products. In this form, it maintains a surprising degree of stability and rigidity.

Wiggle Side Chair & Wiggle Stool



•
natural



•
natural

Fleece

The polyester fleece material used by Vitra is thermoformed by the application of heat and pressure and is 100% recyclable. It has a slightly fleecy texture and is somewhat pliable without losing its shape. Polyester fleece has sound-proofing qualities and its relatively fine-pored surface prevents the easy penetration of liquids.

Type 2
Cable tray



01
pebble grey



10
classic grey

East River Chair

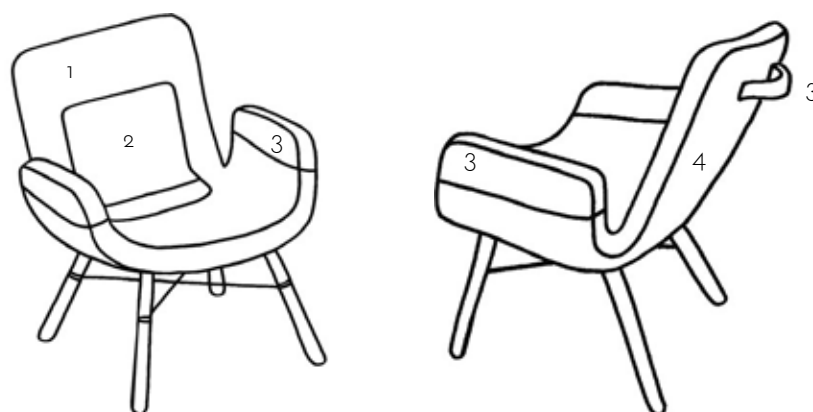

	1	2	3	4
Light mix 01	 <p>65 Laser RE - ice blue/cream</p>	 <p>05 Plano - cream white/sierra grey</p>	 <p>71 Leather Premium F - sand</p>	 <p>71 Hopsak - yellow/pastel green</p>
Red mix 02	 <p>74 Laser RE - nude/light red</p>	 <p>96 Plano - red/cognac</p>	 <p>71 Leather Premium F - sand</p>	 <p>63 Hopsak - red/poppy red</p>
Green mix 04	 <p>63 Laser RE - warm grey/cream</p>	 <p>70 Hopsak - grass green/forest</p>	 <p>67 Leather Premium F - asphalt</p>	 <p>69 Plano - dark grey</p>
Blue mix 05	 <p>20 Laser RE - ice blue/moor brown</p>	 <p>66 Plano - nero</p>	 <p>67 Leather Premium F - asphalt</p>	 <p>84 Hopsak - blue/moor brown</p>

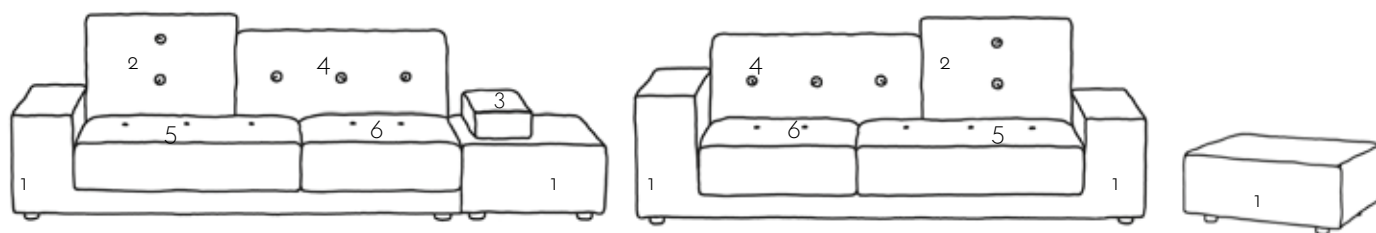

1 2 3 4 5 6

Fabric mix „The Pebble Greys“

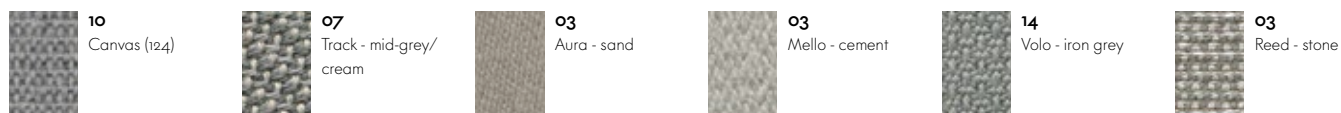

Fabric mix „The Sea Greens“

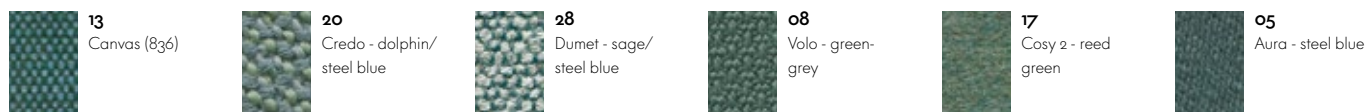

Fabric mix „The Earth Reds“

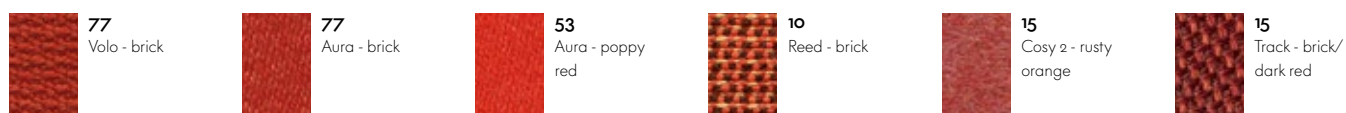

Fabric mix „The Antarctic Blues“

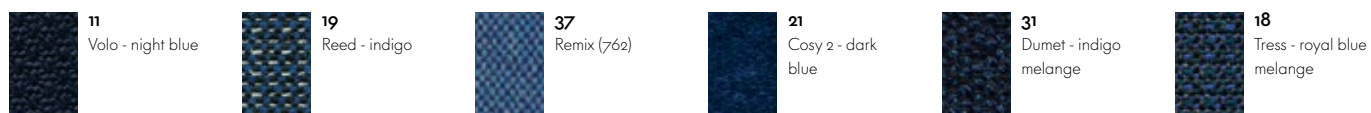

Slow Chair & Ottoman

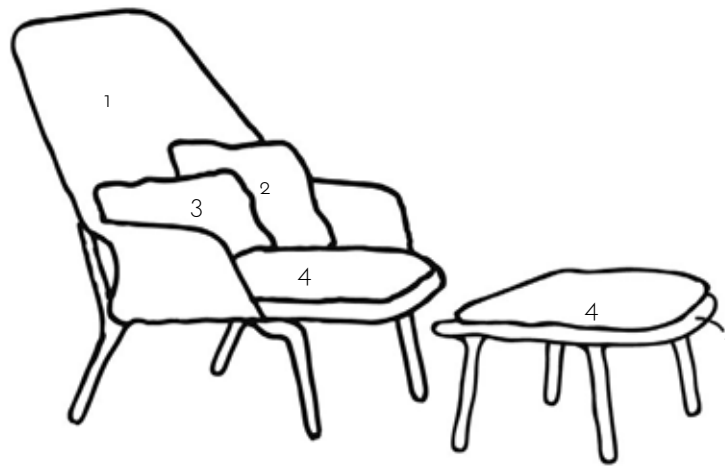

1 Slow Chair & Ottoman 2 Slow Chair 3 Slow Chair 4 Slow Chair & Ottoman

Slow Chair - red/cream



Tricot - red/
cream



Tonus - moss
green

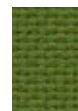

09
Laser - green



Coda - cream

Slow Chair - brown/cream

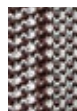

Tricot - brown/
cream



03
Panamone -
moss grey



09
Laser - green

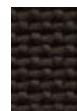

02
Panamone - dark
brown

Slow Chair - brown



Tricot - brown



Intreccio - anth-
racite



Tonus - moss-
green



13
Aura - blackberry

Slow Chair - black



Tricot - black



Intreccio -
anthracite



Tonus - moss-
green

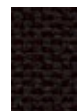

04
Laser - black

Slow Chair - blue/green



Tricot - blue/
green



77
Hopsak - nero/
forest



04
Twill - ink blue



22
Laser - dark
blue/forest

vitra.